



Welcome to the **Isocom Components** information booklet!

Inside you will find details of our extensive range of optocouplers and other optoelectronics devices including:

4 Pin DIL & SMD Optocouplers	pg 4
6 Pin DIL & SMD Optocouplers	pg 5
8 Pin DIL & SMD Optocouplers	pg 6
16 Pin DIL & SMD Optocouplers	pg 7
8 & 16 Pin Symmetrical Terminal Configuration DIL & SMD Optocouplers	pg 8
Special Purpose 6 Pin DIL & SMD Optocouplers (<i>Triac & Schmitt Trigger</i>)	pg 9
Small Outline Package SMD Optocouplers	pg 10
Half Pitch Packages	pg 12
Optically Coupled MOSFET Solid State Relays	pg 13
Optocoupler Product Drop-In Replacements	pg 14
Optocoupler Mini Flat Pack Cross Reference List	pg 15
MOSFET Relays & Cross Reference List	pg 16
Sample Request Form	pg 18
Ordering Information	pg 19

In addition, **Isocom Components** is committed to expanding and enhancing its product range so please contact us if your part number is not shown or if you require technical assistance.

Isocom Components has been a leading supplier of infrared optoelectronic devices for over fifteen years and product families include all popular commercial optocoupler industry standard types including many no longer supplied by other manufacturers. Industry standard and custom switches for motion sensing, position sensing, and encoding also form a substantial part of our range.

Isocom Components undertakes final assembly, marking, lead forming, testing, and quality control at its facility in Hartlepool in the North East of England. Original components are sourced from world class approved suppliers in the Far East and elsewhere to ensure cost competitiveness and the highest quality standards.

We offer the shortest manufacturing lead times in the world for many parts and are proud of our fast turnaround capability whilst maintaining our excellent product quality.

Why settle for lengthy lead times when we can deliver your components at a time when you need them?

For all the latest news and new product offerings please visit our website at www.isocom.com

**Special Selections • Just-In-Time Delivery • Superior Service
Short Lead Times • Unbeatable Quality • Technical Support**

4 Pin DIL & SMD Optocouplers

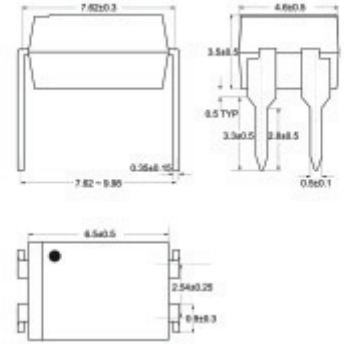

Transistor Output

AC Input

Darlington Output

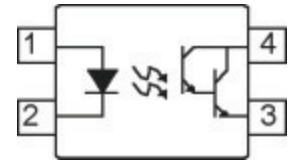
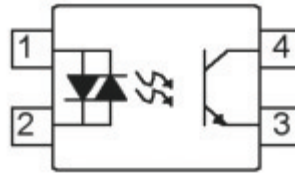
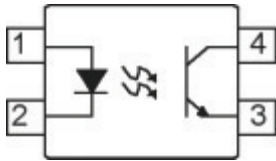

Description

The 4 pin transistor output series of optically coupled isolators consist of an infrared light emitting diode and a NPN silicon phototransistor in a space efficient dual-in-line plastic package.

Description

The 4 pin AC input series of optically coupled isolators consist of two infrared light emitting diodes connected in inverse parallel and a NPN silicon phototransistor in a space efficient dual-in-line plastic package.

Description

The 4 pin darlington output series of optically coupled isolators consist of an infrared light emitting diode and a NPN silicon photodarlington to give superior gain in a space efficient dual-in-line plastic package.

Features

- High Current Transfer Ratio
- High Isolation Voltage
- All electrical parameters 100% tested
- Custom electrical selections available

Features

- High Isolation Voltage
- AC or polarity insensitive input
- All electrical parameters 100% tested
- Custom electrical selections available

Features

- High Current Transfer Ratio
- High Isolation Voltage
- All electrical parameters 100% tested
- Custom electrical selections available

Applications

- Switch mode power supplies
 - Household appliances
 - Computer terminals
- Industrial systems controllers
 - Measuring instruments
- Signal transmission between systems of different potentials and impedances

4 Pin DIL & SMD Optocouplers (Part Numbers)

Transistor Output

ISP321-1
ISP521-1
ISP621-1
ISP624-1
ISP817
ISP817-1
ISP817-2
ISP817-3
ISP817A
ISP817B
ISP817C
ISP817D
PS2501-1
SFH615A-1
SFH615A-2
SFH615A-3
SFH615A-4
SFH617A-1
SFH617A-2
SFH617A-3
SFH617A-4

SFH617G-1
SFH617G-2
SFH617G-3
SFH617G-4
SFH618A-1
SFH618A-2
SFH618A-3
SFH618A-4
TIL191
TIL191A
TIL191B
TLP321-1
TLP521-1
TLP621-1
TLP624-1

AC Input

ISP620-1
ISP626-1
ISP814
ISP814-1
ISP814-2
ISP814-3
PS2505-1
SFH620A-1
SFH620A-2
SFH620A-3
SFH628A-1
SFH628A-2
SFH628A-3
TIL194
TIL194A
TIL194B
TLP620-1
TLP626-1

Darlington Output

ISP627-1
ISP815
ISP815-1
ISP815-2
ISP815-3
PS2502-1
TIL197
TIL197A
TIL197B
TLP627-1

6 Pin DIL & SMD Optocouplers

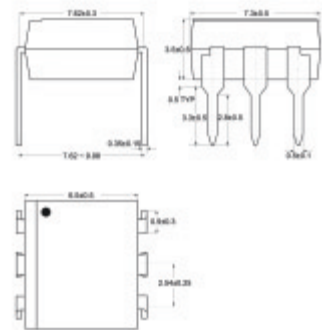
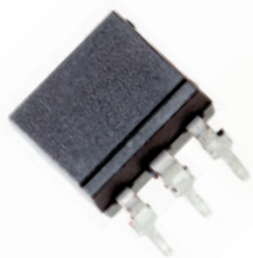

Transistor Output

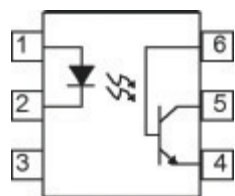

AC Input

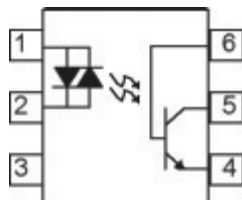

Darlington Output

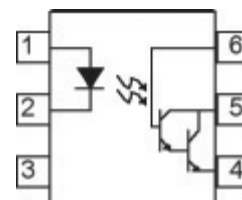

Description

The 6 pin transistor output series of optically coupled isolators consist of an infrared light emitting diode and a NPN silicon phototransistor in a dual-in-line plastic package.

Description

The 6 pin AC input series of optically coupled isolators consist of two infrared light emitting diodes connected in inverse parallel and a NPN silicon phototransistor in a dual-in-line plastic package.

Description

The 6 pin darlington output series of optically coupled isolators consist of an infrared light emitting diode and a NPN silicon photodarlington to give superior gain in a dual-in-line plastic package.

Features

- High Current Transfer Ratio
- High Isolation Voltage
- All electrical parameters 100% tested
- Custom electrical selections available

Features

- High Isolation Voltage
- AC or polarity insensitive input
- All electrical parameters 100% tested
- Custom electrical selections available

Features

- High Current Transfer Ratio
- High Isolation Voltage
- All electrical parameters 100% tested
- Custom electrical selections available

Applications

- Switch mode power supplies
 - Household appliances
 - Computer terminals
- Industrial systems controllers
 - Measuring instruments
- Signal transmission between systems of different potentials and impedances

6 Pin DIL & SMD Optocouplers (Part Numbers)

Transistor Output

4N25
4N26
4N27
4N28
4N35
4N36
4N37
4N38
4N38A
CNX62A*
CNX72A
CNX82A*
CNX83AG
CNY17-1
CNY17-2
CNY17-3
CNY17-4
CNY17-5
CNY17F-1*
CNY17F-2*
CNY17F-3*
CNY17F-4*

CNY17F-5*
CNY75A
CNY75B
CNY75C
CQY80
H11A1
H11A2
H11A3
H11A4
H11A5
H11AV1
H11AV2
H11AV3
IL1
IL2
IL5
IL74
IS1
IS201
IS202
IS203
IS204

IS204-1
IS204-2
IS204-3
IS205*
IS205-1*
IS205-2*
IS205-3*
IS206*
IS5
IS74
MCT2
MCT210
MCT2200
MCT2201
MCT2202
MCT270
MCT271
MCT272
MCT273
MCT274
MCT275
MCT276

MCT277
MCT2E
MOC8100
MOC8101*
MOC8102*
MOC8103*
MOC8104*
MOC8105*
MOC8106*
MOC8107*
MOC8108*
MOC8111*
MOC8112*
MOC8113*
SFH600-0
SFH600-1
SFH600-2
SFH600-3
SFH600-4
SFH601-1
SFH601-2
SFH601-3

SFH601-4
SFH601-5
SFH609-1
SFH609-2
SFH609-3
SFH609-4
TIL111
TIL112
TIL114
TIL116
TIL117

AC Input

CNY35
H11AA1
H11AA2
H11AA3
H11AA4
IS604
IS733

Darlington Output

4N29
4N30
4N31
4N32
4N33
H11B1
H11B2
H11B3
H11G1
H11G2
H11G3
IS4N46
IS660
IS661
IS662
IS7000
IS725
ISPD60*
ISPD61*
ISPD62*
ISPD63*
ISPD64*

ISPD65*
MCA2230
MCA2231
MCA2255
MCA230
MCA231
MCA255
MOC8020*
MOC8021*
MOC8030*
MOC8050*
MOC8080
TIL113
TIL119*

*Base lead not connected

8 Pin DIL & SMD Optocouplers

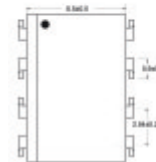
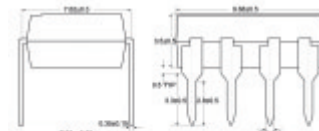
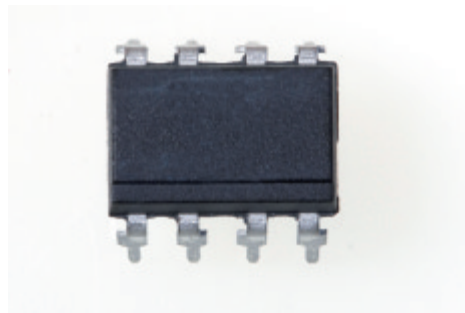

Transistor Output

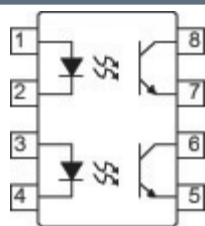

AC Input

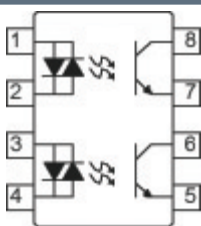

Darlington Output

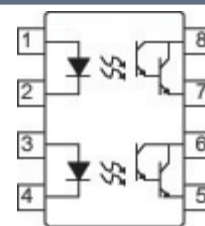

Description

The 8 pin transistor output series of optically coupled isolators consist of two infrared light emitting diodes and two NPN silicon phototransistors in a dual-in-line plastic package.

Description

The 8 pin AC input series of optically coupled isolators consist of two pairs of infrared light emitting diodes connected in inverse parallel and two NPN silicon phototransistors in a dual-in-line plastic package.

Description

The 8 pin darlington output series of optically coupled isolators consist of two infrared light emitting diodes and two NPN silicon photodarlington to give superior gain in a dual-in-line plastic package.

Features

- High Current Transfer Ratio
- High Isolation Voltage
- Two independent channels
- All electrical parameters 100% tested
- Custom electrical selections available

Features

- High Isolation Voltage
- AC or polarity insensitive input
- Two independent channels
- All electrical parameters 100% tested
- Custom electrical selections available

Features

- High Current Transfer Ratio
- High Isolation Voltage
- Two independent channels
- All electrical parameters 100% tested
- Custom electrical selections available

Applications

- Switch mode power supplies
 - Household appliances
 - Computer terminals
- Industrial systems controllers
 - Measuring instruments
- Signal transmission between systems of different potentials and impedances

8 Pin DIL & SMD Optocouplers Part Numbers

Transistor Output

ISP321-2
ISP521-2
ISP621-2
ISP624-2
ISP827
ISP827-1
ISP827-2
ISP827-3
PS2501-2
TIL192
TIL192A
TIL192B
TLP321-2
TLP521-2
TLP621-2
TLP624-2

AC Input

ISP620-2
ISP626-2
ISP824
PS2505-2
TIL195
TIL195A
TIL195B
TLP620-2
TLP626-2

Darlington Output

ISP825
ISP825-1
ISP825-2
ISP825-3
PS2502-2
TIL198
TIL198A
TIL198B

16 Pin DIL & SMD Optocouplers

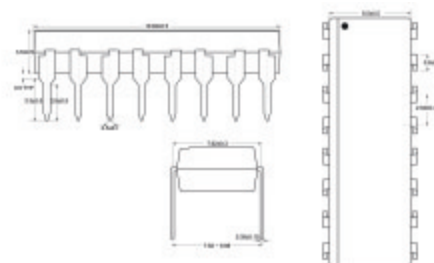
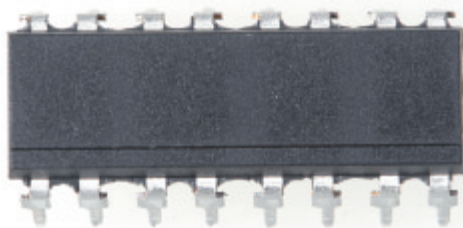

Transistor Output

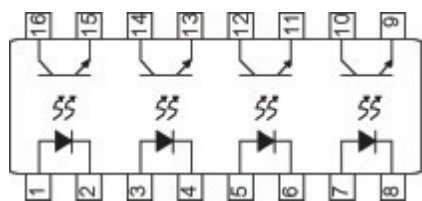

AC Input

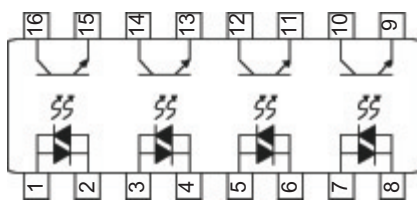

Darlington Output

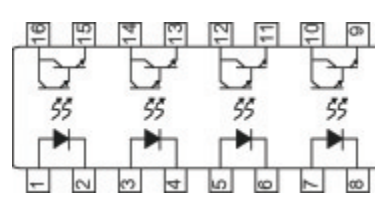

Description

The 16 pin transistor output series of optically coupled isolators consist of four infrared light emitting diodes and four NPN silicon phototransistors in a dual-in-line plastic package.

Description

The 16 pin AC input series of optically coupled isolators consist of four pairs of infrared light emitting diodes connected in inverse parallel and four NPN silicon phototransistors in a dual-in-line plastic package.

Description

The 16 pin darlington output series of optically coupled isolators consist of four infrared light emitting diodes and four NPN silicon photodarlington to give superior gain in a dual-in-line plastic package.

Features

- High Current Transfer Ratio
- High Isolation Voltage
- Four independent channels
- All electrical parameters 100% tested
- Custom electrical selections available

Features

- High Isolation Voltage
- AC or polarity insensitive input
- Four independent channels
- All electrical parameters 100% tested
- Custom electrical selections available

Features

- High Current Transfer Ratio
- High Isolation Voltage
- Four independent channels
- All electrical parameters 100% tested
- Custom electrical selections available

Applications

- Switch mode power supplies
 - Household appliances
 - Computer terminals
- Industrial systems controllers
 - Measuring instruments
- Signal transmission between systems of different potentials and impedances

16 Pin DIL & SMD Optocouplers (Part Numbers)

Transistor Output

ISP321-4
ISP521-4
ISP621-4
ISP624-4
ISP847
ISP847-1
ISP847-2
ISP847-3
PS2501-4
TIL193
TIL193A
TIL193B
TLP321-4
TLP521-4
TLP621-4
TLP624-4

AC Input

ISP620-4
ISP626-4
ISP844
PS2505-4
TIL196
TIL196A
TIL196B
TLP620-4
TLP626-4

Darlington Output

ISP845
ISP845-1
ISP845-2
ISP845-3
PS2502-4
TIL199
TIL199A
TIL199B

Special Purpose 6 Pin DIL & SMD Optocouplers

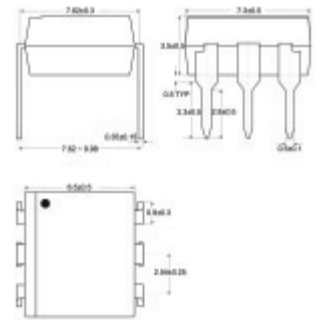
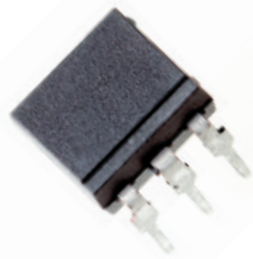

Random Phase Triac

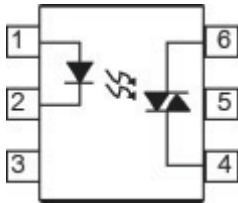

Zero Crossing Triac

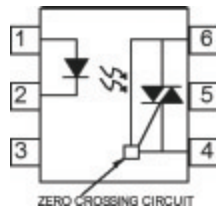

Schmitt Trigger

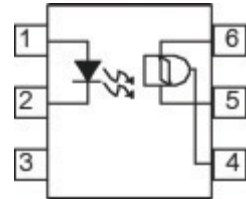

Description

The non-zero voltage crossing triac series are optically coupled isolators consisting of a Gallium Arsenide infrared emitting diode coupled with a light activated silicon bilateral switch performing the functions of a triac mounted in a standard 6 pin dual-in-line package.

Description

The zero voltage crossing triac series are optically coupled isolators consisting of a Gallium Arsenide infrared emitting diode coupled with a monolithic silicon detector performing the functions of a zero crossing bilateral triac mounted in a standard 6 pin dual-in-line package.

Description

The Schmitt Trigger series are optically coupled isolators consisting of a Gallium Arsenide infrared emitting diode and a Microprocessor Compatible Schmitt trigger output mounted in a standard 6 pin dual-in-line package.

Features

- High Isolation Voltage
- Up to 600V Peak Blocking Voltage
- High dV/dt
- All electrical parameters 100% tested
- Custom electrical selections available

Features

- High Isolation Voltage
- Up to 800V Peak Blocking Voltage
- Zero voltage crossing
- High dV/dt
- All electrical parameters 100% tested
- Custom electrical selections available

Features

- High Isolation Voltage
- High data rate
- Microprocessor compatible drive
- Fast switching
- Wide supply voltage capability
- Guaranteed on / off threshold hysteresis

Applications

- CRT's
- Power Triac Driver
 - Motors
- Dimmer Switch
- Consumer Appliances
 - Printers

- Logic to logic isolator
- Line receiver
- Programmable current level sensor
- AC to TTL conversion
- Digital programming of power supplies
- Interfaces computers with peripherals

Special Purpose 6 Pin DIL & SMD Optocouplers (Part Numbers)

Random Phase Triac

H11J1
H11J2
H11J3
H11J4
H11J5
IS3009
IS3010
IS3011
IS3012
IS3020
IS3021
IS3022
IS3023
IS3051
IS3052
IS6003
IS6005
IS6010
IS6015
IS6030
IS607

IS608
MOC3009
MOC3010
MOC3011
MOC3012
MOC3020
MOC3021
MOC3022
MOC3023
MOC3051
MOC3052

Zero Crossing Triac

IS3030
IS3031
IS3032
IS3033
IS3040
IS3041
IS3042
IS3043
IS3060
IS3061
IS3062
IS3063
IS3080
IS3081
IS3082
IS3083
IS620
IS621
IS622
IS623
MOC3030

MOC3031
MOC3032
MOC3033
MOC3040
MOC3041
MOC3042
MOC3043
MOC3060
MOC3061
MOC3062
MOC3063
MOC3080
MOC3081
MOC3082
MOC3083

Schmitt Trigger

H11L1
H11L2
H11L3
H11L4
IS609
IS900
MOC5007
MOC5008
MOC5009

Small Outline Package SMD Optocouplers

Transistor Output

AC Input

Darlington Output

HV Darlington Output

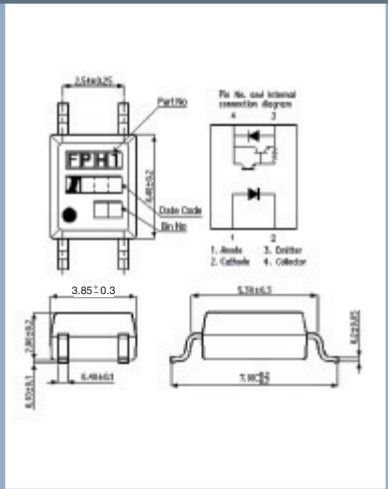
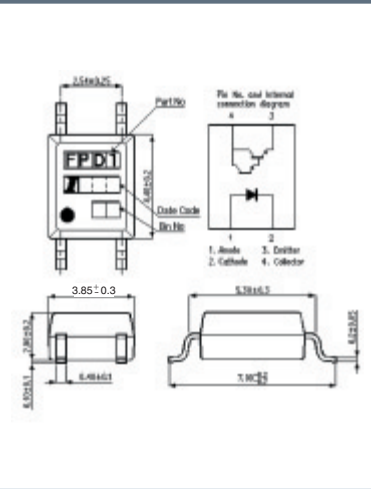
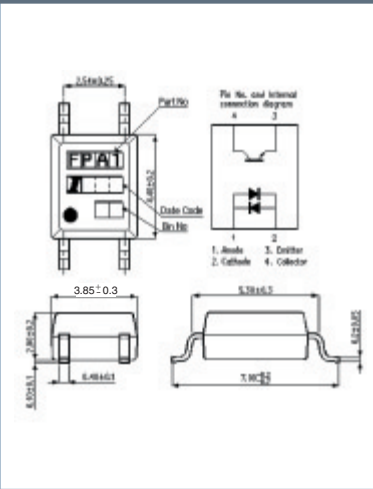
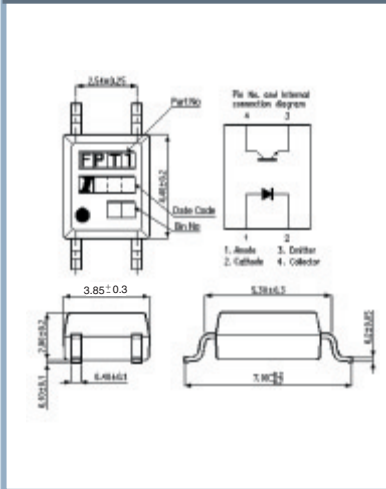

Description

Description

Description

Description

The 4 pin transistor output series of optically coupled isolators consist of an infrared light emitting diode and a NPN silicon phototransistor in a space efficient plastic package.

The 4 pin AC input series of optically coupled isolators consist of two infrared light emitting diodes connected in inverse parallel and a NPN silicon phototransistor in a space efficient plastic package.

The 4 pin darlington output series of optically coupled isolators consist of an infrared light emitting diode and a NPN silicon photodarlington in a space efficient plastic package.

The 4 pin high voltage darlington output series of optically coupled isolators consist of an infrared light emitting diode and a high voltage NPN silicon photodarlington which has an integral base-emitter resistor (to optimise switching speed and elevated temperature characteristics) in a space efficient plastic package.

Features

Features

Features

Features

- Marked as FPT1
- Current Transfer Ratio min. 50%
- All electrical parameters 100% tested

- Marked as FPA1
- Current Transfer Ratio min. 20%
- All electrical parameters 100% tested

- Marked as FPD1
- Current Transfer Ratio min. 600%
- All electrical parameters 100% tested

- Marked as FPH1
- Current Transfer Ratio min. 1000%
- High collector-emitter voltage
- All electrical parameters 100% tested

Applications

- Switch mode power supplies
 - Household appliances
 - Computer terminals
- Industrial systems controllers
 - Measuring instruments
- Signal transmission between systems of different potentials and impedances



Small Outline Package SMD Optocouplers

Part Numbers

Transistor Output	AC Input	Darlington Output	HV Darlington Output
IS121 IS181 IS2701-1 IS357	IS126 IS2705-1 IS354	IS2702-1 IS355	IS127 IS2732-1 IS452

...plus many more. If your required part number is not shown please contact us to discuss your requirements. All parts conform to the EU RoHS Directive 2002/95/EC.

Lead Form & Packaging Options

- All devices are supplied in surface mount lead form and in Tape and Reel packaging.

For Price & Delivery

- Call ISOCOM COMPONENTS direct on +44 (0)1429 863609 or email your requirements to sales@isocom.co.uk, or
- Contact your local ISOCOM COMPONENTS distributor. Visit www.isocom.com for details.

Taping Dimensions

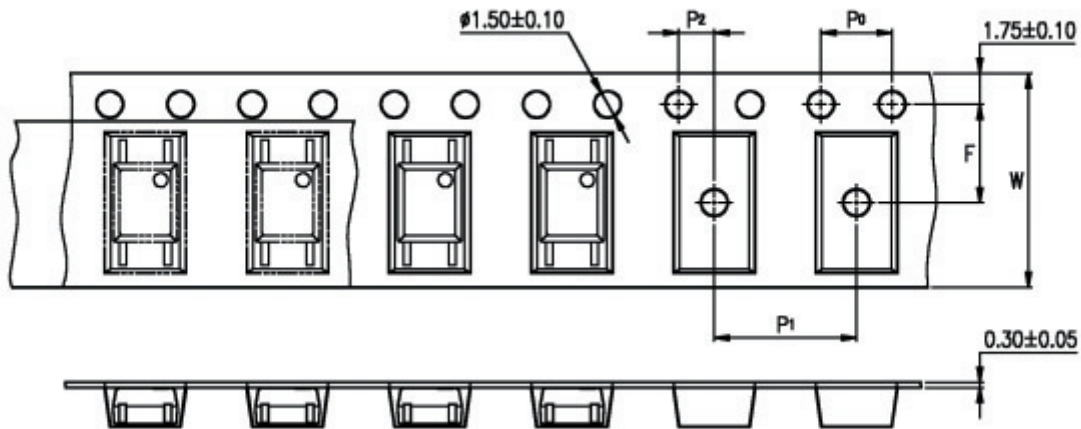

Description	Symbol	Dimensions in mm (inches)
Tape wide	W	12 + ₀ .3 (.47)
Pitch of sprocket holes	P ₀	4 + ₀ .1 (.15)
Distance of compartment	F P ₂	5.5 + ₀ .1 (.217) 2 + ₀ .1 (.079)
Distance of compartment to compartment	P ₁	8 + ₀ .1 (.315)

Half Pitch Packages

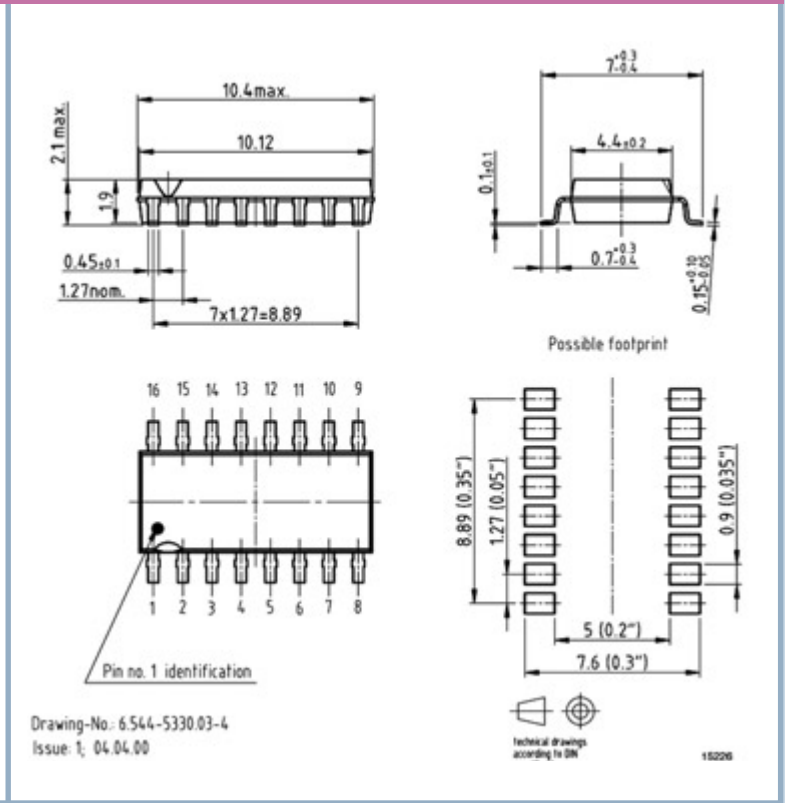
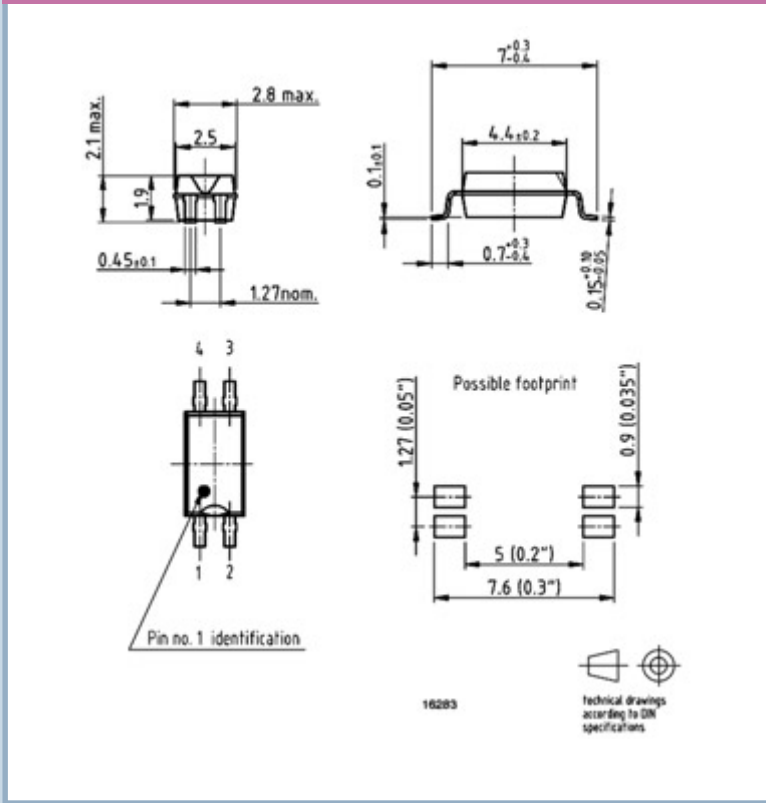

Description	Description	Description	Description
The 4pin transistor output series of optically coupled isolators consists of an infrared light emitting diode and a NPN silicon phototransistor in a super space efficient half pitch leadframe plastic package.	The 4pin AC input series of optically coupled isolators consists of 2 infrared light emitting diodes connected in inverse parallel and a NPN silicon phototransistors in a super space efficient half pitch leadframe plastic package.	The 16pin transistor output series of optically coupled isolators consists of four infrared light emitting diodes and four NPN silicon phototransistors in a super space efficient half pitch leadframe plastic package.	The 16pin AC input series of optically coupled isolators consists of eight infrared light emitting diodes connected in inverse parallel and 8 NPN silicon phototransistors in a super space efficient half pitch leadframe plastic package.

Features	Features	Features	Features
<ul style="list-style-type: none"> Marked as THP1 Current Transfer Ratio min 50% All electrical characteristics 100% tested 	<ul style="list-style-type: none"> Marked as AHP1 Current Transfer Ratio min 80% All electrical characteristics 100% tested 	<ul style="list-style-type: none"> Marked as THP4 Four Independent Channels Current Transfer Ratio min 50% All electrical characteristics 100% tested 	<ul style="list-style-type: none"> Marked as AHP4 Four Independent Channels Current Transfer Ratio min 80% All electrical characteristics 100% tested

Transistor Output		AC Input		Transistor Output		AC Input	
IS281	IS3H7	IS280		IS281-4	IS3Q64	IS2801-1	IS4600
IS2801-1		IS2805		IS2801-4		IS3H2	IS280-4
IS3H2		IS1600		IS3Q62		IS1100	IS2805-4
IS1100		IS2805		IS4100		IS281	
IS281		IS3H4					

Optically Coupled MOSFET Solid State Relays

4 Pin

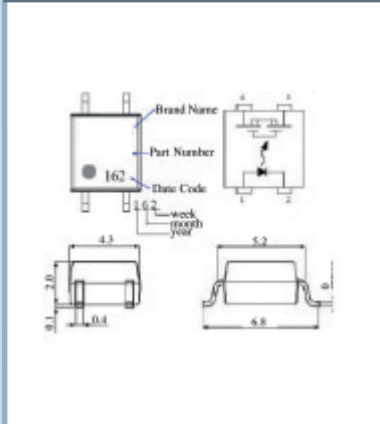

6 Pin

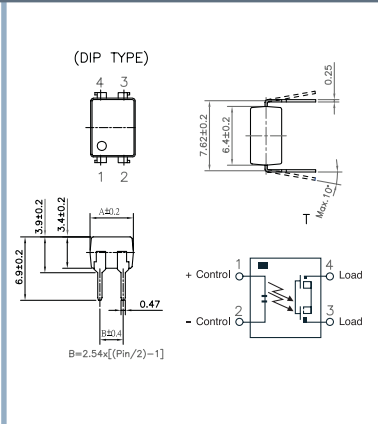

8 Pin

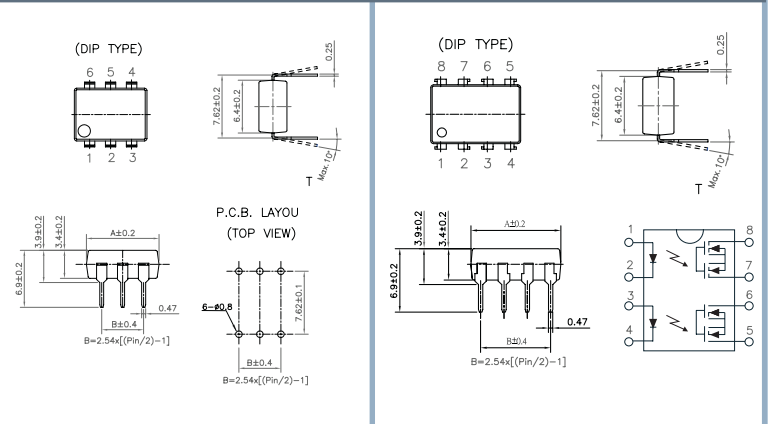

Part Numbers

IS210 IS211 IS214 IS215 IS216 IS216D	ISPA06 ISPA20 ISPA40 ISPA60 ISPB20 ISPB35 ISPB40	ISA06 ISA20 ISA40 ISA60 ISB20 ISB35 ISB40	ISDA06 ISDA20 ISDA40 ISDA60 ISDB20 ISDB35 ISDB40
---	--	---	--

Description

Isocom introduces a range of industry standard compatible optically coupled relays. The relays utilise MOSFET technology coupled to highly efficient AlGaAs infrared Light Emitting Diodes. This range is available in 4, 6 and 8 pin dual configuration. The range is available with high voltage or high current capabilities with low on-state resistances. Due to the Solid State construction there are no moving parts which dramatically increase reliability. All versions are available with wide lead spread (10.16mm) and in surface mount supplied in tape and reel if required. We supply equivalent devices for the following manufacturers: Aromat (NAIS), Clare, Toshiba, Cosmo, NEC.

Features

Series	Max Load Current	Max Load Voltage	Max On-State Resistance
A06	400mA	60V	1.4 Ohms
A20	200mA	200V	10 Ohms
A40	130mA	400V	30 Ohms
A60	70mA	600V	60 Ohms
B20	100mA	200V	30 Ohms
B35	100mA	350V	45 Ohms
B40	100mA	400V	50 Ohms
IS210	100mA	400V	30 Ohms
IS211	120mA	350V	24 Ohms
IS214	120mA	80V	12 Ohms
IS215	400mA	60V	2 Ohms
IS216	1.7A	20V	1.2 Ohms
IS216D	5A	20V	0.5 Ohms

Applications

Telecommunications
Industrial System Controllers
Measuring Instruments
Signal Transmission between Systems of different potentials and impedances

Optocoupler Product Drop-In Replacements

Isocom manufactures identical equivalents to these and more competitive parts and part numbers. Plus special screens, lead forms and tape and reel. All our products are guaranteed to meet customer-specified electrical characteristics. Yield limits may apply.

Standard Lead times 1 – 2 weeks on all parts. Includes SM, surface mount, T/R, Tape Reel, G form 10.6mm. UL, VDE, NEMCO, UL Canada Certified RoHs Lead Free Compliant.

VISHAY (INFINEON) (SIEMENS)		FAIRCHILD (MOTOROLA) (QTC, GE, GI)			NEC	TI	TOSHIBA	SHARP
IL1	SFH615A-1	MOC3009	MOC8050	H11L1	PS2501-1	TIL111	TLP121	PC354
IL2	SFH615A-2	MOC3010	MOC8080	H11L2	PS2501-2	TIL113	TLP126	PC355
IL5	SFH615A-3	MOC3011	MOC8100	H11L3	PS2501-4	TIL114	TLP127	PC357
IL74	SFH615A-4	MOC3012	MOC8101	H11L4	PS2502-1	TIL116	TLP181	PC452
ILD1	SFH617A-1	MOC3020	MOC8102	H11AA1	PS2502-2	TIL117	TLP321	PC844 (IS844)
ILD2	SFH617A-2	MOC3021	MOC8103	H11AA2	PS2505-1	TIL119	TLP321-2	PC824 (IS824)
ILD5	SFH617A-3	MOC3022	MOC8104	H11AA3	PS2505-2	TIL128	TLP321-4	PC829 (IS829)
IID74	SFH617A-4	MOC3023	MOC8106	H11AA4	PS2505-4	TIL191	TLP521	PC849 (IS849)
ILQ1	SFH618A-2	MOC3030	MOC8107	MCT2	PS2701-1	TIL192	TLP521-2	PC827 (IS827)
ILQ2	SFH618A-3	MOC3031	MOC8108	MCT2E	PS2702-1	TIL192A	TLP521-4	PC847 (IS847)
ILQ5	SFH620-1	MOC3032	MOC8112	MCT6	PS2705-1	TIL192B	TLP620	PC817 (ISP817)
ILQ74	SFH620-2	MOC3033	CNX72A	MCT61	PS2732-1	TIL193	TLP620-	PC123 (ISP817X)
MCA230	SFH620-3	MOC3040	CNX82A	MCT62	PS2801	TIL193A	TLP620-4	PC900 (IS900)
MCA255	SFH628A-3	MOC3042	H11AV1	MCT210	PS2801-4	TIL193B	TLP621	PC3H2
SFH600-1	SFH628A-4	MOC3043	H11AV2	MCT270	PS2805	TIL194	TLP621-2	PC3Q62
SFH600-2	TCMT1100	MOC3051	H11AV3	MCT271	PS2805-4	TIL194A	TLP621-4	PC3H4
SFH600-3	TCMT1103	MOC3052	H11D1	MCT272		TIL194B	TLP624	PC3Q64
SFH600-4	TCMT4100	MOC3060	H11D2	MCT273		TIL197	TLP624-2	S11MD4N
SFH601-1	TCMT1600	MOC3061	H11D3	MCT274		TIL197A	TLP624-4	S21MD4N
SFH601-2	TCMT4600	MOC3062	H11D4	MCT275		TIL197B	TLP280	
SFH601-3	IL300	MOC3063	H11G1	MCT276		TIL195	TLP281	
SFH601-4		MOC5007	H11G3	MCT277		TIL196	TLP281GB	
SFH601-5		MOC5008	MOC3080	MCT2200		TIL197	TLP281-4	
SFH609-2		MOC5009	MOC3081	MCT2201		TIL198	TLP280-4	
SFH609-3		MOC8021	MOC3082	HMHA2801		TIL199		
		MOC8030	MOC3083			TIL918		

Isocom also manufactures the following industry standards

4N25 4N26 4N27 4N28 4N35 4N37 4N38 4N39 4N29 4N30 4N31 4N32 4N33 6N135 6N136 6N137 6N138 6N139 CNY17-1 CNY17-2 CNY17-3 CNY17-4 CNY17-5 CNY17F-1 CNY17F-2 CNY17F-3 CNY17F-4 CNY17F-5 H11A1 H11A2 H11A3 H11A4 H11A5 H11C1 H11C2 H11C3 H11C4 H11C5 H11C6 HCLP2530 HCPL2531 HCPL2601 HCPL2731

> Too many more to list. Call us for specific part numbers

The innovative ISOCOM solutions below are made to match your unique design requirements.

CNY75A CNY75B CNY75C CQY80 H11J1 H11J2 H11J3 H11J4 H11J5 IS1 IS121 IS181 IS201 IS202 IS203 IS204 IS205 IS206 IS2701 IS3052 IS357 IS4N45 IS4N46 IS5 IS6003 IS6005 IS6010 IS6015 IS6030 IS604 IS605 IS608 IS609 IS611 IS620 IS621 IS622 IS7000 IS725 IS74 IS829 IS849 ISD1 ISD201 ISD202 ISD203 ISD204 ISD204-1 ISD5 ISD74 ISP321-1 ISP321-2 ISP321-4 ISP521-1 ISP521-2 ISP521-4 ISP620-1 ISP620-2 ISP620-4 ISP621-1 ISP621-2 ISP621-4 ISP624-1 ISP624-2 ISP624-4 ISP814 ISP814-1 ISP815 ISP815-1 ISP815-2 ISP815-3 ISP817 ISP817-1 ISP817-2 ISP817-3 ISP824 ISP825 ISP825-1 ISP825-2 ISP825-3 ISP827 ISP827-1 ISP844 ISP845 ISP847 ISQ1 ISQ201 ISQ202 ISQ203 ISQ204 ISQ5 ISQ74 MCA2230 MCA2231 MCA2255 > and many more.

Isocom Mini Flat Pack Range

Isocom is able to offer drop in replacements for Mini Flat Packs as detailed below.

Description

A range of optically coupled isolators consisting of infrared light emitting diodes and NPN silicon photo transistor or photo Darlington in a space efficient dual in line plastic package.

Please refer to our individual data sheets for the detailed specifications and features on our website www.isocom.com

Mini Flat Pack Related Cross Reference List

Isocom Part No	Competitor	Competitor Part No
IS121, IS121A, IS121B, IS121C, IS121D	Toshiba	TLP121
IS121A		TLP121Y
IS121B		TLP121G
IS121C, IS121D		TLP121B
IS121B, IS121C, IS121D		TLP121GB
IS181, IS181A, IS181B, IS181C, IS181D		TLP181
IS181A		TLP181Y
IS181B		TLP181G
IS181C, IS181D		TLP181B
IS181B, IS181C, IS181D		TLP181GB
IS126		TLP126
IS127		TLP127
IS357, IS357A, IS357B, IS357C, IS357D	Sharp	PC357NT
IS357A		PC357N1T
IS357B		PC357N2T
IS357C		PC357N3T
IS357D		PC357N4T
IS357A, IS357B		PC357N5T
IS357B, IS357C		PC357N6T
IS357C, IS357D		PC357N7T
IS357A, IS357B, IS357C		PC357N8T
IS357B, IS357C, IS357D		PC357N9T
IS357A, IS357B, IS357C, IS357D		PC357N0T
IS354		PC354
IS355		PC355
IS452		PC452
IS2701-1, IS2701-1A, IS2701-1B, IS2701-1C, IS2701-1	NEC	PS2701-1
IS2701-1A		PS2701-1M
IS2701-1B		PS2701-1L
IS2701-1B		PS2701-1P
IS2705-1		PS2705-1
IS2702-1		PS2702-1
IS2732-1		PS2732-1

These parts are marked as follows

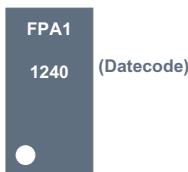
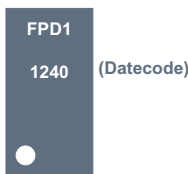
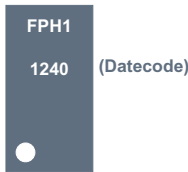
ISOCOM Part No	Description	Marked
IS121	Transistor	
IS181		
IS2701-1		
IS357		
IS354	AC Input	
IS2705-1		
IS126		
IS355	Darlington	
IS2702-1		
IS2732-1	HV Darlington	
IS452		
IS127		

Applications

- Computer terminals
- Industrial systems controllers
- Measuring instruments
- Signal transmission between systems of different potentials and impedances

MOSFET Relay Products Drop in Replacements

ISOCOM now manufactures a range of Optically Coupled that are equivalent or compatible with the following devices.

AROMAT (MATSUSHITA)		COSMO		TOSHIBA		NEC	CLARE	
AQY212S	AQV214E	KAQY212S	KAQV214E	TLP172A	TLP225A	PS7113-1A, 2A	CPC1008N	LAA126
AQY210S	AQV214H	KAQY210S	KAQV214H	TLP172G	TLP227A	PS7122A-1A, 2A	CPC1016N	LAA127
AQY214S	AQV216	KAQY214S	KAQV216	TLP174G	TLP227A-2	PS7141-1A	CPC1017N	LAA120
AQY212EH	AQV224N	KAQY212EH	KAQV224N	TLP174GA	TLP227G	PS7141-2A	CPC1018N	LAA125
AQY210EH	AQV254	KAQY210EH	KAQV254	TLP176A	TLP227G(N)	PS7141E-1A	CPC1025N	LCB110
AQY214EH	AQV254H	KAQY214EH	KAQV254H	TLP176D	TLP227G-2	PS7142-1A	CPC1030N	LCB111
AQY216EH	AQV410EH	KAQY216EH		TLP176G	TLP227G-2(N)	PS7142-2A	CPC1035N	LCB120
AQV212	AQV412EH	KAQV212		TLP176GA	TLP227GA	PS7160-1A	CPC1225N	LCB126
AQV210EH	AQV414	KAQV210EH		TLP192A	TLP227GA-2	PS7160-2A	CPC1230N	LCB127
AQV214EH	AQV414E	KAQV214EH		TLP192G	TLP592A	PS7200A-1A	CPC1510	LBB110
AQY222R1S	AQW414	KAQY222R1S		TLP197A	TLP592G	PS7200E-1A	LCA100	LBB120
AQY224NS	AQW414EH	KAQY224NS		TLP197D	TLP594G	PS7200H-1A	LCA100L	LBB126
AQV255	AQY410EH	KAQV255		TLP197G	TLP597A	PS7200K-1A	LCA110	LBB127
AQV255	AQY412EH	KAQV255		TLP197GA	TLP597G	PS7200R-1A	LCA120	
AQV227N	AQY414EH	KAQV227N		TLP200D	TLP597GA	PS7200U-1A	LCA125	
AQV217		KAQV217		TLP202A	TLP598A	PS7206-1A	LCA126	
AQV257		KAQV257		TLP202G	TLP598AA	PS7214-1A	LCA127	
AQV253		KAQV253		TLP206A	TLP598G	PS7221A-2A	LCA129	
AQV253H		KAQV253H		TLP206G	TLP598GA	PS7241-1A	PLA110	
AQV203		KAQV203		TLP206GA	TLP599A	PS7241-2A	CPC1002N	
AQV103		KAQV103		TLP222A	TLP599G	PS7241E-1A	CPC1004N	
AQV210		KAQV210		TLP222A-2	TLP797GA	PS7341-1A	PAA110	
AQV210E		KAQV210E		TLP222G	TLP797J	PS7342-1A	PAA140	
AQV104		KAQV104		TLP222G-2	TLP798G	PS7360-1A	PAA150	
AQV204		KAQV204		TLP224G	TLP798GA	PS7431-1A	LAA100	
AQV214		KAQV214		TLP224G-2			LAA110	

Isocom will advise the closest device upon request and specify the differences in specifications if any.
If you do not see the parts you are looking for, please ask!





ISOCOM
— — — — —
COMPONENTS





Sample Request Form

Request Date:	
Distributor/Representative Name:	
End Customer Name & Address:	
End Customer Tel/Email:	
Part Number:	
Quantity:	
Special CTR needed?	
Lead Forming (Standard/G/SM):	
Annual Usage:	
Application:	
Project:	
Production Start Date:	
Competition:	

For internal use only

Log No/Issue Date:	
Sent Date:	
Follow Up:	
Comments:	

Please photocopy this page and fax to +44 (0) 1429 863581 or email to sales@isocom.co.uk