

SPECIFICATIONS

Current Rating: 3A AC,DC
 Voltage Rating: 250V AC,DC
 Temperature Range: -25°C ~ +85°C
 Contact Resistance: 10mΩ Max
 Insulation Resistance: 1000MΩ Min
 Withstanding Voltage: 800V AC/minute
 Material: Nylon 66,UL94V-2

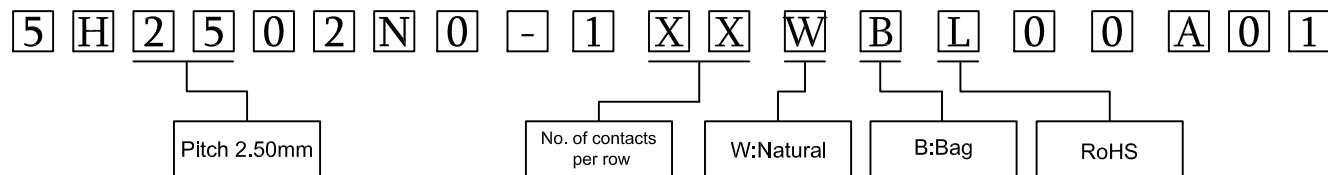

ORDER INFORMATION

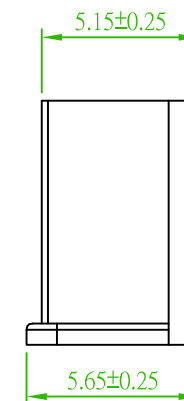
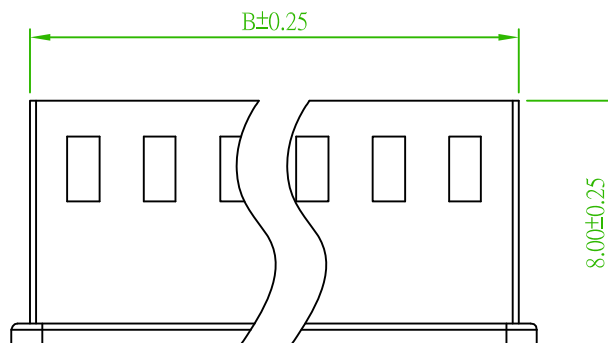
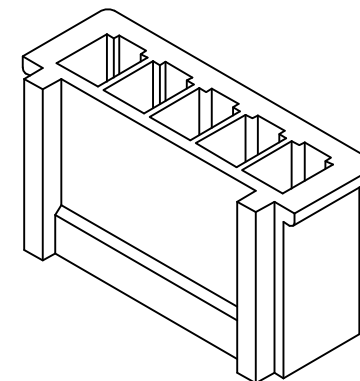
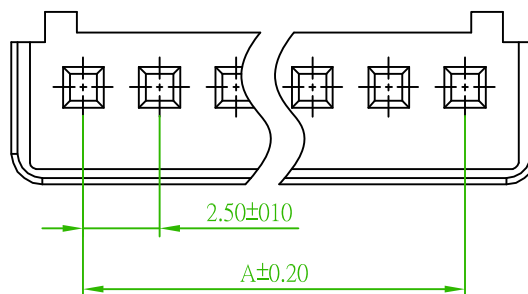

No. of contacts	Dimensions	
	A	B
02	2.50	6.00
03	5.00	8.50
04	7.50	11.00
05	10.00	13.50
06	12.50	16.00
07	15.00	18.50
08	17.50	21.00
09	20.00	23.50
10	22.50	26.00
11	25.00	28.50
12	27.50	31.00
13	30.00	33.50
14	32.50	36.00
15	35.00	38.50
16	37.50	41.00
17	40.00	43.50
18	42.50	46.00
19	45.00	48.50
20	47.50	51.00



REV.	ECN NO. OR DESCRIPTION	REVISED	DATE

 糧德精密有限公司 Amtek Technology Co., Ltd. TEL: 886-2-2260-6878 FAX: 886-2-2260-8030	品名 TITLE	2.5mm HOUSING			頁數 Page	1/1
	品號 PART NO.	5H2502N0-1XXWBL00A01			繪圖 DRAWN	Nick
	圖號 DRAWING NO.	GW090-NI011	版本 REV.	A	核對 CHECKED	Josh
	客戶品號 CUSTOMER P/N		比例 SCALE	None	承認 APPROVED	James
	公差 TOLERANCE	.X ± 0.25	單位 UNIT	mm	THIRD ANGLE PROJECTION	
		.XX ± 0.20				

SPECIFICATIONS

Current Rating: 3A AC,DC
 Voltage Rating: 250V AC,DC
 Contact Resistance: 20mΩ Max
 Insulation Resistance: 1000MΩ Min
 Dielectric Voltage: 800V AC for one minute
 Operation Temperature: -25°C to +85°C

MATERIAL

Material: Noryl, UL94V-1 

ORDER INFORMATION

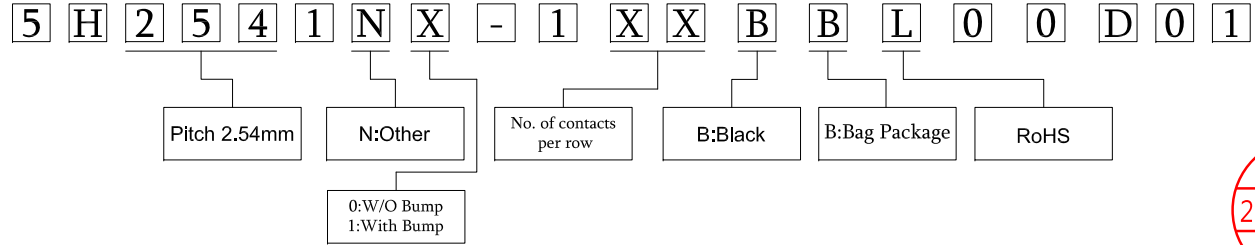

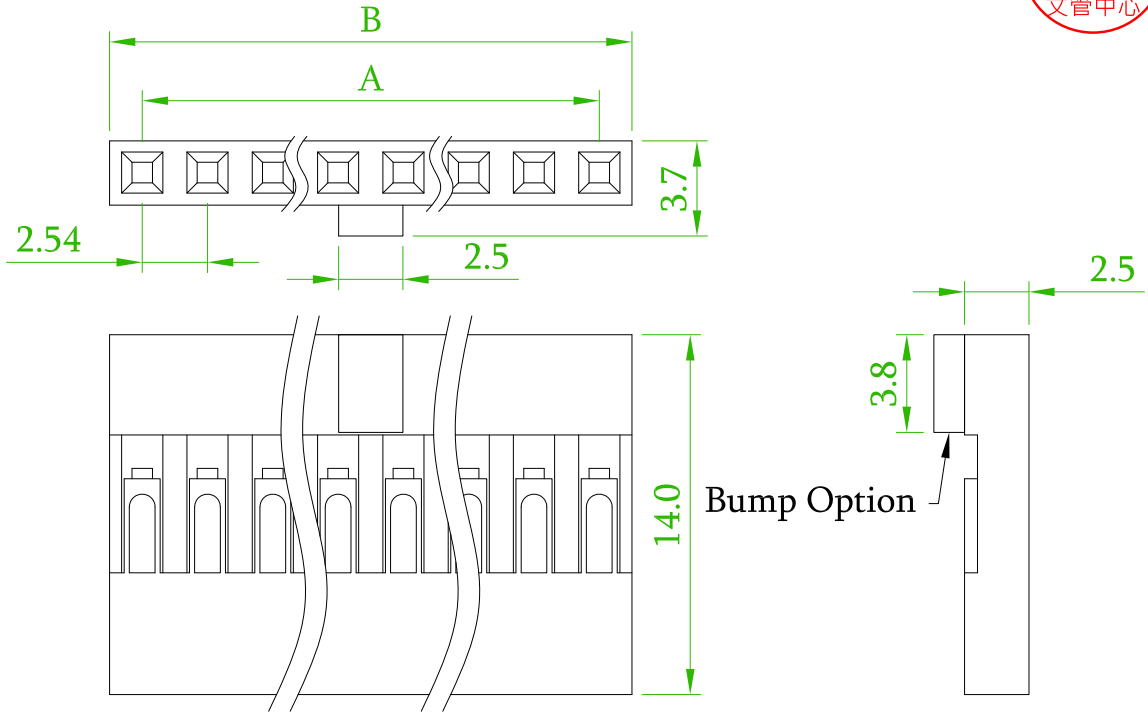

CIRCUITS	DIM. A	DIM. B
1		2.65
2	2.54	5.28
3	5.08	7.82
4	7.62	10.36
5	10.16	12.90
6	12.70	15.44
7	15.24	17.98
8	17.78	20.52
9	20.32	23.06
10	22.86	25.60
11	25.40	28.14
12	27.94	30.68
13	30.48	33.22
14	33.02	35.76
15	35.56	38.30
16	38.10	40.84
17	40.64	43.38
18	43.18	45.92
19	45.72	48.46
20	48.26	51.00
21	50.80	53.54
22	53.34	56.08
23	55.88	58.62
24	58.42	61.16
25	60.96	63.70
26	63.50	66.24
27	66.04	68.78
28	68.58	71.32
29	71.12	73.86
30	73.66	76.40
31	76.20	78.94
32	78.74	81.48
33	81.28	84.02
34	83.82	86.56
35	86.36	89.10
36	88.90	91.64
37	91.44	94.18
38	93.98	96.72
39	96.52	99.26
40	99.06	101.80



Old Part No.:2541H-1XXBX-L

	ECN NO.: 171120, revise the material: Noryl V-1, UL94V-0 -> Noryl, UL94V-1.	Gary	2017/11/23
REV.	ECN NO. OR DESCRIPTION	REVISED	DATE

 耀德精密有限公司 Amtek Technology Co., Ltd. TEL: 886-2-2260-6878 FAX: 886-2-2260-8030	品名 TITLE	2.54mm HOUSING			頁數 Page	1/1
	品號 PART NO.	5H2541NX-1XXBBL00D01			繪圖 DRAWN	Roy
	圖號 DRAWING NO.	GW097-GA795	版本 REV.	B	核對 CHECKED	Yvonne
	客戶品號 CUSTOMER P/N		比例 SCALE	None	承認 APPROVED	John
	公差 TOLERANCE	.X ± 0.35	單位 UNIT	mm	THIRD ANGLE PROJECTION	
		.XX ± 0.25				