

ORDER INFORMATION

SPECIFICATION

Current Rating: 1 AMP
 Insulation Resistance: 1000MΩ Min.
 Contact Resistance: 20m Ω Max.
 Dielectric Voltage: 500V AC for one minute
 Operation Temperature: -40°C to +105°C

MATERIAL

Insulator: Hi-Temp. Thermoplastic, UL94V-0, Black
 Contact Pin: Copper Alloy

5 P S 3 M S A 4 4 - 2 X X X X X X N X U - 0 0

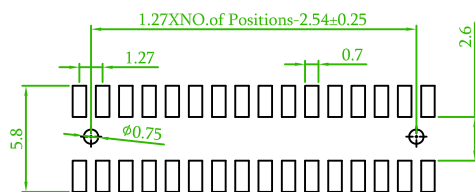
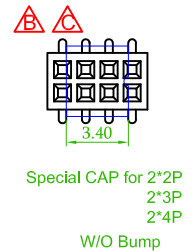
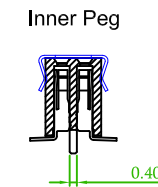
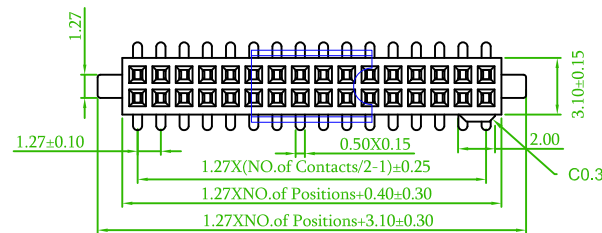
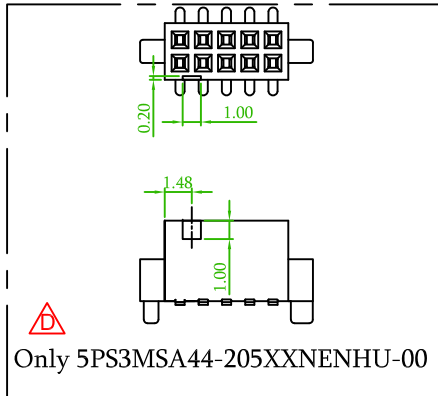
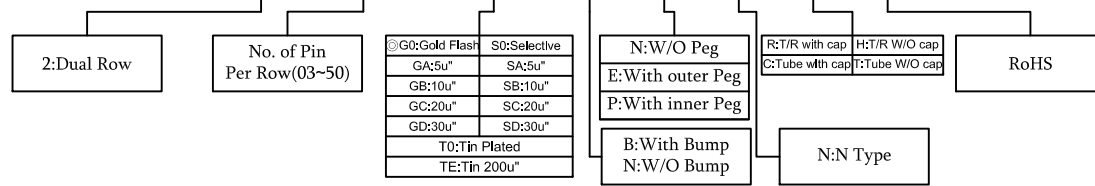

Inner Peg

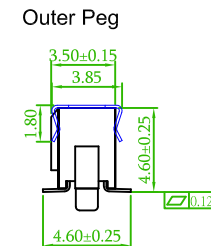
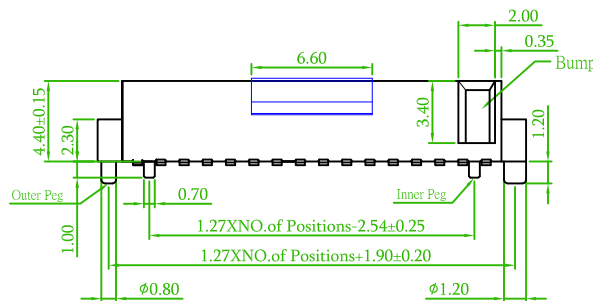

Outer Peg

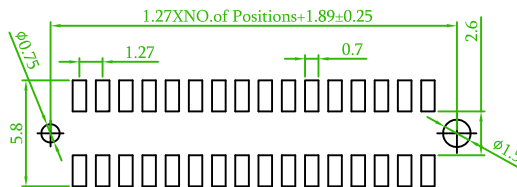
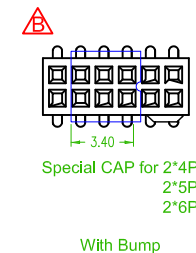

Outer Peg

Recommended PCB Layout
 (PCB TOLERANCE ±0.1)

Old Part No. : PS3M44-2XX-U

△x1	ECN NO.:171226,Add the Drawing:5PS3MSA44-205G0NENHU-00	Mia	2018/02/13
△x1	Revise the Cap size:3.00->3.40	Roy	2016/12/13
△x2	Add the drawing	Mia	2016/05/20
REV.	ECN NO. OR DESCRIPTION	REVISED	DATE

糧德精密有限公司
 Amtek Technology Co., Ltd.
 TEL: 886-2-2260-6878
 FAX: 886-2-2260-8030

品名 TITLE	FEMALE HEADER 1.27mm D/R V/T SMT TYPE				頁數 Page	1/1
品號 PART NO.	5PS3MSA44-2XXXXXXNXU-00				繪圖 DRAWN	Roy 2015/08/31
圖號 DRAWING NO.	GN003-RL223		版本 REV.	D	核對 CHECKED	John 2015/08/31
客戶品號 CUSTOMER P/N			比例 SCALE	None	承認 APPROVED	John 2015/08/31
公差 TOLERANCE	.X ±0.20	.XX ±0.12	.X°±3	單位 UNIT	mm	THIRD ANGLE PROJECTION