

ELECTRICAL 
 Standard: UL
 Rated Voltage: 300V
 Rated Current: 10A
 Contact Resistance: 20mΩ
 Insulation Resistance: 500MΩ/DC500V
 Withstanding Voltage: AC 2000V for one min
 Wire range: 22-16AWG 1mm²

ORDER INFORMATION

5 T B 6 3 5 S - 1 6 S N X X B L B - W 1

Series No. No of Pins total (02-26P) B:Black B:Bag



MECHANICAL
 Torque: 0.5N.m
 Temp. Range : -40°C ~ +105°C
 Max Soldering: +250°C, for 5 Sec



MATERIAL
 Housing : PA66, UL94V-0
 Screws: M3, Steel, Ni Plated
 Pin Header : Copper Alloy 0.8t, Tin Plated

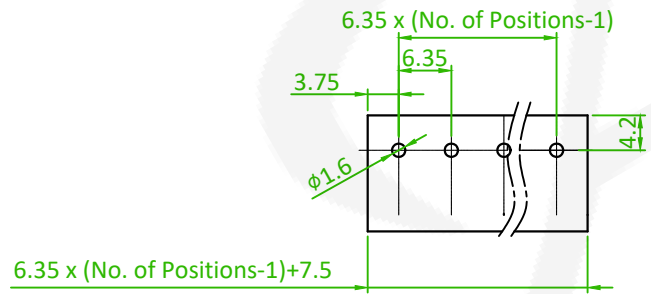
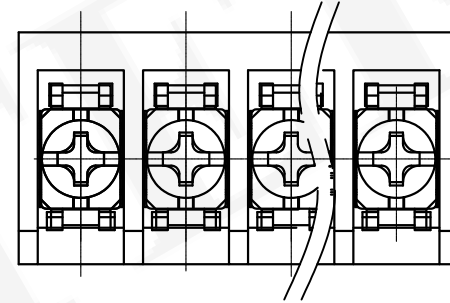

AMTEK 糧德
 2021.01.13
 Released DCC

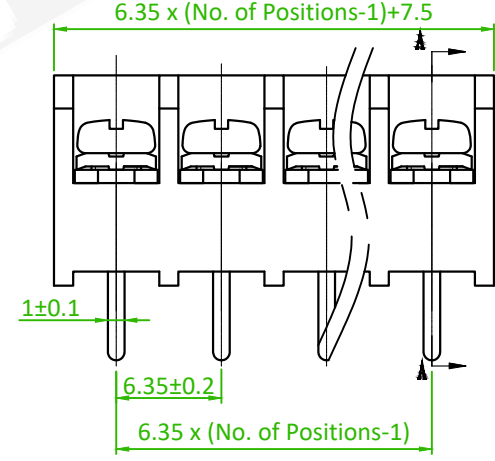

P.C.B. LAYOUT



linear dimension (Tolerances Standard GB/T 14486-2008)								—		
variable range	to 6	over 6 to 10	over 10 to 30	over 30 to 60	over 60 to 100	over 100 to 160	over 160 to 10	over 10 to 100	over 100 to 100	
tolerance	±0.20	±0.30	±0.50	±0.70	±1.00	±1.30	±1.60	0.10	0.30	0.60

 x2	ECN NO:201211 Revise the PART NO	Alice	2021/01/04
 x1	ECN NO:200718 Revise the Tolerance	Alice	2020/11/11
 x1	ECN 200102: Remove the IEC	David	2020/06/06
REV.	ECN NO. OR DESCRIPTION	REVISED	DATE



糧德精密有限公司
 Amtek Technology Co., Ltd.
 TEL: 886-2-2260-6878
 FAX: 886-2-2260-8030

品名 TITLE	6.35mm Terminal Block				頁數 Page	1/1
品號 PART NO.	 5TB635S-16SNXXBLB-W1			繪圖 DRAWN	Mia 2018/04/12	
圖號 DRAWING NO.	GN011-MD072	版本 REV.	D	核對 CHECKED	Josh 2018/04/12	
客戶品號 CUSTOMER P/N		比例 SCALE	None	承認 APPROVED	Jason 2018/04/12	
公差 TOLERANCE		單位 UNIT	mm	THIRD ANGLE PROJECTION	