

### SPECIFICATIONS

Current Rating: 3A AC,DC  
 Voltage Rating: 250V AC,DC  
 Temperature Range: -25°C to +85°C  
 Contact Resistance: 10mΩ Max  
 Insulation Resistance: 1000MΩ Min  
 Dielectric Voltage: 1000V AC for one minute

### MATERIAL

Contact Pin: Brass  
 Insulator: LCP, UL94V-0 

### ORDER INFORMATION

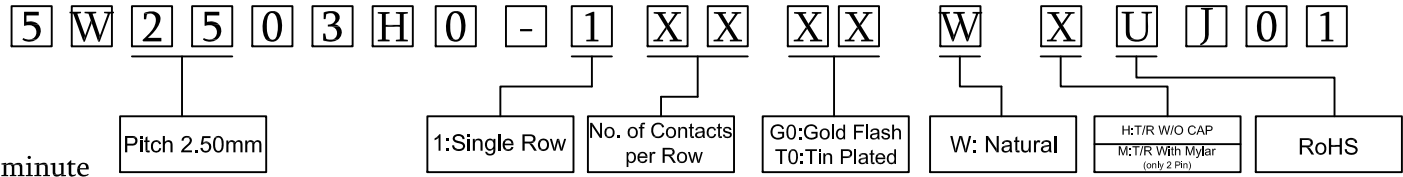

No. of Contacts	Dimensions(mm)		
	A	B	C
02	2.50	10.00	5.90
03	5.00	12.50	8.40
04	7.50	15.00	10.90
05	10.00	17.50	13.40
06	12.50	20.00	15.90
07	15.00	22.50	18.40
08	17.50	25.00	20.90
09	20.00	27.50	23.40

No. of Contacts	Dimensions(mm)		
	A	B	C
10	22.50	30.00	25.90
11	25.00	32.50	28.40
12	27.50	35.00	30.90
13	30.00	37.50	33.40
14	32.50	40.00	35.90
15	35.00	42.50	38.40
16	37.50	45.00	40.90

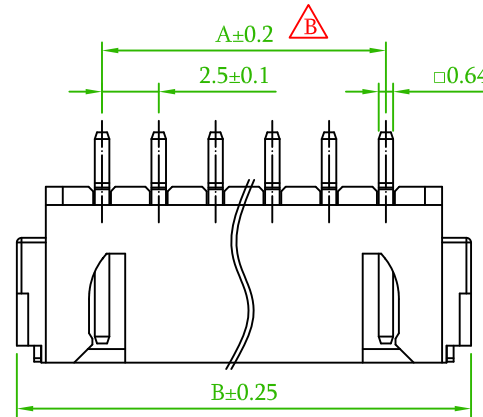

3P~16P Shape  
SCALE 1:1

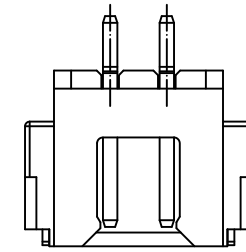

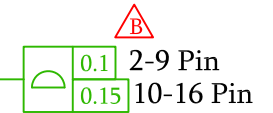
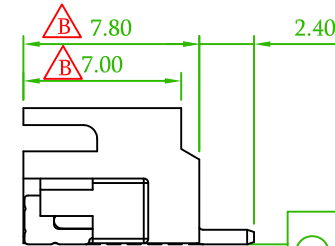
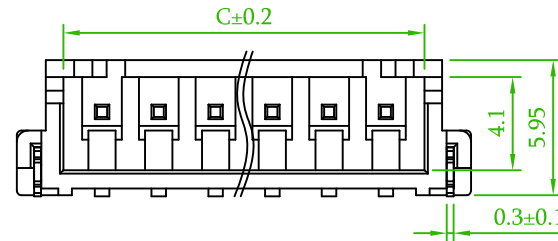
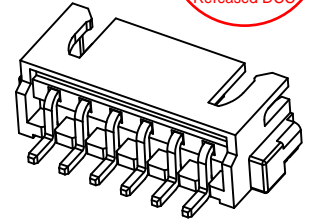

2P Shape  
SCALE 1:1

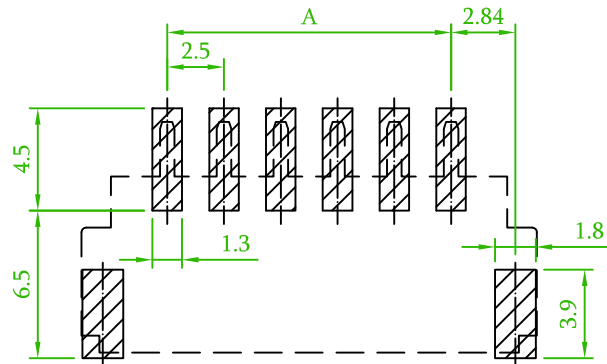

Old Part No.:2503MR-XX-U



Recommended PCB Layout  
(PCB TOLERANCE ±0.05)

REV.	ECN NO. OR DESCRIPTION	REVISED	DATE
	QEC NO.: 190503, revise the material.	Nick	2019/05/23
	QEC NO.: 190102, revise dimensions, tolerances, add the drawing of 2 Pin.	Gary	2019/01/11



糧德精密有限公司  
Amtek Technology Co., Ltd.  
TEL: 886-2-2260-6878  
FAX: 886-2-2260-8030

品名 TITLE				2.5mm WAFER R/A SMT TYPE			頁數 Page	1/1
品號 PART NO.		5W2503H0-1XXXXWXUJ01		繪圖 DRAWN	Eloise		2017/01/04	
圖號 DRAWING NO.	GW004-EL200	版本 REV.	C	核對 CHECKED	Josh		2019/01/11	
客戶品號 CUSTOMER P/N		比例 SCALE	None	承認 APPROVED	Jason		2019/01/11	
公差 TOLERANCE	.X ± 0.30 .XX ± 0.20	單位 UNIT	mm	THIRD ANGLE PROJECTION	