

SPECIFICATIONS

Current Rating: 3A AC,DC
 Voltage Rating: 250V AC,DC
 Temperature Range: -25°C to +85°C
 Contact Resistance: 10mΩ Max
 Insulation Resistance: 1000MΩ Min
 Withstanding Voltage: 800V AC/minute
 Solder Tabs: Brass/Tin-plated
 Material:Nylon 66,UL94V-0

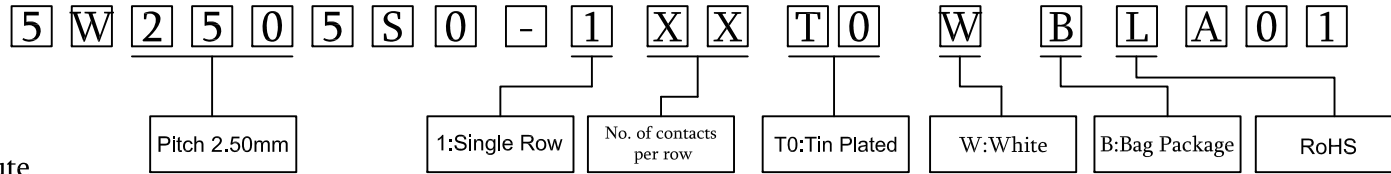

ORDER INFORMATION

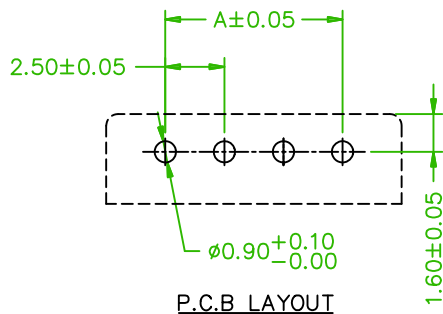
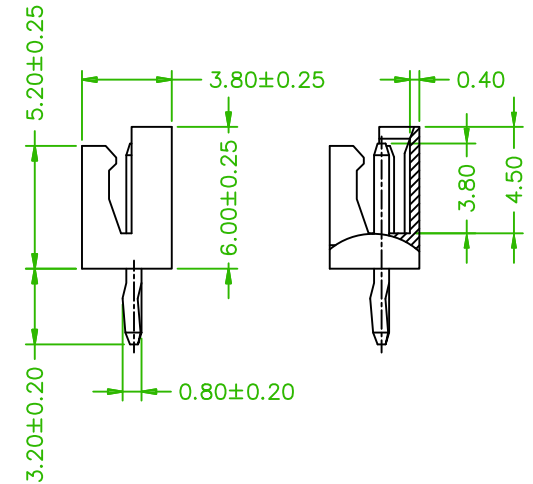
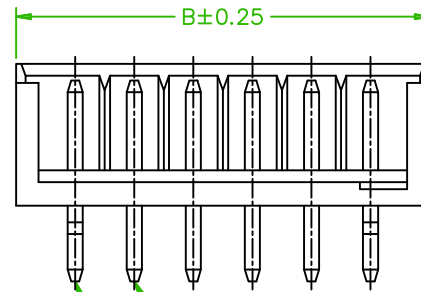
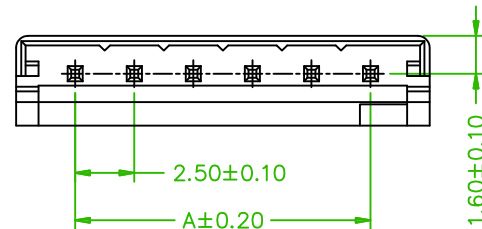

No. of contacts	Dimensions	
	A	B
02	2.50	7.50
03	5.00	10.00
04	7.50	12.50
05	10.00	15.00
06	12.50	17.50
07	15.00	20.00
08	17.50	22.50
09	20.00	25.00
10	22.50	27.50
11	25.00	30.00
12	27.50	32.50
13	30.00	35.00
14	32.50	37.50
15	35.00	40.00



Old Part No.:2505S-XXTW-L

 糧德精密有限公司 Amtek Technology Co., Ltd. TEL: 886-2-2260-6878 FAX: 886-2-2260-8030	品名 TITLE	2.5mm WAFER STRAIGHT			頁數 Page	1/1
	品號 PART NO.	5W2505S0-1XXT0WBLA01			繪圖 DRAWN	Mia 2015/09/10
	圖號 DRAWING NO.		版本 REV.	B	核對 CHECKED	John 2015/09/10
	客戶品號 CUSTOMER P/N		比例 SCALE	None	承認 APPROVED	John 2015/09/10
	公差 TOLERANCE	.X ± 0.25 .XX ± 0.15	單位 UNIT	mm	THIRD ANGLE PROJECTION	

△	Revised the Drawing	B	2016/08/26 Jeff
REV.	ECN NO. OR DESCRIPTION	REVISED	DATE