

HSEUreg07201

DIN Rail

Made in Germany

720W Programmable Power Supply current and voltage programmable

Specification:

- Metal housing
- 90% efficiency
- -25°C...+60°C full output power
- Natural convection
- Galvanic insulated
- Continuous short circuit protected
- Overload (OVP) & low voltage protected
- Soft start & auto-recovery
- Hold up time >40ms
- No base load required
- Electronic inrush current limiter 13.8Apeak
- Analogue interface 0-5Vdc/0-10Vdc/0-20mA/4-20mA
- Real time output monitoring of voltage and current
- External shutdown
- Sense control
- Series & parallel operation
- DIN Rail 35mm & wall mount
- Screw terminals AWG20...AWG6
- High reliability, shock & vibration proof
- 24 hours burn in test
- EMI/EMS EN61000-6-2,3, EN55022 class B
- IEC(EN)60950-1 in accordance to cUL60950/16950

Available outputs: 0...18V, 0...30V, 0...50V, 0...90V, 0...130V, 0...180V, 0...240V

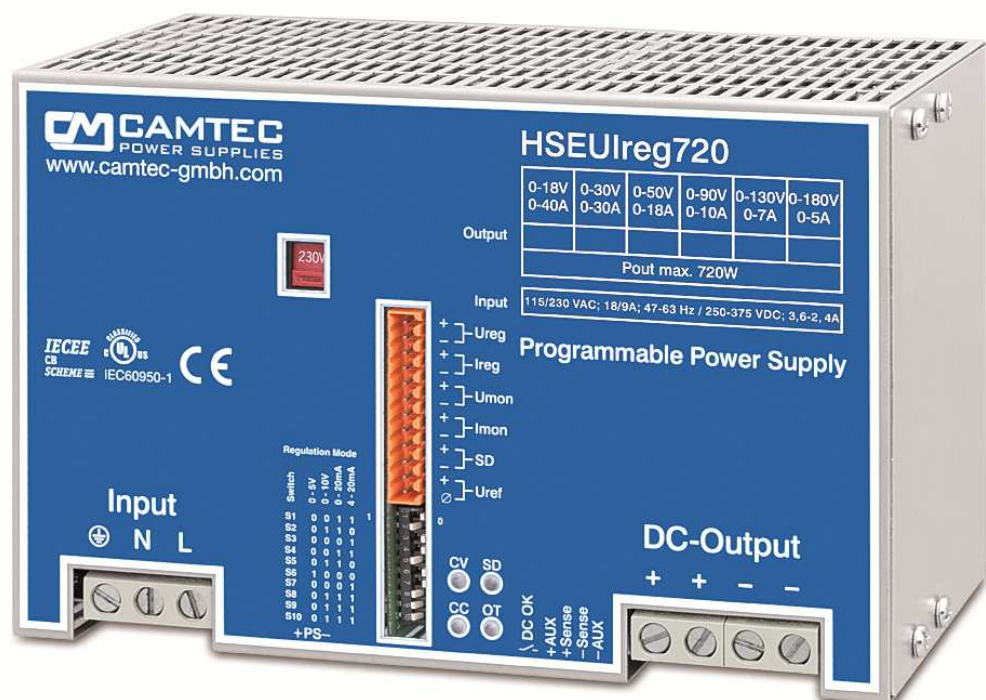

In accordance with IEC60950-1

AC Input Range	90..132Vac / 184..265Vac , 47...63Hz , 250...375Vdc						
AC Input Rating	115Vac<13,2A 230Vac<6,5A 250Vdc<3,6A 375Vdc<2,4A						
Rated DC Voltage	0...18V	0...30V	0...50V	0...90V	0...130V	0...180V	0...240V
Oversvoltage Protection	22Vdc	35Vdc	59Vdc	105Vdc	150Vdc	210Vdc	280Vdc
Max. DC Current -25°C...+60°C	0...40A	0...30A	0...18A	0...10A	0...7A	0...5A	0...3,8A
Max. DC Current +70°C	0...30A	0...22,5A	0...13,5A	0...7,5A	0...5,3A	0...3,8A	0...2,9A
Ripple Peak 230Vac 20MHz	40mVpp	40mVpp	100mVpp	150mVpp	200mVpp	300mVpp	400mVpp
Pmax	720W continuous						
Operation failure relay	Yes, break contact (fig.4), protective electrical separation ≤60Vdc						
Sense function	Compensation 2V per lead load, protective electrical separation ≤60Vdc						
Remote Shutdown	Yes, protective electrical separation ≤60Vdc						
Analogue Interface	Yes, protective electrical separation ≤60Vdc						
Digital Interface	Yes, available option (incl. Software), protective electrical separation ≤400Vdc (t.b.a.)						
Derating	+60°C...+70°C 2.5%/°C						
Accuracy	< ± 1.5% interface						
Load regulation	< ± 0.05% 0-100%						
Slew Rate	15ms rise time 0V...Umax						
Response Load Change	<1ms 10-100%, 100-10%						
Base Load	None						
Efficiency 230Vac	90% typical						
Short Circuit Protection	Continuous						
Idling-proof	Yes, continuous						
Temperature Control	Yes, thermal shutdown with auto recovery (+70°C, metering distance 10mm)						
Hold Up Time	>40ms 230Vac						
Inrush Current	<9,8Aeff < 13.8Apeak (230Vac) active inrush current limiter						
Softstart	100ms typical						
Cooling	Natural convection						
Ambient Operating Temp.	- 25°C...+70°C						
Ambient Storage Temp.	- 40°C...+85°C						
Environment	Humidity 95% non-condensing @ 25°C, climate class. 3k3, pollution rate II						
EMI	EN55022 class B						
EMS	EN61000-6-2,3						
Safety	cUL60950, EN60950-1, EN60204-1						
Safety class 1(A)	VDE0805, VDE0100						
Isolation Path	> 8mm						
Input / Output	Galvanic insulated 3000Vac						
Meantime By Failure (MTBF)	400000h (IEC61709)						
Dimensions (HxWxD)	130x200x114,5mm						
Weight	3000g						
Screw Terminals (In/Out)	AWG20...AWG6 , 0,5...16mm²						

		work.resist.Ω
Programme [V]	0...10Vdc	1 MΩ
Programme [V]	0...5Vdc	1 MΩ
Programme [A]	0...20mA	500 Ω
Programme [A]	4...20mA	500 Ω
Monitoring [V]	0...10Vdc/5mA	
Monitoring [V]	0...5Vdc/5mA	
Shutdown	Open Collect.	
Sensing	2V per lead load	
Reference [V]	10Vdc/5mA	
Reference [V]	5,2Vdc/5mA	
Power Good	Relay	"b" contact

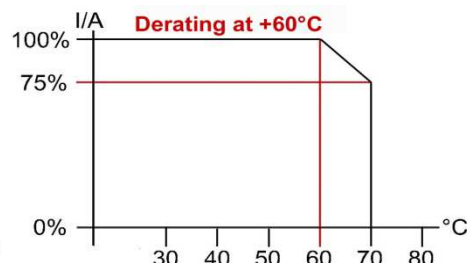
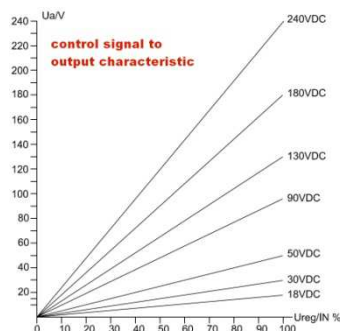

Ordering Information:

Output	Type (DIN-Rail standard)	Part Number	Built-in 5W Power Sink	Part Number	Option	Part Number
0...18V	HSEUreg07201.18T	304.1084.001CA	HSEUreg07201.18TPS	304.1084.011CA	USB 2.0 Interface UI.Drive Software XP/W7/W8	304.1098.001CA
0...30V	HSEUreg07201.30T	304.1084.002CA	HSEUreg07201.30TPS	304.1084.012CA		
0...50V	HSEUreg07201.50T	304.1084.003CA	HSEUreg07201.50TPS	304.1084.013CA	ADTW201 DC-repeater	304.1090.001CA
0...90V	HSEUreg07201.90T	304.1084.004CA	HSEUreg07201.90TPS	304.1084.014CA		
0...130V	HSEUreg07201.130T	304.1084.005CA	HSEUreg07201.130TPS	304.1084.015CA	PS200 external 200W Power Sink	304.xxxx.001CA
0...180V	HSEUreg07201.180T	304.1084.006CA	HSEUreg07201.180TPS	304.1084.016CA		
0...240V	HSEUreg07201.240T	304.1084.007CA	HSEUreg07201.240TPS	304.1084.017CA	Wall Mount Kit	220.1002.001CA

Conception

The HSEUreg power supply series realizes very high power efficiency in a space-saving housing. Latest generation electrical devices relate to the high reliability of all CAMTEC products. The CAMTEC philosophy is, to employ 125°C low ESR ultra long life capacitors where expedient to achieve a superior lifetime of our products. The HSEUreg-series is made for Measuring & Control-Units to allow an easy design of P- or PI-controllers at an attractive price value.

Thermal shutdown (p.6 fig.3)

The HSEUreg-series is featured with a thermal overload shut down and auto recovery behaviour.

Control type

The power supplies accurately works down low output voltages down to 0V. Thereby the switching frequency is absolute stabile. The output response is linear to the input signal.

Sensing feature (p.5)

The HSEUreg has a sense operation mode to compensate potential drop at the supply line. It is a standard for the 0..18Vdc, 0..30Vdc and 0..50Vdc types. For all other types it is a feature up on request.

Shutdown feature

All HSEUreg units are featured with a shut down (open collector). ON= open contact, OFF= closed contact 1Vdc max. . The shutdown connections have an internal pull-up resistor with 6800 Ω at the plus line (+15V inserted).

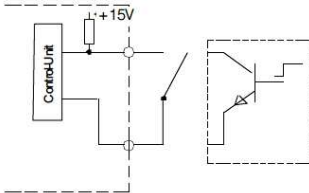

UI-characteristic:

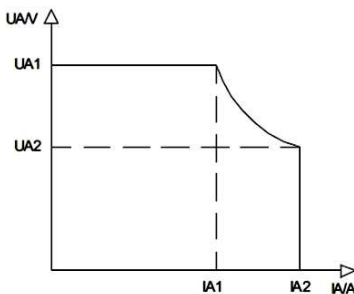

Type	UA1	IA1	UA2	IA2	Pmax
HSEUreg07201.18	18V	40.0A	18V	40.0A	720W
HSEUreg07201.30	30V	24.0A	24V	30.0A	720W
HSEUreg07201.50	50V	14.4A	40V	18.0A	720W
HSEUreg07201.90	90V	8.0A	72V	10.0A	720W
HSEUreg07201.130	130V	5.0A	103V	7.0A	720W
HSEUreg07201.180	180V	4.0A	144V	5.0A	720W
HSEUreg07201.240	240V	3.0A	190V	3.8A	720W

Programmable Outputs:

Output Voltage & output current control:

The output voltage is linear proportional to the input signal. 10% input signal will deliver 10% of the maximum output voltage, 50% input will give a ratio of 50% output and 100% will provide 100% output. The USEUreg features 0-5Vdc, 0-10Vdc, 0-20mA or 4-20mA control signal input. The setting has to be chosen from a DIP-switch at the front-side. The input impedance is 1MΩ with voltage control mode settings. The input impedance is 500Ω with current control mode settings.

Pos.	0 - 5V	0 - 10V	0 - 20mA	4 - 20mA
S01	0	0	1	1
S02	0	1	1	0
S03	0	0	0	1
S04	0	0	1	1
S05	0	1	1	0
S06	1	0	0	0
S07	0	0	0	1
S08	0	1	1	1
S09	0	1	1	1
S10	0	1	1	1

Tolerance compensation adjust:

It is not necessary to adjust the basic of the output voltage or output current level. The engineers abandoned a compensation potentiometer to prevent malfunction from wrong basic adjustments.



Warning:

Tuning the output voltage over the maximum level may cause deviations from the technical data table. If the control inputs are not connected at all this may cause a minimum voltage of 100mV at the device main outputs.



All control I/O are connected to Uref

The current operation mode features a 500R input impedance to the control inputs. Be aware that your PLC is capable to trigger recommended line power.

PIN	Description	Value
01	+ V progr. input	0-5V 0-10V
02	- V progr. input	0-20mA 4-20mA
03	+ A progr. input	0-5V 0-10V
04	- A progr. input	0-20mA 4-20mA
05	+ V progr. output	0-5V/0-10V 5mA
06	- V progr. output	0-5V/0-10V 5mA
07	+ A progr. output	
08	+ A progr. output	Open collector
09	+ SD shutdown	
10	- SD shutdown	Open collector
11	+ Uref	5.2V /10V 5mA
12	- Uref	ref return

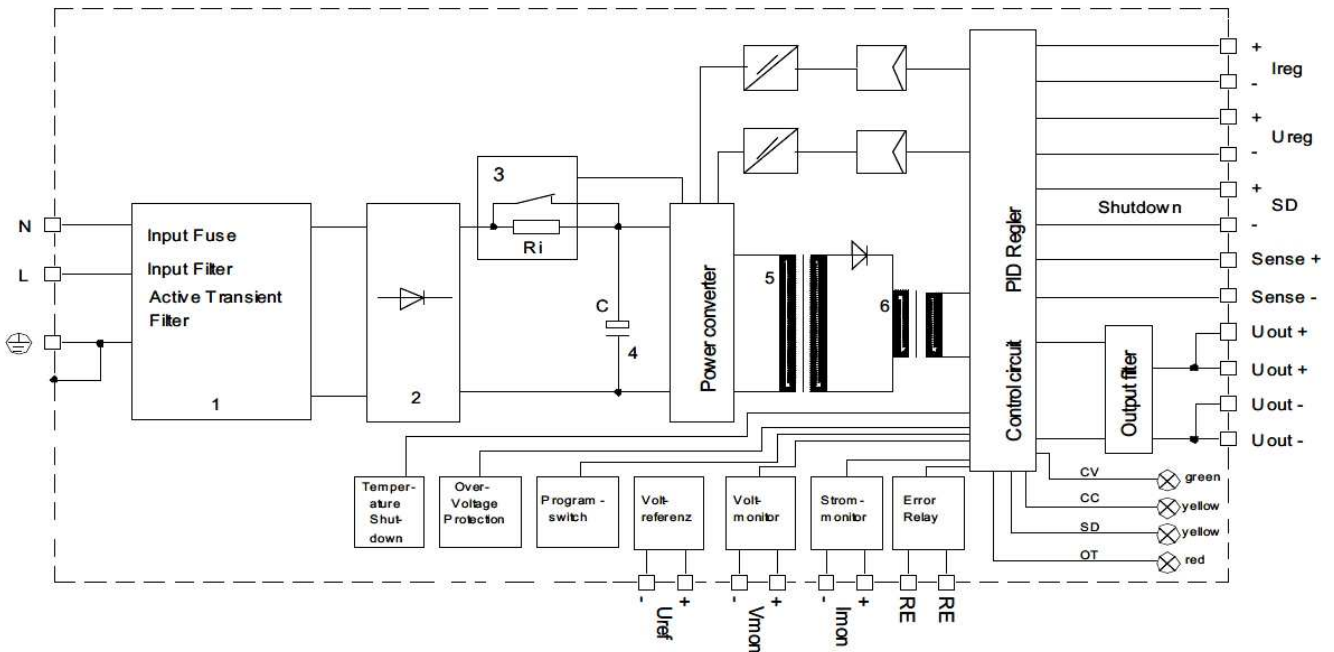

1) Active Transient Filter 2) Rectifier 3) Inrush Current Limiter 4) Load Capacitor 5) Power Transformer 6) Storage Choke

Lighting: CV = constant voltage operation CC = constant current operation SD = shutdown operation OT = temperature failure >70°C

Technical Description

The HSEUreg-Series is a programmable switch mode power supply. Engineered and manufactured in by CAMTEC in Germany, it is designed for challenging applications like railway, drives, test-stands and machine-building. The HSEUreg provides a low Ripple-Noise, good Load- Regulation and high efficiency >90% (typ. @ 230Vac). High-end long life capacitors guarantee Hold-up-Time and extended lifetime of the power supply. Our HSEUreg-design starts complex loads easily. The internal control manages illegal operating conditions to prevent your system from failures. An operation failures recording is on board via galvanic insulated relay connection (page 2 table). All HSEUreg power supplies are idling-proof and short circuit protected. Supply units of the same type and output voltage feature parallel or series operation. The HSEUreg also features active high input transients with suppressor diodes, X2-capacitors and varistors. The design rules set value on extended interference immunity and safety. The PSU is engineered in accordance to EN60950-1 and EMC-compatibility to EN55022 class B.

Indicator	230Vac
Peak inrush current	13.8A peak
Effektive inrush current (RMS)	9.8A _{eff}
Inrush duration (t _{inr})	400ms
Over all power-up time	500ms

Inrush Current Limiter Block Diagram

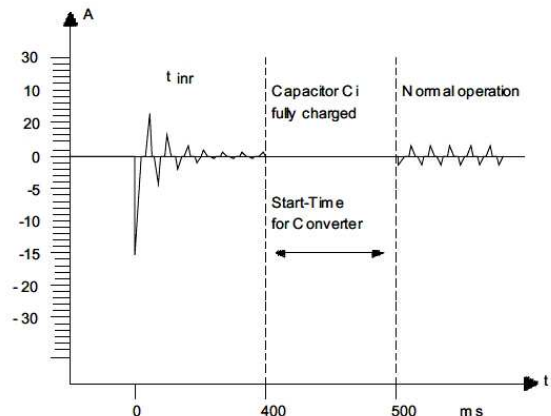
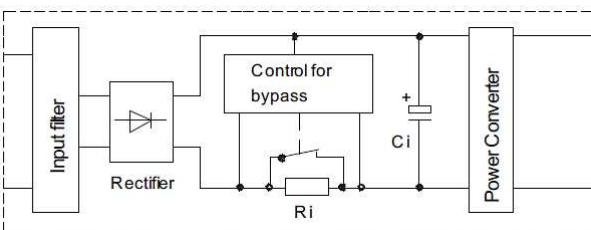

Monitor Outputs SCM (fig.1)

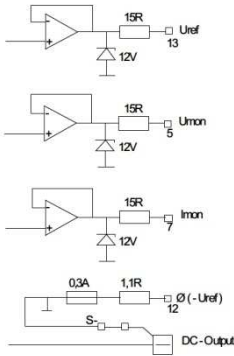

Monitor Output Connections (fig.2)

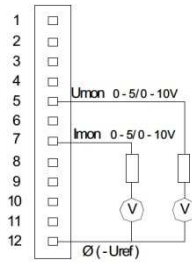

Monitor Outputs

The monitor outputs are buffered with OP-amplifiers, pre-resistors & parallel connected zener diodes (fig.1). The monitor outs can be selected between +5Vdc or +10Vdc control voltage. The signal is absolute proportional to the adjusted output voltage and current. The monitor outputs are non-floating. Connections see figure 2.

Programmable Inputs

The output voltage and the output current are programmed with an analogue signal. The input signal is selectable between 0-5Vdc, 0-10Vdc, 0-20mA or 4-20mA with a front sided DIP-switcher. The response is very exact and. The output response behaves linear to the control signal.

The inputs are protected with internal pre-resistors, zener diodes and capacitors (fig.3). The capacitor limits the slew rate, accurately. The program inputs are non-floating. The monitor GND is connected to the negative pole of the main outputs. An incorrect connection triggers an internal PTC fuse. Unlocking the incorrect connection resets this fuse to being recovered (auto recovery).

External potentiometer control mode (fig.4)

The USEUreg features an internal reference voltage of Uref = 5,2Vdc or 10,4Vdc, selected with the DIP-switch. An external pre-resistor or a potentiometer of 10k can be connected to adjust the output voltage and current.

Program Inputs SCM (fig.3)

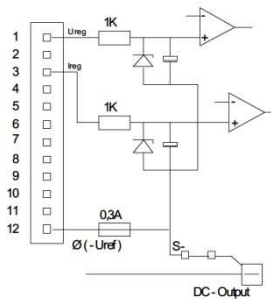

Program Input Connections (fig.4) (example with external poti)

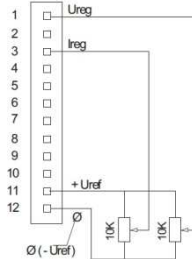

Sense Mode

The HSEUreg provides sensing connections to compensate voltage drop down from wire system. The maximum compensation is 2V (fig.9). Be aware that this operation mode may recommend extended preparations concerning interference elimination or other protections. It should be set by the advanced user.



Non-sense mode recommends the S +/- connected to AUX +/- with very short wires = Local Sensing (fig.5)

Local Sensing (fig.5)

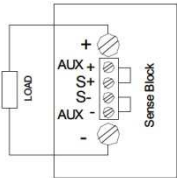

Remote Sensing (fig.6)

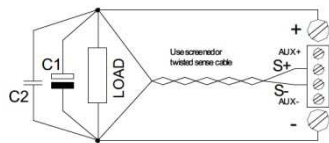

Remote Sensing (2V per lead load, fig6)

Disconnect local sensing wires (fig.1) from the AUX +/- and the S +/- connections. Connect the sense lines to the load. Be sure that +/- connections are matching!

To basically prevent from interferences enable to twist sense compensation lines. To reduce inductive influences make sure that load wires are installed closely each other. Driving a pulsative load requires a large electrolytic and a ceramic capacitor being connected (see fig.6 C1 & C2). Make sure that C1 & C2 are not oscillating with load wires. This would cause ripple voltage into the lines. The internal over voltage protection (OVP) controls the output voltage directly at the output connectors. It opens automatically in case of failure from the source (p.6 fig.4).

Battery Charger Mode (fig.7)

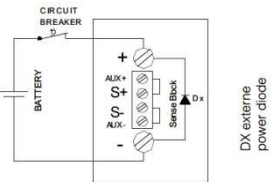

External Sense Protection (fig.8)

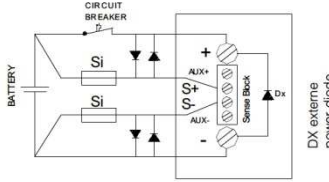

Battery Charger Mode (fig.7)

The HSEUreg is the perfect a battery charger. It can be used as constant voltage (CV) or constant current charger (CC). As a stand-alone solution the HSEUreg features constant charging with automatic over charging protection. Used with an external control unit (PLC) the HSEUreg charges any battery backup application you need to install, at very low investment cost with a perfect control and system compatibility from the PLC.

We advise to use a circuit breaker to prevent from disconnections. Use fast Z-types with the double battery dc-voltage capability, like being used for semiconductor protection.



Remote Sensing with battery charger

Using the HSEUreg as a battery charger, avoid remote sensing operation mode. It may cause serious damage to the unit when the battery connections are being mixed up. If you really need to install Remote Sensing apply to the figure 8 circuit. Good values are 250mA for Si fuses and 3...5A capability for the diodes.

Maximum Sense Compensation (fig.9)

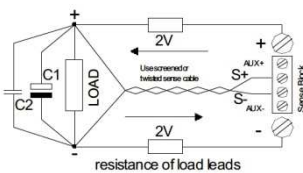

Series Connection (fig.1)

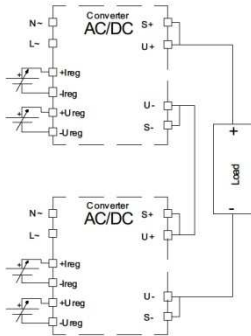

Parallel Connection (fig.2)

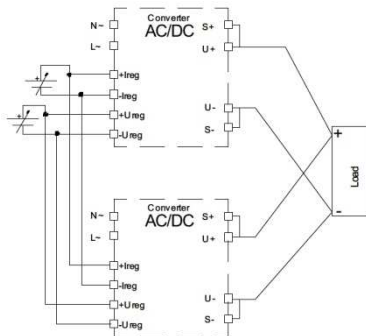

Series Connection (fig.1)

To increase output voltage equal HSEUreg can be connected in series. The control I/O should be galvanic insulated in the series mode. If not the minus main output is connected to the control I/O. Use our external option Isolating Transformer ADTW201 being validated with the HSEUreg. Be aware of safety norms if your target output voltage exceeds safety voltage.

Parallel Connection (fig.2)

To increase the output power up to 5 HSEUreg can be parallel connected. Advise using busbars to connect HSEUreg in parallel. Always use identical length and identical cross sections to the busbar.

ADTW201 Isolating Transformer (option) (fig.5)

The isolating transformer is used to galvanic isolate impressed current. The device is self powered. The input to output ratio is 1:1. For further information seek advice from page 10.

Over Voltage Protection (3a)

Vout	OVP	Iout -25°C...+60°C	Iout +70°C
0...18Vdc	22Vdc	40.0A	30.0A
0...30Vdc	35Vdc	30.0A	22.5A
0...50Vdc	59Vdc	18.0A	13.5A
0...90Vdc	105Vdc	10.0A	7.5A
0...130Vdc	150Vdc	7.0A	5.3A
0...180Vdc	210Vdc	5.0A	3.8A
0...240Vdc	280Vdc	3.8A	2.9A

Temperature Derating (fig.3)

Derating & Over Temperature (fig.3)

If the ambient temperature exceeds trigger point >70°C the HSEUreg shuts down (metering point 10mm from outside device). After being recovered from over temperature the device restarts automatically to normal operation.

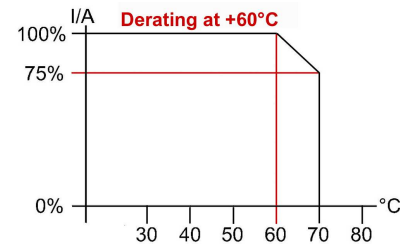

Power Good (fig.4)

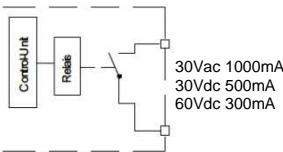

Function LED-Bar

CV	GRN	Constant voltage
CC	YEL	Constant current
SD	YEL	shutdown
OT	RED	Over temperature

ADTW201 Isolating Transformer (fig5)

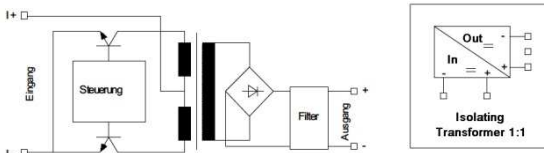

OVP Over Voltage protection (3a)

The HSEUreg features over voltage protection. Exceeding OVP results in a locked shutdown mode. Resuming the failure causes automatic restart into normal operation.

Power Good Signal (fig.4)

Galvanic insulated open with failure, closed at normal operation.



Technical Information ADTW201 external DC-Repeater	
Input (Ie)	0...20mA, 4...20mA (max. 50mA)
Voltage drop (Uw)	Uw>1.5V (Ie=20mA)
Max. apparent ohmic resistance (Ra)	500R @ Ie=20mA
Input Impedance (R)	R=Ra+Uw/Ie
Barrier Frequency (Fa)	Fa=5kHz (-3dB) with Ra=500R @ Ie=20mA
Output	1:1
Ripple / Noise	>0,5% with 20mA and Ra=500R
Linear Failure	>0,03% / 100R
Transient oscillation current	35uA
Latency	150us 0..20mA, Ra=500R, 10...90%
Isolation Voltage Input/output	500V
Operation Temperature	0...50°C
Temperature Drift	Approx. 15ppm/K
Weight	21g
Ordering Information	Part No: 304.1090.001CA

Power Sink (Option)

The power sink option features returned power to be terminated very quickly. The power sink records the output power status and guarantees a constant output voltage. The power sink also provides quicker response time on setting down the output voltage.

Applications sample: DC-drives & ATE test systems

Most of modern dc-drives are controlled by a PWM (pulse wide modulation) controller. Such controllers feature a very flexible speed control and high efficiency. A disadvantage of PWM controlled drives is the returned power into the system while decelerating the motor. The dragging of the motor inverts the drive into a generator. The returned power may cause trouble or serious defects to the dc-system, but definitely slows down the decelerating process of a drive. The returned energy is not terminated quickly enough and results in rising system voltage. An integrated load, called power sink, terminates the returned power very quickly and enables the drive to small dynamic latency (see figure).

ATE test-systems require quick down programming of the output voltage. Most ATE applications need to drag down the output voltage to 0V as a new testee is put into the system. A power supply without a power sink is simply not quick enough to terminate the energy at the output capacitors. Therefore an electronic power sink manages the output voltage to reset very quickly. Overall test time is being reduced and the testee is uncontrolled transient voltage protected.

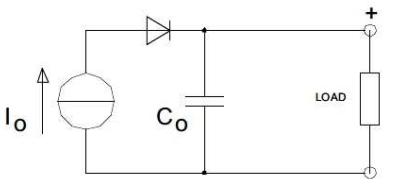

Conventional power supply circuit simplified, without power sink

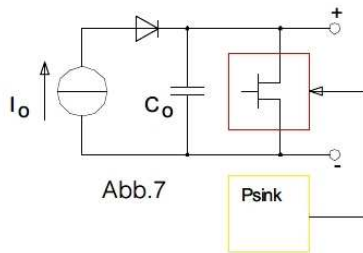

Power sink equipped power supply

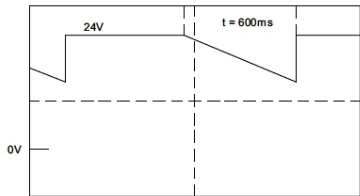

Latency of conventional power supply

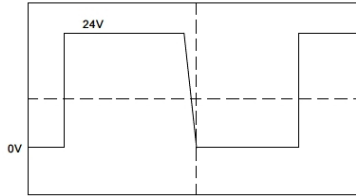

Latency of power sink equipped power supply

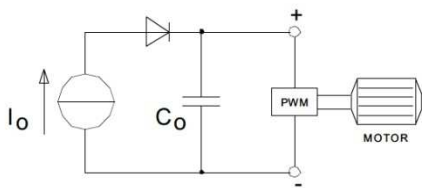

Conventional power supply: braking power charges output capacitor C_o

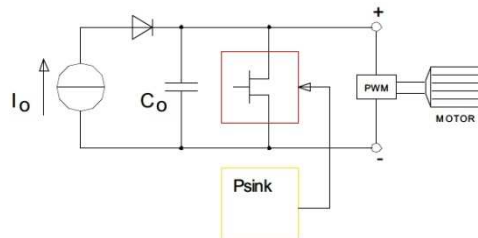

Power sink equipped power supply: absorbs braking energy

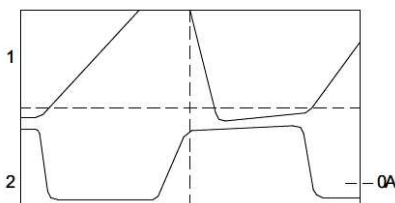

Dynamic reaction of conventional power supply: uncontrolled voltage rises with negative reverse current

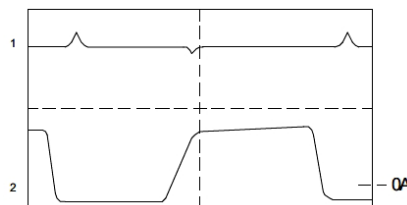

Dynamic reaction of power sink equipped power supply: load current switches between positive and negative

Dynamic response

A common power supply is usually not designed to absorb returned power from its connected load.

The negative load current will recharge the capacitor C_o . The output voltage starts rising and get out of control.

This is essential to the mathematic formula $dv/dt=i/C$.

As an electronic power sink module is equipped to the power supply unit, the output voltage will constantly being kept at the desired level. The power sink provides very quick dynamic response. The output voltage only rises to a minimal notching ratio for a very short spell.

Using a power supply unit without equipped power sink in such application may result into serious damage or uncontrolled OVP activity to the power supply unit.



Technical Data	
Outline	Factory built in
Continuous Power Capability	5W
Peak Power Capability	10W (100ms)

Coating Option

We offer the USEUIreg-series with optional coating. It is to be used in e.g. dusty, dirty, high humidity, or in awaiting quick temperature changes. Short circuit and corrosion at print board lines and at solder points can be prevented. The coat itself is a transparent acrylic resin. It is procured with a robotics varnishing machine.

Peters SL 1306 N-FLZ (transparent) IEC60216-1 2001, IPC-CC-830B, UL listed as permanent coating FileNo.: E80315 , UL94V-0

Ordering Information: ad extension C to the type number: HSEUIreg07201.180TC

Test	Time	A	B	C ¹⁾	D
Type Test	60s	2500Vac	3000Vac	500Vdc	500Vdc
Factory Test	5s	2000Vac	2000Vac	500Vdc	500Vdc
Field Test	2s	2000Vac	2000Vac	500Vdc	500Vdc

¹⁾ $\geq 90Vdc = 1500Vac$

Type test and factory tests are conducted by the manufacturer. Do not repeat the test in field. Field test rules:

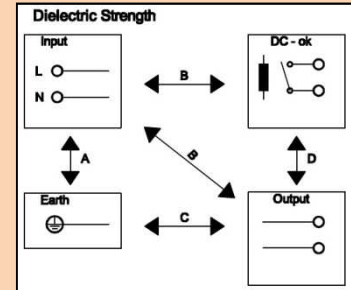

- Use appropriate test equipment which apply the voltage with a slow ramp
- Connect L1 and N together, as well as all output poles
- Use only AC test-voltages with 50/60Hz. The output voltages is floating and has no ohmic reference to ground.
- If testing output voltages are $\geq 60Vdc$ remain to security directives. Use only isolated screw drivers to adjust output voltages.

Terminal Connects:

AC Main Input

GND common
N - wire
L - wire

DC Mains Outputs

DC + voltage
DC - voltage
DC - voltage

Inputs/Outputs

Ureg = programmable voltage input
Ireg = programmable current input
Umon = voltage monitor output
Imon = current monitor output
SD = shut down input
Uref = reference voltage (poti connection)

Standard Feature Connects

C= external power sink
B= sense connections (S+/-) & operation failure relay (output)

Mechanics & Installation of the HSEUIreg

Stable metal/aluminium housing IP20. To allow adequate convection, a free air space of 50mm (top/bottom) and 5mm (sidewalls) is required; for active devices 15mm space from the sidewalls. For free air convection it is necessary to install the HSEUIreg horizontal. You can use the DIN-Rail installation (equiped standard) with our patented 35mm DIN-Rail bracket according to EN60275. It is easy to mount/dismount while snapping it onto the 35mm DIN-Rail - any tools necessary. A wallmount backplate (option) is available, too

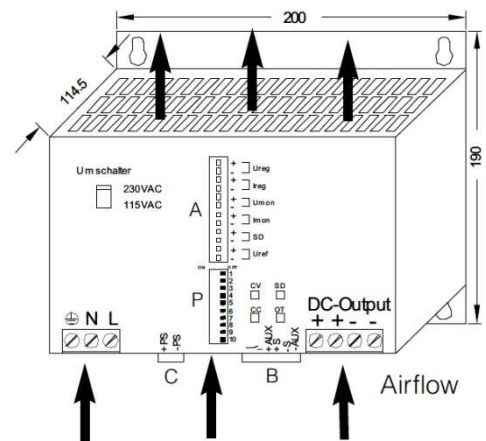
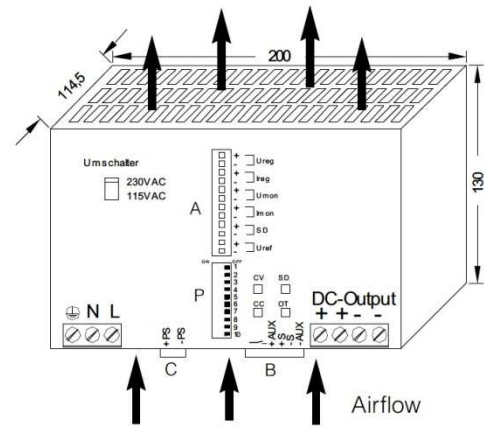
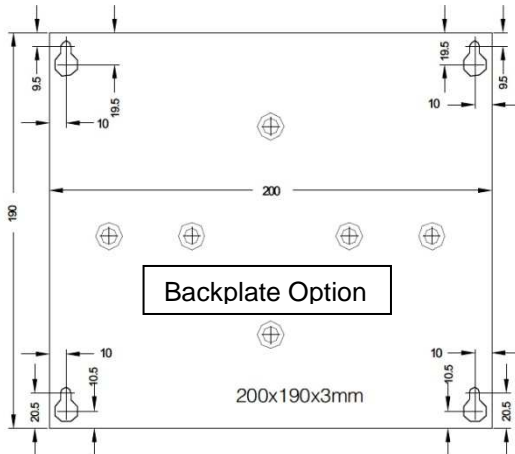
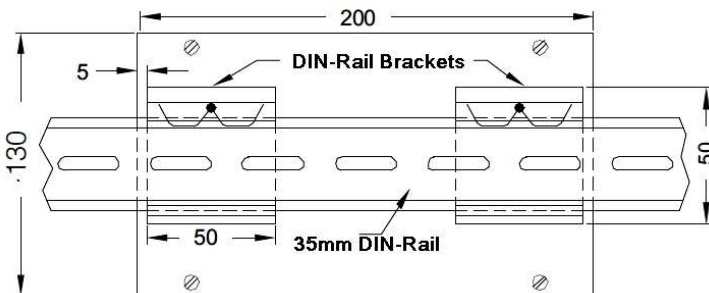

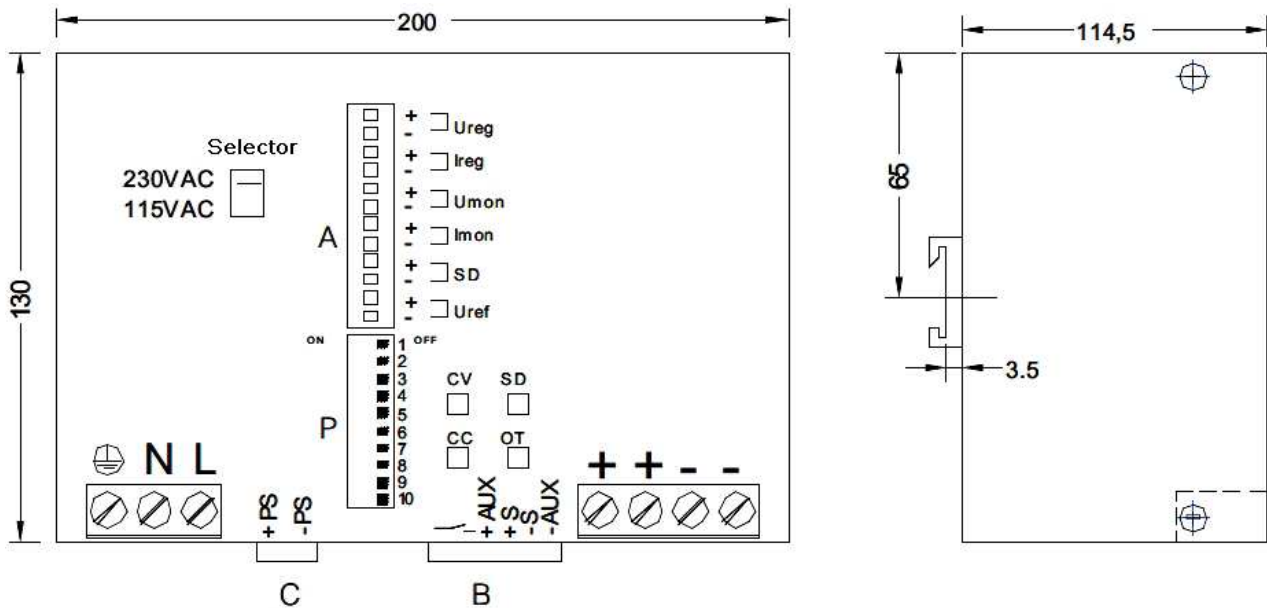

Safety Instructions: Please read all warnings and advices carefully before installing or operating the HSEUreg. Retain this operation manual always ready to hand. The HSEUreg must be installed by specialist staff only.

Installation:

- 1.) The HSEUreg is designed for systems fulfilling the safety norms of dangerous voltages/energy and fire prevention
- 2.) Installation is restricted to specialists only, make sure that the AC wire system is free of voltage
- 3.) Opening the HSEUreg, making any modifications to it, dismantling any screws from it, operating the HSEUreg out of specification and/or using it in appropriate area will inevitably result in losing manufactureres guarantee; we decline taking any responsibility for risk of damages caused to someones health or to any installed system.
- 4.) Attention: The HSEUreg has an internal input fuse. It is necessary to wire an automatic circuit braker to the line. We suggest to use a 16A-type with B-characteristic. It is verboten to operate the HSEUreg without protective earth wired. It essential to install a line switch before the HSEUreg.

Warnings:

Disregard these warnings can cause fire, electric shock, serious accident and death.

1. Never operate the HSEUreg without Protective Earth Conductor
2. Before connecting the HSEUreg to the AC wire system make all wires free of voltage and assure accidently switch on
3. Allow neat and professional cabling
4. Never open nor try to repair the HSEUreg by yourself. Inside are dangerous voltages that can cause electric shock hazard.
5. Avoid metal pieces or other conductive material to fall into the HSEUreg
6. Do not operate the HSEUreg under damp or wet conditions
7. It is verboten to operate the HSEUreg under Ex conditions or i  Area

All parameters base on 15 minutes run-in @ full load / 25°C / 230Vac 50/60Hz, as otherwise stated.