

Ejector Header 2.54mm



RoHS

Ejector Header 2.54mm SMT/Right Angle/Straight Type

Specifications

Current Rate: 3AMP
 Insulation Resistance: 1000MΩ Min.
 Contact Resistance: 20mΩ Max.
 Dielectric Voltage: 1000V AC for one minute
 Operation Temperature: -40°C to +105°C

Material

Insulator: Polyester, UL 94V-0
 ©Standard: PBT or Nylon 6T
 Terminal: Copper Alloy
 Plating: Gold Plated

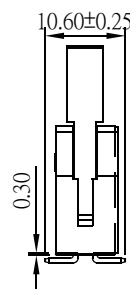
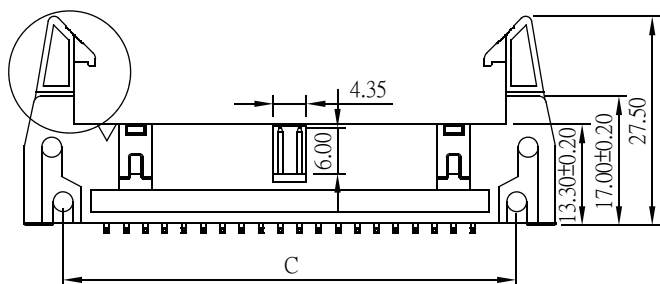
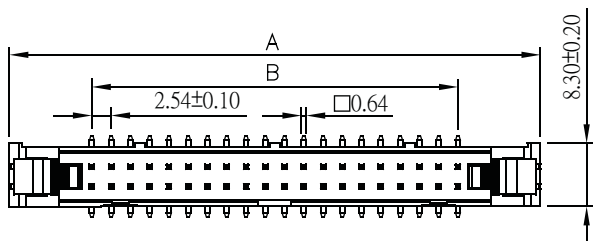
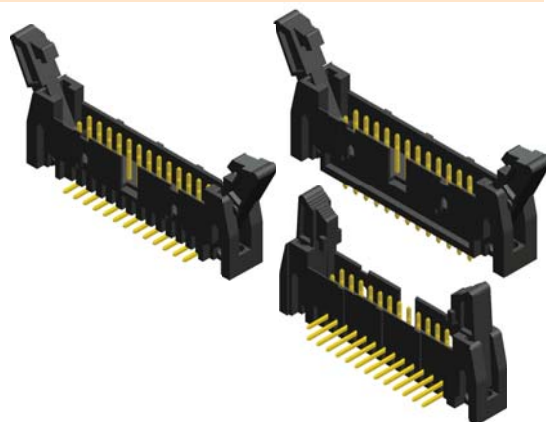

No. of Contacts	Dim. A	Dim. B	Dim. C
10	31.90	10.16	21.70
14	36.98	15.24	26.78
16	39.52	17.78	29.32
20	44.60	22.86	34.40
26	52.22	30.48	42.02
30	57.30	35.56	47.10
34	62.38	40.64	52.18
40	70.00	48.26	59.80
50	82.70	60.96	72.50
60	95.40	73.66	85.20
64	100.48	78.74	90.28

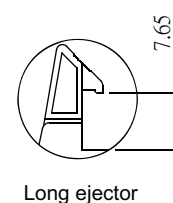
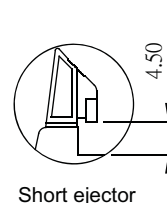
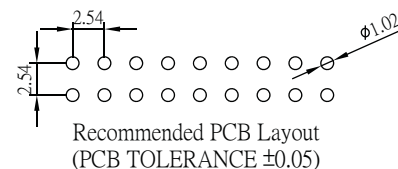
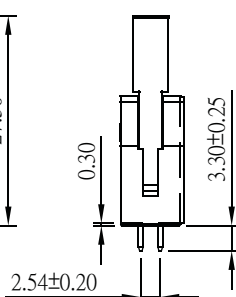
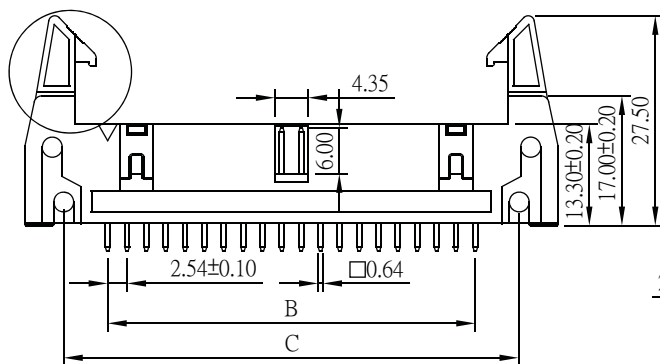
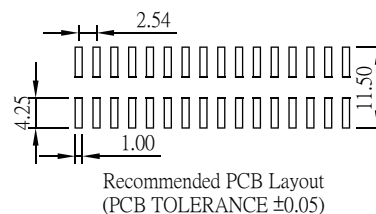
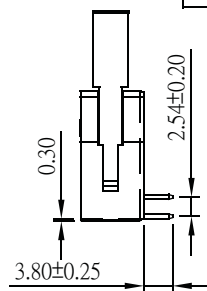
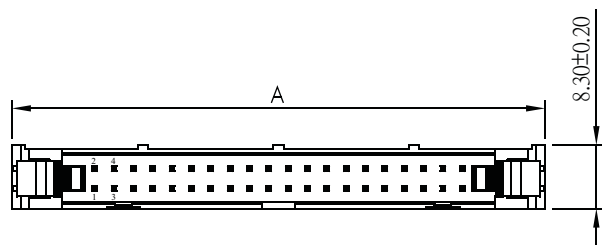

ORDER INFORMATION

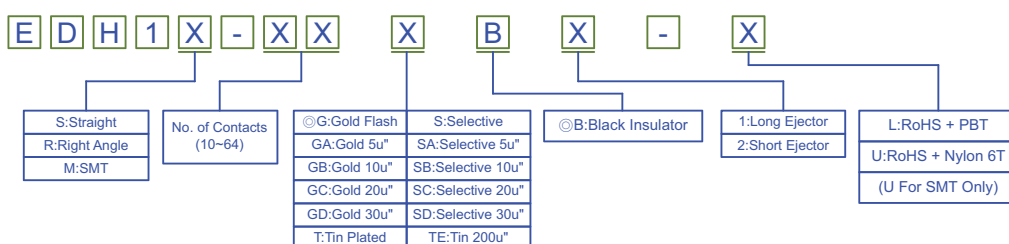

©: Standard Recommended