

# Quad Line Receiver

The MC10H115 is a quad differential amplifier designed for use in sensing differential signals over long lines. This 10H part is a functional/ pinout duplication of the standard MECL 10K family part, with 100% improvement in counting frequency and no increase in power-supply current.

The base bias supply ( $V_{BB}$ ) is made available at Pin 9 to make the device useful as a Schmitt trigger, or in other applications where a stable reference voltage is necessary. Active current sources provide the MC10H115 with excellent common mode rejection. If any amplifier in a package is not used, one input of that amplifier must be connected to  $V_{BB}$  (Pin 9) to prevent upsetting the current source bias network.

- Propagation Delay, 1.0 ns Typical
- Power Dissipation 110 mW Typ/Pkg (No Load)
- Improved Noise Margin 150 mV (Over Operating Voltage and Temperature Range)
- Voltage Compensated
- MECL 10K-Compatible

### MAXIMUM RATINGS

Characteristic	Symbol	Rating	Unit
Power Supply ( $V_{CC} = 0$ )	$V_{EE}$	-8.0 to 0	Vdc
Input Voltage ( $V_{CC} = 0$ )	$V_I$	0 to $V_{EE}$	Vdc
Output Current — Continuous — Surge	$I_{out}$	50 100	mA
Operating Temperature Range	$T_A$	0 to +75	°C
Storage Temperature Range — Plastic — Ceramic	$T_{stg}$	-55 to +150 -55 to +165	°C

### ELECTRICAL CHARACTERISTICS ( $V_{EE} = -5.2 V \pm 5\%$ ) (2)

Characteristic	Symbol	0°		25°		75°		Unit
		Min	Max	Min	Max	Min	Max	
Power Supply Current	$I_E$	—	29	—	26	—	29	mA
Input Current High	$I_{inH}$	—	150	—	95	—	95	μA
Input Leakage Current	$I_{CBO}$	—	1.5	—	1.0	—	1.0	μA
Reference Voltage	$V_{BB}$	-1.38	-1.27	-1.35	-1.25	-1.31	-1.19	Vdc
High Output Voltage	$V_{OH}$	-1.02	-0.84	-0.98	-0.81	-0.92	-0.735	Vdc
Low Output Voltage	$V_{OL}$	-1.95	-1.63	-1.95	-1.63	-1.95	-1.60	Vdc
High Input Voltage (1)	$V_{IH}$	-1.17	-0.84	-1.13	-0.81	-1.07	-0.735	Vdc
Low Input Voltage (1)	$V_{IL}$	-1.95	-1.48	-1.95	-1.48	-1.95	-1.45	Vdc
Common Mode Range (3)	$V_{CMR}$	—	—	-2.85 to -0.8	—	—	—	Vdc
Input Sensitivity (4)	$V_{PP}$	—	—	150 typ	—	—	—	mV <sub>pp</sub>

### AC PARAMETERS

Parameter	Symbol	0.4	1.3	0.4	1.3	0.45	1.45	ns
Propagation Delay	$t_{pd}$							
Rise Time	$t_r$	0.5	1.4	0.5	1.5	0.5	1.6	ns
Fall Time	$t_f$	0.5	1.4	0.5	1.5	0.5	1.6	ns

### NOTES:

1. When  $V_{BB}$  is used as the reference voltage.
2. Each MECL 10H series circuit has been designed to meet the specifications shown in the test table, after thermal equilibrium has been established. The circuit is in a test socket or mounted on a printed circuit board and transverse air flow greater than 500 linear fpm is maintained. Outputs are terminated through a 50-ohm resistor to -2.0 volts.
3. Differential input not to exceed 1.0 Vdc.
4. 150 mV<sub>p-p</sub> differential input required to obtain full logic swing on output.

## MC10H115

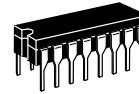

**L SUFFIX**  
CERAMIC PACKAGE  
CASE 620-10

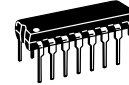

**P SUFFIX**  
PLASTIC PACKAGE  
CASE 648-08



**FN SUFFIX**  
PLCC  
CASE 775-02

### LOGIC DIAGRAM

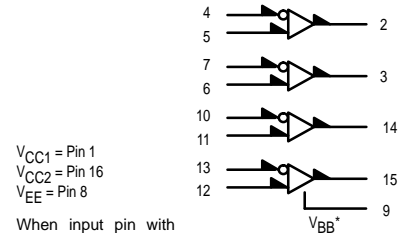

\* $V_{BB}$  to be used to supply bias to the MC10H115 only and bypassed (when used) with 0.01 μF to 0.1 μF capacitor to ground (0 V).  $V_{BB}$  can source < 1.0 mA.

The MC10H115 is designed to be used in sensing differential signals over long lines. The bias supply ( $V_{BB}$ ) is made available to make the device useful as a Schmitt trigger, or in other applications where a stable reference voltage is necessary.

Active current sources provide these receivers with excellent common-mode noise rejection. If any amplifier in a package is not used, one input of that amplifier must be connected to  $V_{BB}$  to prevent unbalancing the current-source bias network.

The MC10H115 does not have internal-input pull-down resistors. This provides high impedance to the amplifier input and facilitates differential connections.

#### Applications:

- Low Level Receiver
- Voltage Level Interface
- Schmitt Trigger

### DIP PIN ASSIGNMENT

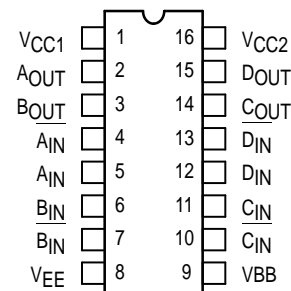

Pin assignment is for Dual-in-Line Package. For PLCC pin assignment, see the Pin Conversion Tables on page 6-11 of the Motorola MECL Data Book (DL122/D).



OUTLINE DIMENSIONS

FN SUFFIX  
 PLASTIC PLCC PACKAGE  
 CASE 775-02  
 ISSUE C

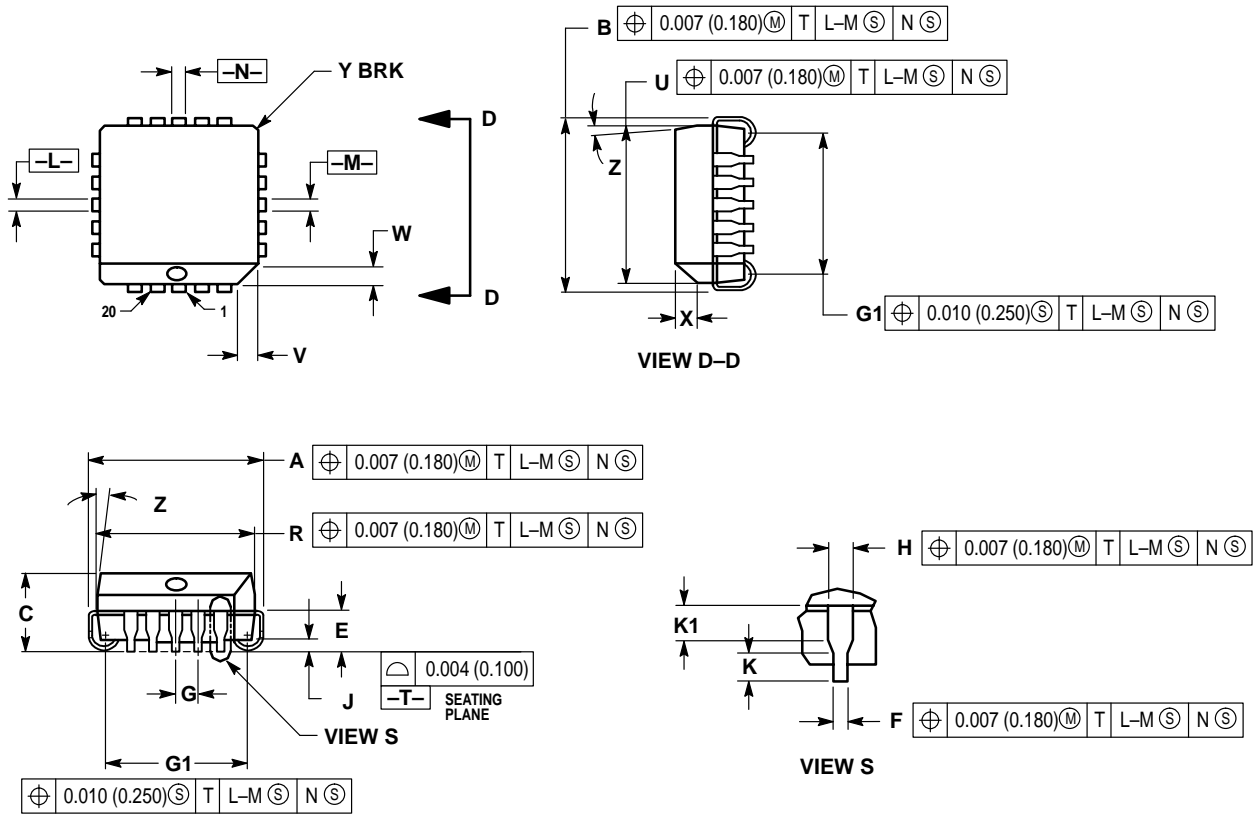

- NOTES:
- DATUMS -L-, -M-, AND -N- DETERMINED WHERE TOP OF LEAD SHOULDER EXITS PLASTIC BODY AT MOLD PARTING LINE.
  - DIMENSION G1, TRUE POSITION TO BE MEASURED AT DATUM -T-, SEATING PLANE.
  - DIMENSIONS R AND U DO NOT INCLUDE MOLD FLASH. ALLOWABLE MOLD FLASH IS 0.010 (0.250) PER SIDE.
  - DIMENSIONING AND TOLERANCING PER ANSI Y14.5M, 1982.
  - CONTROLLING DIMENSION: INCH.
  - THE PACKAGE TOP MAY BE SMALLER THAN THE PACKAGE BOTTOM BY UP TO 0.012 (0.300). DIMENSIONS R AND U ARE DETERMINED AT THE OUTERMOST EXTREMES OF THE PLASTIC BODY EXCLUSIVE OF MOLD FLASH, TIE BAR BURRS, GATE BURRS AND INTERLEAD FLASH, BUT INCLUDING ANY MISMATCH BETWEEN THE TOP AND BOTTOM OF THE PLASTIC BODY.
  - DIMENSION H DOES NOT INCLUDE DAMBAR PROTRUSION OR INTRUSION. THE DAMBAR PROTRUSION(S) SHALL NOT CAUSE THE H DIMENSION TO BE GREATER THAN 0.037 (0.940). THE DAMBAR INTRUSION(S) SHALL NOT CAUSE THE H DIMENSION TO BE SMALLER THAN 0.025 (0.635).

DIM	INCHES		MILLIMETERS	
	MIN	MAX	MIN	MAX
A	0.385	0.395	9.78	10.03
B	0.385	0.395	9.78	10.03
C	0.165	0.180	4.20	4.57
E	0.090	0.110	2.29	2.79
F	0.013	0.019	0.33	0.48
G	0.050 BSC		1.27 BSC	
H	0.026	0.032	0.66	0.81
J	0.020	—	0.51	—
K	0.025	—	0.64	—
R	0.350	0.356	8.89	9.04
U	0.350	0.356	8.89	9.04
V	0.042	0.048	1.07	1.21
W	0.042	0.048	1.07	1.21
X	0.042	0.056	1.07	1.42
Y	—	0.020	—	0.50
Z	2°	10°	2°	10°
G1	0.310	0.330	7.88	8.38
K1	0.040	—	1.02	—

OUTLINE DIMENSIONS

L SUFFIX  
CERAMIC DIP PACKAGE  
CASE 620-10  
ISSUE V

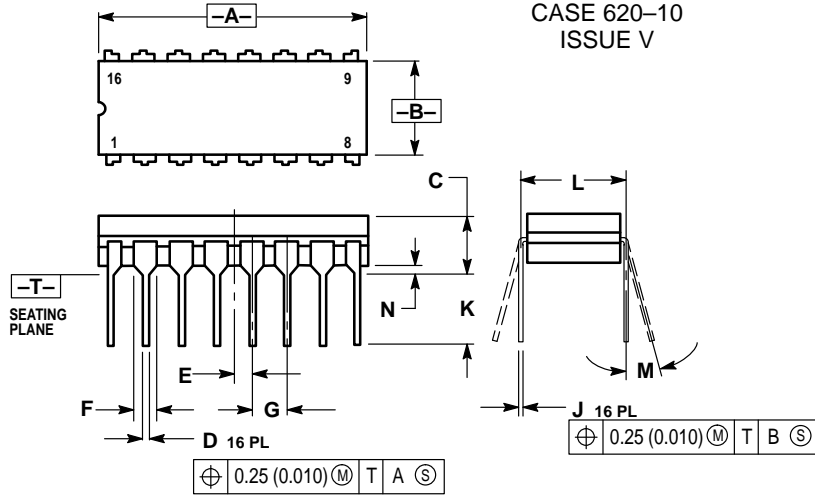

- NOTES:
1. DIMENSIONING AND TOLERANCING PER ANSI Y14.5M, 1982.
  2. CONTROLLING DIMENSION: INCH.
  3. DIMENSION L TO CENTER OF LEAD WHEN FORMED PARALLEL.
  4. DIMENSION F MAY NARROW TO 0.76 (0.030) WHERE THE LEAD ENTERS THE CERAMIC BODY.

DIM	INCHES		MILLIMETERS	
	MIN	MAX	MIN	MAX
A	0.750	0.785	19.05	19.93
B	0.240	0.295	6.10	7.49
C	—	0.200	—	5.08
D	0.015	0.020	0.39	0.50
E	0.050 BSC		1.27 BSC	
F	0.055	0.065	1.40	1.65
G	0.100 BSC		2.54 BSC	
H	0.008	0.015	0.21	0.38
K	0.125	0.170	3.18	4.31
L	0.300 BSC		7.62 BSC	
M	0°	15°	0°	15°
N	0.020	0.040	0.51	1.01

P SUFFIX  
PLASTIC DIP PACKAGE  
CASE 648-08  
ISSUE R

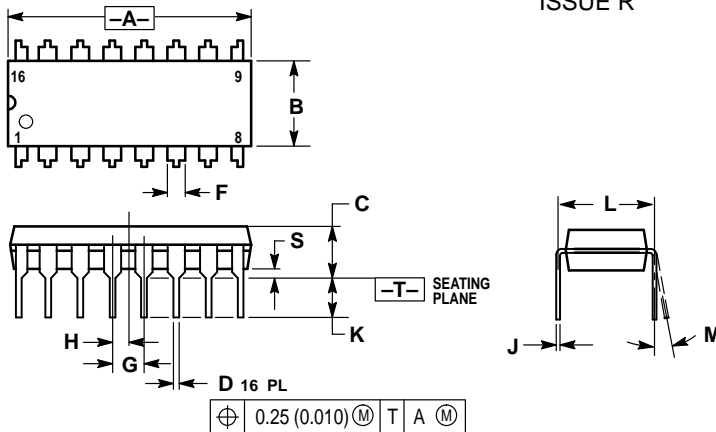

- NOTES:
1. DIMENSIONING AND TOLERANCING PER ANSI Y14.5M, 1982.
  2. CONTROLLING DIMENSION: INCH.
  3. DIMENSION L TO CENTER OF LEADS WHEN FORMED PARALLEL.
  4. DIMENSION B DOES NOT INCLUDE MOLD FLASH.
  5. ROUNDED CORNERS OPTIONAL.

DIM	INCHES		MILLIMETERS	
	MIN	MAX	MIN	MAX
A	0.740	0.770	18.80	19.55
B	0.250	0.270	6.35	6.85
C	0.145	0.175	3.69	4.44
D	0.015	0.021	0.39	0.53
F	0.040	0.70	1.02	1.77
G	0.100 BSC		2.54 BSC	
H	0.050 BSC		1.27 BSC	
J	0.008	0.015	0.21	0.38
K	0.110	0.130	2.80	3.30
L	0.295	0.305	7.50	7.74
M	0°	10°	0°	10°
S	0.020	0.040	0.51	1.01

Motorola reserves the right to make changes without further notice to any products herein. Motorola makes no warranty, representation or guarantee regarding the suitability of its products for any particular purpose, nor does Motorola assume any liability arising out of the application or use of any product or circuit, and specifically disclaims any and all liability, including without limitation consequential or incidental damages. "Typical" parameters which may be provided in Motorola data sheets and/or specifications can and do vary in different applications and actual performance may vary over time. All operating parameters, including "Typicals" must be validated for each customer application by customer's technical experts. Motorola does not convey any license under its patent rights nor the rights of others. Motorola products are not designed, intended, or authorized for use as components in systems intended for surgical implant into the body, or other applications intended to support or sustain life, or for any other application in which the failure of the Motorola product could create a situation where personal injury or death may occur. Should Buyer purchase or use Motorola products for any such unintended or unauthorized application, Buyer shall indemnify and hold Motorola and its officers, employees, subsidiaries, affiliates, and distributors harmless against all claims, costs, damages, and expenses, and reasonable attorney fees arising out of, directly or indirectly, any claim of personal injury or death associated with such unintended or unauthorized use, even if such claim alleges that Motorola was negligent regarding the design or manufacture of the part. Motorola and  are registered trademarks of Motorola, Inc. Motorola, Inc. is an Equal Opportunity/Affirmative Action Employer.

How to reach us:

USA/EUROPE/Locations Not Listed: Motorola Literature Distribution; P.O. Box 20912; Phoenix, Arizona 85036. 1-800-441-2447 or 602-303-5454

MFAX: RMFAX0@email.sps.mot.com – TOUCHTONE 602-244-6609  
INTERNET: <http://Design-NET.com>

JAPAN: Nippon Motorola Ltd.; Tatsumi-SPD-JLDC, 6F Seibu-Butsuryu-Center, 3-14-2 Tatsumi Koto-Ku, Tokyo 135, Japan. 03-81-3521-8315

ASIA/PACIFIC: Motorola Semiconductors H.K. Ltd.; 8B Tai Ping Industrial Park, 51 Ting Kok Road, Tai Po, N.T., Hong Kong. 852-26629298



This datasheet has been download from:

[www.datasheetcatalog.com](http://www.datasheetcatalog.com)

Datasheets for electronics components.