

# HPW02401

# DIN Rail

Made in Germany

**240W (312W) Power Supply -25...+70°C**  
**85..264Vac active PFC & active inrush protection**

## Short Specification:

- Metal housing
- 91.5% efficiency
- -25°C...+70°C ambient
- Free air convection
- Galvanic insulated
- Continuous short circuit protected
- Overload & low voltage protected
- Soft start & auto-recovery
- Hold up time >40ms
- Minimum load = 0A
- Electronic Inrush Current Limiter <7A
- EMI/EMS EN61000-6-2/3, EN55022 class B
- Active PFC: EN61000-3-2
- According to cUL60950, IEC(EN)60950-1
- Low voltage & overload control message
- Remote ON/OFF
- DIN Rail 35mm
- Screw terminals AWG20...AWG12
- High reliability, shock & vibration resistant
- Output Electrolytic Capacitors +125°C

## Smart start-up with critical loads:

- motor drives
- capacitive loads
- DC-DC-converters
- Batteries



**Single-Out: 9...18V, 18...30V, 30...43V,**  
**43...53V, 53...72V, 68...86V**



In accordance with IEC60950-1

AC Input	85...264Vac , 47...63Hz , 90...350Vdc					
AC Input Rating	100...240Vac , 115Vac <2.6A 230Vac <1.3A					
DC Voltage Adjust	9...18Vdc(12V)	18...30Vdc(24V)	30...43Vdc(36V)	43...53Vdc(48V)	53...72Vdc(60V)	68...86Vdc(72V)
Over Voltage Protection	21Vdc	35Vdc	50Vdc	60Vdc	84Vdc	97Vdc
Rated Current 60°C	15.0A (12Vdc)	10.0A (24Vdc)	6.7A (36Vdc)	5.0A (48Vdc)	4.0A (60Vdc)	3.3A (72Vdc)
Rated Current 40°C	19.0A (12Vdc)	13.0A (24Vdc)	8.7A (36Vdc)	6.5A (48Vdc)	5.2A (60Vdc)	4.3A (72Vdc)
Boost 60s/60°C	18.0A (12Vdc)	12.0A (24Vdc)	8.0A (36Vdc)	6.0A (48Vdc)	4.8A (60Vdc)	4.0A (72Vdc)
Ripple mVpp/230Vac	30 (20MHz)	30 (20MHz)	60 (20MHz)	50 (20MHz)	50 (20MHz)	60mV
Load regulation 0-100%	±0.5%	±0.2%	±0.2%	±0.2%	±0.2%	±0.2%

Tolerance Ua adjusted	± 0.5%
Transient Time	<1ms (10-100% , 100-10%)
Minimum Load	0 A
Efficiency	91.5% typical
Load Protection	1,2x I <sub>rated</sub> , auto recovery
Short Circuit Protection	Yes
Temperature Controlled	Yes (see right graph)
Hold Up Time	> 40ms (100...230Vac input)
Inrush Current	< 7A (230Vac), active limiter
Softstart	50ms typical
Cooling	Natural convection
Ambient Temperature	- 25°C...+70°C
Storage Temperature	- 40°C...+85°C
EMI	EN55022 class B / EN61000-3-2
EMS	EN61000-6-2,3 active PFC
Safety	cUL60950 , (IEC)EN60950-1
Safety class 1(A)	VDE0805, VDE0100
Air & Surface Leakage Paths	> 8mm
Input/Output	Galvanic insulated
DC Fail Relay (galv. insulated)	≤48Vdc/500mA , ≤30Vac/500mA
Relative Humidity	95% (25°C) non-condensing
Pollution Degree	2 (EN50178)
Climatic Class	3k3 (EN60721)
MTBF (IEC61709)	500000h
Dimensions (HxWxD)	130x75x115mm
Weight	1200g
Connectors (AC & DC)	AWG20...AWG6
(see page 4)	IEC60664-1, IEC61984

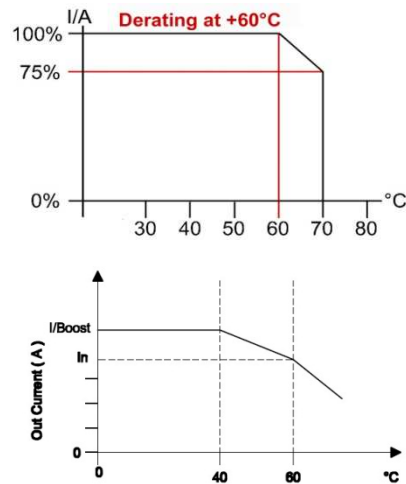

For further derating information see table page 3

#### Temperature Control:

If the ambient temperature ( $t_a$ )  $\leq 40^\circ\text{C}$  the HPW provides I/Boost continuously and if  $t_a \leq 60^\circ\text{C}$  I<sub>rated</sub> is provided continuously. If  $t_a > 60^\circ\text{C}$  derating continuously lowers V<sub>out</sub> 2,5%/Kelvin. If  $t_a > 70^\circ\text{C}$  (or thermal overload occurs) the HPW shuts down. It auto-recovers when the device cools down to approved operation conditions.

#### Specification:

The HPW02401 DIN Rail power supply series is designed for worldwide electronics applications like machine building, railway, military and factory automation. Its regulated DC output with ripple/noise lower than 30mVpp and its high efficiency of 91.5% makes the HPW robust, economical and reliable. Camtec power supplies are traditionally made with high end low ESR electrolytic output capacitors with withstanding +125°C temperature. Our capacities are rather designed over for longer lifetime and longer hold up times. The power boost of the HPW starts DC-loads and DC-motors reliable. The built in function diagnostics detects malfunctions. The galvanic insulated DC fail relay and remote on/off provides full control over the power supply unit. The HPW is short circuit and zero load stability protected. It is protected against high transient and provides very good interference resistance. Equal types of the HPW02401 can be operated in parallel or in series connection. We use IP20 stable aluminium housings with ventilation slots in accordance to the demanding VDE norms. The design meets EN (IEC)60950-1 and low voltage directive EN55022 Class B.

#### Block Diagram

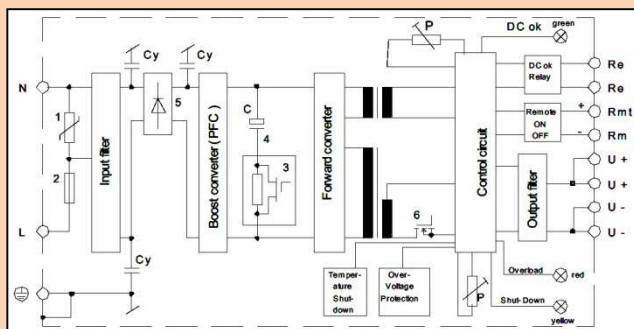

- 1) Transient suppressor (VDR)
- 2) AC fuse
- 3) Electronic Inrush Current Limiter
- 4) Load Capacitor C
- 5) Rectifier & Active PFC
- P Potentiometer

Complex sane filter technology using 2 varistors, noise suppression chokes and X1 capacitors, apply major transient resistance to the input filter. The synchron rectifier increases the efficiency of the APW crucial. Compared to diode rectifying the power dissipation drops to a minimum. The emission is much lower to result in a longer lifetime of the APW power supply.

**Overload:** If 0.9xV<sub>out</sub> applies to the outputs, the red LED lights and the DC-OK-Relay (Re) drops (control message). The green DC-OK LED is off.

### Remote On/Off

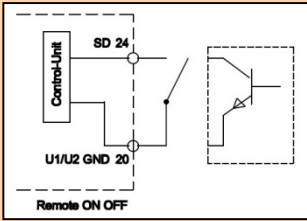

Enable a 10...30Vdc 20mA voltage signal to (Rmt/Rm) to shutdown the HPW, the yellow LED lights and 0V is distributed to the outputs. If the shutdown is short circuited or <math><500\text{mV}</math> are applied to (Rmt/Rm), the HPW „tickers“, the yellow LED flashes and 5V is distributed to the outputs. Disable the remote voltage to restart the PSU

### DC o.k. Message

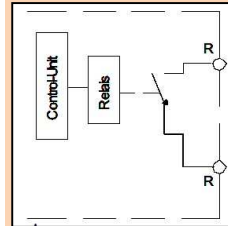

**Low Voltage:**  
If adjusted Vout drops 10% the red LED lights and the DC-OK-Relay (Re) drops (control message). The green DC-OK LED is off.  
**Overload:** If  $0.9 \times V_{out}$  applies to the outputs, the red LED lights and the DC-OK-Relay (Re) drops (control message). The green DC-OK LED is off.  
Vout o.k. = relay closed  
Vout fail = relay open

### Series Connection

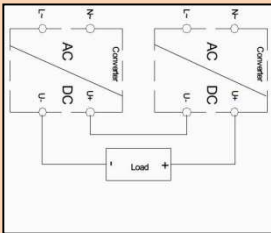

To increase the output power, equal HPW devices can be used series connected. Observe to safety directives when the output voltage achieves 60Vdc in sum.

### Redundant Connection

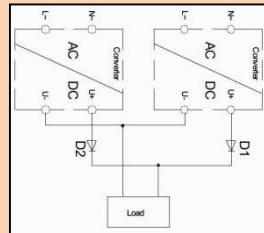

To increase system availability up to five HPW can be used in parallel operation mode. Please make sure that wiring length from all units to the load is equal. Full redundant operation modes require external diodes. We suggest to use our RED00202 DIN-Rail N+1 redundant module für professional redundancy.

### Inrush Current Limitation (Block Diagram)

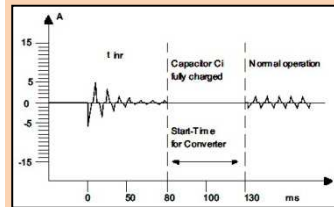
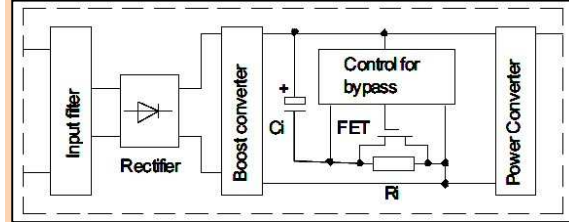

While connecting the HPW to the AC wire network its inrush current is limited to <math><7\text{A}</math> (typ.). The start capacitors are loaded after 80ms and the HPW actuates. After passing softstart (active PFC) the power supply is ready for operation after a total of  $t=130\text{ms}$ .  
**Characteristics  $V_i=230\text{Vac}$ :**  
Peak Inrush Current = <math><7\text{A}</math> (typ.)  
Peak Limiting Duration = 80ms

### Power Boost and Temperature Behaviour

The HPW02401 operates in accordance to the V/C-characteristic line (see graph I/Boost on page 2). It has a determinate power reserve (boost): With ambient temperatures  $\leq 40^\circ\text{C}$  the power boost is continuously available while with higher ambient temperatures it is available for a few minutes. When a DC short circuit or an overload occurs to the HPW02401, it is limited to I/Boost (see graph) but it is not shot down. The DC-voltage is lowered until the error is rectified. The V/C-line and the powerboost applies operation of critical loads, like DC-DC-converters, capacitive loads, drives and batteries, trustworthy.

### Output voltage/current ratio to ambient ( $U/I$ to $^\circ\text{C}$ )

Uout	40°C/Iout	60°C/Iout	Uout	40°C/Iout	60°C/Iout
9Vdc	19,0A	15,0A	32Vdc	8,7A	7,5A
12Vdc	19,0A	15,0A	34Vdc	8,7A	7,1A
15Vdc	17,1A	13,5A	36Vdc	8,7A	6,7A
18Vdc	15,6A	12,0A	40Vdc	7,8A	6,0A
20Vdc	13,0A	11,3A	46Vdc	6,8A	5,2A
22Vdc	13,0A	10,7A	53Vdc	5,9A	4,5A
24Vdc	13,0A	10,0A	60Vdc	5,2A	4,0A
26Vdc	12,0A	9,2A	65Vdc	4,8A	3,7A
28Vdc	11,2A	8,6A	72Vdc	4,3A	3,3A
30Vdc	10,4A	8,0A	86Vdc	3,6A	2,8A

Test Type	Time	A	B	C	D
Test	60s	2500Vac	3000Vac	500Vdc	500Vdc
Factory Test	5s	2000Vac	2000Vac	500Vdc	500Vdc
Field Test	2s	2000Vac	2000Vac	500Vdc	500Vdc

Type test and factory tests are conducted by the manufacturer. Do not repeat the test in field. Field test rules:

- Use appropriate test equipment which apply the voltage with a slow ramp
- Connect L1 and N together, as well as all output poles
- Use only AC test-voltages with 50/60Hz. The output voltages is floating and has no ohmic reference to ground.
- If testing output voltages are  $\geq 60\text{Vdc}$  remain to security directives. Use only isolated screw drivers to adjust output voltages.

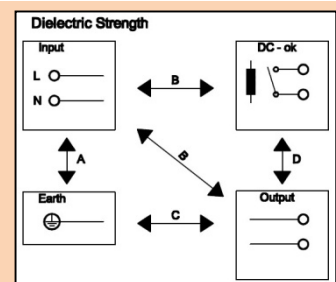

### Function Table and Messages

Indicators	DC-ok LED green	Overload LED red	Shutdown LED yellow	DC-ok Relay
Normal operation	On	Off	Off	Closed
Powerboost	On	Off	Off	Closed
Overload (0.9xVout)	Off	On	Off	Open
Shutdown with open contact	On	Off	Off	Closed
Shutdown with 10...30Vdc	Off	Off	On	Open
Shutdown with <math><500\text{mVdc}</math>	Off	Pulse	Pulse	Open
Temperature shutdown	Off	Off	Off	Open
Input voltage low or fail	Off	Off	Off	Open

<b>Terminal Connects:</b>			
<b>SK1</b>	1 = L 2 = N 3 = GND	<b>SK2</b>	1 = DC + 2 = DC + 3 = DC - 4 = DC -
<b>SK3</b>	A= Remote On/Off (shutdown) B= DC-OK Relay		<b>Screw terminal order codes:</b> DC-fail-relay& Shutdown, one plug for each required (each package = 10 pcs ) Art.No.: 3520037 (2 pins)

**Optional Coating (option C):**

We offer the HPW-Series with optional coating. It is to be used in e.g. dusty, dirty, high humidity, or in awaiting quick temperature changes. Short circuit and corrosion at print board lines and at solder points can be prevented. The coat itself is a transparent acrylic resin. It is procured with a robotics varnishing machine.  
Peters SL 1306 N-FLZ (transparent) IEC60216-1 2001, IPC-CC-830B, UL listed as permanent coating FileNo.: E80315 , UL94V-0

**Order Codes:**

HPW02401.12T	9..18Vdc	DIN-Rail	HPW02401.12W	9..18Vdc	Wallmount
HPW02401.24T	18..30Vdc	DIN-Rail	HPW02401.24W	18..30Vdc	Wallmount
HPW02401.36T	30..43Vdc	DIN-Rail	HPW02401.36W	30..43Vdc	Wallmount
HPW02401.48T	43..53Vdc	DIN-Rail	HPW02401.48W	43..53Vdc	Wallmount
HPW02401.60T	53..72Vdc	DIN-Rail	HPW02401.60W	53..72Vdc	Wallmount
HPW02401.72T	68..86Vdc	DIN-Rail	HPW02401.72W	68..86Vdc	Wallmount

**Options to be added to the order-code:**  
C coating  
**Order samples:**  
HPW02401.24TC DIN-Rail+Coating  
HPW02401.24WC Wallmount+Coating

**Mechanics & Installation of the HPW02401:**

Stable metal/aluminium housing IP20. To allow adequate convection, a free air space of 50mm (top/bottom) and 5mm (sidewalls) is required for the HPW02401; for active devices 15mm space from the HPW-sidewalls. For free air convection it is necessary to install the HPW horizontal (**Figure1**). You can use the DIN-Rail installation (equiped standard) with our patented 35mm DIN-Rail bracket according to EN60275. It is easy to mount/dismount while snapping it onto the 35mm DIN-Rail without any tools necessary. It is a wallmount fastener available as option, too.

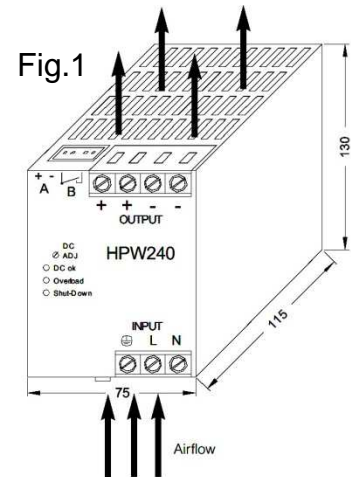
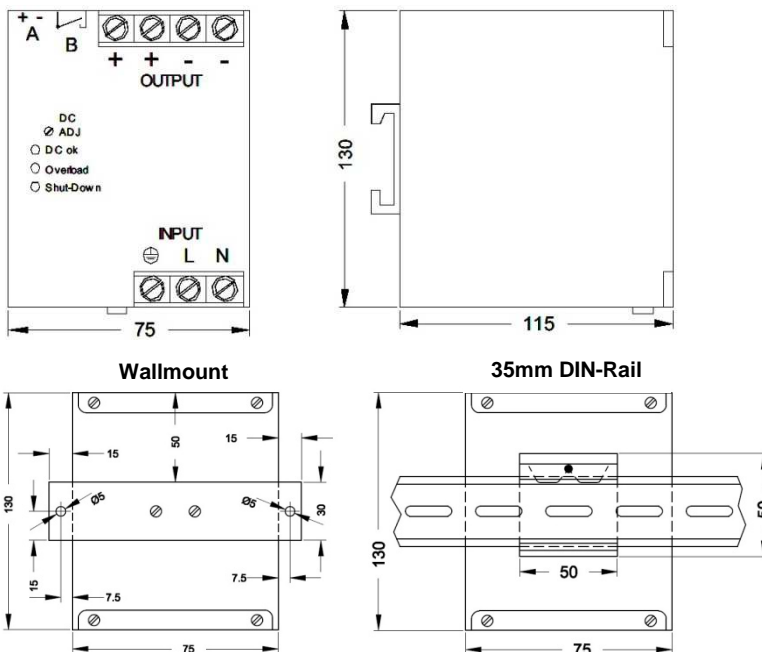

<b>Connectors (IEC60664-1, IEC61984)</b>		
Wiring	Solid	Flexible
AC-Input & DC-Outputs	0,5...6mm <sup>2</sup>	0,5...4mm <sup>2</sup>
Rated Current	20...10 AWG	20...12AWG
	30A	30A
Signal Outputs (A,B)	0,2...2,5mm <sup>2</sup>	0,2...2,5mm <sup>2</sup>
	24...14 AWG	24...14 AWG

**Safety Instructions:** Please read all warnings and advices carefully before installing or operating the HPW. Retain this operation manual always ready to hand. The HPW must be installed by specialist staff only.

**Installation:**

- 1.) The HPW is designed for systems fulfilling the safety norms of dangerous voltages/energy and fire prevention
- 2.) Installation is restricted to specialists only, make sure that the AC wire system is free of voltage
- 3.) Opening the HPW, making any modifications to it, dismantling any screws from it, operating the HPW out of specification and/or using it in appropriate area will inevitably result in loosing manufactureres guarantee; we decline taking any responsibility for risk of damages caused to someones health or to any installed system.
- 4.) Attention: The HPW has an internal input fuse. It is necessary to wire an automatic circuit braker to the line. We suggest to use a 10A-type with B-characteristic. It is verboten to operate the HPW without protective earth wired. It essential to install a line switch before the HPW.

**Warnings:**

Disregard these warnings can cause fire, electric shock, serious accident and death.

1. Never operate the HPW without Protective Earth Conductor
2. Before connecting the HPW to the AC wire system make all wires free of voltage and assure accidently switch on
3. Allow neat and professional cabling
4. Never open nor try to repair the HPW by yourself. Inside are dangerous voltages that can cause electric shock hazard.
5. Avoid metal pieces or other conductive material to fall into the HPW
6. Do not operate the HPW under damp or wet conditions
7. It is verboten to operate the HPW under Ex conditions or in Ex-Area

