

DATA SHEET

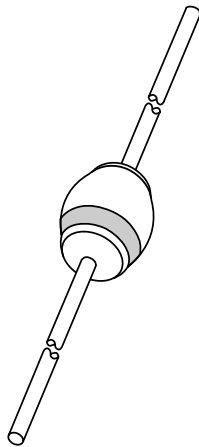

BYV26 series Fast soft-recovery controlled avalanche rectifiers

Product specification
Supersedes data of February 1994

1996 May 30

Fast soft-recovery controlled avalanche rectifiers

BYV26 series

FEATURES

- Glass passivated
- High maximum operating temperature
- Low leakage current
- Excellent stability
- Guaranteed avalanche energy absorption capability
- Available in ammo-pack.

DESCRIPTION

Rugged glass SOD57 package, using a high temperature alloyed construction.

This package is hermetically sealed and fatigue free as coefficients of expansion of all used parts are matched.

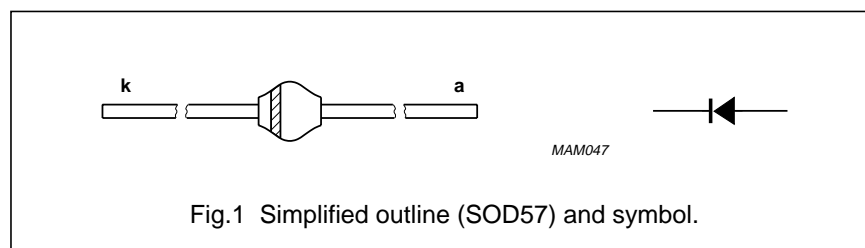

LIMITING VALUES

In accordance with the Absolute Maximum Rating System (IEC 134).

SYMBOL	PARAMETER	CONDITIONS	MIN.	MAX.	UNIT
V_{RRM}	repetitive peak reverse voltage				
	BYV26A		–	200	V
	BYV26B		–	400	V
	BYV26C		–	600	V
	BYV26D		–	800	V
	BYV26E		–	1000	V
	BYV26F BYV26G		–	1200 1400	V V
V_R	continuous reverse voltage				
	BYV26A		–	200	V
	BYV26B		–	400	V
	BYV26C		–	600	V
	BYV26D		–	800	V
	BYV26E		–	1000	V
	BYV26F BYV26G		–	1200 1400	V V
$I_{F(AV)}$	average forward current	$T_{tp} = 85\text{ °C}$; lead length = 10 mm; see Figs 2 and 3;			
	BYV26A to E BYV26F and G	averaged over any 20 ms period; see also Figs 10 and 11	– –	1.00 1.05	A A
$I_{F(AV)}$	average forward current	$T_{amb} = 60\text{ °C}$; PCB mounting (see Fig.19); see Figs 4 and 5;			
	BYV26A to E BYV26F and G	averaged over any 20 ms period; see also Figs 10 and 11	– –	0.65 0.68	A A
I_{FRM}	repetitive peak forward current	$T_{tp} = 85\text{ °C}$; see Figs 6 and 7			
	BYV26A to E BYV26F and G		– –	10.0 9.6	A A

Fast soft-recovery controlled avalanche rectifiers

BYV26 series

SYMBOL	PARAMETER	CONDITIONS	MIN.	MAX.	UNIT
I_{FRM}	repetitive peak forward current	$T_{amb} = 60\text{ °C}$; see Figs 8 and 9	–	6.0	A
	BYV26A to E BYV26F and G			6.4	A
I_{FSM}	non-repetitive peak forward current	$t = 10\text{ ms}$ half sine wave; $T_j = T_{j\text{ max}}$ prior to surge; $V_R = V_{RRM\text{ max}}$	–	30	A
E_{RSM}	non-repetitive peak reverse avalanche energy	$I_R = 400\text{ mA}$; $T_j = T_{j\text{ max}}$ prior to surge; inductive load switched off	–	10	mJ
T_{stg}	storage temperature		–65	+175	°C
T_j	junction temperature	see Figs 12 and 13	–65	+175	°C

ELECTRICAL CHARACTERISTICS

$T_j = 25\text{ °C}$ unless otherwise specified.

SYMBOL	PARAMETER	CONDITIONS	MIN.	TYP.	MAX.	UNIT				
V_F	forward voltage	$I_F = 1\text{ A}$; $T_j = T_{j\text{ max}}$; see Figs 14 and 15	–	–	1.3	V				
	BYV26A to E BYV26F and G				1.3	V				
V_F	forward voltage	$I_F = 1\text{ A}$; see Figs 14 and 15	–	–	2.50	V				
	BYV26A to E BYV26F and G				2.15	V				
$V_{(BR)R}$	reverse avalanche breakdown voltage	$I_R = 0.1\text{ mA}$								
	BYV26A						300	–	–	V
	BYV26B						500	–	–	V
	BYV26C						700	–	–	V
	BYV26D						900	–	–	V
	BYV26E						1100	–	–	V
	BYV26F BYV26G						1300 1500	–	–	V V
I_R	reverse current	$V_R = V_{RRM\text{ max}}$; see Fig.16	–	–	5	μA				
		$V_R = V_{RRM\text{ max}}$; $T_j = 165\text{ °C}$; see Fig.16	–	–	150	μA				
t_{rr}	reverse recovery time	when switched from $I_F = 0.5\text{ A}$ to $I_R = 1\text{ A}$; measured at $I_R = 0.25\text{ A}$; see Fig.20	–	–	30	ns				
	BYV26A to C BYV26D and E				75	ns				
	BYV26F and G				150	ns				
C_d	diode capacitance	$f = 1\text{ MHz}$; $V_R = 0\text{ V}$; see Figs 17 and 18	–	45	–	pF				
	BYV26A to C BYV26D and E			40	–	pF pF				
	BYV26F and G			35	–	pF				

Fast soft-recovery controlled avalanche rectifiers

BYV26 series

SYMBOL	PARAMETER	CONDITIONS	MIN.	TYP.	MAX.	UNIT
$\left \frac{dI_R}{dt} \right $	maximum slope of reverse recovery current	when switched from $I_F = 1$ A to $V_R \geq 30$ V and $dI_F/dt = -1$ A/ μ s; see Fig.21				
	BYV26A to C		–	–	7	A/ μ s
	BYV26D and E		–	–	6	A/ μ s
	BYV26F and G		–	–	5	A/ μ s

THERMAL CHARACTERISTICS

SYMBOL	PARAMETER	CONDITIONS	VALUE	UNIT
$R_{th\ j-tp}$	thermal resistance from junction to tie-point	lead length = 10 mm	46	K/W
$R_{th\ j-a}$	thermal resistance from junction to ambient	note 1	100	K/W

Note

1. Device mounted on an epoxy-glass printed-circuit board, 1.5 mm thick; thickness of Cu-layer ≥ 40 μ m, see Fig.19. For more information please refer to the "General Part of associated Handbook".

Fast soft-recovery
controlled avalanche rectifiers

BYV26 series

GRAPHICAL DATA

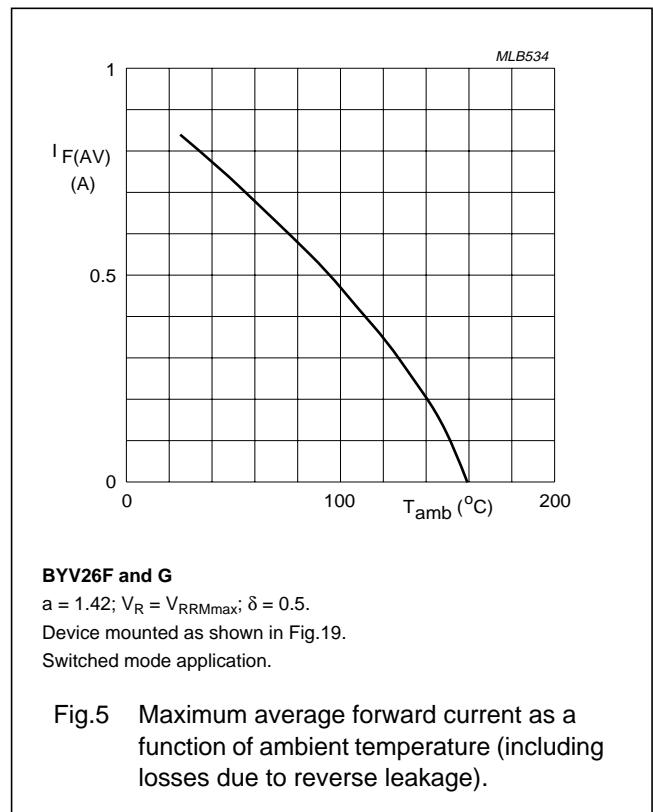
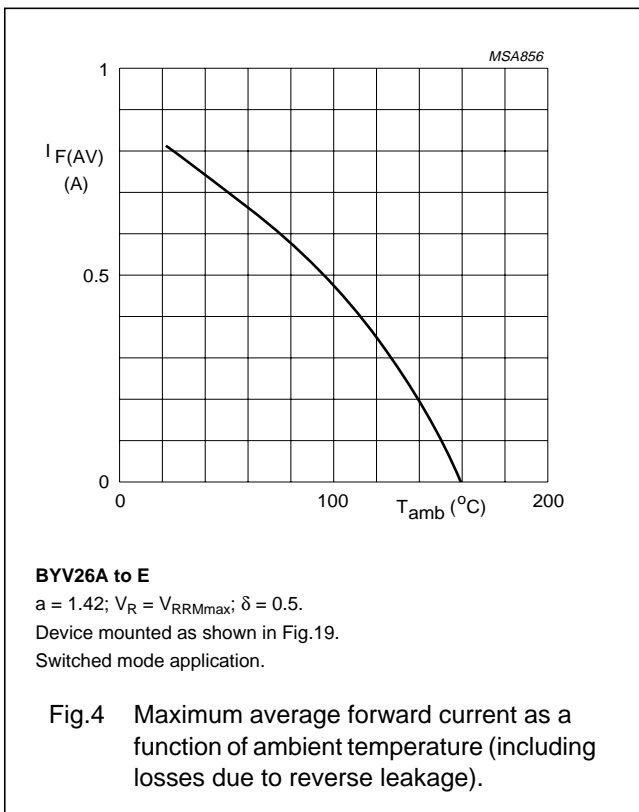
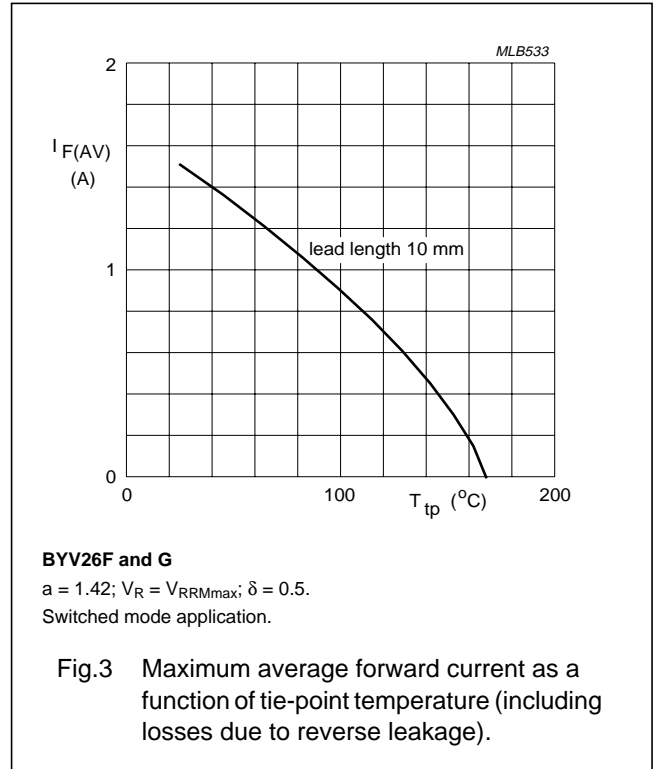
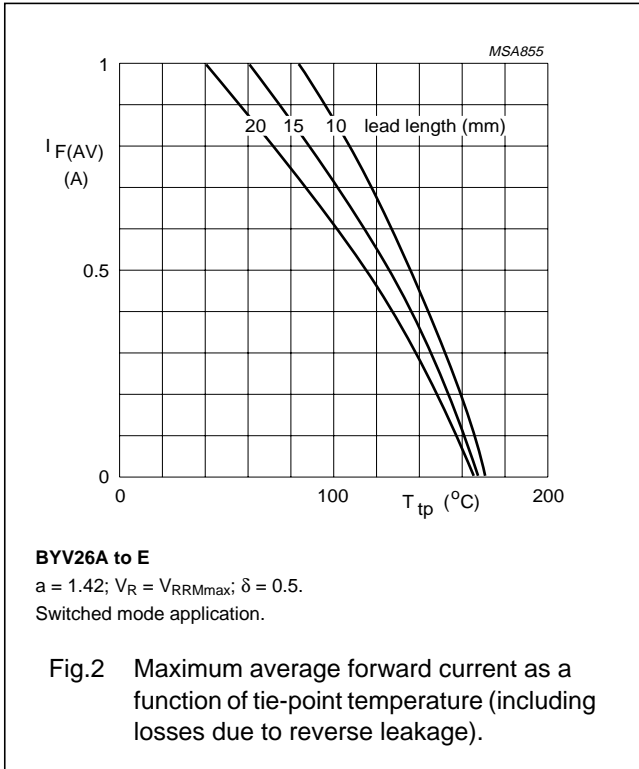

Fast soft-recovery
controlled avalanche rectifiers

BYV26 series

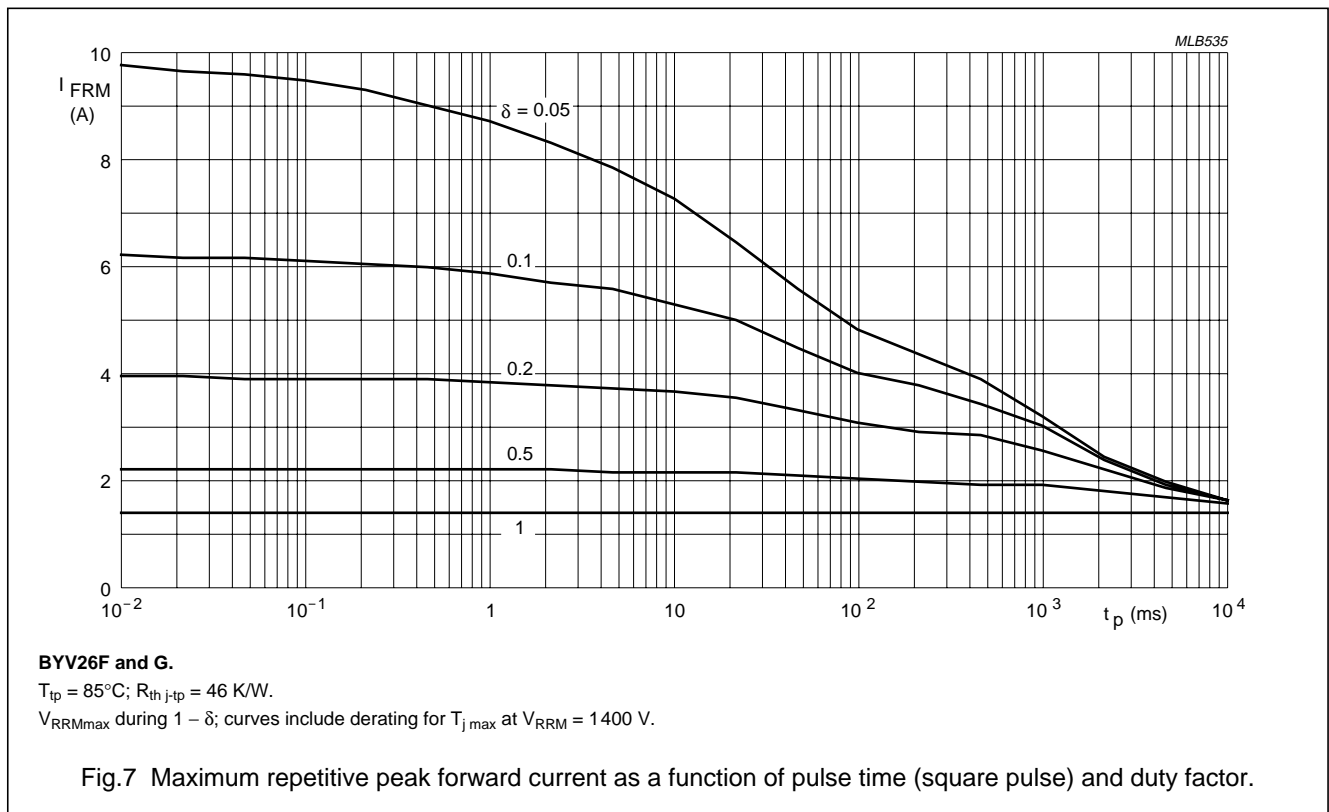
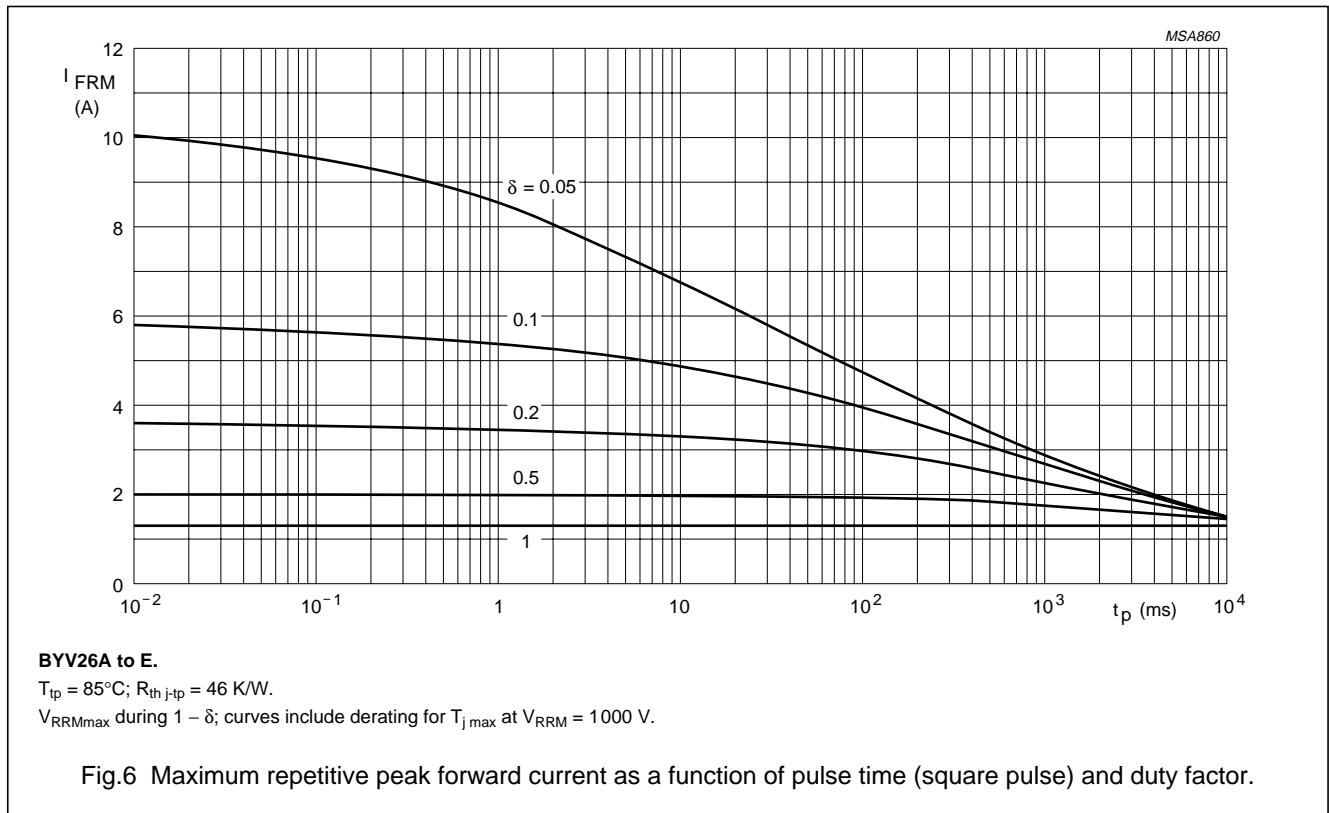

Fast soft-recovery
controlled avalanche rectifiers

BYV26 series

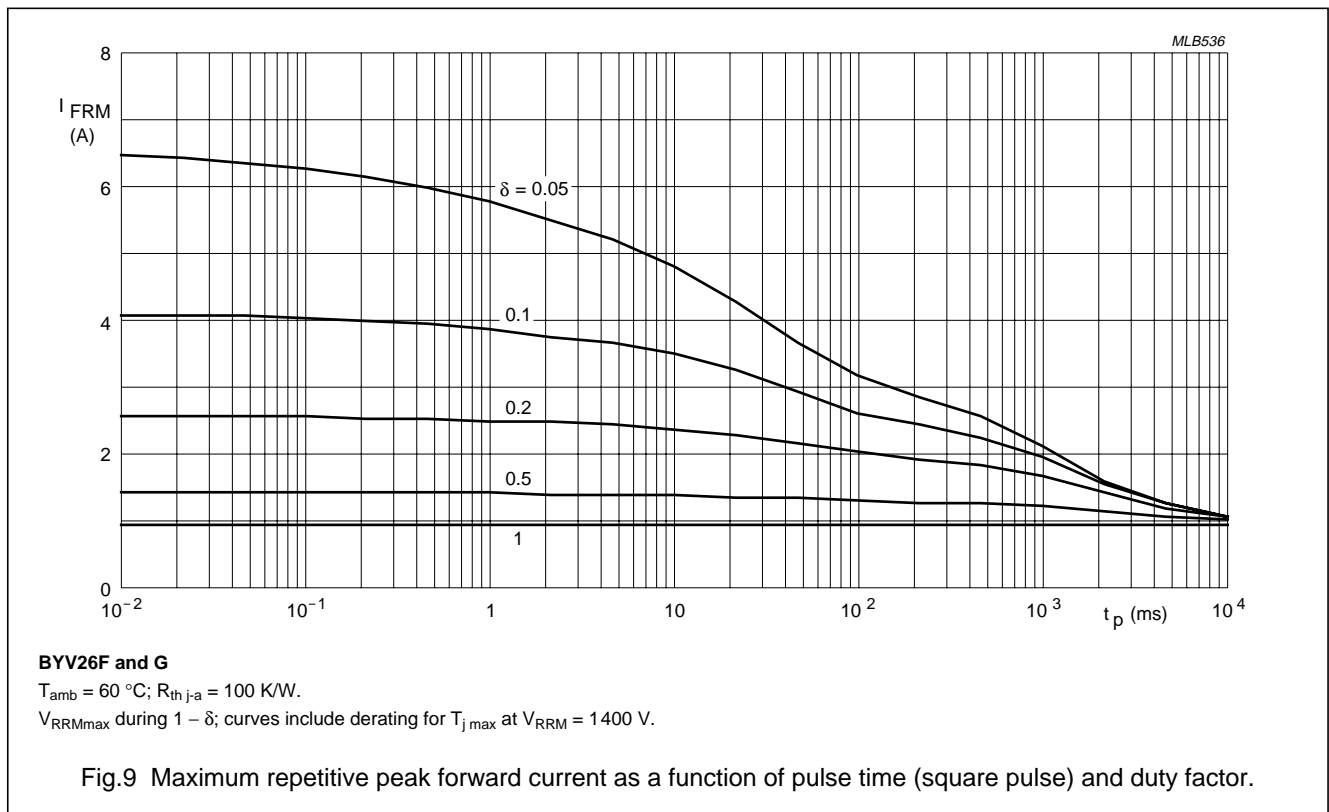
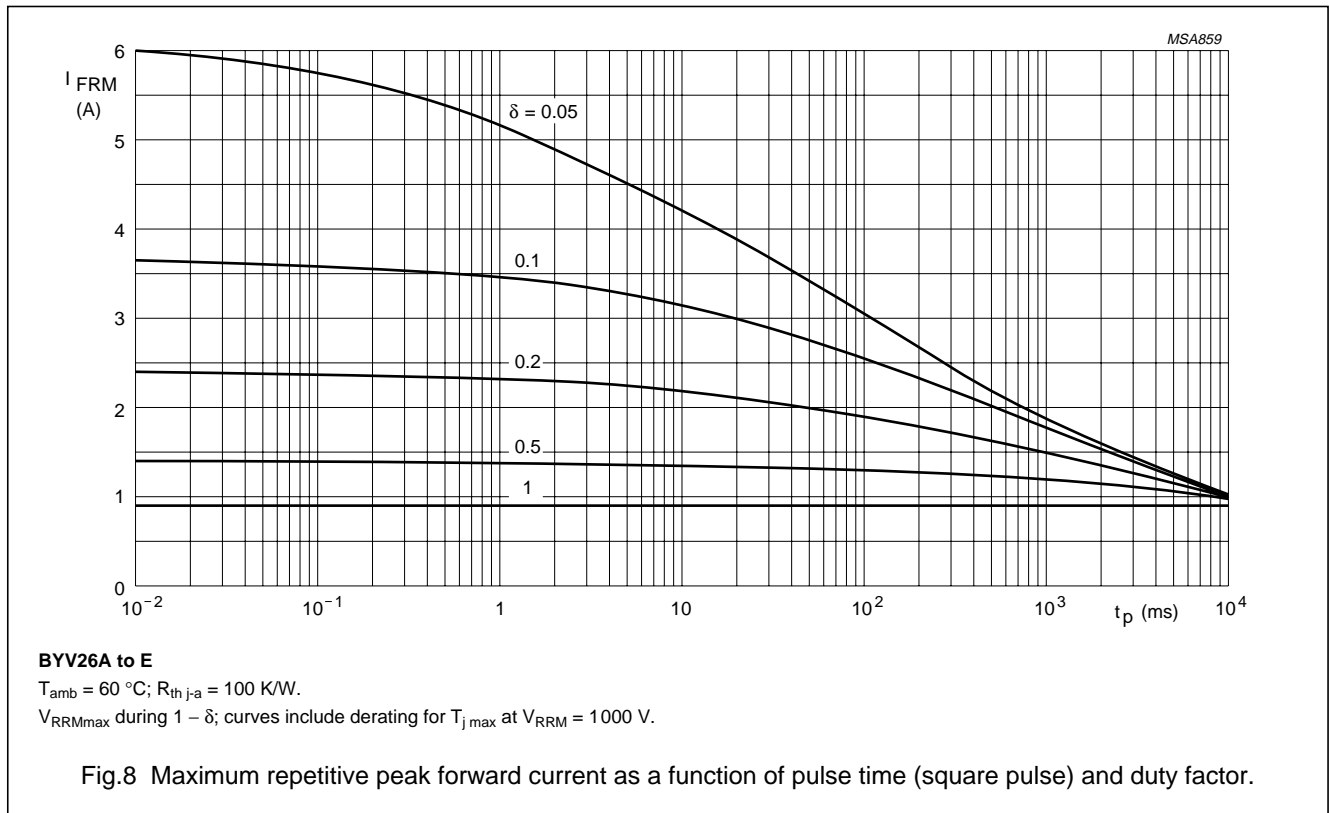

Fast soft-recovery
controlled avalanche rectifiers

BYV26 series

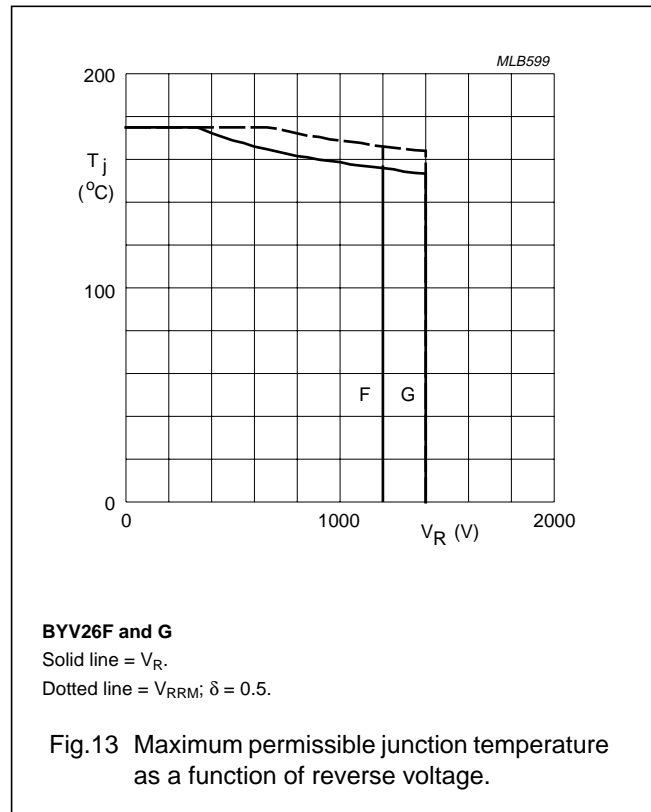
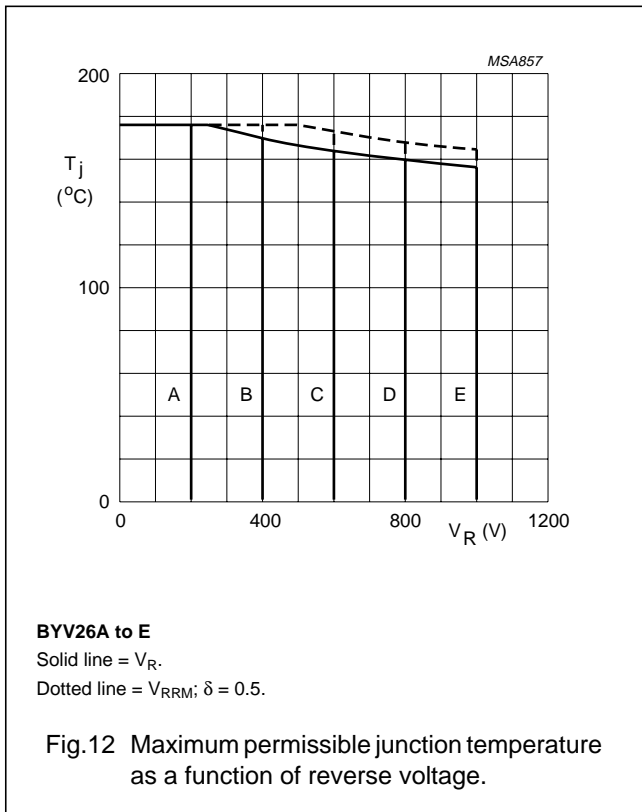
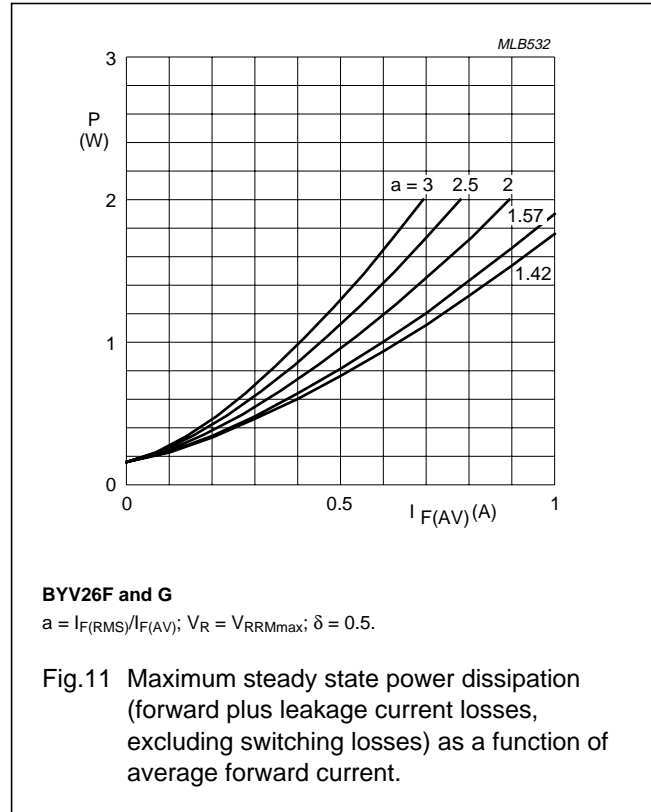
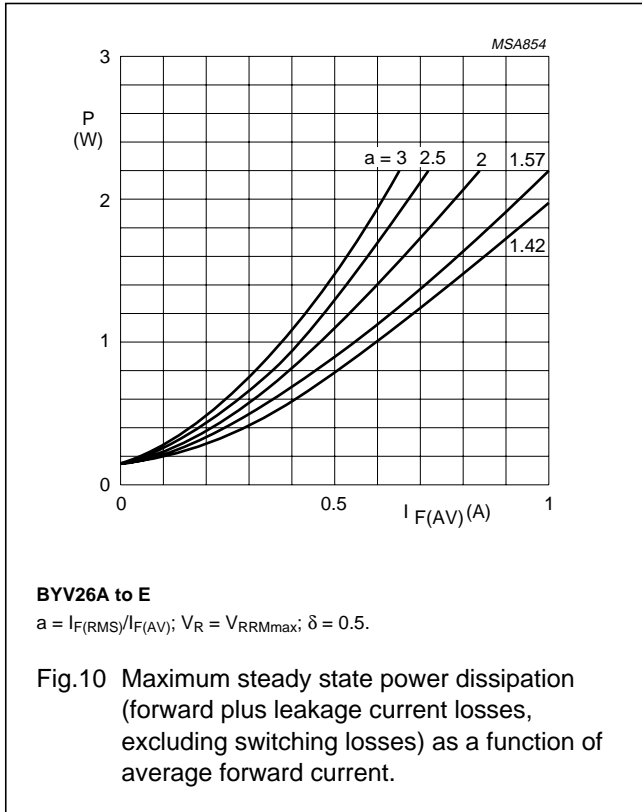

Fast soft-recovery
controlled avalanche rectifiers

BYV26 series

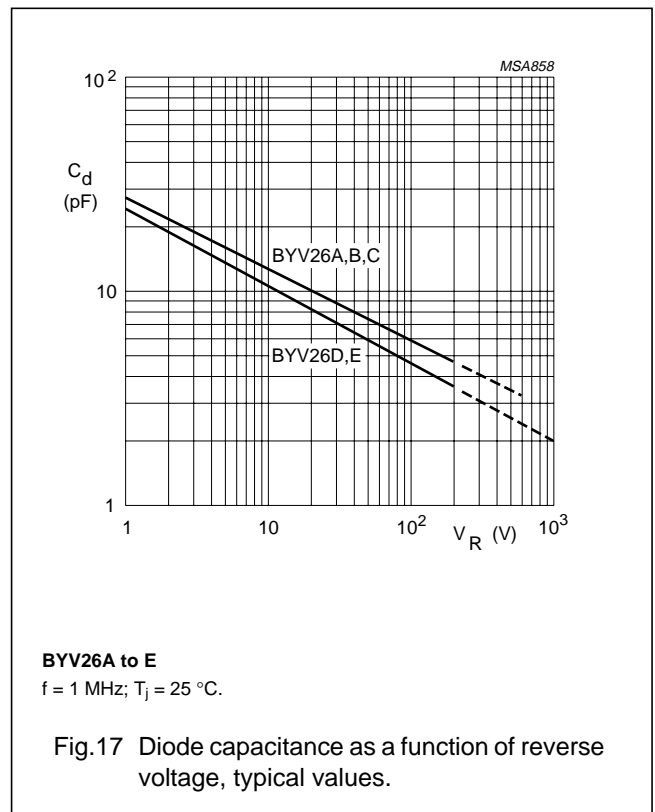
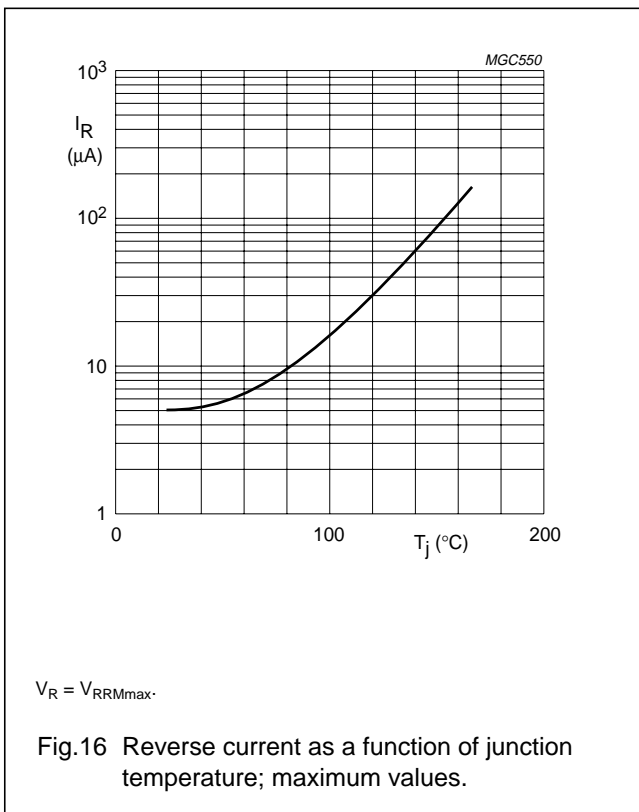
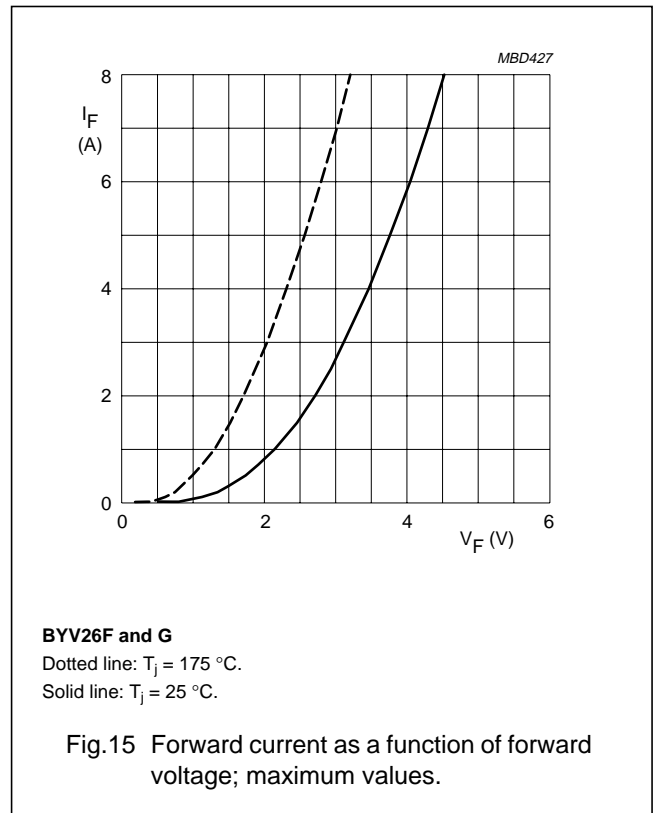
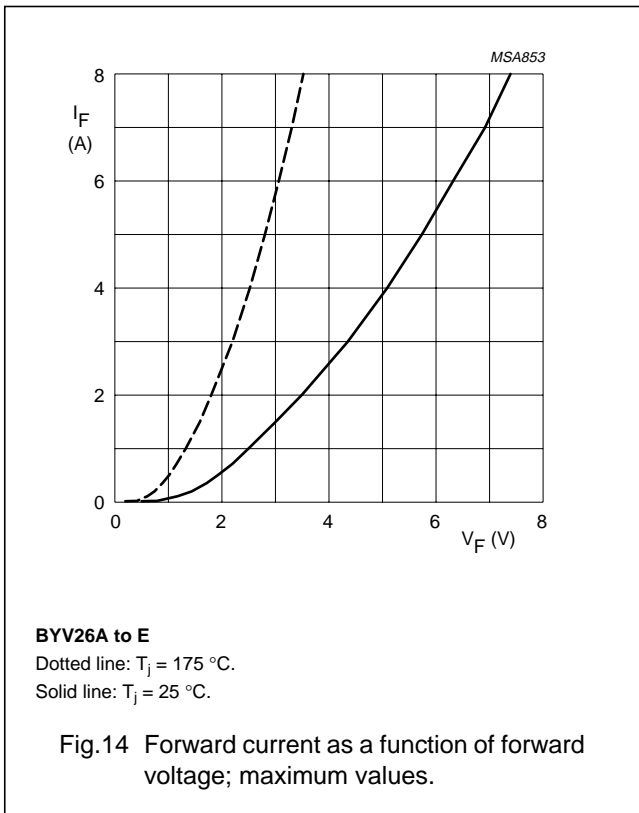

Fast soft-recovery controlled avalanche rectifiers

BYV26 series

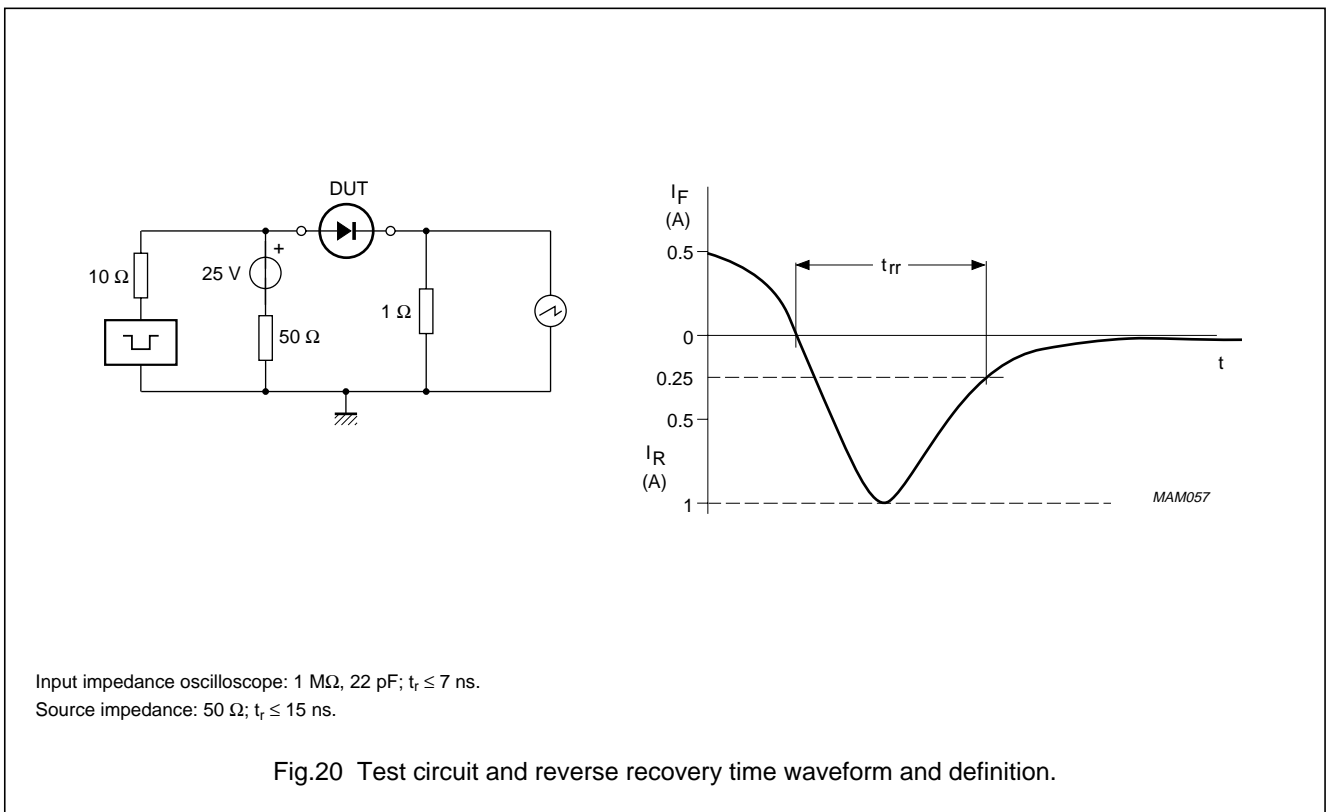
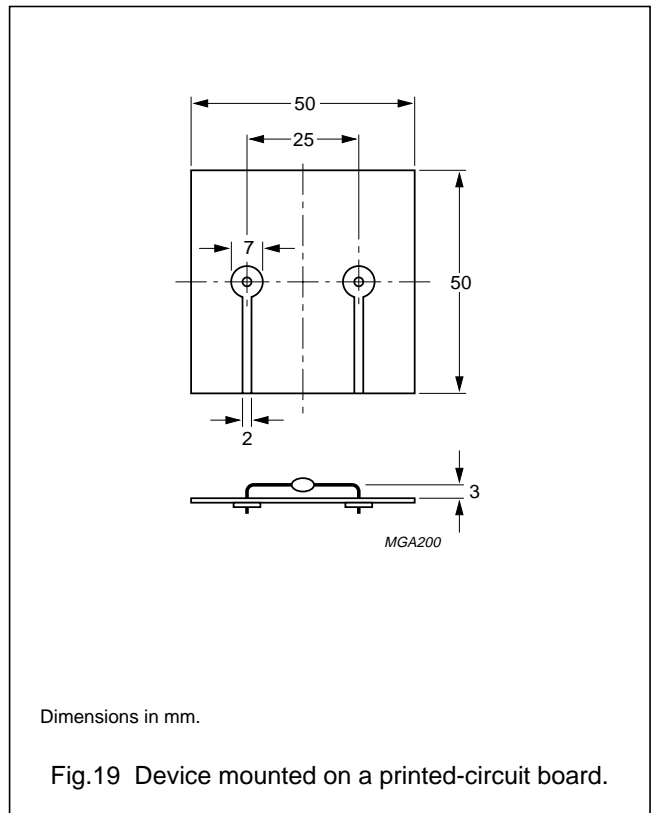
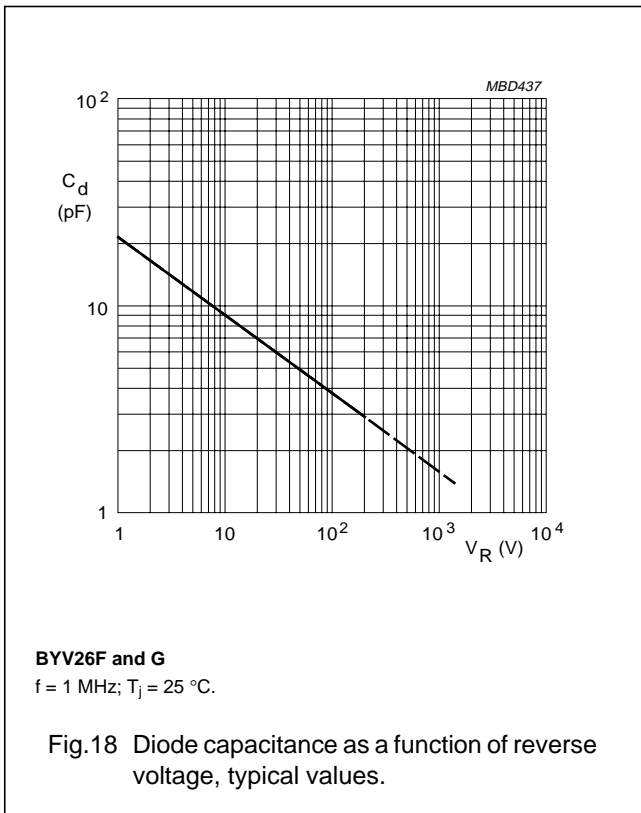

Fast soft-recovery
controlled avalanche rectifiers

BYV26 series

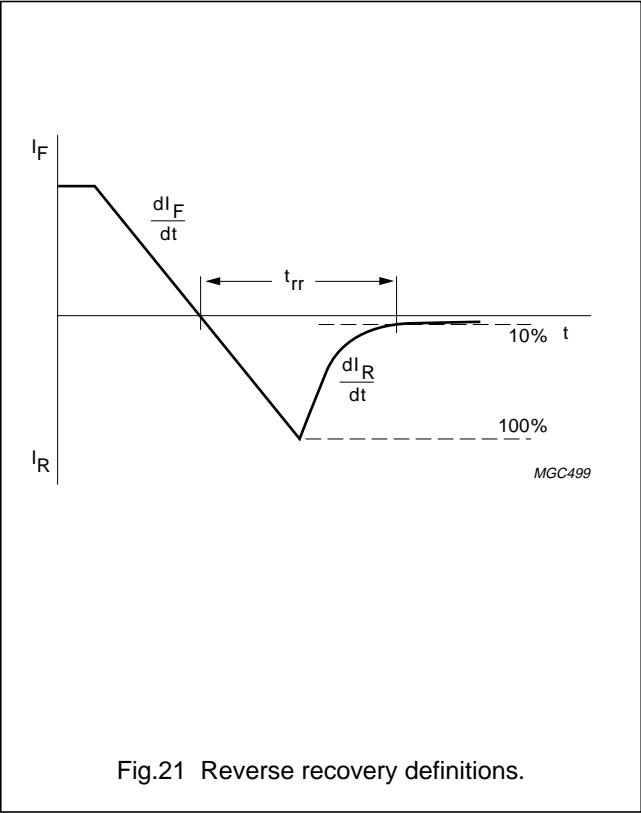
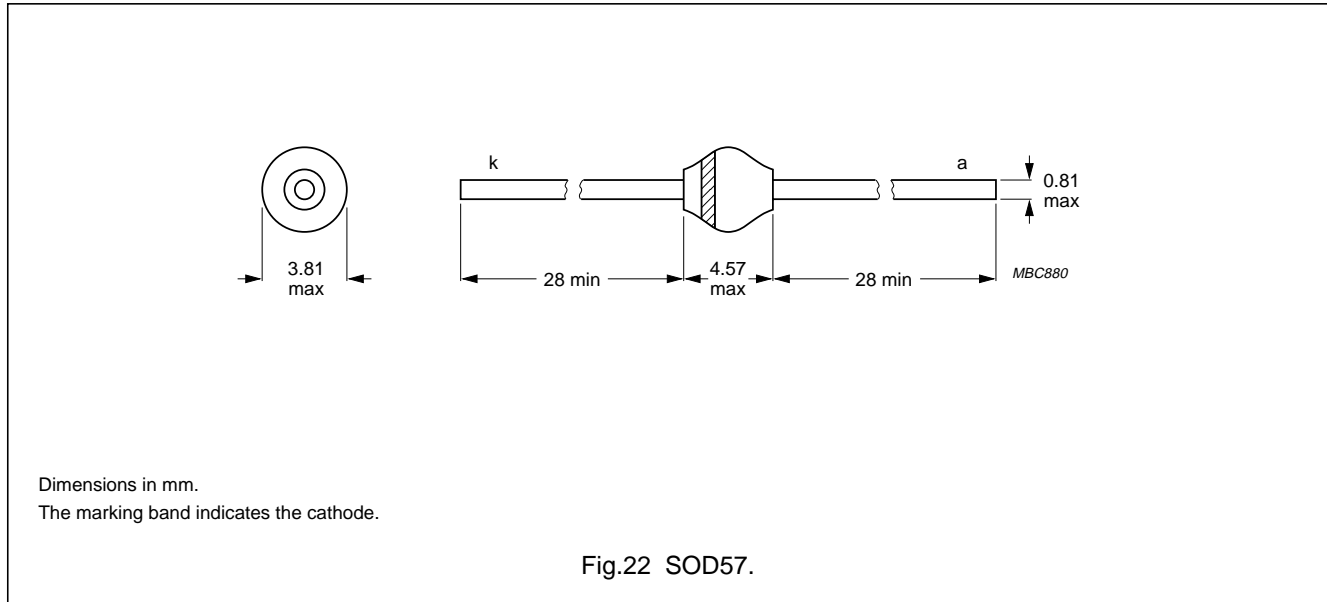

Fig.21 Reverse recovery definitions.

Fast soft-recovery
controlled avalanche rectifiers

BYV26 series

PACKAGE OUTLINE



DEFINITIONS

Data Sheet Status	
Objective specification	This data sheet contains target or goal specifications for product development.
Preliminary specification	This data sheet contains preliminary data; supplementary data may be published later.
Product specification	This data sheet contains final product specifications.
Limiting values	
Limiting values given are in accordance with the Absolute Maximum Rating System (IEC 134). Stress above one or more of the limiting values may cause permanent damage to the device. These are stress ratings only and operation of the device at these or at any other conditions above those given in the Characteristics sections of the specification is not implied. Exposure to limiting values for extended periods may affect device reliability.	
Application information	
Where application information is given, it is advisory and does not form part of the specification.	

LIFE SUPPORT APPLICATIONS

These products are not designed for use in life support appliances, devices, or systems where malfunction of these products can reasonably be expected to result in personal injury. Philips customers using or selling these products for use in such applications do so at their own risk and agree to fully indemnify Philips for any damages resulting from such improper use or sale.