

DIP SWITCH D(M)(J)(L) SERIES

SMT Type

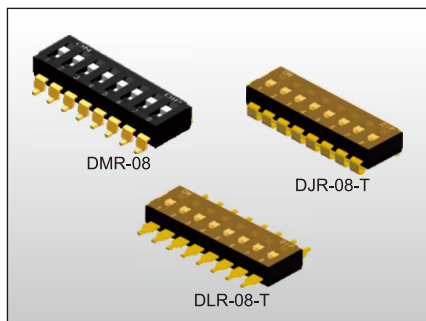

FEATURES

- ※ Low profile for space saving
- ※ Gold contact for high reliability
- ※ Top tape type for washing process

APPLICATION

- ※ Industrial control
- ※ Automatic machines control
- ※ Telecommunication

SPECIFICATION

Contact Rating	25mA, 24V DC
Contact Resistance	50mΩ max.
Insulation Resistance	100MΩ min. 500V DC
Dielectric Strength	500V AC/1 minute
Operating Force	1,000gf max.
Travel	1mm
Operating Life	2,000 cycles
Operating Temp.	-20°C ~ +85°C
Storage Temp.	-40°C ~ +85°C

HOW TO ORDER

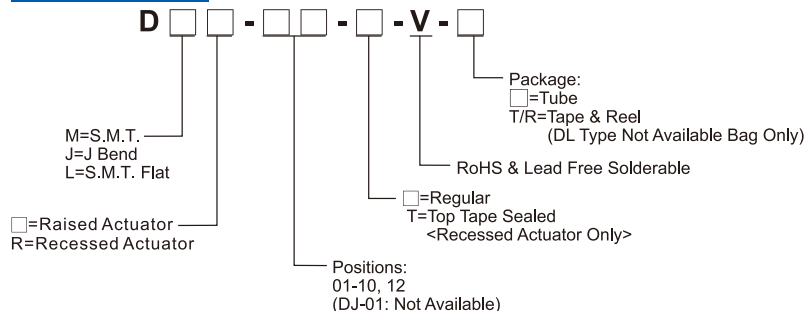

CIRCUIT

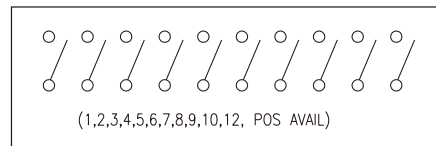

PACKAGE

<Tube>
 DM(R), DJ(R):
 01: 130 pcs 02: 76 pcs 03: 55 pcs 04: 42 pcs
 05: 35 pcs 06: 28 pcs 07: 25 pcs 08: 22 pcs
 09: 20 pcs 10: 18 pcs 12: 15 pcs

<Tape & Reel>
 DM(R)-01: 800 pcs
 DMR-02~DMR-12: 900 pcs
 DM-(01)(05)(07): 800 pcs
 DM-(02)(03)(04)(06)(08)(09)(10)(12): 700 pcs
 DJR-(02)(03)(04)(08)(09)(10): 1000 pcs

<Bag>
 DL(R): 1000 pcs

DM(R)

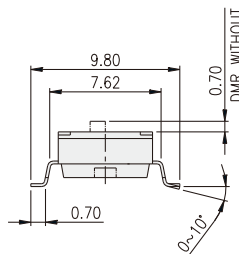
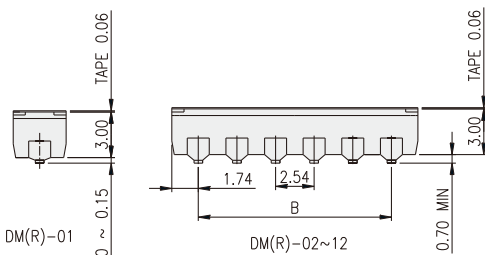
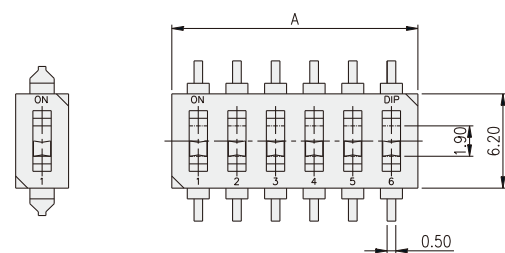

PART NO.	NO.OF POS.	DIM.A	DIM.B
DM(R)-01	1	3.48	
DM(R)-02	2	6.02	2.54
DM(R)-03	3	8.56	5.08
DM(R)-04	4	11.10	7.62
DM(R)-05	5	13.64	10.16
DM(R)-06	6	16.18	12.70
DM(R)-07	7	18.72	15.24
DM(R)-08	8	21.26	17.78
DM(R)-09	9	23.80	20.32
DM(R)-10	10	26.34	22.86
DM(R)-12	12	31.42	27.94

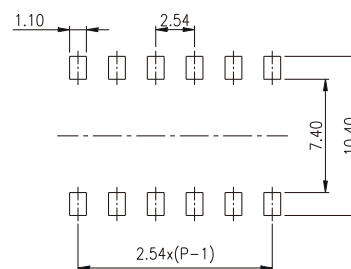

P.C.B. LAYOUT

DIP SWITCH

DJ(R)

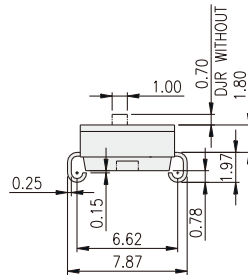
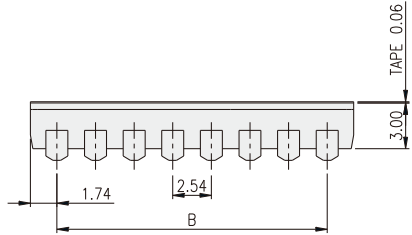
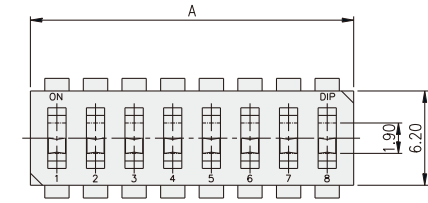

PART NO.	NO.OF POS.	DIM.A	DIM.B
DJ(R)-02	2	6.02	2.54
DJ(R)-03	3	8.56	5.08
DJ(R)-04	4	11.10	7.62
DJ(R)-05	5	13.64	10.16
DJ(R)-06	6	16.18	12.70
DJ(R)-07	7	18.72	15.24
DJ(R)-08	8	21.26	17.78
DJ(R)-09	9	23.80	20.32
DJ(R)-10	10	26.34	22.86
DJ(R)-12	12	31.42	27.94

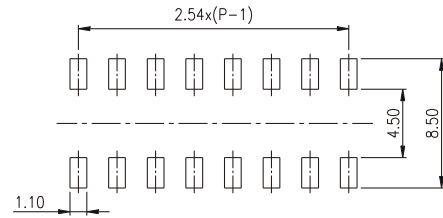

P.C.B. LAYOUT

DL(R)

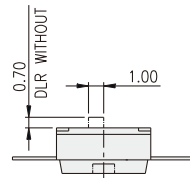
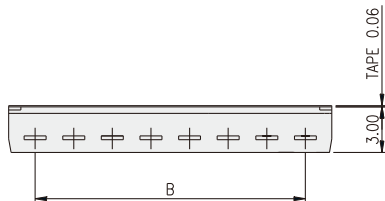
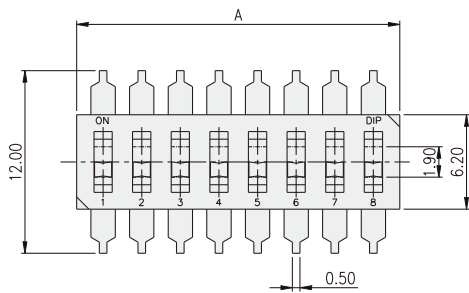

PART NO.	NO.OF POS.	DIM.A	DIM.B
DL(R)-01	1	3.48	/
DL(R)-02	2	6.02	2.54
DL(R)-03	3	8.56	5.08
DL(R)-04	4	11.10	7.62
DL(R)-05	5	13.64	10.16
DL(R)-06	6	16.18	12.70
DL(R)-07	7	18.72	15.24
DL(R)-08	8	21.26	17.78
DL(R)-09	9	23.80	20.32
DL(R)-10	10	26.34	22.86
DL(R)-12	12	31.42	27.94

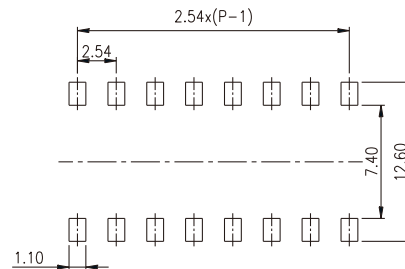

P.C.B. LAYOUT

DIP SWITCH