

Search by product line or name, SKU or product feature



Toggle between single and double page views based on your preference



Download individual pages or page ranges to share or save



Add notes throughout the catalog to keep track of comments, questions, and product options



Send individual catalog pages directly to mail in-boxes or post on LinkedIn with a single click



Crop images or specific pieces of information to share, download or print



View page thumbnails for faster access to specific product sectors



Create a wish list within the catalog that can be revisited at any time



Use the arrows, bookmarks or table of contents tab to make navigation a breeze



CMC® OEM Products

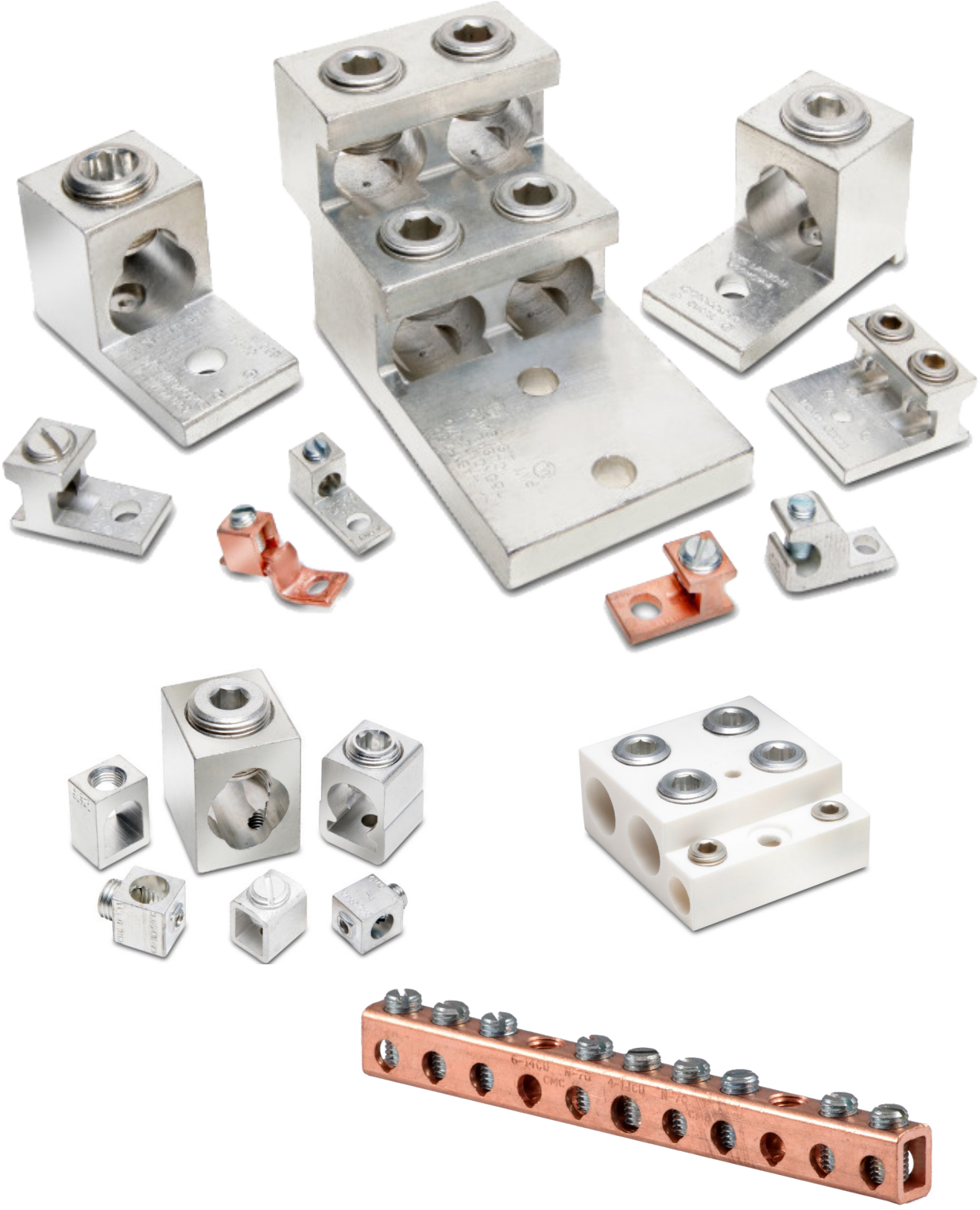

Connecting Power to Your World

CMC® OEM Products

Solutions to Support Original Equipment Manufacturers

Continuous Innovation for the OEM Market

For more than 70 years, Connector Manufacturing Company (CMC®) has been dedicated to engineering, designing and manufacturing quality products for the OEM industry. Thanks to this long history, CMC® has a solid understanding of industry challenges and provides the flexibility and expertise to provide solutions that:

- Improve reliability
- Increase efficiency
- Reduce acquisition and operational costs

Tap our knowledge and you'll benefit from our wide-reaching capabilities, such as:

- Complete in-house engineering and design
- A certified UL third-party test facility equipped to perform UL, ANSI and CSA test requirements
- Customer service that consistently provides knowledgeable answers to our distributors and end-users

As a result, CMC® provides competitively priced connector and neutral bar solutions that minimize installation time while ensuring the highest level of quality and safety.

Surpassing Industry Standards

Headquartered in Ohio, CMC® is home to one of the industry's most comprehensive third-party testing facilities in the United States. The CMC® lab is qualified under the ISO Guide 17025-2008 certification requirements for lab accreditation. We have teams of lab technicians at multiple lab facilities to perform tests that include:

- Electrical (current cycle, fault current, static heat)
- Mechanical (sustained load, pullout, secureness, fatigue)
- Environmental (freeze/thaw, salt spray)
- Metallurgical (grain structure, heat treatment, failure analysis)

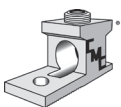

CONNECTOR
MANUFACTURING
COMPANY

www.cmclugs.com

513.860.4455

Custom Connectors

Thanks to our long history, CMC® has a solid understanding of industry challenges. We offer a dedicated and specialized engineering team, masterful in the ability to work with customers from all markets to design, fabricate, and deliver CUSTOMIZED connectors and SOLUTIONS for your specific applications. WE'VE GOT YOU!

Here are some examples:

Special Inside-Mounted Connectors

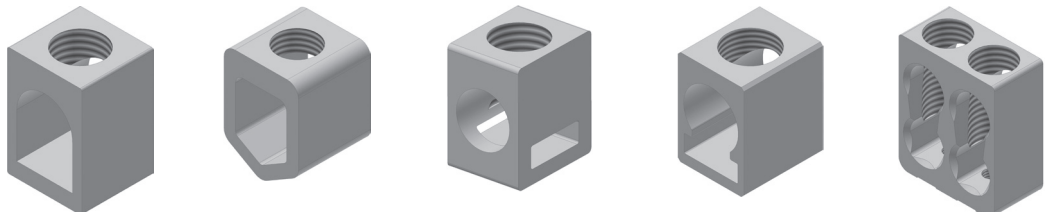

Special Top-Mounted Connectors

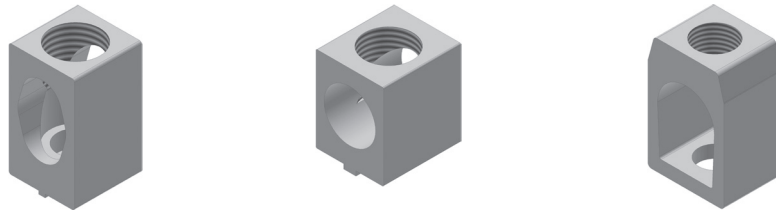

Special Styles

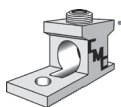
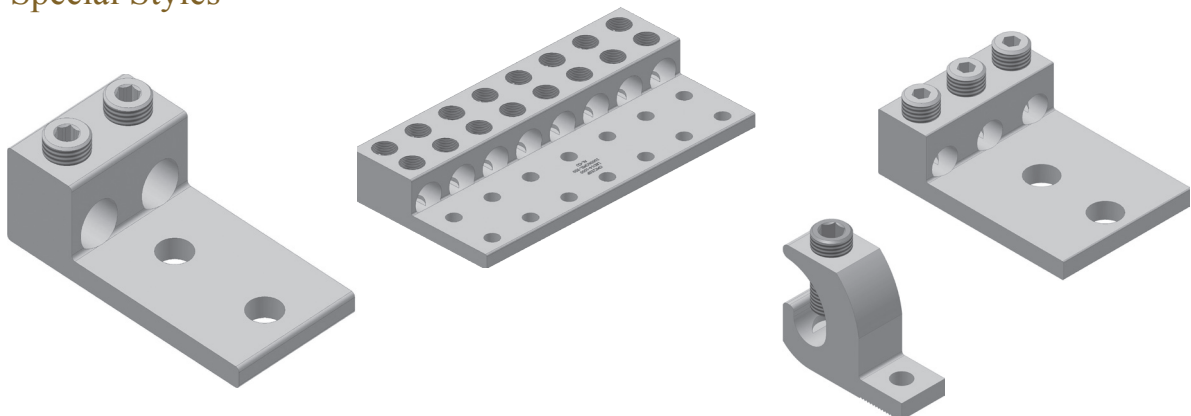

**CONNECTOR
MANUFACTURING
COMPANY**

www.cmclugs.com

513.860.4455

Aluminum Dual Rated Mechanical Connectors

A new generation in mechanical connector performance.

Cool running over 500 heat cycles. Versatile, simple to use and low cost.



PosiGrip®



Introduction

CMC® introduces PosiGrip® aluminum dual-rated mechanical connectors. The PosiGrip® line is designed to meet the rigorous requirements of 486B and CSA 1165A specifications covering connectors for use with aluminum and copper conductors. The PosiGrip® line is fully listed by Underwriters Laboratories, Inc. and Canadian Standards Association. In addition, these connectors are EU RoHS compliant.

Low Resistance Design

Low initial contact resistance is the key to long life for any electrical connection and is the major element in meeting the demanding performance requirements of UL 486B. Connector Manufacturing Company's engineers have incorporated special new design concepts into the PosiGrip® line. Uniquely designed I-Beam bodies and conductor hole configuration along with specially designed and treated screws; minimize high resistance connector failures due to thermal expansion, creep, and insufficient clamping force. The superior gripping action of the I-Beam design allows the set screw to separate conductor strands and break down inner stand oxidation even on compressed and compact aluminum conductors. Therefore, superior performance and long connector life are assured regardless of the type of conductor being used.

Versatility

Each PosiGrip® connector will accommodate a wide range of aluminum or copper conductor sizes of concentric, compressed or compact configurations. Only eleven connector sizes cover the range from #14 thru 1000 kcmil. In addition, they are UL listed and CSA certified for use with conductors having thermal insulation ratings of 90°C or less. This means greater flexibility in the type of conductor being used, less inventory to carry and fewer call backs because the installer doesn't have the right part. Easy to install; all you need is a screwdriver or an allen wrench.

Quality Assurance

To identify UL 486B connectors, UL requires such connectors to be marked CU9AL when listed for use with 90° C rated conductors. To be sure that the connector you buy meets all UL requirements, CMC® inspects each lot of PosiGrip® connectors for integrity of physical dimensions, aluminum properties, set screw and conductor hole alignment, plating, along with screw and body thread class. Only connector lots meeting industry accepted quality levels are approved for shipment.

PosiGrip® Lug Features

1. The unique ridges formed on the bottom of the contact surface are designed to provide positive contact points for an electrically secure joint of the lowest resistance for current flow. Just as a tri-pod provides tilt free contact on a smooth surface, this connector is designed to cause specific contact points where current can flow without "hot spots" created when two flat surfaces are joined together.
2. The screws used to clamp the conductor are designed to extend beyond the barrel sides of the connector to allow a better, more secure compression of the conductor. This design spreads conductor strands to help dissipate heat. In addition, this causes the maximum conductor to spread slightly more than the wire way opening which when installed improves its pull out safety features and capabilities.
3. The design of the wire way opening allows the conductor to enter the lug at the lowest point possible near the tang of the lug to provide optimum transfer of current creating a straight line flow through the connector for the least possible path of electrical resistance. A positive wire stop is provided with a step in the connector tang.

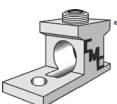

**CONNECTOR
MANUFACTURING
COMPANY**

www.cmclugs.com

513.860.4455

PosiGrip®

A NEW, IMPROVED PATENTED LUG DESIGN

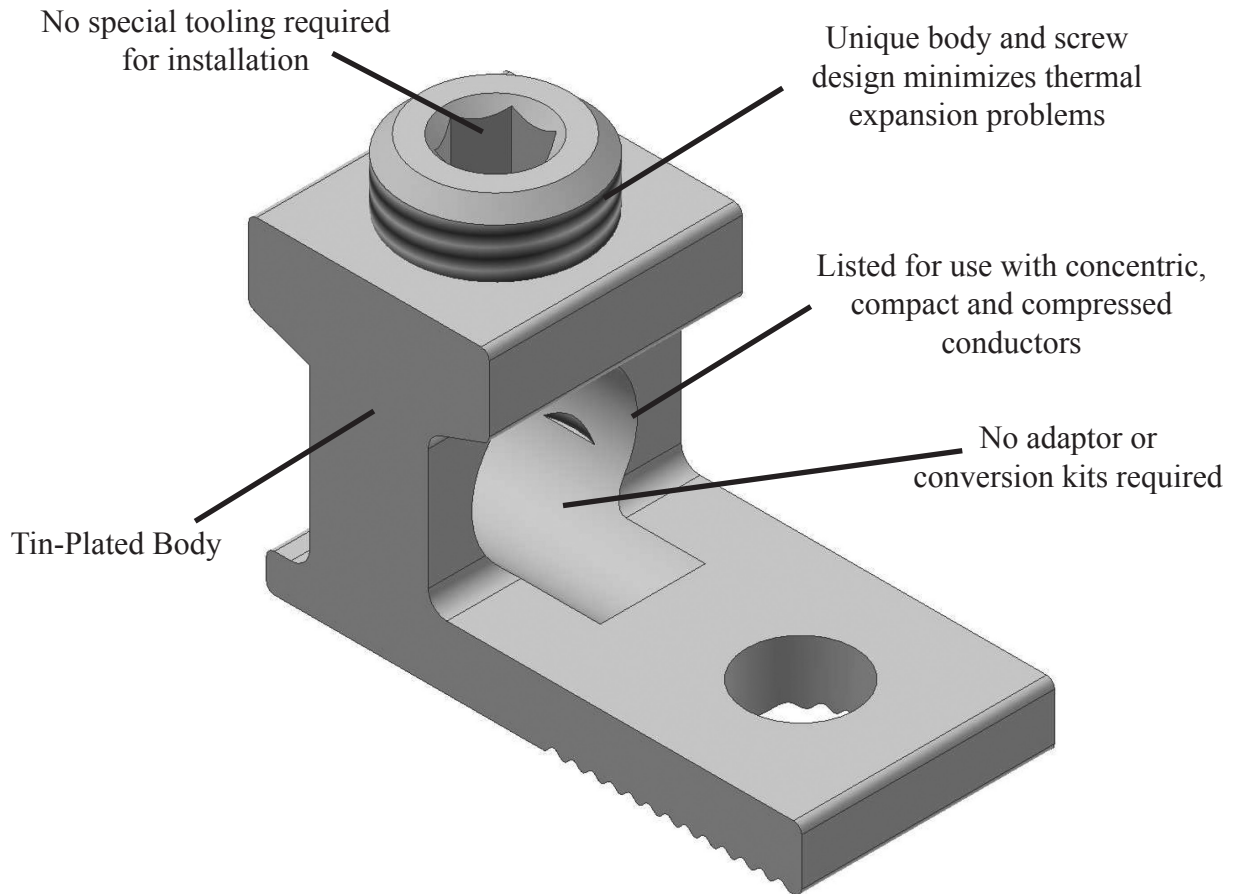

New generation of UL-486B Listed CSA Certified 90° C Rated Connectors

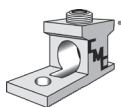



**CONNECTOR
MANUFACTURING
COMPANY**

www.cmclugs.com

513.860.4455

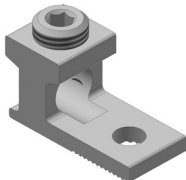
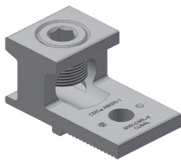
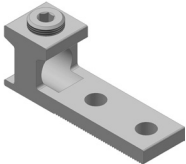
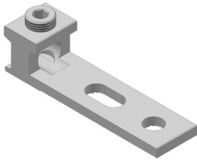
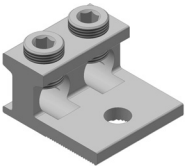
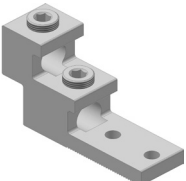
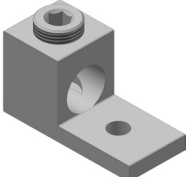
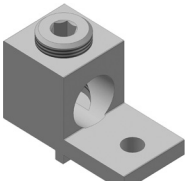
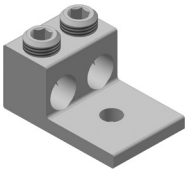
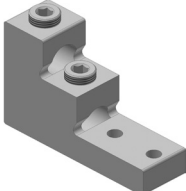
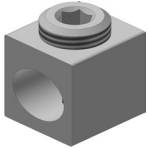
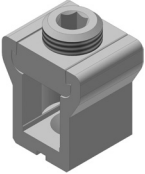
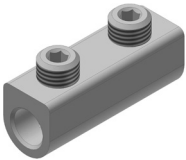
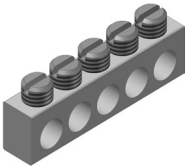
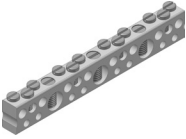
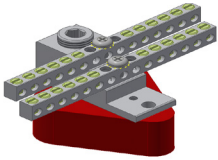
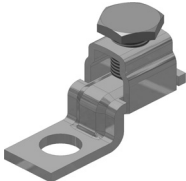
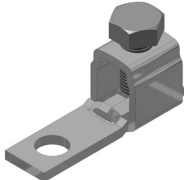
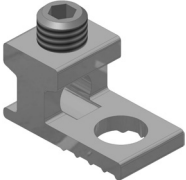
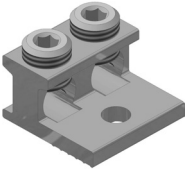
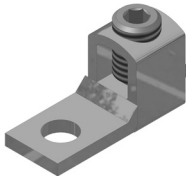
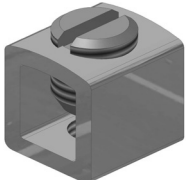
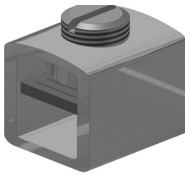
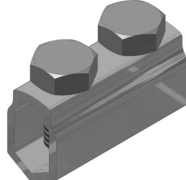
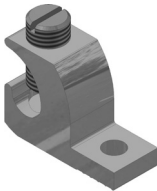
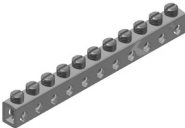
Pictorial Index

<p>AB</p> 	<p>AB Anti-Turn</p> 	<p>A1B2</p> 	<p>ABSG</p> 	<p>2AB</p> 
<p>ABV</p> 	<p>LA</p> 	<p>LA Anti-Turn</p> 	<p>DLA</p> 	<p>PV</p> 
<p>CA</p> 	<p>LI</p> 	<p>SR</p> 	<p>NA</p> 	<p>SCB</p> 
<p>SNB-350</p> 	<p>CF</p> 	<p>CFS</p> 	<p>BC</p> 	<p>2BC</p> 
<p>FT</p> 	<p>C</p> 	<p>CS</p> 	<p>C2/C4</p> 	<p>CL</p> 
<p>N70</p> 	<p>LCB</p> 			

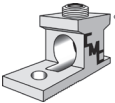

CMC® Aluminum Connectors

CMC® is proud to supply the industry with a line of electrical connectors fabricated from the very best aluminum alloy, 6061-T6. This choice was predicated upon many design factors to achieve the best balance between strength and conductivity. Both factors are of extreme importance in connector design calculations. The aluminum extrusions have almost a two-to-one advantage in yield strength to that of a sand cast alloy 356 or die cast alloy AXS679, permitting an extra margin of safety while the conductivity is a most favorable 43% IACS.

The set and socket screw mechanical connectors are designed to utilize the advantages of the 6061-T6 alloy temper for high yield strength while providing a connector of low stress. Screw pressure is designed to break through aluminum conductor oxide by cold flow process that ensures a low resistance connection. Sufficient pressure is maintained on the conductor to prevent the reforming of the aluminum oxide. The pressure, combined with the high conductivity factor, will result in a connector operating temperature below that of the conductor.

We therefore, offer these advantages in connector design:

1. Compact design
2. High strength aluminum
3. Relative light weight construction
4. Economic
5. Tested products in accordance with the Underwriters Laboratories and the Canadian Standards Association requirements for listing.

These factors together with our dedication for the highest quality standards available and an unsurpassed service level, provide our customers with maximum reliability.



Single Conductor Solderless Lugs

TYPE: AB

Features

- Made of 6061-T6 Aluminum Alloy
- Electro-Tin Plated
- Patented PosiGrip® Design
- Positive Wire Stop
- Dual-Rated

Benefits

- Easy Installation
- Improved Pull-Out and Safety Features

Custom configurations available upon request.

Catalog Number	Fig	Screw	Stud Size* mm	Cond. Range mm ²	H	W	L	G	T
					Dimensions - inches				
					Dimensions - millimeters				
AB-50-S	1	Slot	1/4	6-14	.49	.5	1.06	.31	.09
			6.35	16-1.5	12.45	12.70	26.92	7.87	2.29
AB-70-S	1	Slot	1/4	2-14	.55	.50	1.16	.31	.10
			6.35	25-1.5	13.97	12.70	29.46	7.87	2.54
AB-112S	1	Slot or Hex	1/4	1/0-14	.78	.62	1.31	.31	.16
			6.35	50-1.5	19.81	15.75	33.27	7.87	4.06
AB-125S	1	Slot or Hex	1/4	2/0-14	.78	.63	1.47	.38	.19
			6.35	50-1.5	19.81	16.00	37.34	9.65	4.83
AB-250S	2	0.31H	5/16	250-6	1.09	.88	2.00	.44	.22
			7.87	7.94	120-16	27.69	22.35	50.80	11.18
AB-300S	2	.31H	3/8	300-6	1.13	1.00	2.00	.50	.25
			7.87	9.53	150-16	28.70	25.40	50.8	12.70
AB-350S	2	.31H	5/16	350-6	1.19	1.00	2.25	.56	.25
			7.87	7.94	185-16	30.23	25.40	57.15	14.22
AB-500S	2	.38H	3/8	500-4	1.44	1.25	2.63	.63	.31
			9.65	9.53	240-16	36.58	31.75	66.80	16.00
AB-600S	2	.38H	3/8	600-2	1.56	1.43	3.19	.88	.38
			9.65	9.53	300-25	39.62	36.32	81.03	22.35
AB-750S	2	.38H	5/8	750-1/0	1.80	1.43	3.25	.88	.44
			9.65	15.88	300-50	45.72	36.32	82.55	22.35
AB-1000S	2	.50H	1/2	1000-500	1.94	1.62	3.50	.88	.44
			12.70	12.7	500-240	49.28	41.15	88.90	22.35

*This dimension can be altered per customer requirements.

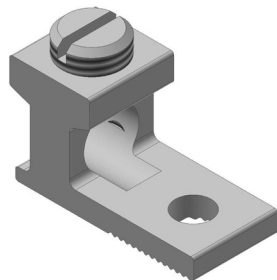

Fig.1

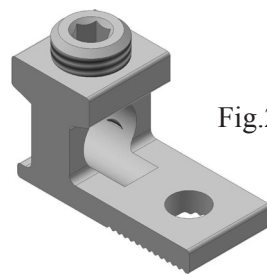
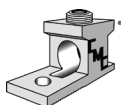

Fig.2



Single Conductor Solderless Lugs

PosiGrip®

TYPE: AB - Anti-Turn Series

90° C Rating (486B Listed)

Features

- Made of 6061-T6 Aluminum Alloy
- Electro-Tin Plated
- Patented PosiGrip® Design
- Positive Wire Stop
- Dual-Rated

Benefits

- Easy Installation
- Improved Pull-Out and Safety Features



Custom configurations available upon request.

Catalog Number	Fig	Cond. Range AWG mm ²	Stud Size* mm	H	W	L
				Dimensions - inches		
				Dimensions - millimeters		
AB-112-R	1	1/0-14	1/4	.78	.63	1.31
		50-1.5	6.35	19.81	16.00	33.27
AB-125-R	1	2/0-14	1/4	.78	.63	1.47
		50-1.5	6.35	19.81	16.00	37.34
AB-300-R	1	300-6	1/4	1.13	.88	1.78
		150-16	6.35	28.70	22.35	45.21
AB-500-1	2	500-4	3/8	1.44	1.38	2.48
		240-16	9.53	36.58	35.05	62.99
AB-600-1	2	600-2	3/8	1.56	1.38	2.75
		300-25	9.53	39.62	35.05	69.85

*This dimension can be altered per customer requirements.
Products marked “-1” use the PosiGrip® Design.

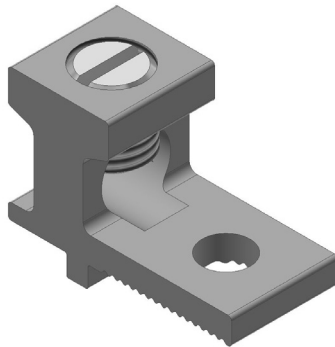

Fig.1

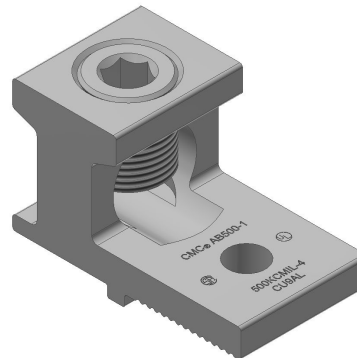
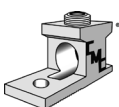

Fig.2



**CONNECTOR
MANUFACTURING
COMPANY**

www.cmclugs.com

513.860.4455

Single Conductor Solderless Lugs

PosiGrip®

TYPE: A1B2/A1B2-2

90° C Rating (486B Listed)

Features

- Made of 6061-T6 Aluminum Alloy
- Electro-Tin Plated
- Patented PosiGrip® Design
- Positive Wire Stop
- Dual-Rated

Benefits

- Easy Installation
- Improved Pull-Out and Safety Features



Custom configurations available upon request.

Catalog Number	Fig	Screw Type mm	Stud Size* mm	Cond. Range AWG mm ²	H	W	L	G	T
					Dimensions - inches				
					Dimensions - millimeters				
A1B2-350	1	.31H	1/2	350-6	1.19	1.00	4.25	.63	.25
					7.87	12.70	185-16	30.23	25.4
A1B2-500	1	.38H	1/2	500-2	1.56	1.25	4.59	.63	.38
					9.65	12.70	240-25	39.62	31.75
A1B2-600	1	.38H	1/2	600-2	1.56	1.25	4.59	.63	.38
					9.65	12.70	300-25	39.62	31.75
A1B2-750	1	.38H	1/2	750-1	1.81	1.43	4.84	.63	.44
					9.65	12.70	300-35	45.97	36.32
A1B2-1000	1	.50H	1/2	1000-500	1.94	1.63	4.94	.63	.44
					12.70	12.70	500-240	49.28	41.40
A1B2-350-2	2	.31H	1/2	350-6	1.19	1.13	5.37	.62	.25
					7.87	12.70	185-16	30.23	28.70
A1B2-500-2	2	.38H	1/2	500-4	1.56	1.50	5.62	.63	.38
					9.65	12.70	240-16	39.62	38.10
A1B2-600-2	2	.38H	1/2	600-2	1.56	1.50	5.62	.63	.38
					9.65	12.70	300-25	39.62	38.10
A1B2-750-2	2	.38H	1/2	750-300	1.94	1.50	6.19	.63	.44
					9.65	12.70	300-150	49.28	38.10
A1B2-1000-2	2	.50H	1/2	1000-500	1.94	1.63	6.19	.63	.44
					12.70	12.70	500-240	49.28	41.40

*This dimension can be altered per customer requirements.

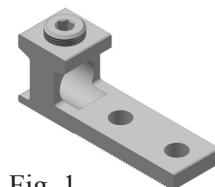
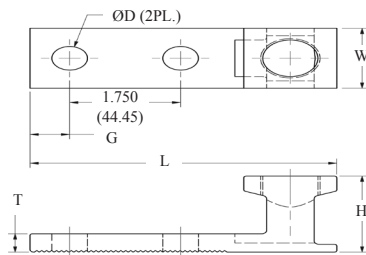

Fig. 1

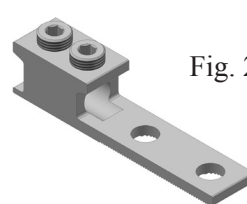

Fig. 2

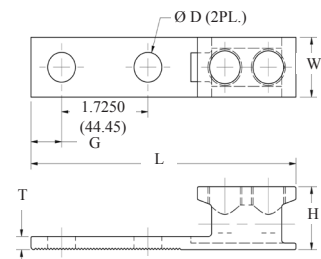
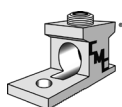

Fig. 1



**CONNECTOR
MANUFACTURING
COMPANY**

www.cmclugs.com

513.860.4455

Switchgear Connectors

TYPE: ABSG

PosiGrip®

Features

- Made of 6061-T6 Aluminum Alloy
- Electro-Tin Plated
- Patented PosiGrip® Design
- Positive Wire Stop
- Dual-Rated

Benefits

- Easy Installation
- Improved Pull-Out and Safety Features

90° C Rating (486B Listed)



Custom configurations available upon request.

Catalog Number	Fig	Screw Type mm	Stud Size* mm	Cond. Range AWG mm ²	H	W	L	G	T
					Dimensions - inches				
					Dimensions - millimeters				
ABSG-350	1	.31H	1/2	350-4	1.19	1.25	4.68	.72	.25
					7.87	12.70	118.87	18.29	6.35
ABSG-500	1	.38H	1/2	500-400	1.44	1.25	4.68	.72	.31
					9.65	12.70	118.87	18.29	7.87
ABSG-750	2	.38H	1/2	750-300	1.94	1.62	6.19	.72	.44
					9.65	12.70	157.23	18.29	11.18
ABSG-1000	2	.50H	1/2	1000-300	1.94	1.62	6.19	.72	.44
					12.70	12.70	157.23	18.29	11.18

*This dimension can be altered per customer requirements.

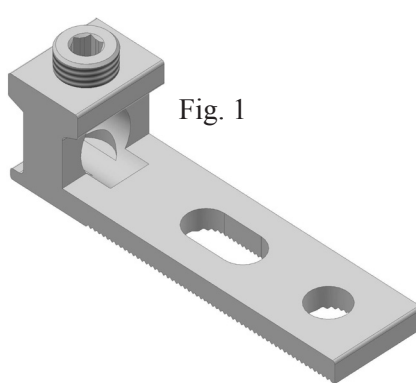

Fig. 1

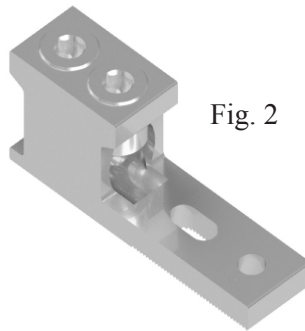
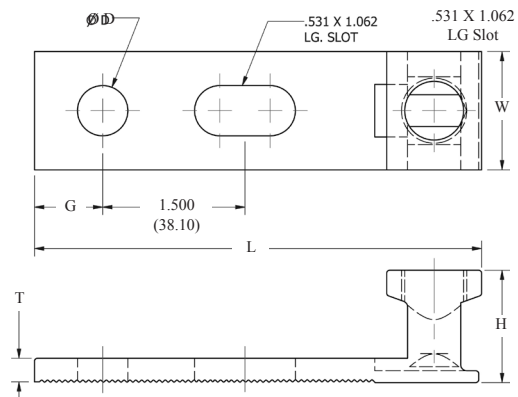

Fig. 2



Two Conductor Solderless Lugs

TYPE: 2AB/2AB2

PosiGrip®

90° C Rating (486B Listed)

Features

- Made of 6061-T6 Aluminum Alloy
- Electro-Tin Plated
- Patented PosiGrip® Design
- Positive Wire Stop
- Dual-Rated

Benefits

- Easy Installation
- Improved Pull-Out and Safety Features



Custom configurations available upon request.

Catalog Number	Fig	Screw Type mm	Stud Size* mm	Cond. Range AWG mm²	H	W	L	G	T
					Dimensions - inches				
					Dimensions - millimeters				
2AB-112	1	Slot or Hex	1/4	1/0-14	.78	1.13	1.31	.44	.16
			6.35	50-1.5	19.81	28.70	33.27	11.18	4.06
2AB-125	1	Slot or Hex	1/4	2/0-14	.78	1.25	1.47	.42	.19
			6.35	50-1.5	19.81	31.75	37.34	10.67	4.83
2AB-250	2	.31H	3/8	250-6	1.09	1.62	2.56	.53	.22
			7.87	9.53	120-16	27.69	41.15	65.02	13.46
2AB-350	2	.31H	3/8	350-6	1.19	1.92	2.88	.63	.25
			7.87	9.53	185-16	30.23	48.77	73.15	16.00
2AB-500	2	.38H	1/2	500-4	1.44	2.41	2.63	.63	.31
			9.65	12.70	240-16	36.58	61.21	66.80	16.00
2AB-600	2	.38H	1/2	600-2	1.56	2.41	3.19	.63	.38
			9.65	12.70	300-25	39.62	61.21	81.03	16.00
2AB-750	2	.38H	1/2	750-1/0	1.81	3.50	3.25	.88	.44
			9.65	12.70	300-50	45.97	88.90	82.55	22.35
2AB-1000	2	.50H	1/2	1000-500	1.94	3.50	3.50	.88	.44
			12.70	12.70	500-240	49.28	88.90	88.90	22.35

*This dimension can be altered per customer requirements.

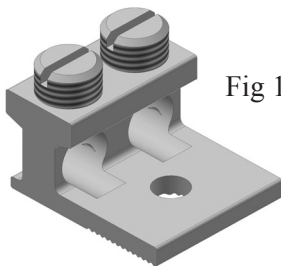

Fig 1

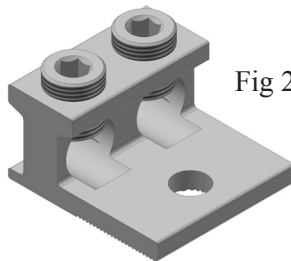
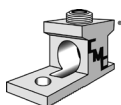
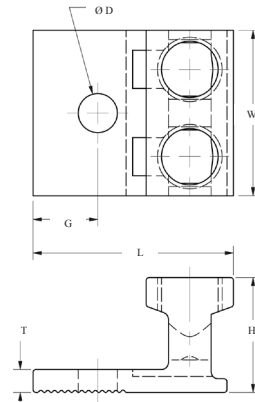

Fig 2



**CONNECTOR
MANUFACTURING
COMPANY**

www.cmclugs.com

513.860.4455

Panelboard Solderless Lugs

TYPE: ABV / ABV-2N

PosiGrip®

90° C Rating (486B Listed)

Features

- Made of 6061-T6 Aluminum Alloy
- Electro-Tin Plated
- Patented PosiGrip® Design
- Positive Wire Stop
- Dual-Rated

Benefits

- Easy Installation
- Improved Pull-Out and Safety Features



Custom configurations available upon request.

Catalog Number	Fig	Screw	Stud Size* mm	Cond. Range	H	W	L	G	T
					Dimensions - inches				
					Dimensions - millimeters				
2ABV-500	1	.38H	3/8	500-4	3.00	1.50	4.91	.38	.50
		9.65	9.53	240-16	76.20	38.10	124.71	9.65	12.70
2ABV-600	1	.38H	3/8	600-2	3.00	1.50	4.91	.38	.50
		9.65	9.53	300-25	76.20	38.10	124.71	9.65	12.70
2ABV-750	1	.38H	3/8	750-1/0	3.00	1.50	4.91	.38	.50
		9.65	9.53	300-50	76.20	38.10	124.71	9.65	12.70
3ABV-500	2	.38H	3/8	500-4	3.00	2.50	4.91	.38	.50
		9.65	9.53	240-16	76.20	63.50	124.71	9.65	12.70
3ABV-600	2	.38H	3/8	600-2	3.00	2.50	4.91	.38	.50
		9.65	9.53	300-25	76.20	63.50	124.71	9.65	12.70
3ABV-750	2	.38H	3/8	750-1/0	3.00	2.50	4.91	.38	.50
		9.65	9.53	300-50	76.20	63.50	124.71	9.65	12.70
4ABV-500	3	.38H	3/8	500-4	3.00	2.50	4.91	.38	.50
		9.65	9.53	240-16	76.20	63.50	124.71	9.65	12.70
4ABV-600	3	.38H	3/8	600-2	3.00	2.50	4.91	.38	.50
		9.65	9.53	300-25	76.20	63.50	124.71	9.65	12.70
4ABV-750	3	.38H	3/8	750-1/0	3.00	2.63	4.91	.38	.50
		9.65	9.53	300-50	76.20	66.80	124.71	9.65	12.70
2ABV-600-2N**	1	.38H	1/2	600-2	3.00	1.50	5.34	.63	.50
		9.65	12.70	300-25	76.20	38.10	135.74	16.00	12.70
3ABV-600-2N**	2	.38H	1/2	600-2	3.00	2.50	5.34	.63	.50
		9.65	12.70	300-25	76.20	63.50	135.74	16.00	12.70
4ABV-600-2N**	3	.38H	1/2	600-2	3.00	2.47	5.34	.63	.50
		9.65	12.70	300-25	76.20	62.74	135.74	16.00	12.70
6ABV-600-2N**	4	.38H	1/2	600-2	3.00	3.75	5.34	.63	.50
		9.65	12.70	300-25	76.20	95.25	135.74	16.00	12.70
2ABV-750-4N**	1	.38H	1/2	750-1/0	3.00	1.50	5.34	.50	.50
		9.65	12.70	300-50	76.20	38.10	135.74	12.70	12.70
3ABV-750-4N**	2	.38H	1/2	750-1/0	3.00	2.50	5.34	.50	.50
		9.65	12.70	300-50	76.20	63.50	135.74	12.70	12.70
4ABV-750-4N**	3	.38H	1/2	750-1/0	3.00	2.75	5.34	.50	.50
		9.65	12.70	300-50	76.20	69.85	135.74	12.70	12.70
6ABV-750-4N**	4	.38H	1/2	750-1/0	3.00	3.75	5.34	.50	.50
		9.65	12.70	300-50	76.20	95.25	135.74	12.70	12.70

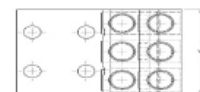
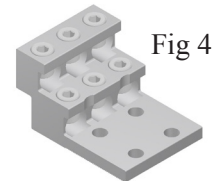
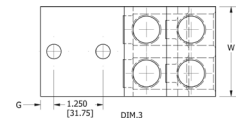
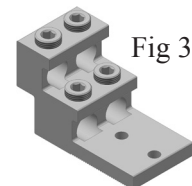
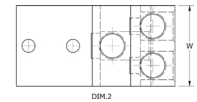
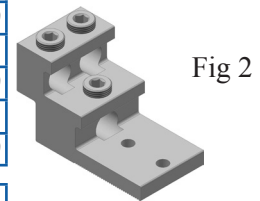
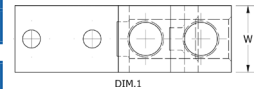
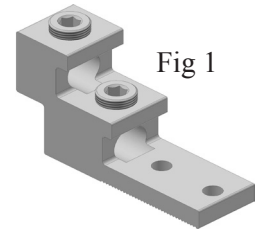

*This dimension can be altered per customer requirements.

**Products marked "-2N" or "-4N" are NEMA spaced.



www.cmclugs.com

513.860.4455

Single Conductor Solderless Lugs

TYPE: LA

90° C Rating (486B Listed)

Features

- Made of 6061-T6 Aluminum Alloy
- Electro-Tin Plated
- Dual-Rated

Benefits

- Easy Installation
- Connectors are Reusable



Custom configurations available upon request.

Catalog Number	Fig. No.	Cond. Range AWG mm	Stud Size* mm	H	W	L
				Dimensions - inches		
				Dimensions - millimeters		
LA-6-1	1	6-14	15/64	0.50	0.38	1.06
		16-1.5	5.85	12.70	9.65	26.92
LA-6	1	6-14	1/2	0.49	0.50	1.06
		16-1.5	6.35	12.45	12.70	26.92
LA-6-2	1	4-14	1/2	0.49	0.50	1.06
		16-1.5	6.35	12.45	12.70	26.92
LA-2	1	2-14	1/2	0.55	0.50	1.16
		25-1.5	6.35	13.97	12.70	29.46
LA-1/0	1	1/0-14	3/8	0.78	0.63	1.47
		50-1.5	9.65	19.81	16.00	37.34
LA-2/0	1	2/0-14	1/2	0.78	0.63	1.47
		50-1.5	6.35	19.81	16.00	37.34
LA-250	2	250-6	5/16	1.13	1.00	2.00
		120-16	7.87	28.70	25.40	50.80
LA-300	2	300-6	5/16	1.13	1.00	2.00
		150-16	7.87	28.70	25.40	50.80
LA-350	2	350-6	3/8	1.25	1.13	2.25
		185-16	9.65	31.75	28.70	57.15
LA-500	2	500-4	3/8	1.56	1.25	2.81
		240-16	9.65	39.62	31.75	71.37
LA-600	2	600-2	3/8	1.56	1.50	3.19
		300-25	9.65	39.62	38.10	81.03
LA-800	2	800-300	5/8	1.94	1.75	3.50
		400-150	16.00	49.28	44.45	88.90
LA-1000	2	1000-500	5/8	1.94	1.75	3.50
		500-240	16.00	49.28	44.45	88.90
LA-630	3	600-4/(2) 250-1/0	3/8	1.81	1.38	2.81
		300-16/(2) 120-50	9.65	45.97	35.05	71.37
LA-750	3	750-2/(2) 300-1/0	3/8	1.81	1.38	2.81
		300-25/(2) 150-50	9.65	45.97	35.05	71.37

*This dimension can be altered per customer requirements.

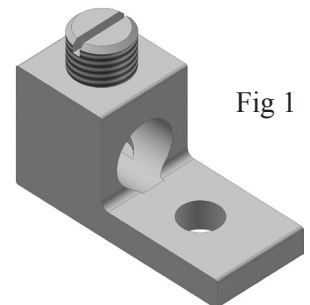

Fig 1

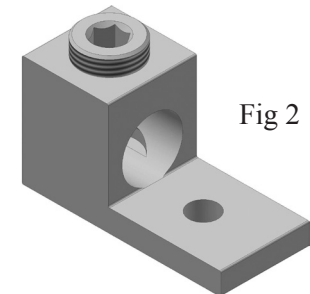

Fig 2

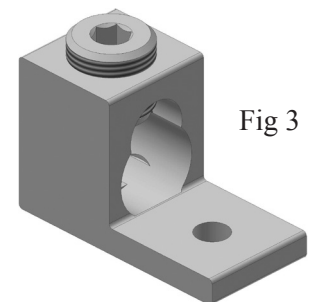
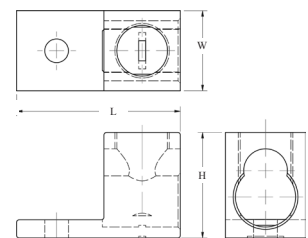

Fig 3



Single Conductor Solderless Lugs

90° C Rating (486B Listed)

TYPE: LA - Anti-Turn Series

Features

- Made of 6061-T6 Aluminum Alloy
- Anti-Turn Design
- Electro-Tin Plated
- Dual-Rated

Benefits

- Easy Installation
- Connectors are Reusable



Custom configurations available upon request.

Catalog Number	Cond. Range AWG mm	Stud Size* mm	H	W	L	R
			Dimensions - inches			
			Dimensions - millimeters			
LA-2R	4-14	1/4	.55	.50	1.16	.52
	16-1.5	6.35	13.97	12.70	29.46	13.21
LA-1/0R	1/0-14	1/4	.81	.63	1.47	.50
	50-1.5	6.35	20.57	16.00	37.34	12.70
LA-2/0R	2/0-14	1/4	.78	.60	1.20	.30
	50-1.5	6.35	19.81	15.24	30.48	11.94
LA-300R	300-6	1/4	1.13	.98	2.00	.49
	150-16	6.35	28.70	24.89	50.80	12.45
LA-350R	350-6	5/16	1.13	1.00	1.91	.50
	185-16	7.87	28.70	25.40	48.51	12.70
LA-625R	(1) 600-2 / (2) 250-1/0	3/8	1.62	1.38	2.62	1.14
	(1) 400-25 / (2) 150-50	9.65	39.88	35.05	66.55	22.35
LA-600R	600-2	3/8	1.57	1.38	2.75	.88
	300-25	9.65	39.88	35.05	69.85	22.35

*This dimension can be altered per customer requirements.

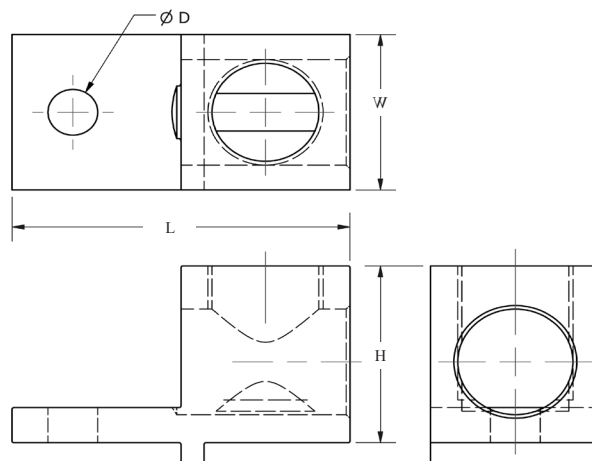
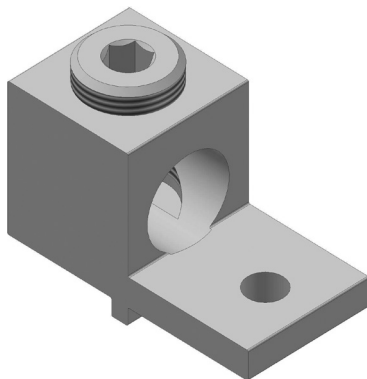

Two Conductor Solderless Lugs

TYPE: DLA

90° C Rating (486B Listed)

Features

- Made of 6061-T6 Aluminum Alloy
- Electro-Tin Plated
- Dual-Rated

Benefits

- Easy Installation
- Connectors are Reusable



Custom configurations available upon request.

Catalog Number	Fig. No.	Cond. Range AWG mm	Stud Size* mm	H	W	L
				Dimensions, inches		
				Dimensions, millimeters		
DLA-112	1	1/0-14 (2)	1/4	.78	1.13	1.47
		50-1.5 (2)	6.35	19.81	28.70	37.34
DLA-125	1	2/0-14 (2)	1/4	.78	1.25	1.47
		50-1.5 (2)	6.35	19.81	31.75	34.34
DLA-250	1	250-6 (2)	3/8	1.19	1.64	2.56
		120-16 (2)	9.65	30.23	41.66	65.02
DLA-350	1	350-6 (2)	1/2	1.25	1.92	2.88
		185-16 (2)	12.70	31.75	48.77	73.15
DLA-600	1	600-2 (2)	1/2	1.56	2.41	3.19
		300-25 (2)	12.70	39.62	61.21	81.03
DLA-800	1	800-300 (2)	5/8	1.94	3.50	3.50
		400-150 (2)	16.00	49.28	88.90	88.90
DLA-1000	1	1000-500 (2)	5/8	1.94	3.50	3.50
		500-240 (2)	16.00	49.28	88.90	88.90

*This dimension can be altered per customer requirements.

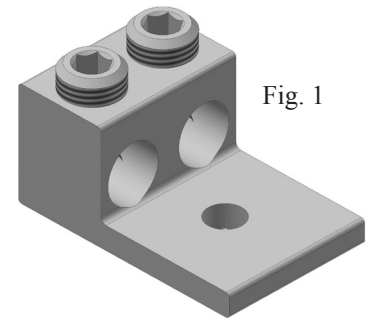
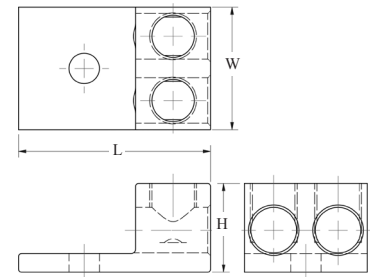

Fig. 1



Panelboard Solderless Lugs

90° C Rating (486B Listed)



TYPE: PV

Features

- Made of 6061-T6 Aluminum Alloy
- Electro-Tin Plated
- Dual-Rated

Benefits

- Easy Installation
- Connectors are Reusable

Custom configurations available upon request.

Catalog Number	Fig. No.	Cond. Range AWG mm ²	Stud Size* mm	Dimensions, inches		
				H	W	L
				Dimensions, millimeters		
PV2-300	1	300-6 (2)	5/16	2.00	1.00	3.00
		150-16 (2)	7.87	50.80	25.40	76.20
PV2-500	2	500-2 (2)	3/8 (2)	3.00	1.50	4.91
		240-25 (2)	9.65 (2)	76.20	38.10	124.71
PV2-600	2	600-2 (2)	3/8 (2)	3.00	1.50	4.91
		300-25 (2)	9.65 (2)	76.20	38.10	124.71
PV2-750	2	750-1/0 (2)	3/8 (2)	3.00	1.56	4.91
		300-50 (2)	9.65 (2)	76.20	39.62	124.71
PV3-500	3	500-2 (2)	3/8 (2)	3.00	2.50	4.91
		240-25 (2)	9.65 (2)	76.20	63.50	124.71
PV3-600	3	600-2 (3)	3/8 (2)	3.00	2.47	4.91
		300-25 (3)	9.65 (2)	76.20	62.74	124.71
PV3-750	3	750-1/0 (3)	3/8 (2)	3.00	2.84	4.91
		300-50 (3)	9.65 (2)	76.20	72.14	124.71
PV4-500	4	500-2 (2)	3/8 (2)	3.00	2.50	4.91
		240-25 (2)	9.65 (2)	76.20	63.50	124.71
PV4-600	4	600-2 (4)	3/8 (2)	3.00	2.47	4.91
		300-25 (4)	9.65 (2)	76.20	62.74	124.71
PV4-750	4	750-1/0 (4)	3/8 (2)	3.00	2.84	4.91
		300-50 (4)	9.65 (2)	76.20	72.14	124.71

*This dimension can be altered per customer requirements.

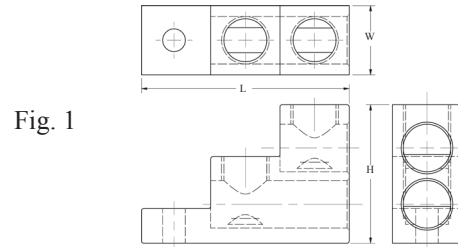

Fig. 1

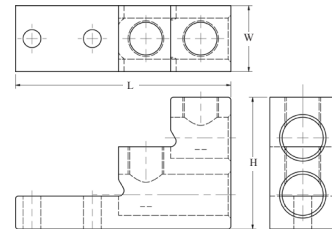

Fig. 2

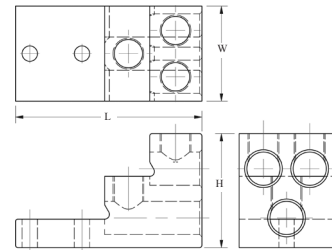

Fig. 3

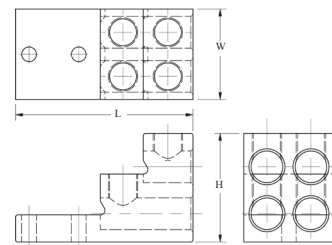

Fig. 4

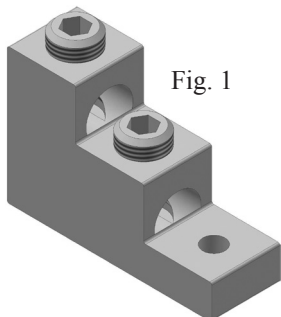

Fig. 1

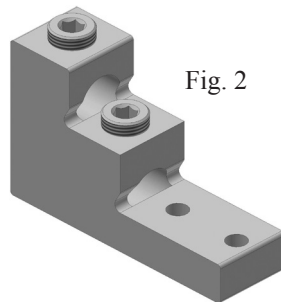

Fig. 2

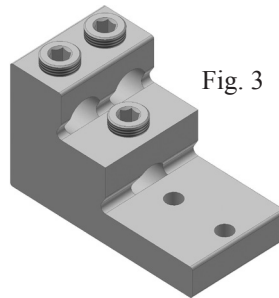
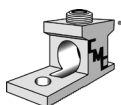
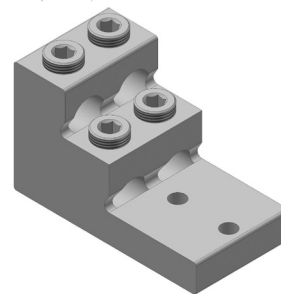

Fig. 3



**CONNECTOR
MANUFACTURING
COMPANY**

www.cmclugs.com

513.860.4455

Rectangular Connectors

TYPE: CA / LI



Features

- Made of 6061-T6 Aluminum Alloy
- Electro-Tin Plated
- Dual-Rated

Benefits

- Easy Installation
- Connectors are Reusable

Custom configurations available upon request.

Catalog Number	Fig. No.	Cond. Range AWG mm ²	Boss Tap* mm	H	W	L
				Dimensions, inches		
				Dimensions, millimeters		
CA-40S	1	4-14	.22 / 10-32	.48	.38	.38
		16-1.5	5.59	12.19	9.65	9.65
CA-60S	1	2-14	.22 / 10-32	.56	.47	.47
		25-1.5	5.84	14.22	11.94	11.94
CA-110S	1	1/0-14	.22 / 10-32	.61	.53	.62
		50-1.5	5.84	15.49	13.46	15.75
CA-150S	1	2/0-14	.22 / 10-32	.76	.58	.63
		50-1.5	5.84	19.30	14.73	16.00
CA-210	2	250-6	.29D / 1/4-20	1.00	.81	.94
		120-16	7.37D	25.40	20.57	23.88
CA-360	2	300-4	.29D / 1/4-20	1.00	.81	1.00
		150-16	7.37D	25.40	20.57	25.40
CA-380	2	350-6	.29D / 1/4-20	1.13	1.00	.94
		185-16	7.37D	28.70	25.40	23.88
CA-635	3	600-4 / (2) 250-4	Flat / 1/4-20 (2)	1.69	1.22	1.25
		200-16 / (2) 120-16		42.93	30.99	31.75
CA-750	3	750-250 / (2) 250-3/0	Flat / 1/4-20 (2)	2.06	1.38	1.25
		300-120 / (2) 120-85		52.32	35.05	31.75

*This dimension can be altered per customer requirements.

Lay-in style collars - Use where lay-in feature is desired.

LI-250	4	250-6		1.40	1.25	1.00
		120-10		35.56	31.75	25.40
LI-500	4	500-3/0		1.63	1.66	1.50
		240-70		41.40	42.16	38.10
LI-501	4	600-2		2.00	1.50	1.25
		400-25		50.80	38.10	31.75
LI-750	4	750-1/0		2.50	1.62	1.50
		300-50		63.50	41.15	38.10
LI-3501	4	350-6		1.40	1.35	1.00
		n/a		n/a	n/a	n/a

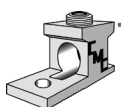
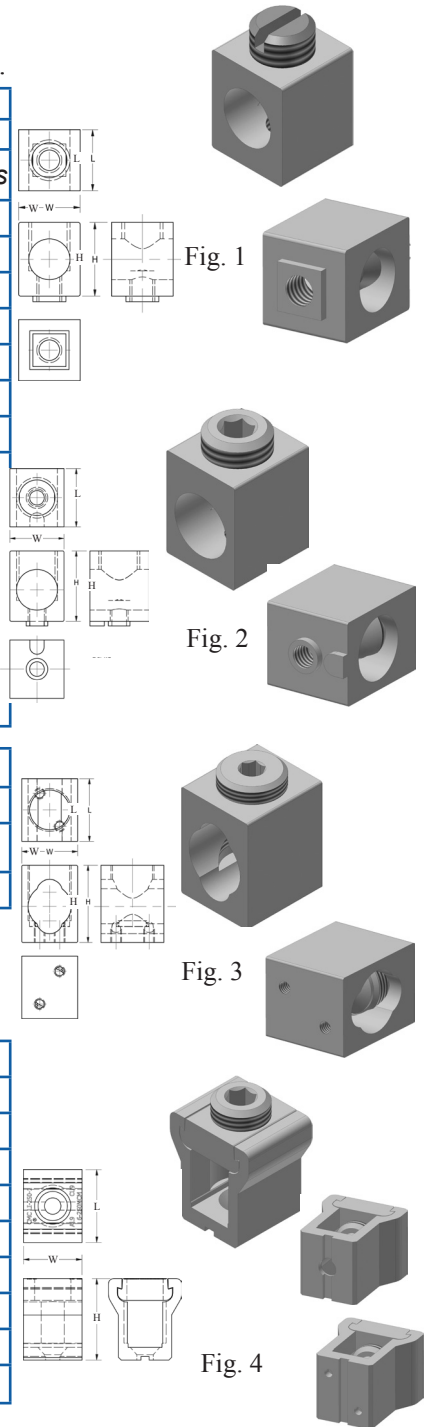

**CONNECTOR
MANUFACTURING
COMPANY**

www.cmclugs.com

513.860.4455

Splicers / Reducers

90° C Rating (486B Listed)



TYPE: SR- Solid Bearers

Features

- Made of 6061-T6 Aluminum Alloy
- Electro-Tin Plated
- Dual-Rated
- Specialized Design

Benefits

- Easy Installation
- Center Barrier Prevents Dissimilar Metals from Contact

Custom configurations available upon request.

Catalog Number	Fig. No.	Cond. Range AWG mm ²	Strip Length mm	H	W	L
				Dimensions, inches		
				Dimensions, millimeters		
SR-2	1	2-14	.63	.56	.50	1.38
		25-1.5	16.00	14.22	12.70	35.05
SR-0	1	1/0-14	.88	.75	.75	1.91
		50-1.5	22.35	19.05	19.05	48.51
SR-250	2	250-6	.94	1.13	1.00	3.94
		120-16	23.88	28.70	25.40	100.08
SR-350	2	350-6	2.06	1.19	1.13	4.19
		185-16	52.32	30.23	28.70	106.43
SR-500	2	500-2	2.44	1.50	1.38	5.00
		240-25	61.98	38.10	35.05	127.00
SR-750	3	750-250	3.06	1.75	1.63	6.25
		300-120	77.72	44.45	41.40	158.75
SR-1000	3	1000-500	3.94	2.00	1.75	8.00
		500-240	100.08	50.80	44.45	203.20

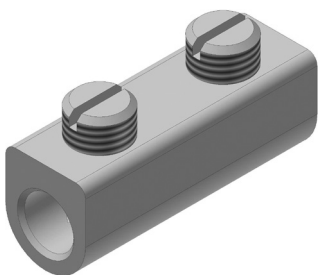

Fig. 1

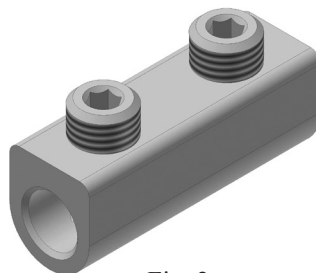
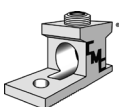
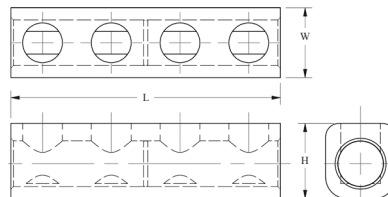
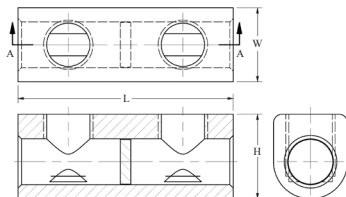

Fig. 2



Fig. 3



**CONNECTOR
MANUFACTURING
COMPANY**

www.cmclugs.com

513.860.4455

Aluminum Neutral Bars

TYPE: NA / SCB

Features

- Made of 6061-T6 Aluminum Alloy
- Electro-Tin Plated
- Dual-Rated

Benefits

- Easy Installation



Custom configurations available upon request.

Catalog Number	Fig. No.	Conductor Range <i>mm²</i>	H	W
			Dimensions, inches	
			<i>Dimensions, millimeters</i>	
NA-30	1	6-14	.44	.31
		16-1.5	11.18	7.87
NA-35	1	4-14	.50	.31
		16-1.5	12.70	7.87
NA-70	1	4-14	.50	.38
		16-1.5	12.70	9.65
NA-125	1	1/0-14	.75	.56
		50-1.5	19.05	14.22
NA-150	1	2/0-6	.75	.56
		50-10	19.05	14.22
NA-250	1	250-6	1.00	.88
		120-16	25.40	22.35

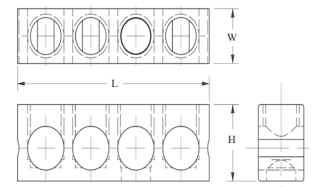
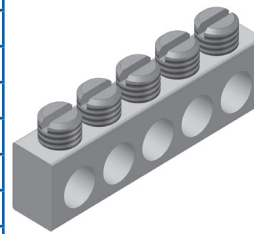

Fig. 1

NA-130	2	1/0-14	.75	.56
		50-1.5	19.05	14.22
NA-140	2	2/0-14	.75	.56
		50-1.5	19.05	14.22
NA-300	2	300-6	1.16	.97
		150-16	29.46	24.64

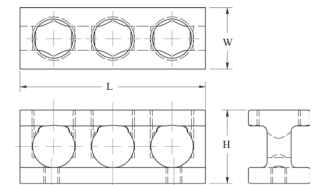
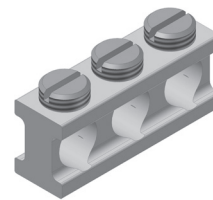

Fig. 2

*SCB-1/0	3	1/0-14 / 6-14	.62	.38
		50-1.5 / 16-1.5	15.75	9.65
*SCB-2/0	3	2/0-14 / 6-14	.69	.38
		50-1.5 / 16-1.5	17.45	9.65

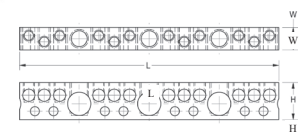
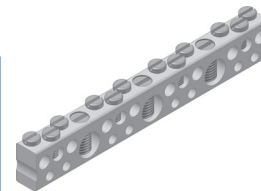

Fig. 3

*This bar is also approved as an equipment ground and is 90° C rated.

The number of outlets, outlet spacing and mounting hole locations can be established according to individual requirements. **When ordering neutral bars please add a suffix to indicate the number of usable wire ports required. Ex: NA30-8 would result in an NA30 style neutral bar with eight (8) wire ports.**



Aluminum Neutral Bar Assemblies

TYPE: SNB-350

Features

- Made of 6061-T6 Aluminum Alloy
- Electro-Tin Plated
- Dual-Rated

Benefits

- Easy Installation
- Can Be Used with Insulating Block

Custom configurations available upon request.

Catalog Number	Fig. No.	Conductor Range <i>mm²</i>	Wire Tap Range <i>mm²</i>	H	W	L	Circuit Holes
				Dimensions, inches			
				Dimensions, millimeters			
SNB-350-12	1	350-6	6-14	1.13	2.53	2.17	12
		185-16	16-1.5	28.70	64.26	55.12	
SNB-350-24	1	350-6	6-14	1.13	2.53	3.43	24
		185-16	16-1.5	28.70	64.26	87.12	
SNB-350-30	1	350-6	6-14	1.13	2.53	4.06	30
		185-16	16-1.5	28.70	64.26	103.12	
SNB-350-36	1	350-6	6-14	1.13	2.53	4.77	36
		185-16	16-1.5	28.70	64.26	121.16	
SNB-350-42	1	350-6	6-14	1.13	2.53	5.27	42
		185-16	16-1.5	28.70	64.26	133.86	

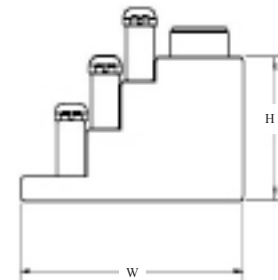
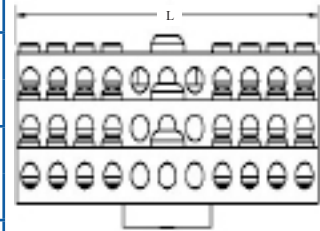

SNB-350-12 W/SNBI-1	2	350-6	6-14	1.13	2.53	2.17	12
		185-16	16-1.5	28.70	64.26	55.12	
SNB-350-24 W/SNBI-1	2	350-6	6-14	1.13	2.53	3.43	24
		185-16	16-1.5	28.70	64.26	87.12	
SNB-350-30 W/SNBI-1	2	350-6	6-14	1.13	2.53	4.06	30
		185-16	16-1.5	28.70	64.26	103.12	
SNB-350-36 W/SNBI-1	2	350-6	6-14	1.13	2.53	4.77	36
		185-16	16-1.5	28.70	64.26	121.16	
SNB-350-42 W/SNBI-1	2	350-6	6-14	1.13	2.53	5.27	42
		185-16	16-1.5	28.70	64.26	133.86	

The number of outlets, outlet spacing and mounting hole locations can be established according to individual requirements.

Fig. 1

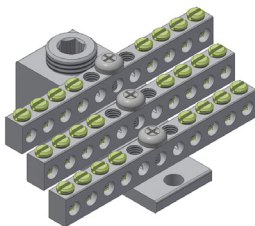
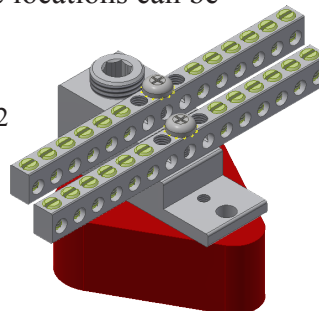

Fig. 2



CMC® Copper Connectors

Connector Manufacturing Company® fabricates the best in electrolytic copper electrical connectors. Copper connectors are formed from 100% pure electrolytic copper to eliminate the effects upon conductivity when alloys are utilized to reduce costs.

CMC® copper connectors are either extruded from pure electrolytic copper or formed from copper tubing carefully shaped to size. They may also be produced from copper strip which is used to form the tang or bus connection. These light weight connectors will perform better than many of the heavier, bulkier cast copper alloyed products on the market. This saves the customer the cost of metal, freight and space, while gaining top conductivity.

We therefore, offer these advantages in connector design:

1. Compact Design.
2. High Strength - low heat rise copper.
3. Relatively light weight construction.
4. Economy and efficiency.
5. Tested products in accordance with Underwriters Laboratories and the Canadian Standards Association requirements for listing.

These features together with our dedication for the highest quality standards available and an unsurpassed service level, provide our customers with maximum reliability.

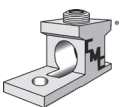

**CONNECTOR
MANUFACTURING
COMPANY**

www.cmclugs.com

513.860.4455

Copper Solderless Lugs

TYPE: CF / CFS

Features

- Made of Pure Electrolytic Copper
- Plain Copper Finish

Benefits

- Easy Installation
- Connectors are Reusable
- Specialized for Copper Conductors ONLY



Custom configurations available upon request.

Catalog Number	Fig. No.	Cond. Range AWG mm ²	Stud Size* mm	Dimensions, inches		
				H	W	L
				Dimensions, millimeters		
CF-25	1	10-14	1/8	.37	.31	1.00
		4-1.5	3.18	9.40	7.87	25.40
CF-35	1	6-14	3/16	.56	.37	1.09
		16-1.5	4.76	14.22	9.40	27.69
CF-70	1	4-14	1/4	.62	.50	1.31
		16-1.5	6.35	15.75	12.70	33.27
CF-90	1	2-8	1/4	.72	.50	1.47
		25-10	6.35	18.29	12.70	37.34
CF-125	1	1/0-2	3/8	.88	.62	1.79
		50-25	9.53	22.35	15.75	45.47
CF-175	2	3/0-4	3/8	1.03	.75	2.05
		70-16	9.53	26.16	19.05	52.07
CF-225	2	4/0-2	3/8	1.20	1.00	2.56
		95-25	9.53	30.48	25.40	65.02
CF-300	2	350-1/0	3/8	1.41	1.00	3.25
		185-50	9.53	35.81	25.40	82.55
CF-400	2	500-1/0	3/8	1.56	1.50	4.31
		240-50	9.53	39.62	38.10	109.47
CF-650	2	1000-600	1/2	2.34	2.00	4.75
		500-300	12.70	59.44	50.80	120.65

CFS-25	3	10-14	1/8	.37	.31	1.00
		4-1.5	3.18	9.40	7.87	25.40
CFS-35	3	6-14	3/16	.56	.38	1.14
		16-1.5	4.76	14.22	9.65	28.96
CFS-70	3	4-14	1/4	.63	.50	1.25
		16-1.5	6.35	16.00	12.70	31.75
CFS-90	3	2-8	1/4	.71	.50	1.46
		25-10	6.35	18.03	12.70	37.08
CFS-125	3	1/0-2	3/8	.88	.62	1.94
		50-25	9.53	22.35	15.75	49.28
CSF-175	4	3/0-4	3/8	1.03	.75	2.23
		70-16	9.53	26.16	19.05	56.64
CFS-225	4	4/0-2	3/8	1.20	1.00	2.38
		95-25	9.53	30.48	25.40	60.45
CFS-300	4	350-1/0	3/8	1.41	1.00	3.25
		185-50	9.53	35.81	25.40	82.55
CFS-400	4	500-1/0	3/8	1.56	1.50	3.87
		240-50	9.53	39.62	38.10	98.30
CFS-650	4	1000-600	1/2	2.34	2.00	5.00
		500-300	12.70	59.44	50.80	127.00

*This dimension can be altered per customer requirements.

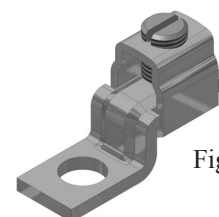

Fig. 1

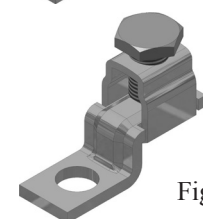

Fig. 2

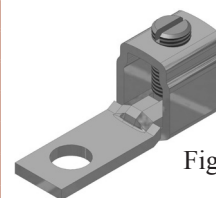
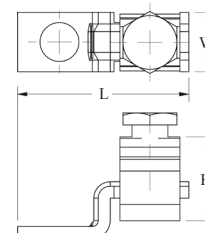

Fig. 3

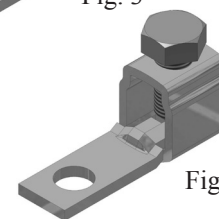
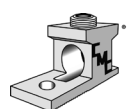
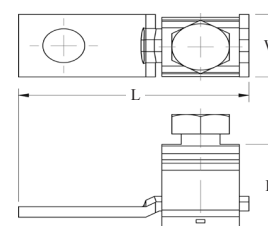

Fig. 4



**CONNECTOR
MANUFACTURING
COMPANY**

www.cmclugs.com

513.860.4455

Copper Solderless Lugs

TYPE: BC

PosiGrip®
90° C Rating (486B Listed)



Features

- Made of Pure Electrolytic Copper
- PosiGrip®
- Unique I-Beam Design
- Positive Wire Stop

Benefits

- Easy Installation
- Improved Pull-Out and Safety Features
- Specialized for Copper Conductors ONLY

U.S. Patent 4,946,405
U.S. Patent 309,129
U.S. Patent 5,030,131

Custom configurations available upon request.

Catalog Number	Fig. No.	Screw Type	Stud Size* mm	Cond. Size AWG mm ²	H	W	L	G	T
					Dimensions, inches				
					Dimensions, millimeters				
BC-50	1	Slot	1/4	6-14	.44	.44	.81	.22	.09
			6.35	16-1.5	12.19	12.19	20.57	5.59	2.92
BC-70	1	Slot	1/4	2-14	.50	.50	1.00	.27	.09
			6.35	25-1.5	12.70	12.70	25.40	6.86	2.92
BC-112	1	Slot	1/4	1/0-14	.66	.56	1.12	.28	.16
			6.35	50-1.5	16.76	14.22	28.45	7.11	4.06
BC-125	1	Slot	1/4	2/0-14	.78	.56	1.25	.31	.19
			6.35	50-1.5	19.81	14.22	31.75	7.87	4.83
BC-250	2	.31H	5/16	250-6	.97	.88	1.72	.44	.19
		7.87	7.94	120-16	24.64	22.35	43.69	11.18	4.83
BC-350	2	.31H	5/16	350-6	1.13	.94	2.00	.45	.19
		7.87	7.94	185-16	28.70	23.88	50.80	11.43	4.83
BC-500	2	.38H	3/8	500-4	1.38	1.25	2.37	.63	.26
		9.65	9.53	240-16	35.05	31.75	60.20	16.00	6.60
BC-600	2	.38H	3/8	600-2	1.50	1.19	2.50	.75	.26
		9.65	9.53	300-25	38.10	30.23	63.50	19.05	6.60
BC-750	2	.38H	5/8	800-300	1.68	1.38	2.75	.75	.31
		9.65	15.88	500-150	42.67	35.05	69.85	19.05	7.87
BC-1000	2	.50H	5/8	1000-500	1.88	1.50	2.87	.75	.31
		12.70	15.88	500-240	47.75	38.10	72.70	19.05	7.87

*This dimension can be altered per customer requirements.

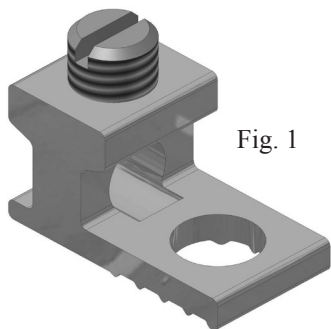

Fig. 1

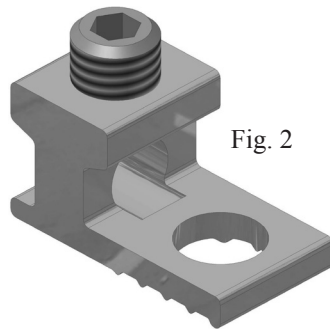
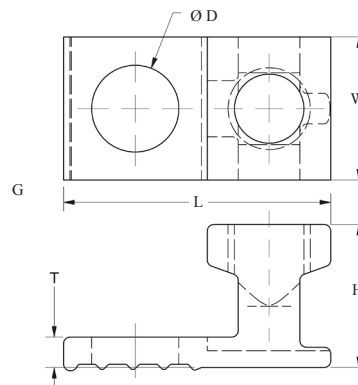

Fig. 2



Copper Solderless Lugs

TYPE: 2BC

PosiGrip®
90° C Rating (486B Listed)



Features

- Made of Pure Electrolytic Copper
- PosiGrip®
- Unique I-Beam Design
- Positive Wire Stop

Benefits

- Easy Installation
- Improved Pull-Out and Safety Features
- Specialized for Copper Conductors ONLY

U.S. Patent 4,946,405
U.S. Patent 3,09,129
U.S. Patent 5,030,131

Custom configurations available upon request.

Catalog Number	Fig. No.	Screw Type	Stud Size* mm	Cond. Size AWG mm ²	H	W	L	G	T
					Dimensions, inches				
					Dimensions, millimeters				
2BC-112	1	Slot	1/4	1/0-14	.66	1.13	1.12	.28	.16
			6.35	50-1.5	16.76	28.70	28.45	7.11	4.06
2BC-125	1	.19H	1/4	2/0-14	.78	1.25	1.25	.31	.19
			4.83	6.35	50-1.5	19.81	31.75	31.75	7.87
2BC-250	2	.31H	3/8	250-6	.97	1.62	1.72	.44	.19
			7.87	9.53	120-16	24.64	41.15	43.69	11.18
2BC-350	2	.31H	1/2	350-6	1.13	1.92	2.00	.50	.19
			7.87	12.70	185-16	28.70	48.77	50.80	12.70
2BC-500	2	.31H	1/2	500-4	1.38	2.41	2.37	.56	.26
			7.87	12.70	240-16	35.05	61.21	60.20	14.22
2BC-600	2	.31H	1/2	600-2	1.50	2.41	2.50	.63	.26
			7.87	12.70	300-25	38.10	61.21	63.50	16.00
2BC-750	2	.31H	5/8	750-300	1.68	3.25	2.75	.75	.31
			7.87	15.88	300-150	42.67	82.55	69.85	19.05
2BC-1000	2	.50H	5/8	1000-500	1.88	3.50	2.87	.75	.31
			12.70	15.88	500-300	47.75	88.90	72.90	19.05

*This dimension can be altered per customer requirements.

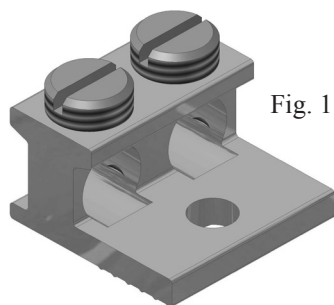

Fig. 1

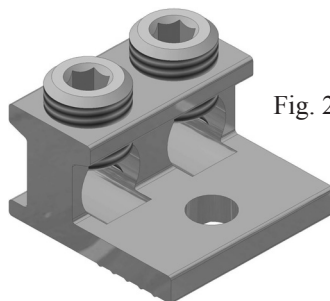
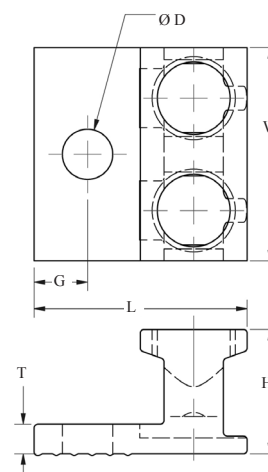

Fig. 2



Copper Solderless Connectors and Collars

TYPE: FT

90° C Rating (486B Listed)

Features

- Made of Pure Electrolytic Copper
- Plain Copper Finish

Benefits

- Easy Installation
- Connectors are Reusable
- Specialized for Copper Conductors ONLY

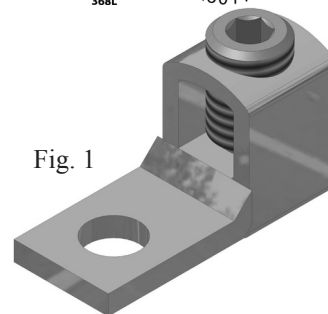
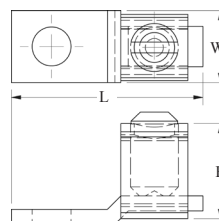

Fig. 1



Custom configurations available upon request.

Catalog Number	Fig. No.	Cond. Range AWG mm ²	Stud Size* mm	H	W	L
				Dimensions, inches		
				Dimensions, millimeters		
FT-65	1	6-14	1/8	.48	.38	1.00
		16-1.5	3.18	12.19	9.65	25.40
FT-70	1	4-14	1/8	.52	.50	1.25
		16-1.5	3.18	13.21	12.70	31.75
FT-90	1	1/0-14	3/16	.75	.62	1.26
		50-1.5	4.76	19.05	15.75	32.00

*This dimension can be altered per customer requirements.

TYPE: C / CS

Features

- Made of Pure Electrolytic Copper
- Plain Copper Finish

Benefits

- Easy Installation
- Connectors are Reusable



Fig. 2

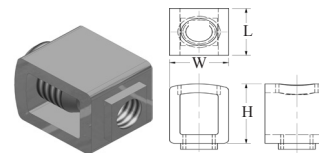

Custom configurations available upon request.

Catalog Number	Fig. No.	Cond. Range AWG mm ²	Boss Tap* mm	H	W	L
				Dimensions, inches		
				Dimensions, millimeters		
C-54-S	2	6-14	.22S / 10-32	.47	.35	.38
		16-1.5	5.59	11.94	8.89	9.65
C-58-S	2	4-14	.25S / 10-32	.52	.46	.46
		16-1.5	6.35	13.21	11.68	11.68
C-68-S	2	1/0-14	.25S / 12-24	.61	.53	.62
		50-1.5	6.35	15.49	13.46	15.75

CS-105	3	1/0-14		.88	.55	.63
		50-1.5		22.35	13.97	16.00
CS-175	3	4/0-2		1.09	.75	.88
		95-25		27.69	19.05	22.35
CS-200	3	250-6		.88	.81	1.00
		120-16		22.35	20.57	25.40

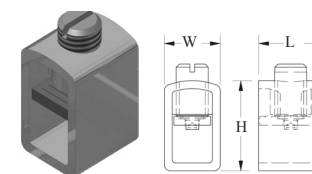
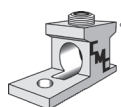

Fig. 3

*This dimension can be altered per customer requirements.



**CONNECTOR
MANUFACTURING
COMPANY**

www.cmclugs.com

513.860.4455

Copper Splicers

TYPE: C2/C4

Features

- Made of Pure Electrolytic Copper
- Plain Copper Finish

Benefits

- Easy Installation
- Connectors are Reusable

90° C Rating (486B Listed)



Custom configurations available upon request.

Catalog Number	Fig. No.	Cond. Range AWG mm ²	Dimensions, inches		
			H	W	L
			Dimensions, millimeters		
C2-25	1	8-12	.48	.25	.56
		10-2.5	12.19	6.35	14.22
C2-35	1	6	.56	.34	.88
		16	14.22	8.64	22.35
C2-50	1	4	.63	.39	.88
		16	16.00	9.91	22.35
C2-70	1	2	.72	.50	1.00
		25	18.29	12.70	25.40
C2-125	1	2/0-1/0	.88	.59	1.25
		70-50	22.35	14.99	31.75
C2-225	1	250-3/0	1.31	.86	2.31
		120-70	33.27	21.84	58.67

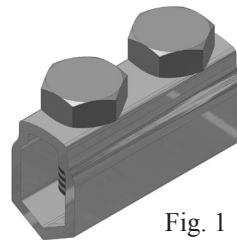
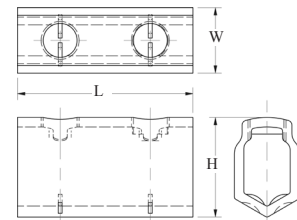

Fig. 1



C4-25	2	8-12	.45	.25	1.63
		10-2.5	11.43	6.35	41.40
C4-35	2	6	.69	.33	1.75
		16	17.53	8.38	44.45
C4-50	2	4	.75	.38	1.75
		16	19.05	9.65	44.45
C4-70	2	2	.91	.47	2.00
		25	23.11	11.94	50.80
C4-125	2	2/0-1/0	.88	.59	2.50
		70-50	22.35	14.99	63.50
C4-225	2	250-3/0	1.31	.86	4.63
		120-70	33.27	21.84	117.60

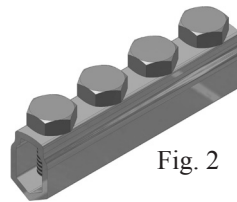
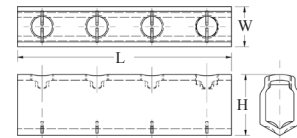

Fig. 2



Copper Grounding Connectors

TYPE: CL

90° C Rating (486B Listed)



Features

- Made of Pure Electrolytic Copper
- Plain Copper Finish
- Designed for Conduit Grounding Bushings
- UL Approved for Direct Burial.

Benefits

- Easy Installation
- Connectors are Reusable
- Specialized for Copper Conductors ONLY

Custom configurations available upon request.

Catalog Number	Fig. No.	Cond. Range AWG mm ²	Stud Size* mm	Dimensions, inches		
				H	W	L
				Dimensions, millimeters		
CL-50S	1	4-14	3/16	.78	.38	1.07
		16-1.5	4.76	19.81	9.65	27.18
CL-112S	1	1/0-14	1/4	1.17	.60	1.50
		50-1.5	6.35	29.72	15.24	38.10
CL-200S	2	3/0-6	5/16	1.56	.80	2.00
		70-16	7.94	39.62	20.32	50.80
CL-252S	2	250-6	5/16	1.79	.80	2.20
		120-16	7.94	45.47	20.32	55.88

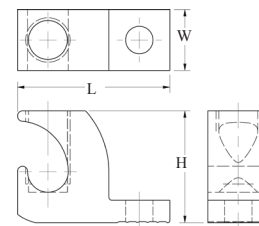

*This dimension can be altered per customer requirements.

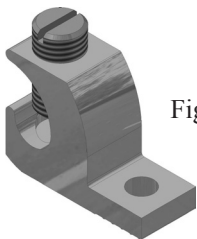

Fig. 1

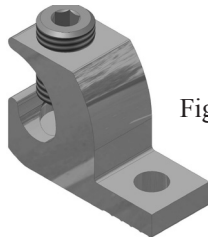
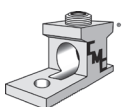

Fig. 2



**CONNECTOR
MANUFACTURING
COMPANY**

www.cmclugs.com

513.860.4455

Copper Neutral Bars

TYPE: N70 / LCB

Features

- Made of Pure Electrolytic Copper
- Plain Copper Finish

Benefits

- Easy Installation
- Connectors are Reusable
- Specialized for Copper Conductors ONLY



Custom configurations available upon request.

Catalog Number	Fig. No.	No. of Taps	Wire Range		Stud Size* mm	H	W	L
			Line mm	Circuit mm		Dimensions, inches		
						Dimensions, millimeters		
N70-8-1	1	6	4-14	6-14	3/16 (2)	.48	.35	3.57
			16-1.5	16-1.5	4.76 (2)	12.19	8.89	90.68
N70-10-1	1	8	4-14	6-14	3/16 (2)	.48	.35	4.37
			16-1.5	16-1.5	4.76 (2)	12.19	8.89	111.00
N70-12-1	1	10	4-14	6-14	3/16 (2)	.48	.35	5.16
			16-1.5	16-1.5	4.76 (2)	12.19	8.89	131.06
N70-14-1	1	12	4-14	6-14	3/16 (2)	.48	.35	5.95
			16-1.5	16-1.5	4.76 (2)	12.19	8.89	151.13
N70-16-1	1	14	4-14	6-14	3/16 (2)	.48	.35	6.74
			16-1.5	16-1.5	4.76 (2)	12.19	8.89	171.20
N70-174	1	174		6-14	None	.47	.34	68.91
				16-1.5		11.94	8.64	1750.31

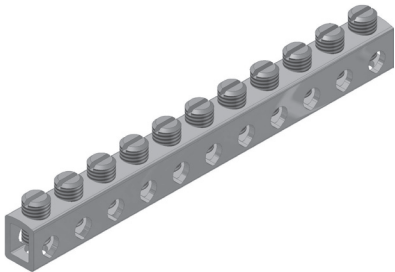
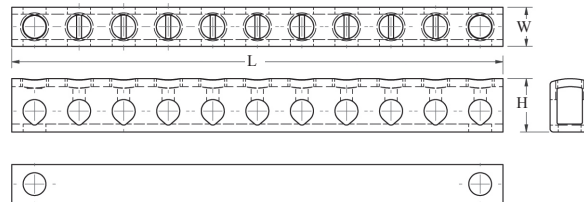

Fig. 1



Custom configurations available upon request.

Catalog Number	Fig. No.	Cond. Range mm ²	H	W
			Dimensions, inches	
			Dimensions, millimeters	
*LCB-1/0	2	1/0-14 / 6-14	.63	.38
		50-1.5 / 16-1.5	16.00	9.65
*LCB-2/0	2	2/0-14 / 6-14	.69	.38
		50-1.5 / 16-1.5	17.45	9.65

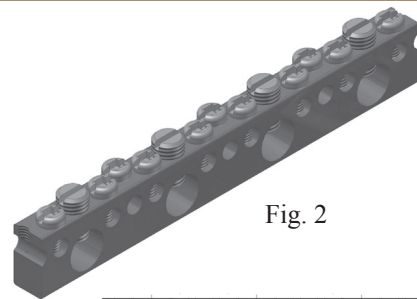
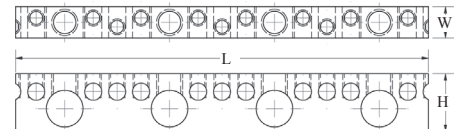

Fig. 2



*This bar is also approved as an equipment ground.

The number of outlets, outlet spacing and mounting hole locations can be established according to individual requirements. **When ordering neutral bars please add a suffix to indicate the number of usable wire ports required. Ex: NA30-8 would result in an NA30 style neutral bar with eight (8) wire ports.**

Installation Instructions

1. Measure the length of the wire hole in the connector, with a measuring device.
2. Measure and mark the conductor cable approximately 1/4" longer than the connector.
3. Strip the insulation from the cable with an appropriate stripping tool; be careful not to damage the conductor wire while performing this operation.
4. If the wire cable (conductor) is corroded or blemished in any way, clean the exposed end of the cable with emery cloth or wire brush dependent upon the severity of the corrosion to remove oxides from the surface of the conductor.
5. Prior to installation of the conductor to the connector, apply a generous amount of oxide inhibitor to the bare portion of the conductor.
6. Rotate the conductor back and forth to evenly distribute the inhibitor.
7. Install the conductor into the connector leaving approximate 1/4" of exposed conductor visible. Be sure the installed conductor is equal in length of the wire hole. Snug with an Allen wrench.
8. Torque the set screw to the recommended value with a torque wrench. After a minute, retighten the screw again to the recommended torque value.



1



2



3



4

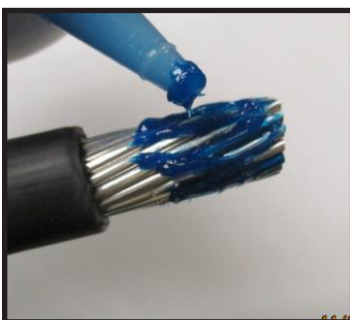

5

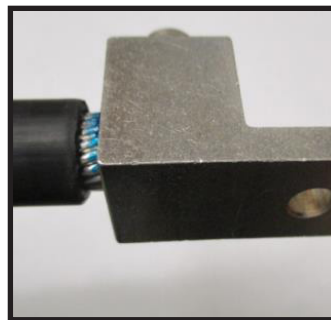

6

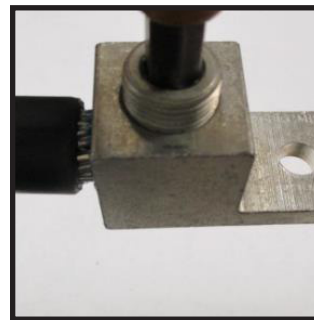

7

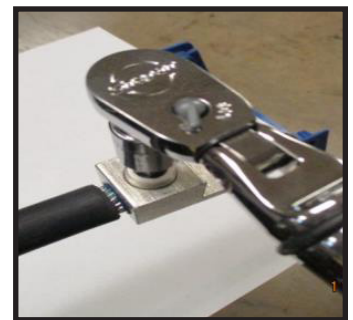

8

Tightening Torque Values

Tightening Torque Values for Mechanical Screw Connectors

AWG. or Circular Mill Size	Slotted Head Screws				Hexagonal Head Screw	
	Slot Width .047 in (1.2 mm) or less		Slot Width More than .047 in (1.2 mm)			
	Slot Length .25 in (6.4 mm) or less		Slot Length More than .25 in (6.4 mm)			
	in-lbf	N-m	in-lbf	N-m		
30-10	20	2.3	35	4.0	75	8.5
8	25	2.8	40	4.5	75	8.5
6-4	35	4.0	45	5.1	110	12.4
3	35	4.0	50	5.6	150	16.9
2	40	4.5	50	5.6	150	16.9
1			50	5.6	150	16.9
1/0 - 2/0			50	5.6	180	20.3
3/0 - 4/0			50	5.6	250	28.2
250-350			50	5.6	325	36.7
400			50	5.6	325	36.7
500			50	5.6	375	42.4
600-750			50	5.6	375	42.4
800-1000			50	5.6	500	56.5
1250-2000					600	67.8

Tightening Torque Values for Socket Head Screw Connectors

Internal Socket Size Across Flats		Tightening Torque	
in	mm	Inch Pounds	Newton Meters
1/8	3.2	45	5.1
5/32	4.0	100	11.3
3/16	4.8	120	13.6
7/32	5.6	150	16.9
1/4	6.4	200	22.6
5/16	7.9	275	31.1
3/8	9.5	375	42.4
1/2	12.7	500	56.5
9/16	14.3	600	67.8

Additional Torque Information

Table shows the recommended Tightening torques for silicon bronze, stainless steel, galvanized steel and aluminum alloy hardware.

Bolt Diameter	Nominal Torque Values			
	Silicon Bronze, Galvanized or Stainless Steel		Aluminum Alloy (lubricated)	
	Ft. - Lbs.	Inch-Lbs.	Ft. - Lbs.	Inch - Lbs.
5/16-18	15	180	-	-
3/8-16	20	240	14	168
1/2-13	40	480	25	300
5/8-11	55	660	40	480
3/4-10	80	960	70	840

Additional Torque Information

For optimum efficiency, it is necessary that the correct bolt, nut, and washer combination be used with the correct combination of conductor materials. This table shows acceptable methods of joining different combination of bus bar. Where different combinations of metals are being joined, a follow-up device such as a conical pressure washer is usually recommended if one, or both, bus materials are soft drawn aluminum. If both bars are hard drawn, large flat washers will suffice regardless of the bolt materials.

Other considerations which should be taken into account when selecting hardware are corrosion and vibration. For example, if severe corrosion is anticipated, non-corrosive materials such as stainless steel or silicon bronze, should be selected in preference to galvanized steel. If vibration is anticipated, the use of locking washers should be considered.



Methods of Joining Bus Bars

If "A" Bar is	Copper	Aluminum	Steel	Aluminum	Steel
If "B" Bar is	Copper	Copper	Copper	Aluminum	Aluminum
Hand drawn bus such as Al Alloy 	(1) Silicon Bronze (2) Stainless Steel	(1) Silicon Bronze (2) Aluminum (3) Stainless Steel	(1) Aluminum (2) Stainless Steel	(1) Aluminum (2) Stainless Steel (3) Silicon Bronze, Plated	(1) Aluminum (2) Stainless Steel
Soft drawn bus such as EC-H13 AL 	(1) Silicon Bronze (2) Stainless Steel	(1) Silicon Bronze (2) Aluminum (3) Stainless Steel (4) Conical Pressure Washer Plated or Stainless Steel	(1) Silicon Bronze (2) Stainless Steel	(1) Aluminum (2) Stainless Steel (3) Silicon Bronze Plated (4) Conical Pressure Washer Plated or Stainless Steel	(1) Aluminum (2) Stainless Steel (3) Silicon Bronze Plated (4) Conical Pressure Washer Plated or Stainless Steel

(1) Denotes preferred hardware usage. *Note: Contact sealant recommended between aluminum to aluminum and aluminum to copper connections unless other protective measures are taken.*

Bar Connections:

The Tang of a compression or mechanical connector is a bus bar, which connects to another bus bar. If you remember the rule about wire brushing and using joint compound with bare (unplated) aluminum, you cannot go wrong. Plated parts should be cleaned with a solvent if they are dirty, but never abrade or otherwise disturb the plating! Figure shows a typical bar connection and the type of hardware used.

Contact surface must be clean. Use a joint compound with bare aluminum. Conical pressure washer is usually recommended if one, or both, bus materials are soft drawn aluminum.

Decimal Equivalents

Drill	Equivalent	Drill	Equivalent	Drill	Equivalent	Drill	Equivalent	Drill	Equivalent
1/16	.0625	53/64	.8281	1 19/32	1.59737	2 3/64	2.3593	3 1/4	3.2500
5/64	.07812	27/32	.8437	1 39/64	1.6093	2 3/8	2.3750	3 9/32	3.2812
3/32	.09375	55/64	.8593	1 5/8	1.6250	2 25/64	2.3906	3 5/16	3.3125
7/64	.10937	7/8	.8750	1 41/64	1.6406	2 13/32	2.4062	3 11/32	3.3437
1/8	.125	57/64	.8906	1 21/32	1.6562	2 27/64	2.4218	3 3/8	3.3750
9/64	.14062	29/32	.9062	1 43/64	1.6718	2 7/16	2.4375	3 13/32	3.4062
5/32	.15625	59/64	.9218	1 11/16	1.6875	2 29/64	2.4531	3 7/16	3.4375
11/64	.17187	15/16	.9375	1 45/64	1.7031	2 15/32	2.4687	3 15/32	3.4687
3/16	.1875	61/64	.9531	1 23/32	1.7187	2 31/64	2.4843	3 1/2	3.5000
13/64	.20312	31/32	.9687	1 47/64	1.7343	2 1/2	2.5000	3 17/32	3.5312
7/32	.21875	63/64	.9843	1 3/4	1.7500	2 33/64	2.5156	3 9/16	3.5625
15/64	.23437	1	1.0000	1 49/64	1.7656	2 17/32	2.5312	3 19/32	3.5937
1/4	.25	1 1/64	1.0156	1 25/32	1.7812	2 35/64	2.5468	3 5/8	3.6250
17/64	.26562	1 1/32	1.0312	1 51/64	1.7968	2 9/16	2.5625	3 21/32	3.6562
9/32	.28125	1 3/64	1.0468	1 13/16	1.8125	2 37/64	2.5781	3 11/16	3.6875
19/64	.29687	1 1/16	1.0625	1 53/64	1.8281	2 19/32	2.5937	3 23/32	3.7187
5/16	.3125	1 5/64	1.0781	1 27/32	1.8437	2 39/64	2.6093	3 3/4	3.7500
21/64	.32812	1 3/32	1.0937	1 55/64	1.8593	2 5/8	2.6250	3 25/32	3.7812
11/32	.34375	1 7/64	1.1093	1 7/8	1.8750	2 41/64	2.6406	3 13/16	3.8125
23/64	.35937	1 1/8	1.1250	1 57/64	1.8906	2 21/32	2.6562	3 27/32	3.8437
3/8	.375	1 9/64	1.1406	1 29/32	1.9062	2 43/64	2.6718	3 7/8	3.8750
25/64	.39062	1 5/32	1.1562	1 59/64	1.9218	2 11/16	2.6875	3 29/32	3.9062
13/32	.40625	1 11/64	1.1718	1 15/16	1.9375	2 45/64	2.7031	3 15/16	3.9375
27/64	.42187	1 3/16	1.1875	1 61/64	1.9531	2 23/32	2.7187	3 31/32	3.9687
7/16	.4375	1 3/64	1.2031	1 31/32	1.9687	2 47/64	2.7343	4	4.0000
29/64	.45312	1 7/32	1.2187	1 63/64	1.9843	2 3/4	2.7500	4 4/16	4.0625
15/32	.46875	1 5/64	1.2343	2	2.0000	2 49/64	2.7656	4 1/8	4.1250
31/64	.48437	1 1/4	1.2500	2 1/64	2.0156	2 25/32	2.7812	4 3/16	4.1875
1/2	.50	1 17/64	1.2656	2 1/32	2.0312	2 51/64	2.7968	4 1/4	4.2500
33/64	.5156	1 9/32	1.2812	2 3/64	1.0468	2 13/16	2.8125	4 15/16	4.3125
17/32	.5312	1 19/64	1.2968	2 1/16	2.0625	2 53/64	2.8281	4 3/8	4.3750
35/64	.5468	1 5/16	1.3125	2 5/64	2.0781	2 27/32	2.8437	4 7/16	4.4375
9/16	.5625	1 21/64	1.3281	2 3/32	2.0937	2 55/64	2.8593	4 1/2	4.5000
37/64	.5781	1 11/32	1.3437	2 7/64	2.1093	2 7/8	2.8750	4 9/16	4.5625
19/32	.5937	1 23/64	1.3593	2 1/8	2.1250	2 57/64	2.8906	5 5/8	4.6250
39/64	.6093	1 3/8	1.3750	2 9/64	2.1406	2 29/32	2.9062	4 11/16	4.6875
5/8	.6250	1 25/64	1.3906	2 5/32	2.1562	2 59/64	2.9218	4 3/4	4.7500
41/64	.6406	1 13/32	1.4062	2 11/64	2.1718	2 15/16	2.9375	4 13/16	4.8125
21/32	.6562	1 27/64	1.4218	2 3/16	2.1875	2 61/64	2.9531	4 7/8	4.8750
43/64	.6718	1 7/16	1.4375	2 13/64	2.2031	2 31/32	2.9687	4 15/16	4.9375
11/16	.6975	1 29/64	1.4531	2 7/32	2.2187	2 63/64	2.9843	5	5.0000
45/64	.7031	1 15/32	1.4687	2 15/64	2.2343	3	3.0000	5 1/8	5.1250
23/32	.7187	1 31/64	1.4843	2 1/4	2.2500	3 1/32	3.0312	5 1/4	5.2500
47/64	.7343	1 1/2	1.5000	2 17/64	2.2656	3 1/16	3.0625	5 3/8	5.3750
3/4	.7500	1 33/64	1.5156	2 9/32	2.2812	3 3/32	3.0937	5 1/2	5.5000
49/64	.7656	1 17/32	1.5312	2 19/64	2.2968	3 1/8	3.1250	5 5/8	5.6250
25/32	.7812	1 35/64	1.5468	2 5/16	2.3125	3 5/32	3.1562	5 3/4	5.7500
51/64	.7968	1 9/16	1.5625	2 21/64	2.3281	3 3/16	3.1875	5 7/8	5.8750
13/16	.8125	1 37/64	1.5781	2 11/32	2.3437	3 7/32	3.2187	6	6.0000

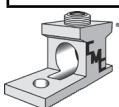

Wire Ranges

Size AWG-MCM	No. of Wires	Dia. Each Wire Inches	Dia. Inches	Clearance Drill	Present Clearance Between Conductor Dia. & Hole Dia.	Proposed or Suggested Drill Sizes for Wire Holes	Clearance Between Conductor & Proposed Drill Sizes
18	Solid	0.0403	0.0403	0.0469			
18	7	0.0403		0.0469			
16	Solid	0.0508	0.0508	0.0625			
16	7	0.0508		0.0625			
14	Solid	0.0641	0.0641	0.078			
14	7	0.0641		0.078			
12	Solid	0.0808	0.0808	0.098			
12	7	0.0808		0.098			
10	Solid	0.1019	0.1019	0.120			
10	7	0.1019		0.120			
8	Solid	0.1285	0.1285	0.156			
8	7	0.1285		0.156			
6	7	0.0612	0.184	0.219	0.035		
4	7	0.0772	0.232	0.250	0.018	0.265	0.033
3	7	0.0867	0.260	0.281	0.021	0.296	0.036
2	7	0.0974	0.292	0.312	0.020	0.328	0.036
1	19	0.0664	0.332	0.368	0.036		
0	19	0.0745	0.372	0.406	0.034		
00	19	0.0837	0.418	0.437	0.019	0.453	0.035
000	19	0.0940	0.470	0.500	0.030		
0000	19	0.1055	0.528	0.562	0.034		
250	37	0.0822	0.575	0.609	0.034	0.625	0.050
300	37	0.0900	0.630	0.656	0.026	0.687	0.057
350	37	0.0973	0.681	0.719	0.038	0.734	0.053
400	37	0.1040	0.728	0.781	0.053		
500	37	0.1162	0.813	0.875	0.062		
600	61	0.0992	0.893	0.938	0.045	0.953	0.060
700	61	0.1071	0.964	0.984	0.020	1.035	0.069
750	61	0.1109	0.998	1.035	0.037	1.062	0.064
800	61	0.1145	1.030	1.094	0.064		
900	61	0.1215	1.090	1.140	0.050	1.152	0.062
1000	61	0.1280	1.150	1.219	0.069	1.234	0.084
1250	91	0.1172	1.289	1.390	0.101	1.375	0.086
1500	91	0.1284	1.410	1.500	0.090		
1750	127	0.1174	1.526	1.593	0.067	1.625	0.099
2000	127	0.1255	1.630	1.697	0.057	1.734	0.104





We're here to support you.

Customer Service - 513-860-4455, press 2
Pricing/Quotations - 513-860-4455, press 3

TO ORDER:
cmorders@cmclugs.com

WWW.CMCLUGS.COM

Follow us on Social Media



February 2021

www.cmclugs.com

513.860.4455

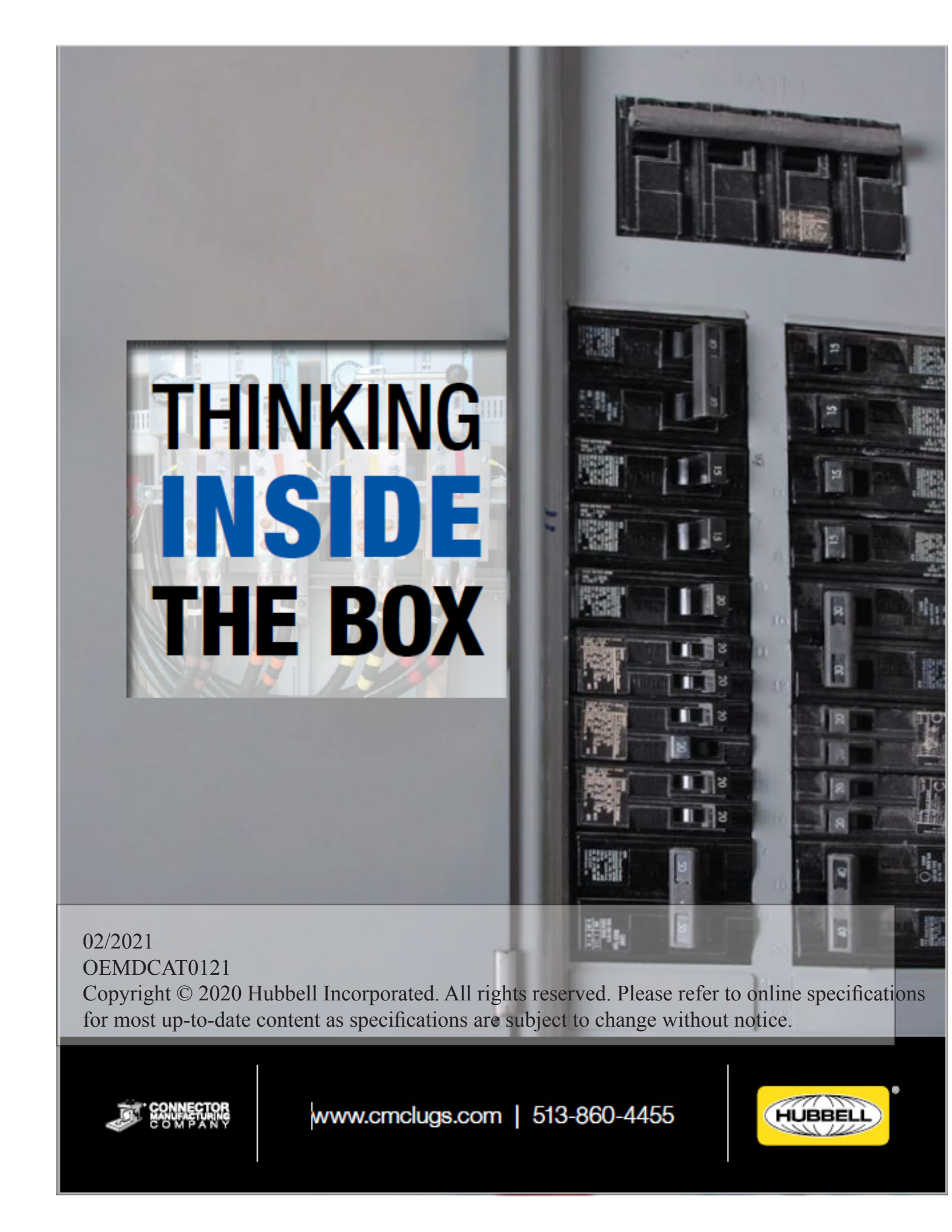

THINKING INSIDE THE BOX

02/2021

OEMDCAT0121

Copyright © 2020 Hubbell Incorporated. All rights reserved. Please refer to online specifications for most up-to-date content as specifications are subject to change without notice.



www.cmclugs.com | 513-860-4455



NOTES:

NOTES:

