

- ENCODER
- SWITCH
- POTENTIOMETER



■ Company profile

- **Founded in 1996**
- **Employees:706**
- **Factory area:** Plant 1# 12400 square meters/ Plant 2# 5200 square meters
- **System certification:** ISO9001、ISO/TS16949、ISO14001
- **Quality guideline:** Participation, Regulation, Performance, Superiority
- **Enviromental policy:** Energy saving, Environmental protection, Observing laws and regulations, Pollution Prevention

■ Product Type

- Encoders, Switches, Potentiometers
- Precise hardware, plastic part, die-casting accessories
- Glass-to-Metal Seals
- Ceramic-to-Metal Seals

■ Application

- Auto audio, Interphone, Instrument
- Multimedia audio, Home appliances, Medical equipments
- Communication equipment, Intelligent toy, Computer peripherals
- Smart home, Mechanical equipment, Bullet train
- Sensors

■ Core competitiveness

- Experienced R&D team
- Independent Automated Design and making
- Tooling Design and Making Team
- Self-manufactured for hardware,Plastic parts and die-casting accessories.



- Meet customized design
- Good quality
- High cost performance
- Perfect service
- Stable lead time

■ Corporate culture

- **Corporate vision:** Make profit for customer,employee,and society
- **Core values:** Intergrity, Team-work, Responsibility, Inplementation.
- **Mission:** To stand on LJV brand, To follow the path of virtue and let customers get used to choose LJV brand.
- **Work style:** Think, decide and do it.

Explanation of Part Number

Encoder explanation

RE 11 03 E C 1-H01-XXXX

①Product code ②Dimension ③Structure ④Bushing type ⑤Bracket code ⑥Rear cover ⑦Terminal type ⑧Serial number

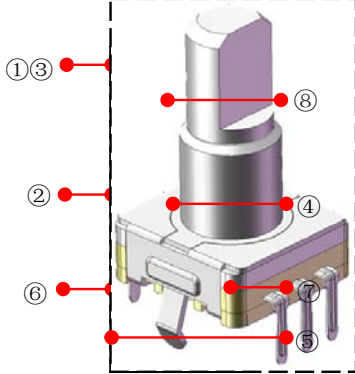

- ①Product code: RE-Rotary Encoder
- ②Outline Dimension: 8mm, 9mm, 10mm, 11mm, 12mm, 16mm, 18mm, 25mm, 28mm, 35mm etc.
- ③Structure: 01-thick type with push switch; 02-thin type without push switch; 03-thin type with push switch
- ④Bushing type: E-5mm long; F-7mm long; J-9mm long.....
- ⑤Bracket coder:A-2.5mm with 12.9mm space; B-2.5mm with 12.9mm space; C,D.....
- ⑥Rear cover: 1-rear cover without fixed leg; 2-with small fixed leg;3,4.....
- ⑦Terminal type: H-Pin horizontal/shaft is parallel to terminal; V-pin Vertical/shaft is vertical to terminal.
- ⑧Serial number: Including pulse, detent, shaft model etc.

Rotary switch explanation

RS 12 02 P2 S4 A A-V01-XXX

①Product code ②Dimension ③Structure ④Pole ⑤Position ⑥Bushing type ⑦Bracket code ⑧Terminal type ⑨Serial

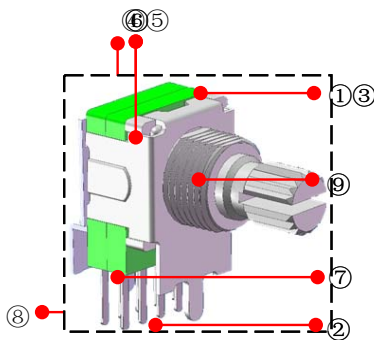

- ①Product code: RS-Rotary switch; PS-tact switch
- ②Outline Dimension: 06mm, 11mm, 12mm, 17mm
- ③Structure: 02-two channels; 03-three channels; 04-four channels.....
- ④Pole: P1-one pole; P2-two poles; P3, P4.....
- ⑤Position: S1-1 position; S2-2 position; S3,S4.....
- ⑥Busing type: A-5mm long; B-8mm long; X-no bushing etc.
- ⑦Bracket code: A-5mm; B=7mm; X=no bracket
- ⑧Terminal type: H-Pin horizontal/shaft is parallel to terminal; V-pin Vertical/shaft is vertical to terminal.
- ⑨Serial number: Including pulse, shaft model etc.

Potentiometer explanation

RP 08 110 SN A X -V01-XXXX

①Product code ②Dimension ③Structure ④Circuit coder ⑤Bushing type ⑥Bracket code ⑦Terminal type ⑧Serial n

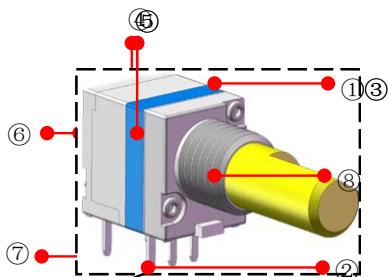











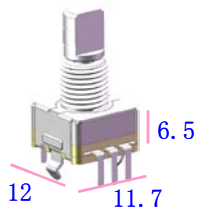

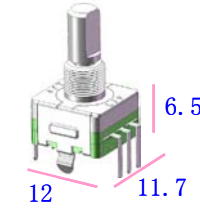

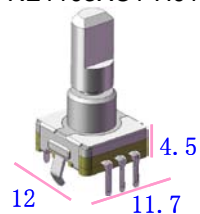
- ①Product code: Rotary potentiometer
- ②Outline Dimension: 08mm, 9mm, 11mm, 12mm, 14mm, 15mm, 16mm
- ③Structure: 110-single-unit, 120-dual unit
- ④Circuit coder: SN-single-unit with rotary switch; NO-single-unit without rotary switch; SG, GO.....
- ⑤Bushing type: A-5mm; E-7mm
- ⑥Bracket code: X-no bracket
- ⑦Terminal type: H-Pin horizontal/shaft is parallel to terminal; V-pin Vertical/shaft is vertical to terminal.
- ⑧Serial number: Including pulse, detent, shaft model etc.

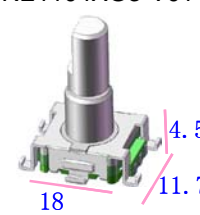

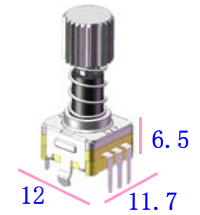

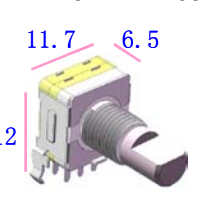

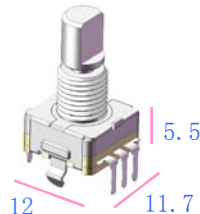



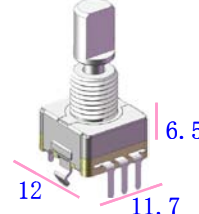

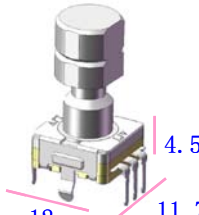

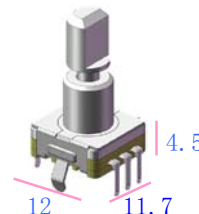
Icon Key

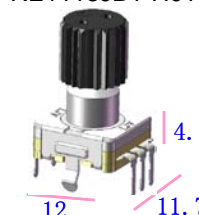
DVD	Persona Audio	Professional Walkie Audio	Health Care	Robot & Industrial machines	Meter	Home appliances	Navigation systems, Car AV	Automobiles

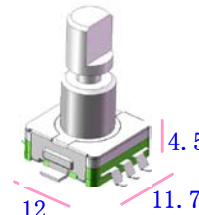
To lead green environmental protection and for detailed product information, go to: WWW.LJV.CN

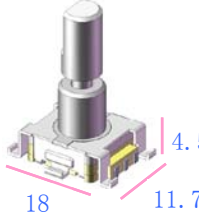
Encoder---RE11

Series	Specification	Application
RE1101XB1-H01 	.Feature: 6.5mm thick type with screw bushing .Output: Incremental type .Pulse/detent: 9/18,15/30, 20/20 .Push on switch: with/without .Push life: 20000/50000 cycles .Rotational life: 30000 cycles	
RE1101MD1-H01 	.Feature: IP67 rating and heavy rotational torque .Output: Incremental type .Pulse/detent: 8/16 .Push switch: with/without .Push life: 20000/50000 cycles .Rotation life:15000/30000 cycles	
RE1103XC1-H01 	.Feature: 4.5mm thin type w/o screw bushing .Output: incremental type .Pulse/detent: 9/18,15/30, 20/20,15/0,20/0 .Push switch: with/without .Push life: 20000/50000 cycles .Rotation life: 30000 cycles	
RE1104XG3-V01 	.Feature: 4.5mm thin type with SMT .Output: incremental type .Pulse/detent: 9/18,15/30, 20/20 .Push switch: with/without .Push life: 20000/50000 cycles .Rotation life: 30000cycles	
RE1105GB1-H01 	.Feature: Push-lock mechanism .Output: Incremental type .Pulse/detent:15/30 .Push switch: with .Push life:20000 cycles .Rotation life: 30000 cycles	
RE1107XM1-V03 	.Feature: vertical pins with IP67 rating .Output: incremental type .Pulse/detent:9/18,15/30, 20/20 .Push switch: with/without .Push life: 20000 cycles .Rotation life: 15000/30000 cycles .IP rating: IP67	
RE1109XE1-H01 	.Feature: 5.5mm thick type with screw bushing .Output: incremental type .Pulse/detent: 9/18,15/30, 20/20 .Push switch: with/without .Push life: 20000/50000cycles .Rotation life: 30000 cycles	

Series	Specification	Application
RE1111XB1-H01 	.Feature: 6.5mm thick type with long travel and good feeling. Output: Incremental type. .Pulse/detent: 9/18,15/30, 20/20 .Push on switch:1.5mm travel .Push life: 20000 cycles .Rotation life: 30000 cycles	
RE1113JA1-H01 	.Feature: Europe safety structure, minimized shaft wobble type and good feeling. .Output: Incremental type .Pulse/detent: 9/18,15/30, 20/20,15/0, 20/0 .Push life: 20000 cycles .Rotation life: 30000 cycles	
RE1113XC1-H01 	.Feature: thin type with long travel (1.5mm) and good feeling. .Output: incremental type .Pulse/detent:9/18,15/30, 20/20,15/0,20/0 .Push life:20000 cycles .Rotation life: 30000 cycles	
RE1113JB1-H01 	.Feature: thin type with minimized shaft wobble type and good feeling. .Output: Incremental type .Pulse/detent: 9/18,15/30, 20/20 .Push life: 20000cycles .Rotation life: 30000 cycles	
RE1113XF2-V01 	.Feature: thin type with long travel and good feeling. .Output: incremental type .Pulse/detent: 9/18,15/30, 20/20 .Push switch: with/without .Push life: 20000 cycles .Rotation life: 30000 cycles	
RE1113XG3-V01 	.Feature: thin type,long travel push switch and SMT type .Output:incremental type .Pulse/detent: 9/18,15/30, 20/20 .Push switch: 1.5mm long travel .Push life: 20000 cycles .Rotation life: 30000 cycles	
RE1121AB1-H01 	.Feature: dual shaft with long bushing .Output: incremental type .Pulse/detent: 9/18,15/30, 20/20,15/0,20/0 .Push switch: with/without .Push life: 20000/50000 cycles .Rotation life: 30000 cycles	

Encoder---RE12/RE16/RE25/RE28/RE35/RE08

Series	Specification	Application
RE1201XE1-H01 	.Feature: Horizontal pins with through hole .Output: incremental type .Pulse/detent: 12/12,12/24, 24/24,12/0,24/0 .Push switch: with/without .Push life: 20000 cycles .Rotation life: 30000 cycles	
RE1201XI2-V01 	.Feature: hand soldering with surface mounting .Output: incremental type .Pulse/detent: 12/12,12/24, 24/24,12/0,24/0 .Push switch: with/without .Push life: 20000 cycles .Rotation life: 30000 cycles	
RE1201XH1-V02 	.Feature: PC pin vertical/down facing .Output: incremental type .Pulse/detent: 12/12,12/24, 24/24,12/0,24/0 .Push switch: with/without .Push life: 20000 cycles .Rotation life: 30000 cycles	
RE1203XC1-H01 	.Feature: screw bushing,metal shaft with minimized shaft wobble .Output: incremental type .Pulse/detent:12/12,12/24, 24/24,12/0,24/0 .Push switch: with/without .Push life, 20000 cycles .Rotation life: 30000 cycles	
RE1600XA1-H01 	.Feature:Horizontal pins with through hole .Output: incremental type .Pulse/detent: 12/12,12/24, 24/24 .Push switch: with/without .Push life: 30000 cycles .Rotation life: 30000 cycles	
RE1601XB1-H01 	.Feature: metal shaft, horizontal pins with through hole .Output: incremental type .Pulse/detent: 12/12,12/24, 24/24 .Push switch: with/without .Push life: 30000 cycles .Rotation life: 30000 cycles	
RE1800XX1-H01 	.Feature: IP67 rating, 6 pins and heavy rotational torque .Output: incremental type .Pulse/detent:10/10,12/12, 16/16, 20/20, 24/24 .Push switch: without .Rotation life: 15000/30000 cycles	

Series	Specification	Application
RE2500XA-H01 	.Feature: hollow shaft with detent .Output: incremental type .Pulse/detent: 10/10,10/20 .Rotaton life: 30000 cycles	
RE2800XA-H01 	.Feature: hollow shaft with minimized shaft wobble .Output: incremental type .Pulse/detent: 9/18,15/30 .Rotation life: 30000 cycles	
RE2801XB-H01 	.Feature: thin type, hollow shaft with minimized shaft wobble .Output: incremental type .Pulse/detent:15/30 .Rotation life: 30000 cycles	
RE3500XA-H01 	.Feature: thin type, hollow shaft with minimized shaft wobble .Output: incremental type .Pulse/detent:16/32 .Rotation life: 30000 cycles	
RE3501XB-H01 	.Feature:thin type, hollow shaft with minimized shaft wobble .Output: ABC switch .Pulse/detent: 10xABC/30 .Rotation life: 30000 cycles	
RE08110XX-V01 	.Feature: 8mm size with single-unit .Output: incremental type .Pulse/detent:10/20 .Rotation life: 15000/30000 cycles .IP rating: IP67	
RE08120XX-V01 	.Feature: 8mm size with dual-unit .Output: absolute .Pulse/detent: 16/16 .Rotation life: 15000/30000 cycles .IP rating: IP67	

Encoder---RE08/RE09/RE10

Series	Specification	Application
RE08115XX-V01 	.Feature:8mm size with push on switch .Output: incremental type .Pulse/detent:10/20 .Push life: 20000 cycles .Rotation life: 15000/30000 cycles .IP rating: IP67	
RE08140XX-V02 	.Feature: 8mm size with four-unit .Output: absolute .Pulse/detent:16/16 .Rotation life: 15000/30000 cycles .IP rating: IP67	
REP08120XX-V02 	.Feature: dual-shaft, encoder with potentiometer; IP67 rating .Output: Incremental-outside shaft, resistance-inside shaft .Pulse/detent: 10/20 for outside shaft .Push switch: with/without .Rotation life: 15000/30000 cycles	
RE09101XA-H01 	.Feature: Horizontal pins with push on switch; IP67 rating .Output: incremental type .Pulse/detent: 10/20 .Push switch: with/without Push life: 20000 cycles .Rotation life: 15000/30000 cycles	
RE09101XB-V01 	.Feature: PC pin vertical/down facing with push switch .Output: incremental type .Pulse/detent: 10/20 .Push life: 20000 cycles .Rotation life:15000/30000 cycles .IP rating: IP67	
RE1002BA-V01 	.Feature: high rotational torque .Output: absolute/incremental .Pulse/detent: 3/3, 4/4, 16/16, 9/18 .Rotational angle: 18°,20° .Rotation life: 15000/30000 cycles .IP rating: IP67	
RP08110SNAX-V01 	.Feature: 8mm size with rotational switch .Max. operating voltage: 50V AC 10V DC .Rotational angle: 300±5° .Rotation life: 15000/30000 cycles .IP rating: IP67	

Potentiometer---RP08/RP09/RP11/RP12/RP15

Series	Specification	Application
RP08120GOXX-V01 	.Feature:8mm size with dual-unit .Max. operating voltage: 50V AC 10V DC .Rotational angle: 300±5° .Rotation life:15000/30000 cycles .IP rating: IP67	
RP09110NOXX-H01 	.Feature: horizontal pins .Max. operating voltage: 50V AC 10V DC .Rotational angle: 300±5° .Push/rotational switch: with/without .Rotation life:15000/30000 cycles	
RP09110SGXX-V01 	.Feature: PC pin vertical/down facing .Max. operating voltage: 50V AC 20V DC .Rotational switch: with/without .Rotational angle: 300±5° .Rotation life: 15,000 cycles .IP rating: IP67	
RP09110GPLX-V01 	.Feature: Push-lock mechanism .Max. operating voltage: 50V AC 20V DC .Push-lock mechanism without detent .Rotational angle: 300±5° .Rotation life: 10000 cycles	
RP1100GOXX-H01 	.Feature:11mm size .Terminal: horizontal/vertical .Max. operating voltage: 50V AC 20V DC .Rotational angle: 300±5° .Rotation life: 10000 cycles	
RP1231SGXX-VX 	.Feature:12mm size with rotational switch .Max. operating voltage: 50V AC 20V DC .Rotational angle:300±5° .Rotation life:10000 cycles	
RP1500XA1-H01 	.Feature: span type potentiometer .Max. operating voltage: 250V AC 125V DC .Rotational angle: 265±5° .Rotation life: 10000 cycles	

Self-return/multi-position---RS11/RS12/RS17

Series	Specification	Application
RS1111XC1-H01 	.Feature:self-return switch and minimized shaft wobble .Output: self-return from left 45° to right45° .Push switch: with/without .Push life: 20000 cycles .Rotation life:15000 cycles	
RS1111XC1-H01 	.Feature: self-return .Output: self-return from left 45° to right45° .Push switch: with/without .Push life: 20000 cycles .Rotation life:15000 cycles	
RS1202P2SXAB-V02 	.Feature: high rotational torque .Output: multi-position switch .Poles/position:1/6,2/6, 3/6,4/6 .Rated power: 0.3A 16V DC .Rotational angle: 30±3° .Rotation life: 10000 cycles	
RS1700P1SXCA-H01 	.Feature:high rotational torque .Output: multi-position switch .Poles/position:1/2-8, 2/2-8 .Rated power: 0.3A 16V DC .Rotational angle: 30±3°/60±3° .Rotation life: 10000 cycles	

Tact Switch---PS06

Series	Specification	Application
PS0601P1S1XX-V01 	.Feature: soft feeling typ with SMT .Operating force: 1.57N,2.45N, 2.94N .Push life: 100000 cycles .Travel: 1.3mm .Operating resistance: 50mΩ Max.	
PS0602P1S1XX-V01 	.Feature: soft feeling typ with SMT .Operating force:1.57N .Push life:100000 cycles .Travel: 1.0mm .Operating resistance: 50mΩ Max.	
PS0603P1S1XX-V03 	.Feature: surface mounted .Operating force: 2.5N .Push life: 50000 cycles .Travel: 0.3mm .Operating resistance: 50mΩ Max.	
PS0603P1S1XX-V02 	.Feature: SMT type with bracket .Operating force: 2.5N .Push life: 50000 cycles .Travel: 0.3mm .Operating resistance: 50mΩ Max.	

Metal stamping and plastic injection parts

Metal stamping parts 	Metal stamping parts 	Plastic cover hardware
Plastic parts 	Plastic parts 	Plastic cover hardware
Die-casting parts 	Die-casting parts 	Plastic cover hardware

Precision sealing products

A10 tube cap 	T03 tube holdert 	T0 tube cap
Black Porcelain tube 	UM base 	T039
Relay base 	3627 base 	Protector base



东莞市林积为实业投资有限公司
Donguan LJV Industrial Investment Co.,LTD

<http://www.LJV.cn>

Address: Yuquan Electronic Information Industrial Park,
Fenggang Town,Dongguan City,Guangdong,China

TEL: 0086-0769-82100188

FAX: 0086-0769-82100199

Service Hotline: 400-064-0188

Navigation: LJV