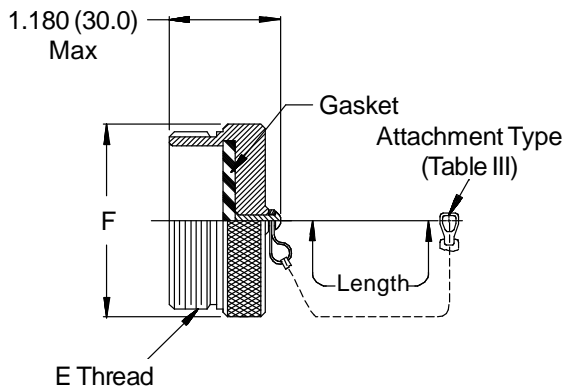
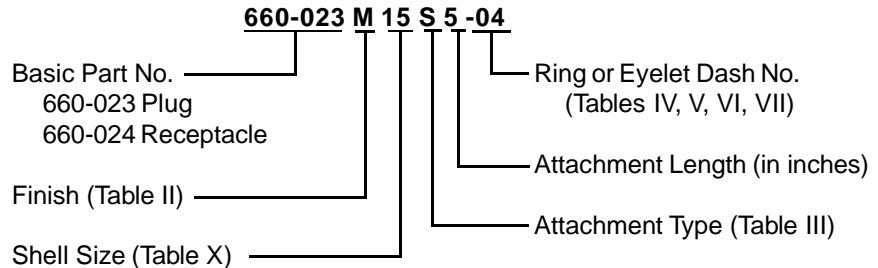
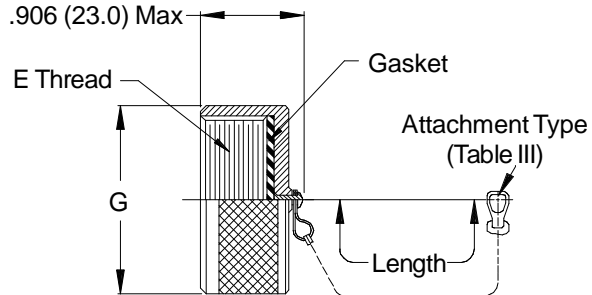

**MIL-C-38999**  
**Series III**

**660-023 Plug Cover**

**660-024 Receptacle Cover**
**TABLE X: SHELL SIZE DIMENSIONS**

Shell Size	Shell Size Code Ref.	E Thread	F Max	G Max
09	A	.6250-0.1P-0.3L-TS	.906 (23.0)	.906 (23.0)
11	B	.7500-0.1P-0.3L-TS	1.024 (26.0)	1.102 (28.0)
13	C	.8750-0.1P-0.3L-TS	1.220 (31.0)	1.220 (31.0)
15	D	1.0000-0.1P-0.3L-TS	1.300 (33.0)	1.260 (32.0)
17	E	1.1875-0.1P-0.3L-TS	1.457 (37.0)	1.457 (37.0)
19	F	1.2500-0.1P-0.3L-TS	1.575 (40.0)	1.535 (39.0)
21	G	1.3750-0.1P-0.3L-TS	1.732 (44.0)	1.654 (42.0)
23	H	1.5000-0.1P-0.3L-TS	1.811 (46.0)	1.772 (45.0)
25	J	1.6250-0.1P-0.3L-TS	1.969 (50.0)	1.929 (49.0)

See inside back cover fold-out or page 14 for Table II.

Metric dimensions (mm) are indicated in parentheses.

**660-023 (Plug) - 660-024 (Receptacle)**  
**Protective Covers**  
**MIL-C-38999 Series III Threaded**



**66 & 78**

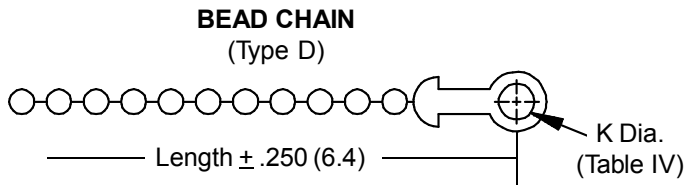
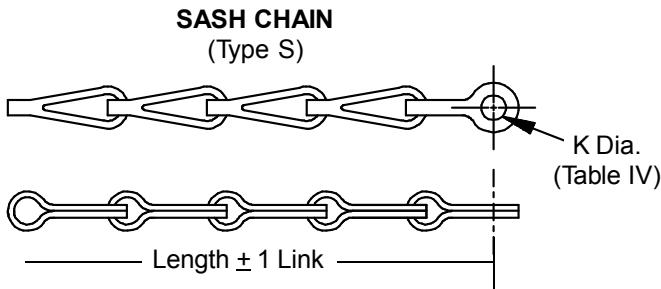
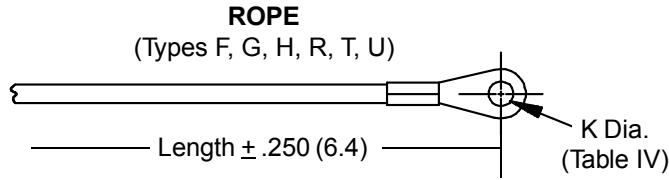
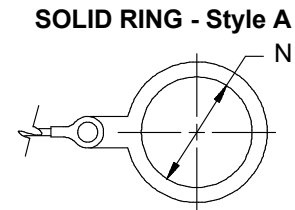
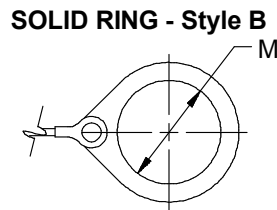
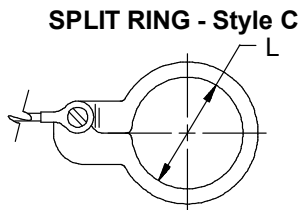

**TABLE III: ATTACHMENT**

Sym	Attachment Type
D	Bead Chain, Cres., Passivate
F	Wire Rope, Nylon Jacket
G	Nylon Rope
H	Wire Rope, Teflon Jacket
N	No Attachment
R	Wire Rope, PVC Jacket
S	#8 Sash Chain, Cres., Passivate
T	Wire Rope, No Jacket
U	Wire Rope, Polyurethane Jacket with Terminal

**TABLE IV: EYELET**

Dash No.	K DIA
01	.140 (3.6)
02	.182 (4.6)
03	.191 (4.9)
04	.197 (5.0)
05	.167 (4.2)
06	.125 (3.2)
07	.218 (5.5)
09	.156 (4.0)
00	No Eyelet



**TABLE V: SPLIT RING STYLE C**

Dash No.	L Dia. ±.015 (0.4)	Dash No.	L Dia. ±.015 (0.4)
50	.425 (10.8)	74	1.625 (41.3)
52	.485 (12.3)	76	1.750 (44.5)
54	.640 (16.3)	78	1.875 (47.6)
56	.750 (19.1)	80	1.980 (50.3)
58	.890 (22.6)	82	2.060 (52.3)
60	1.015 (25.8)	84	2.235 (56.8)
62	1.095 (27.8)	86	2.310 (58.7)
64	1.130 (28.7)	88	2.475 (62.9)
66	1.250 (31.8)	90	2.655 (67.4)
68	1.350 (34.3)	92	2.810 (71.4)
70	1.390 (35.3)	94	3.045 (77.3)
72	1.485 (37.7)		

**TABLE VI: SOLID RING STYLE B**

Dash No.	M Dia. ±.015 (0.4)	Dash No.	M Dia. ±.015 (0.4)
08	.468 (11.9)	24	1.484 (37.7)
10	.593 (15.1)	25	1.577 (40.1)
12	.718 (18.2)	27	1.640 (41.7)
13	.765 (19.4)	28	1.687 (42.8)
14	.844 (21.4)	29	1.765 (44.8)
15	.890 (22.6)	30	1.890 (48.0)
16	.968 (24.6)	31	1.953 (49.6)
17	1.015 (25.8)	32	1.968 (50.0)
18	1.093 (27.8)	33	2.077 (52.8)
19	1.140 (29.0)	35	2.140 (54.4)
20	1.203 (30.6)	36	2.187 (55.5)
21	1.265 (32.1)	40	2.406 (61.1)
22	1.343 (34.1)	44	2.656 (67.5)
23	1.453 (36.9)	48	3.031 (77.0)
		118	.310 (7.9)

**TABLE VII: SOLID RING STYLE A**

Dash No.	N Dia. ±.015 (0.4)	Dash No.	N Dia. ±.015 (0.4)
095	.312 (7.9)	109	1.266 (32.2)
100	.391 (9.9)	209	1.312 (33.3)
101	.516 (13.1)	110	1.438 (36.5)
102	.583 (14.8)	210	1.438 (36.5)
103	.641 (16.3)	111	1.521 (38.6)
104	.708 (18.0)	211	1.536 (39.0)
105	.766 (19.5)	112	1.641 (41.7)
205	.788 (20.0)	113	1.766 (44.9)
106	.896 (22.2)	213	1.812 (46.0)
206	.907 (23.0)	114	1.891 (48.0)
107	1.016 (25.8)	214	1.938 (49.2)
207	1.025 (26.0)	115	2.078 (52.8)
108	1.141 (29.0)	116	2.406 (61.1)
308	1.188 (30.2)	117	2.510 (63.8)
208	1.203 (30.6)		

# Mouser Electronics

Authorized Distributor

Click to View Pricing, Inventory, Delivery & Lifecycle Information:

## Glenair:

[660-024B15G3-01-372](#) [660-023B13R5-01](#) [660-023NF15S5-15](#) [660-024NF15S5-15](#) [660-024Z115N](#) [660-023B25S7-05](#) [660-024M15S3-308](#) [660-024N09S2-01](#) [660-024M13G3-01](#) [660-024M21H5-111](#) [660-024NF11H5-54](#) [660-023B09F5-54](#) [660-023B09S6-05](#) [660-023B11D4-12](#) [660-023B11R5-09](#) [660-023B11R5-10](#) [660-023B11R8-04](#) [660-023B13F6-50](#) [660-023B13G5-13](#) [660-023B13R6-105-136](#) [660-023B13S3-02](#) [660-023B13S6-01](#) [660-023B15R8-04](#) [660-023B15S6-01](#) [660-023B15S6-02](#) [660-023B17F11-237](#) [660-023B17N](#) [660-023B17R6-01](#) [660-023B17R8-04](#) [660-023B17S6-01](#) [660-023B19S6-01](#) [660-023B19S6-02](#) [660-023B21F6-110](#) [660-023B23R6-110-136](#) [660-023B23S5-01](#) [660-023B23S5-04](#) [660-023B23S6-01](#) [660-023B25D5-05](#) [660-023B25F8-02](#) [660-023B25S6-02](#) [660-023B25S9-02](#) [660-023C19S3-00](#) [660-023C19U6-108](#) [660-023M09G5-01](#) [660-023M09N](#) [660-023M09S5-04](#) [660-023M11F5-01](#) [660-023M11H5-106](#) [660-023M11H5-54](#) [660-023M11H6-06](#) [660-023M11H6-54](#) [660-023M11R4-103](#) [660-023M11R5-04](#) [660-023M11S5-01](#) [660-023M11S5-103](#) [660-023M13F6-05](#) [660-023M13G4-05](#) [660-023M13G6-01](#) [660-023M13H5-12](#) [660-023M13H5-56](#) [660-023M13H6-01-288](#) [660-023M13N](#) [660-023M13R4-105](#) [660-023M13R5-04](#) [660-023M13S5-02](#) [660-023M13S6-06](#) [660-023M15F4-01](#) [660-023M15F5-58](#) [660-023M15F5-60](#) [660-023M15G4-05](#) [660-023M15H4-05](#) [660-023M15H5-01](#) [660-023M15N](#) [660-023M15N-142](#) [660-023M15R5-04](#) [660-023M15S5-106](#) [660-023M15S6-06](#) [660-023M15S8-01](#) [660-023M17F4-01](#) [660-023M17F5-60](#) [660-023M17H5-01](#) [660-023M17H5-05](#) [660-023M17H5-17](#) [660-023M17H5-60](#) [660-023M17H6-01](#) [660-023M17H6-06](#) [660-023M17H6-207](#) [660-023M17N](#) [660-023M17R3-60](#) [660-023M17R5-04](#) [660-023M17R5-17](#) [660-023M17S5-04](#) [660-023M17S5-107](#) [660-023M17S5-108](#) [660-023M17S6-06](#) [660-023M19H6-19](#) [660-023M19N](#) [660-023M19R5-04](#) [660-023M21D4-23](#) [660-023M21F5-21](#)