



AIRCRAFT PRESSURE TRANSDUCER

APT-20-1000 (100mV Output)

APTE-6-1000 (5V Output)*

- High Natural Frequencies
- Unprecedented Stability And Reliability To High Temperatures
Ruggedized Internal Construction
- Leakproof, All Welded Construction
No Leak After Exposure To 2000°F (1093°C)
- Utmost In Safety
Secondary Containment Of Pressure Media
- Fully Qualified
Passed Extensive Environmental Tests
- FAA Authorization TSO-C47 (Consult Factory on Pressure Ranges)
- FAA Manufacturer's Maintenance Facility



SPECIFICATIONS	UNAMPLIFIED APT-SERIES	AMPLIFIED APTE SERIES
Excitation	10VDC Regulated	28VDC ± 4V
Output	0 - 100mV	0 - 5VDC Diff. or 0.5 - 5VDC Single Ended
Power Consumption	100mW (Typ.)	280mW (Typ.)
Input Impedance	1000 Ohms (Min.)	N/A
Output Impedance	2000 Ohms (Max.)	100 Ohms (Max.)
Operating Temperature Range	-65°F to +300°F (-55°C to +150°C)	-65°F to +250°F (-55°C to +120°C)
Weight Gage and Absolute Versions	0.3 Lb. (Max.)	0.37 Lb. (Max.)
Case Outline Gage and Absolute Versions	Case Length May Vary With Measuring Mode	
Construction Materials	316 SS And 17-4 PH SS	
Pressure Range	To Specification 0-15 PSI to 0-5000 PSI (0-1.0 BAR to 0-350 BAR) (Typ.)	
Proof Pressure	2 Times Rated Pressure Range	
Burst Pressure	3 Times Rated Pressure Range Up to 10,000 PSI	
Insulation Resistance	100 Megohms Min. @ 50VDC	
Mounting Torque	75 Inch-Pounds (Max.)	
Total Error Band	Includes Linearity, Hysteresis, Repeatability, Mounting Error and Vibration Effects, Thermal Errors Within The Compensated Temperature Range, As Well As Normalization Errors of Zero and Full Scale. (See Fig I and II For Typical Cases)	
Resolution	Infinitesimal	
MTBF	At Least 30,000 Hours	
Fluid Temperature	-65°F to +300°F (-55°C to +150°C)	
Altitude-Operating	Unaffected	
Media Compatability	JP-4 and JP-5 Grade Aviation Turbine Fuel Per MIL-T-5624, Hydraulic Fluid Per MIL-H-5606, MIL-H-83282, Engine and Transmission Lubrication Oil Per MIL-L-7808 and MIL-L-23699 and Aviation Gasoline Per MIL-G-5572 All Grades	
Humidity	100% Relative Humidity	
Acceleration	Operational After Being Subjected to "G" Levels of 12 "G"s Per MIL-STD-810C, Method 513.2 Procedure 1	
Linear Vibration	20g Peak, Sine 10 to 2000 Hz	
Mechanical Shock	20g half Sine Wave 11 msec. Duration	
Electromagnetic Interference	APTE SERIES: Meets RTCA DO-160 Sections 18, 19 and 21 All Cat. A, Section 20 Cat. U. (With Shielded Cable)	
Electrical Spike Protection	APTE SERIES: Unit Satisfies Power Input and Voltage Spike Conducted DO-160 Sections 16 and 17. Power Input Test 16 Voltage Spike Conducted Test 17	

Note: Custom pressure ranges, accuracies and mechanical configurations available. Dimensions are in inches. Dimensions in parenthesis are in millimeters. All dimensions nominal. (J) Continuous development and refinement of our products may result in specification changes without notice. Copyright © 2014 Kulite Semiconductor Products, Inc. All Rights Reserved.

TYPICAL ERROR BAND

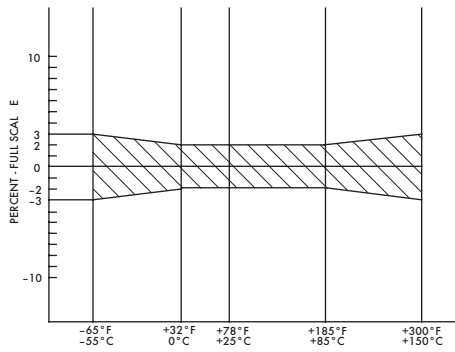

FIG I: TYPICAL ERROR BAND - UNAMPLIFIED UNIT

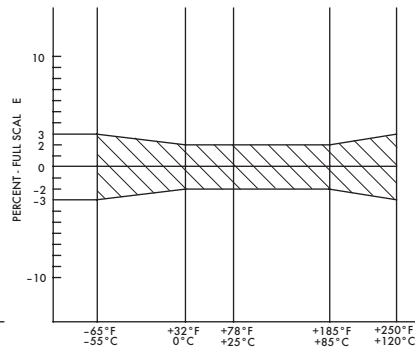
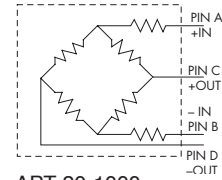

FIG II: TYPICAL ERROR BAND - AMPLIFIED UNIT

WIRING

0 - 100 mV OUTPUT



APT-20-1000

3 WIRE 0.5 - 5V OUTPUT

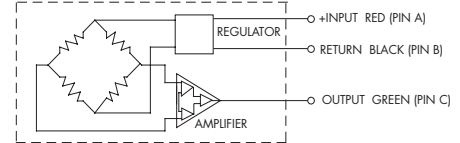

APTE-6-1000-XXXA/G-3

4 WIRE 0 - 5V OUTPUT

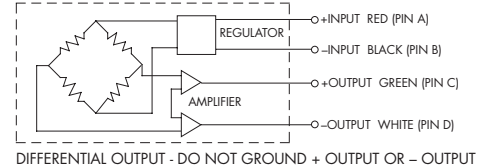

DIFFERENTIAL OUTPUT - DO NOT GROUND + OUTPUT OR - OUTPUT

APTE-6-1000-XXXA/G-4

*** Ordering Information**

3 Wire:
APTE-6-1000-XXXA/G-3
4 Wire:
APTE-6-1000-XXXA/G-4

**APT-20-1000-XXX SERIES
TYPICAL UNAMPLIFIED VERSION**

ABSOLUTE, SEALED GAGE

VENTED GAGE

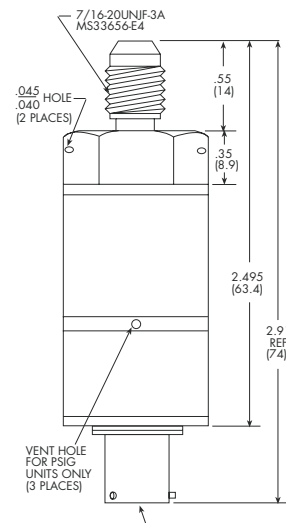
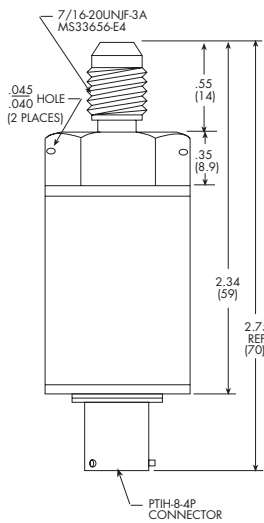
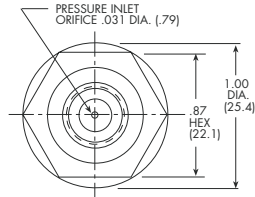
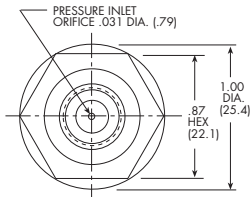

ALL DIMENSIONS TYPICAL

**APTE-6-1000-XXX SERIES
TYPICAL AMPLIFIED/REGULATED VERSION**

ABSOLUTE, SEALED GAGE

VENTED GAGE

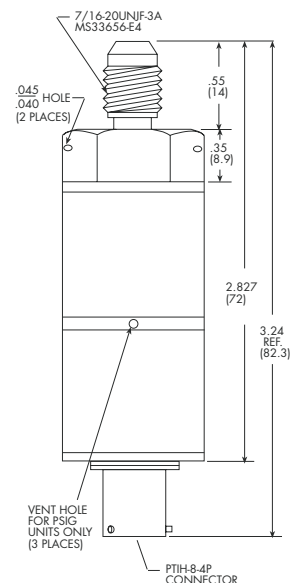
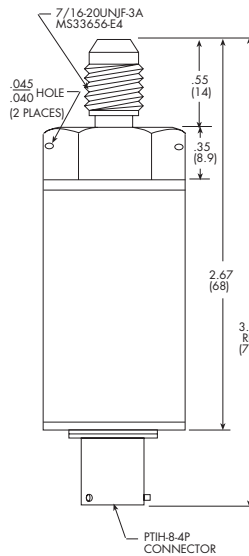
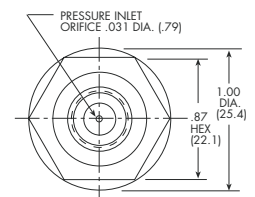
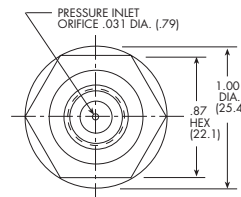

ALL DIMENSIONS TYPICAL

Note: Custom pressure ranges, accuracies and mechanical configurations available. Dimensions are in inches. Dimensions in parenthesis are in millimeters. All dimensions nominal. (J) Continuous development and refinement of our products may result in specification changes without notice. Copyright © 2014 Kulite Semiconductor Products, Inc. All Rights Reserved.