

Specification:

*Contact Resistance:

- (1)30m Ohm Max. at 100mA
- (2)10,000 Cycles After: 40m Ohm Max.at 100mA

*Rated Voltage: AC 30V

*Contact Current Rating:

- (1)Signal Line: 1A/Pin (No. 1 to 5)
- (2)2-Line For Power: 1.8A/Pin(No. 1 and 5),0.5A/Pin(No. 2 to 4)

*Insulation Resistance: 100M Ohm Min. At 500V DC

*Dielectric Withstanding Voltage: 100V AC for 1 Minute

*Durability (Life Test): 10,000 Cycles

*Insertion Force: 35 Newton Maximum

*Extraction Force: 8 Newton Minimum

*Operating Temperature: -30°C to +85°C

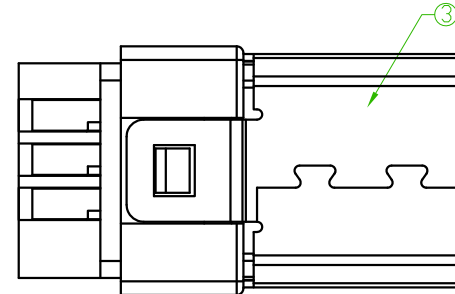
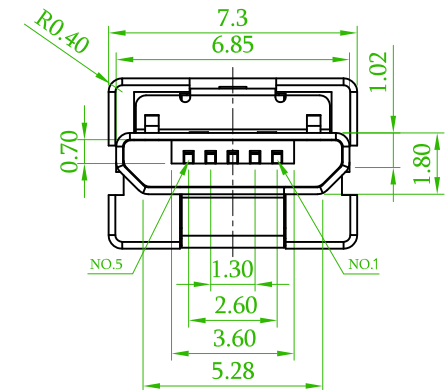
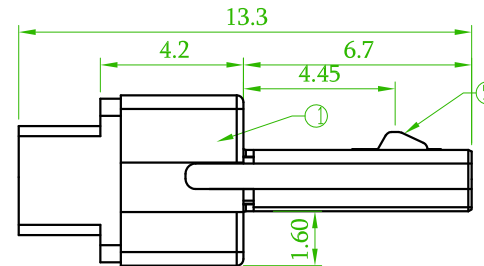
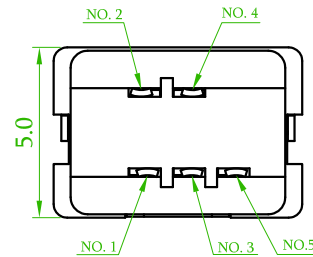
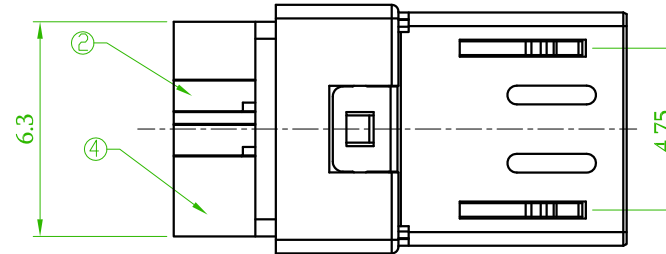
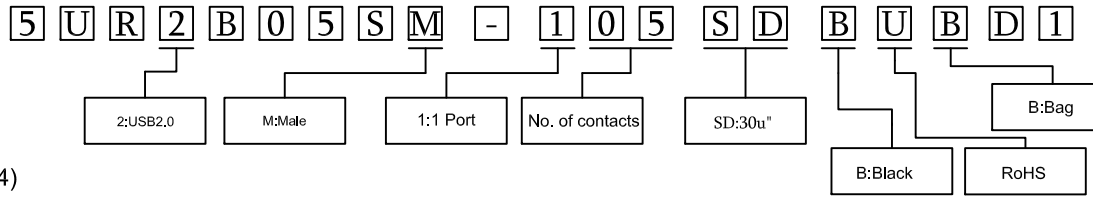

*Solderability: 260°C ±5°C;5 Sec

ORDER INFORMATION



Old Part No. :MIUSB-M5S2B-U

NO.	NAME	MATERIAL	FINISH	Q'TY	REMARK
1	HOUSING	LCP+GF30%	BLACK	1	
2	PIN TERM.	PBS T:0.20	GOLD/TIN PLATED	5	Ni:80~120u"; Gold:30u" Tin:120~200u"
3	SHELL	STAINLESS T:0.20	NICKEL PLATED	1	NI:50u" MINIMUM.
4	COVER	LCP+GF30%	BLACK	1	
5	SPRING	STAINLESS T:0.40		1	

 耀德精密有限公司 Amtek Technology Co., Ltd. TEL: 886-2-2260-6878 FAX: 886-2-2260-8030	品名 TITLE	MICRO USB B TYPE MALE SOLDER 5P			頁數 Page	1/1
	品號 PART NO.	5UR2B05SM-105SDBUBD1			繪圖 DRAWN	Mia 2015/09/15
	圖號 DRAWING NO.		版本 REV.	B	核對 CHECKED	John 2015/09/15
	客戶品號 CUSTOMER P/N		比例 SCALE	None	承認 APPROVED	John 2015/09/15
	公差 TOLERANCE	.X ± 0.25 .XX ± 0.13	單位 UNIT	mm	THIRD ANGLE PROJECTION	

REV.	ECN NO. OR DESCRIPTION	REVISED	DATE
1	1. Revised the Drawing 2. Revised the Part No. :5UR2B05SM-105G0BUBD1->5UR2B05SM-105SDBUBD1	B	2016/07/21 Jeff