

## Female Header 2.0mm 1 Row H=2.0mm Bottom Entry SMT Type

### Specifications

Current Rate:2.0 AMP  
 Insulation Resistance:1000MΩ Min.  
 Contact Resistance:20mΩ Max.  
 Dielectric Voltage:500V AC for one minute  
 Operation Temperature:-40°C to +105°C

### Material

Insulator:Polyester,UL 94V-0  
 ©Standard:Nylon 6T  
 Terminal:Copper Alloy  
 Plating:Gold Plated

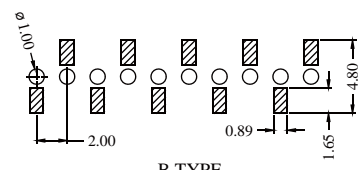
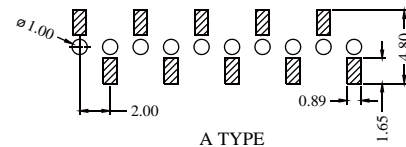
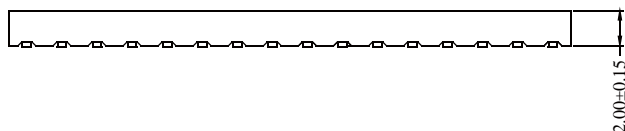
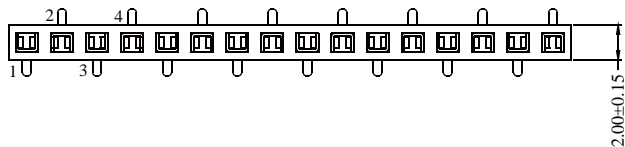
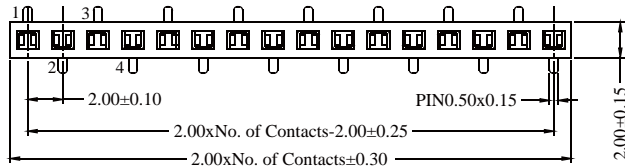
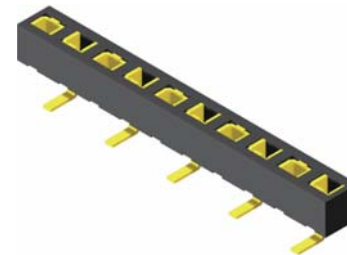

Recommended P.C.B Layout(Bottom Enter)  
 (PCB BOARD TOLERANCE±0.05)

Part No.:PS2BM20-1XX-U

## Female Header 2.0mm 2 Row H=2.0/2.7mm Bottom Entry SMT Type

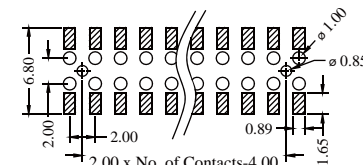
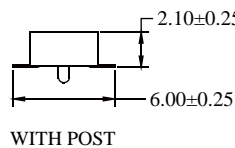
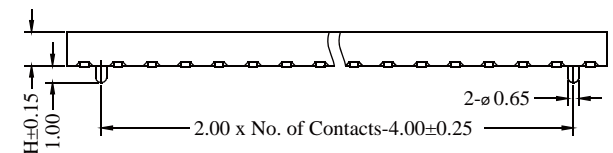
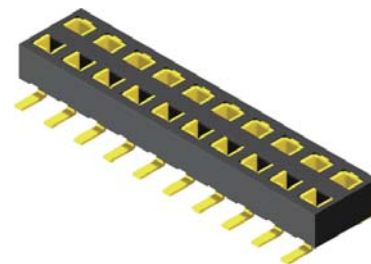
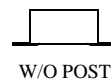
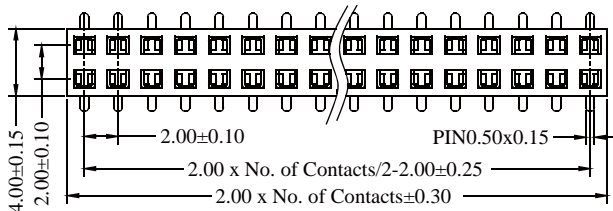

Recommended P.C.B Layout(Bottom Enter)  
 (PCB BOARD TOLERANCE±0.05)

Part No.:PS2BM20/27-2XX-U

## ORDER INFORMATION

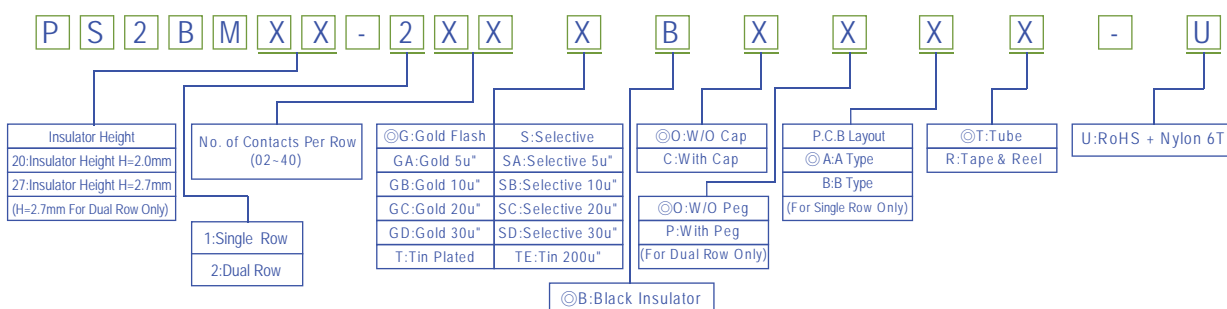

©:Standard Recommended