



NPN SILICON RF TRANSISTOR NE894M13 / 2SC5787

NPN SILICON RF TRANSISTOR FOR HIGH-FREQUENCY LOW NOISE 3-PIN LEAD-LESS MINIMOLD

FEATURES

- Ideal for 3 GHz or higher OSC applications
- Low noise, high gain
 $f_T = 20$ GHz TYP., $|S_{21e}|^2 = 13$ dB TYP. @ $V_{CE} = 1$ V, $I_C = 20$ mA, $f = 2$ GHz
NF = 1.4 dB TYP. @ $V_{CE} = 1$ V, $I_C = 5$ mA, $f = 2$ GHz, $Z_S = Z_{opt}$
- UHS0 technology ($f_T = 25$ GHz) adopted
- High reliability through use of gold electrodes
- 3-pin lead-less minimold package (1005 PKG)

ORDERING INFORMATION

Part Number	Quantity	Supplying Form
NE894M13-A 2SC5787-A	50 pcs (Non reel)	• 8 mm wide embossed taping
NE894M13-T3-A 2SC5787-T3-A	10 kpcs/reel	• Pin 2 (Base) face the perforation side of the tape

Remark To order evaluation samples, please contact your nearby sales office.
Unit sample quantity is 50 pcs.

ABSOLUTE MAXIMUM RATINGS ($T_A = +25^\circ\text{C}$)

Parameter	Symbol	Ratings	Unit
Collector to Base Voltage	V_{CBO}	9.0	V
Collector to Emitter Voltage	V_{CEO}	3.0	V
Emitter to Base Voltage	V_{EBO}	1.5	V
Collector Current	I_C	35	mA
Total Power Dissipation	P_{tot} ^{Note}	105	mW
Junction Temperature	T_j	150	$^\circ\text{C}$
Storage Temperature	T_{stg}	-65 to +150	$^\circ\text{C}$

Note Mounted on $1.08\text{ cm}^2 \times 1.0\text{ mm}$ (t) glass epoxy PCB

Caution: Observe precautions when handling because these devices are sensitive to electrostatic discharge

The information in this document is subject to change without notice. Before using this document, please confirm that this is the latest version.

ELECTRICAL CHARACTERISTICS (T_A = +25°C)

Parameter	Symbol	Test Conditions	MIN.	TYP.	MAX.	Unit
DC Characteristics						
Collector Cut-off Current	I _{CBO}	V _{CB} = 5 V, I _E = 0 mA	–	–	100	nA
Emitter Cut-off Current	I _{EBO}	V _{EB} = 1 V, I _C = 0 mA	–	–	100	nA
DC Current Gain	h _{FE} ^{Note 1}	V _{CE} = 1 V, I _C = 5 mA	50	–	100	–
RF Characteristics						
Gain Bandwidth Product	f _T	V _{CE} = 1 V, I _C = 20 mA, f = 2 GHz	17	20	–	GHz
Insertion Power Gain	S _{21e} ²	V _{CE} = 1 V, I _C = 20 mA, f = 2 GHz	11	13	–	dB
Noise Figure	NF	V _{CE} = 1 V, I _C = 5 mA, f = 2 GHz, Z _S = Z _{opt}	–	1.4	2.5	dB
Reverse Transfer Capacitance	C _{re} ^{Note 2}	V _{CB} = 0.5 V, I _E = 0 mA, f = 1 MHz	–	0.22	0.30	pF

- Notes**
1. Pulse measurement: PW ≤ 350 μs, Duty Cycle ≤ 2%
 2. Collector to base capacitance when the emitter grounded

h_{FE} CLASSIFICATION

Rank	FB
Marking	B7
h _{FE} Value	50 to 100

TYPICAL CHARACTERISTICS (Unless otherwise specified, $T_A = +25^\circ\text{C}$)

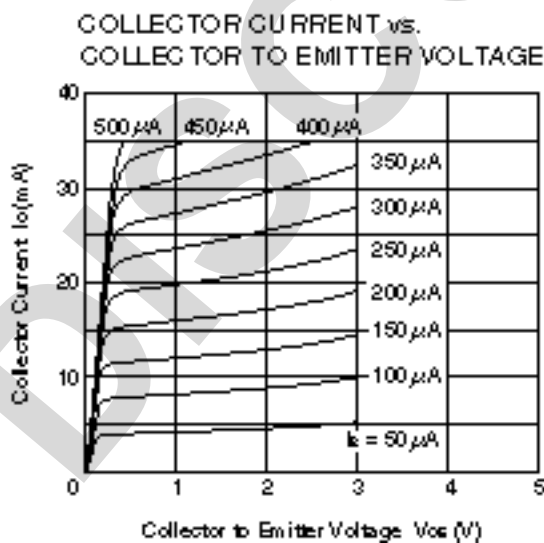
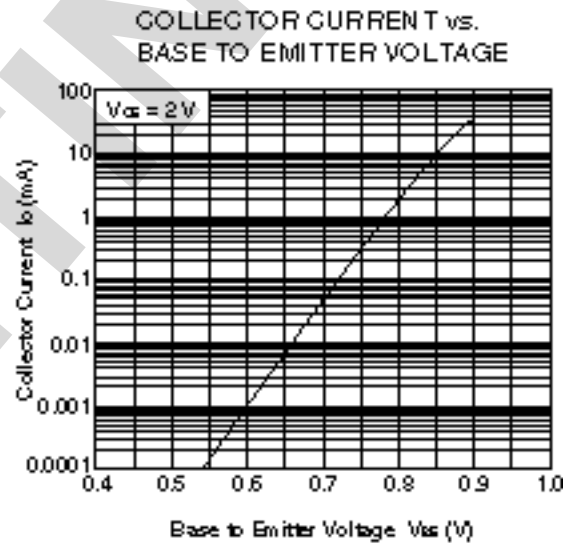
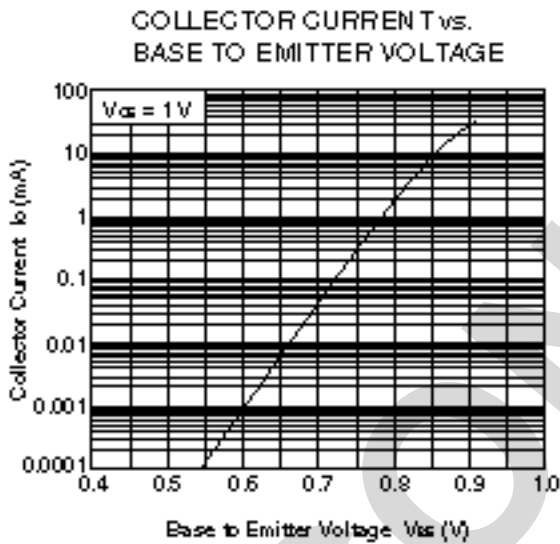
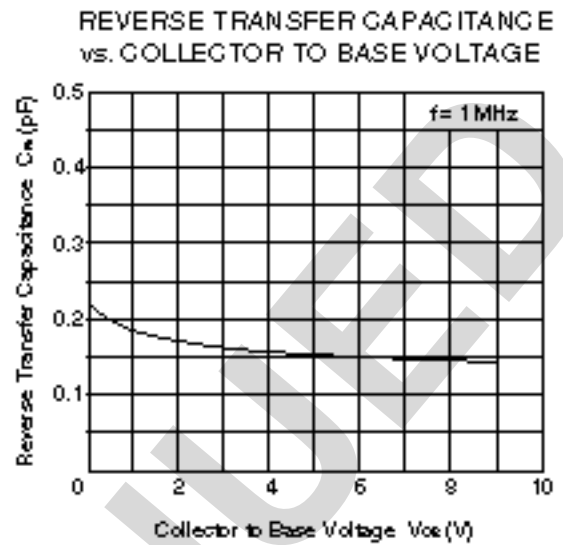
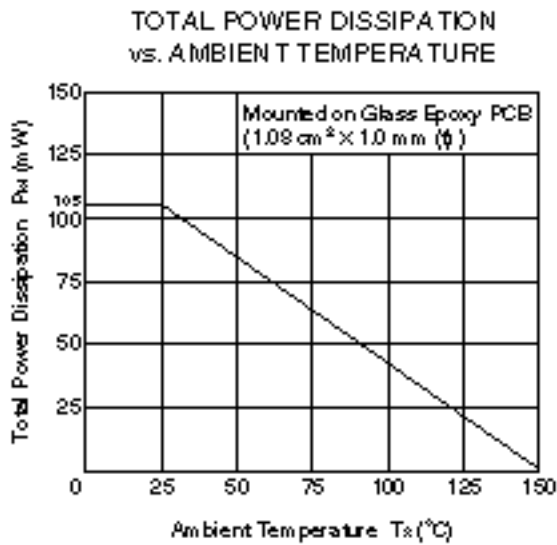

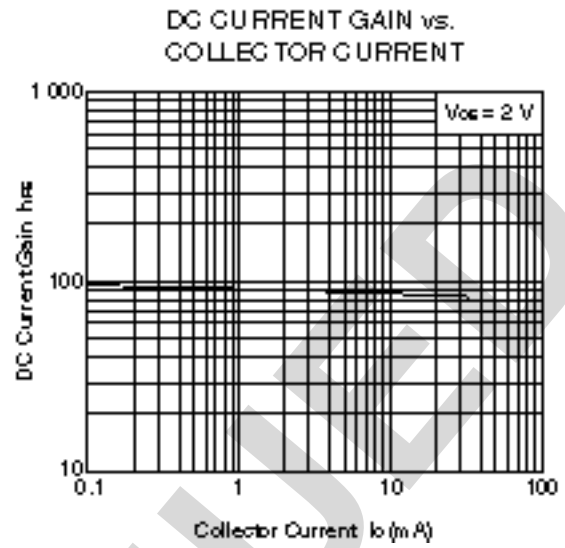
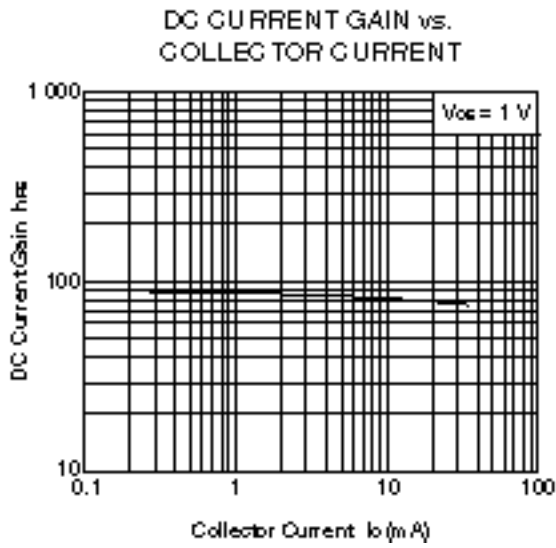

DISCONTINUED

GAIN BANDWIDTH PRODUCT vs. COLLECTOR CURRENT

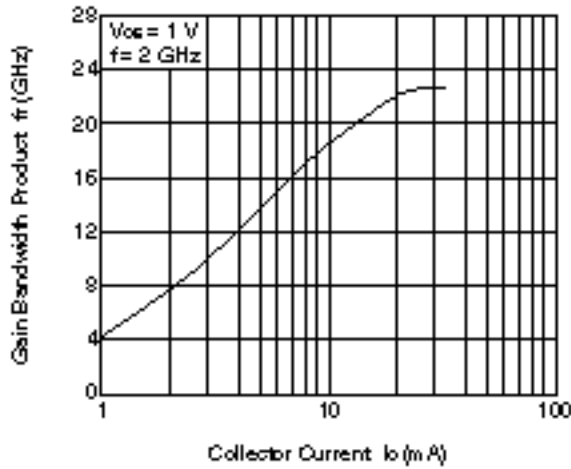

GAIN BANDWIDTH PRODUCT vs. COLLECTOR CURRENT

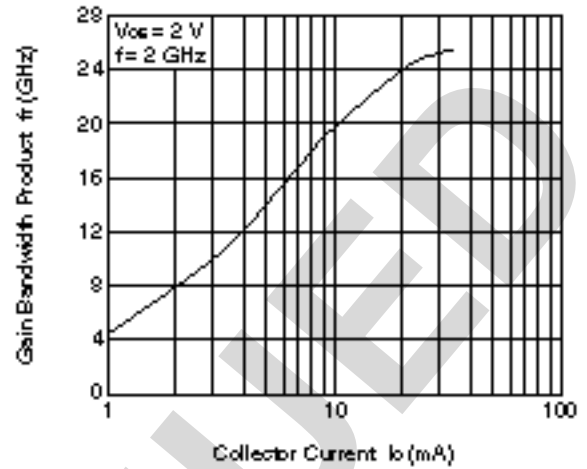

INSERTION POWER GAIN, MAG, MSG vs. FREQUENCY

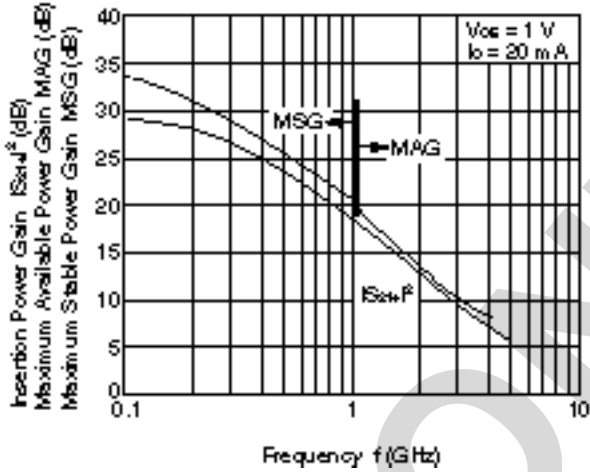

INSERTION POWER GAIN, MAG, MSG vs. FREQUENCY

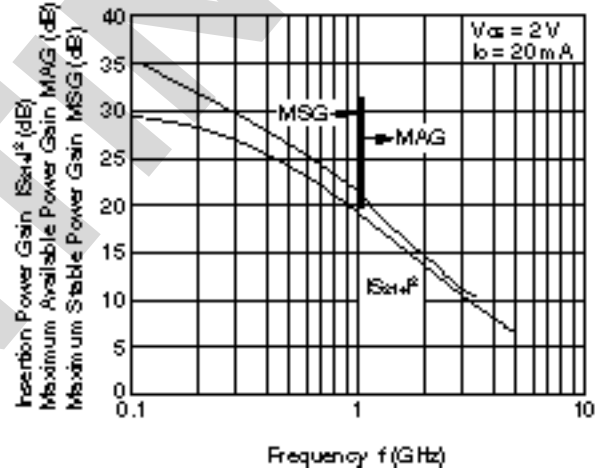

INSERTION POWER GAIN, MAG, MSG vs. COLLECTOR CURRENT

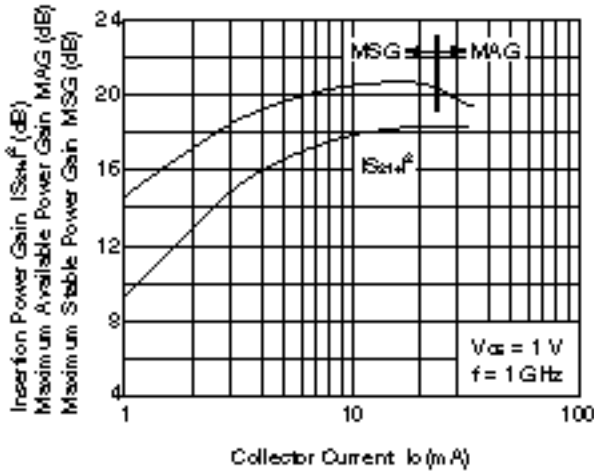

INSERTION POWER GAIN, MAG, MSG vs. COLLECTOR CURRENT

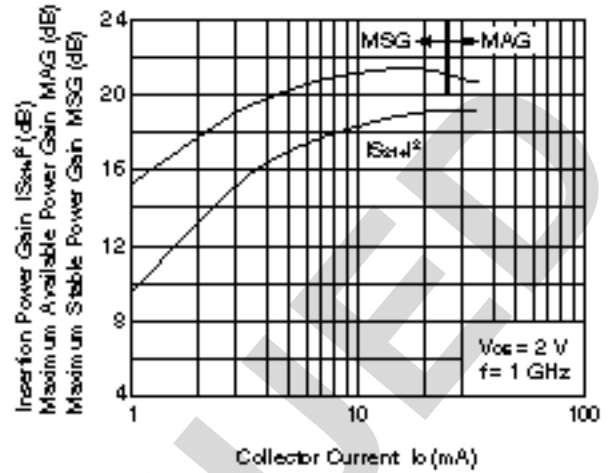

INSERTION POWER GAIN, MAG, MSG vs. COLLECTOR CURRENT

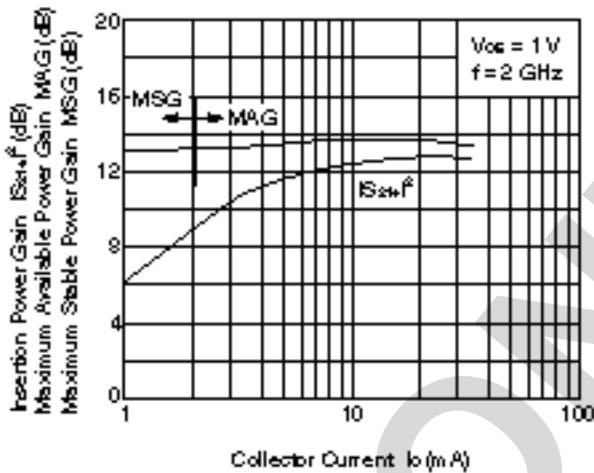

INSERTION POWER GAIN, MAG, MSG vs. COLLECTOR CURRENT

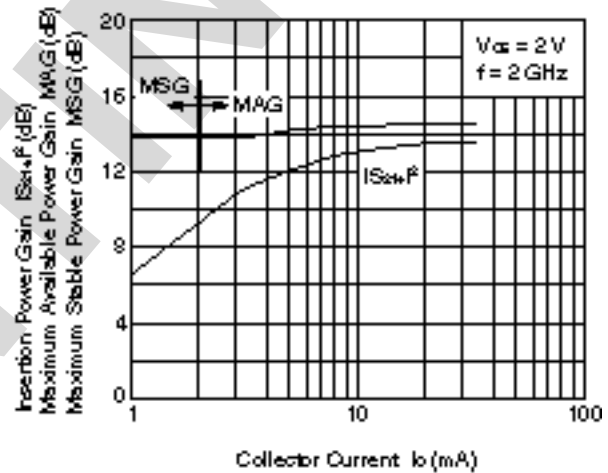

INSERTION POWER GAIN, MAG, MSG vs. COLLECTOR CURRENT

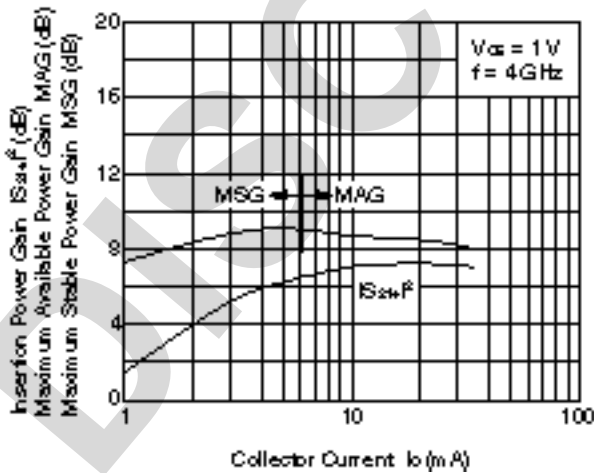

INSERTION POWER GAIN, MAG, MSG vs. COLLECTOR CURRENT

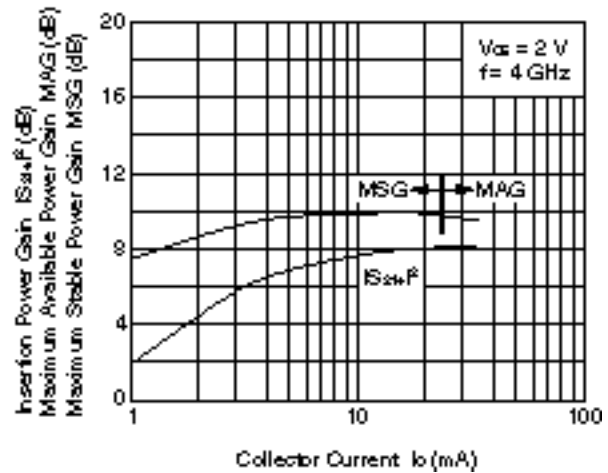

NOISE FIGURE, ASSOCIATED GAIN vs. COLLECTOR CURRENT

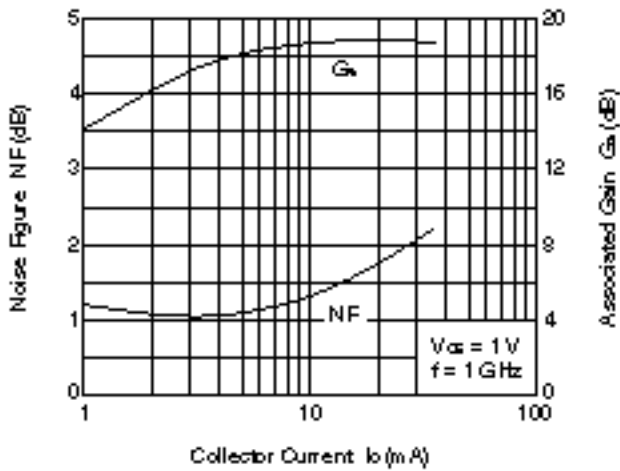

NOISE FIGURE, ASSOCIATED GAIN vs. COLLECTOR CURRENT

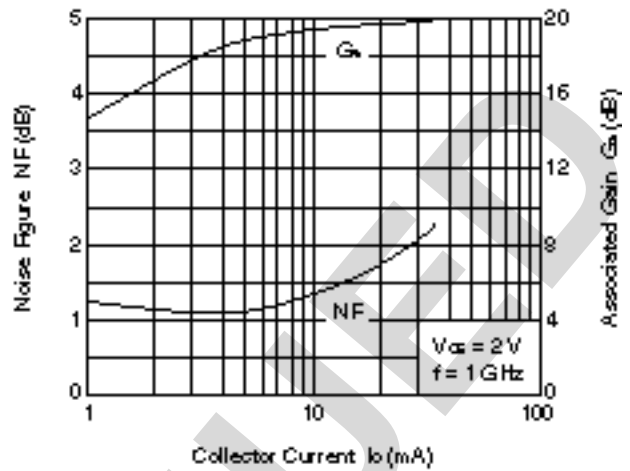

NOISE FIGURE, ASSOCIATED GAIN vs. COLLECTOR CURRENT

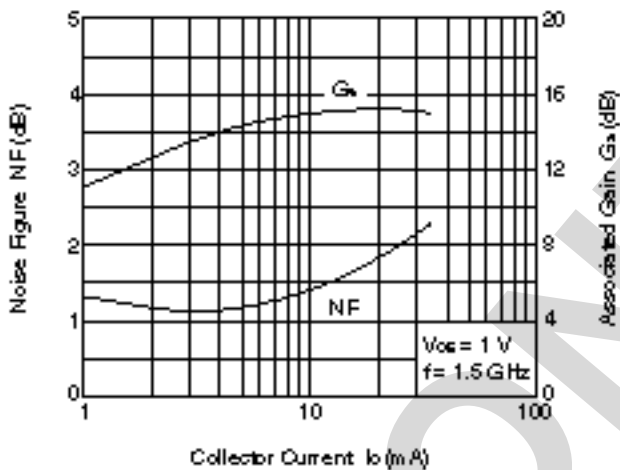

NOISE FIGURE, ASSOCIATED GAIN vs. COLLECTOR CURRENT

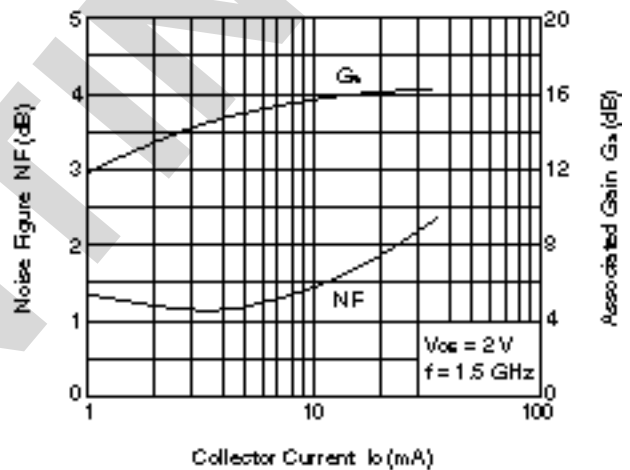

NOISE FIGURE, ASSOCIATED GAIN vs. COLLECTOR CURRENT

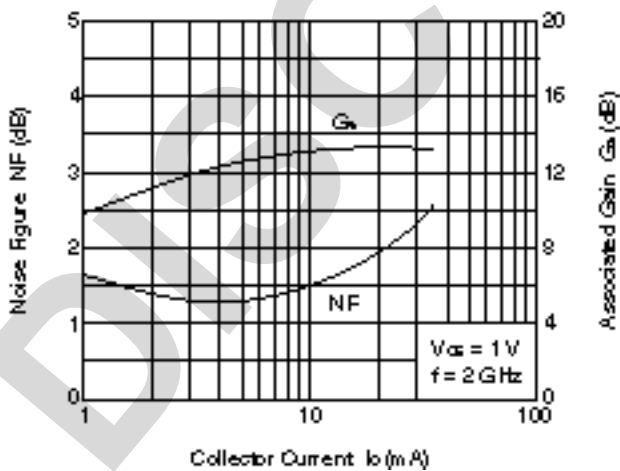

NOISE FIGURE, ASSOCIATED GAIN vs. COLLECTOR CURRENT

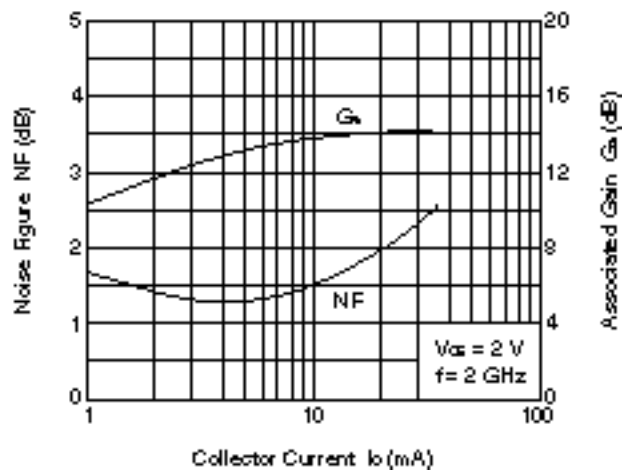

Remark The graphs indicate nominal characteristics.

S-PARAMETERS

V_{CE} = 1 V, I_c = 1 mA, Z₀ = 50 Ω

Frequency (GHz)	S ₁₁		S ₂₁		S ₁₂		S ₂₂	
	MAG.	ANG. (deg.)	MAG.	ANG. (deg.)	MAG.	ANG. (deg.)	MAG.	ANG. (deg.)
0.1	0.957	-5.9	3.498	176.3	0.014	90.4	0.995	-3.6
0.2	0.948	-13.1	3.497	167.7	0.027	81.4	0.985	-7.0
0.3	0.935	-20.0	3.456	162.0	0.040	76.6	0.977	-10.5
0.4	0.914	-26.4	3.391	156.1	0.052	72.3	0.960	-14.0
0.5	0.891	-33.1	3.334	149.9	0.063	67.8	0.942	-17.2
0.6	0.862	-39.3	3.273	144.7	0.073	63.9	0.921	-20.5
0.7	0.838	-45.9	3.199	139.3	0.082	59.9	0.899	-23.8
0.8	0.812	-52.3	3.116	133.9	0.090	56.6	0.875	-26.9
0.9	0.780	-58.5	3.013	128.6	0.096	53.2	0.851	-29.9
1.0	0.748	-64.6	2.919	123.6	0.101	50.3	0.827	-32.8
1.1	0.719	-70.7	2.820	118.9	0.105	47.4	0.802	-35.7
1.2	0.690	-76.8	2.729	114.3	0.108	45.1	0.779	-38.1
1.3	0.665	-82.9	2.636	109.8	0.109	43.0	0.758	-40.7
1.4	0.638	-88.3	2.544	105.6	0.110	41.2	0.740	-43.0
1.5	0.615	-94.1	2.451	101.4	0.110	39.6	0.723	-45.3
1.6	0.596	-99.6	2.363	97.5	0.109	38.6	0.707	-47.7
1.7	0.579	-105.1	2.277	94.1	0.107	38.1	0.690	-49.6
1.8	0.562	-110.3	2.213	90.6	0.105	38.0	0.678	-51.7
1.9	0.547	-115.4	2.121	87.5	0.103	38.5	0.668	-53.6
2.0	0.538	-120.4	2.056	84.2	0.100	39.4	0.658	-55.4
2.1	0.527	-124.9	1.974	81.5	0.098	40.7	0.648	-57.4
2.2	0.519	-129.8	1.918	78.3	0.096	42.6	0.639	-59.3
2.3	0.511	-134.0	1.856	75.5	0.094	45.2	0.630	-61.2
2.4	0.506	-138.5	1.800	72.6	0.093	48.2	0.626	-63.1
2.5	0.499	-142.7	1.743	69.8	0.092	51.7	0.618	-65.1
2.6	0.493	-146.9	1.689	67.4	0.093	55.8	0.614	-67.2
2.7	0.493	-151.1	1.636	64.8	0.095	59.6	0.607	-69.1
2.8	0.488	-155.0	1.589	62.5	0.098	63.9	0.604	-71.0
2.9	0.484	-159.3	1.541	60.3	0.102	67.7	0.597	-73.4
3.0	0.486	-162.9	1.498	57.6	0.108	71.6	0.595	-75.6
4.0	0.516	162.3	1.187	37.5	0.220	83.5	0.577	-99.6
5.0	0.600	139.0	0.972	22.2	0.355	71.1	0.569	-132.8

$V_{CE} = 1\text{ V}$, $I_C = 3\text{ mA}$, $Z_O = 50\ \Omega$

Frequency (GHz)	S ₁₁		S ₂₁		S ₁₂		S ₂₂	
	MAG.	ANG. (deg.)	MAG.	ANG. (deg.)	MAG.	ANG. (deg.)	MAG.	ANG. (deg.)
0.1	0.874	-9.0	9.218	171.6	0.014	84.1	0.979	-6.0
0.2	0.852	-19.1	9.002	161.7	0.025	78.4	0.954	-11.6
0.3	0.813	-28.7	8.618	153.1	0.037	72.9	0.921	-17.0
0.4	0.766	-37.4	8.211	145.2	0.047	68.7	0.877	-21.7
0.5	0.717	-45.7	7.730	137.7	0.055	64.7	0.832	-26.0
0.6	0.663	-53.1	7.285	131.4	0.063	61.6	0.786	-29.7
0.7	0.617	-60.5	6.836	125.3	0.068	59.1	0.742	-33.1
0.8	0.573	-67.1	6.399	119.8	0.073	57.1	0.700	-35.8
0.9	0.529	-73.8	5.984	114.8	0.077	55.6	0.664	-38.4
1.0	0.491	-79.8	5.604	110.1	0.081	54.7	0.630	-40.7
1.1	0.461	-85.7	5.239	106.1	0.083	54.1	0.599	-43.3
1.2	0.428	-91.9	4.961	102.4	0.086	54.1	0.571	-44.7
1.3	0.403	-97.4	4.675	98.6	0.089	54.2	0.549	-46.4
1.4	0.380	-102.9	4.417	95.1	0.092	54.5	0.530	-48.1
1.5	0.361	-108.0	4.196	91.8	0.094	54.9	0.513	-49.7
1.6	0.342	-113.7	3.986	88.9	0.096	55.7	0.498	-51.2
1.7	0.332	-119.3	3.792	86.2	0.099	56.5	0.485	-52.7
1.8	0.320	-124.2	3.628	83.6	0.102	57.5	0.473	-54.1
1.9	0.313	-128.9	3.456	81.0	0.104	58.6	0.465	-55.4
2.0	0.305	-133.6	3.318	78.7	0.107	59.6	0.455	-56.7
2.1	0.300	-137.4	3.166	76.5	0.111	60.7	0.448	-58.1
2.2	0.298	-142.0	3.058	74.1	0.114	61.9	0.440	-59.7
2.3	0.293	-145.8	2.936	71.8	0.118	62.9	0.435	-61.1
2.4	0.290	-150.0	2.833	69.7	0.123	63.9	0.429	-62.5
2.5	0.289	-154.2	2.737	67.5	0.127	65.0	0.424	-63.9
2.6	0.288	-157.5	2.647	65.8	0.131	66.0	0.420	-65.4
2.7	0.288	-161.3	2.554	63.8	0.137	66.9	0.416	-66.9
2.8	0.288	-164.6	2.478	61.8	0.142	67.9	0.412	-68.5
2.9	0.286	-168.3	2.401	60.0	0.148	68.4	0.407	-70.5
3.0	0.291	-171.0	2.326	57.9	0.154	69.2	0.407	-72.1
4.0	0.350	160.1	1.831	40.4	0.238	71.0	0.390	-94.4
5.0	0.466	142.5	1.531	24.1	0.332	63.4	0.377	-125.3

$V_{CE} = 1\text{ V}$, $I_C = 5\text{ mA}$, $Z_O = 50\ \Omega$

Frequency (GHz)	S ₁₁		S ₂₁		S ₁₂		S ₂₂	
	MAG.	ANG. (deg.)	MAG.	ANG. (deg.)	MAG.	ANG. (deg.)	MAG.	ANG. (deg.)
0.1	0.814	-12.0	13.715	168.7	0.013	84.4	0.963	-8.0
0.2	0.769	-23.5	13.118	156.8	0.024	77.9	0.921	-15.1
0.3	0.710	-34.5	12.219	146.6	0.034	71.6	0.866	-21.5
0.4	0.653	-44.1	11.267	137.8	0.042	67.4	0.804	-26.7
0.5	0.589	-53.0	10.291	129.9	0.050	64.7	0.744	-30.9
0.6	0.529	-60.4	9.433	123.5	0.056	62.7	0.689	-34.2
0.7	0.478	-67.6	8.649	117.6	0.061	61.3	0.638	-37.1
0.8	0.436	-74.1	7.940	112.6	0.066	60.7	0.596	-39.4
0.9	0.397	-80.6	7.292	108.0	0.070	60.2	0.559	-41.4
1.0	0.361	-86.2	6.740	103.8	0.074	60.2	0.529	-43.1
1.1	0.334	-92.3	6.236	100.4	0.078	60.4	0.499	-45.3
1.2	0.307	-98.5	5.852	97.0	0.082	61.0	0.474	-46.2
1.3	0.289	-104.7	5.474	93.7	0.086	61.5	0.454	-47.6
1.4	0.269	-109.7	5.135	90.7	0.090	61.9	0.438	-49.0
1.5	0.256	-115.5	4.852	87.9	0.094	62.5	0.424	-50.2
1.6	0.241	-120.9	4.589	85.4	0.098	63.3	0.412	-51.5
1.7	0.236	-126.5	4.343	83.0	0.102	63.7	0.402	-52.8
1.8	0.228	-131.7	4.144	80.7	0.107	64.4	0.392	-54.0
1.9	0.224	-136.0	3.952	78.7	0.111	65.0	0.384	-55.1
2.0	0.221	-141.7	3.779	76.7	0.116	65.6	0.377	-56.4
2.1	0.217	-144.7	3.599	74.9	0.121	66.0	0.370	-57.6
2.2	0.218	-149.5	3.468	72.6	0.125	66.4	0.364	-59.0
2.3	0.214	-153.2	3.327	70.8	0.131	66.9	0.359	-60.2
2.4	0.215	-157.0	3.211	68.7	0.136	67.1	0.354	-61.7
2.5	0.215	-160.9	3.093	66.9	0.141	67.5	0.350	-63.0
2.6	0.215	-164.5	2.990	65.2	0.147	67.7	0.346	-64.6
2.7	0.218	-167.4	2.885	63.4	0.153	67.9	0.342	-65.9
2.8	0.220	-170.8	2.795	61.8	0.159	68.2	0.339	-67.5
2.9	0.220	-175.3	2.704	60.1	0.165	68.1	0.336	-69.5
3.0	0.224	-177.3	2.623	58.2	0.172	68.3	0.335	-70.9
4.0	0.293	157.4	2.054	42.1	0.249	67.0	0.315	-93.8
5.0	0.411	142.4	1.731	26.8	0.330	59.6	0.296	-125.0

$V_{CE} = 1\text{ V}$, $I_c = 7\text{ mA}$, $Z_O = 50\ \Omega$

Frequency (GHz)	S ₁₁		S ₂₁		S ₁₂		S ₂₂	
	MAG.	ANG. (deg.)	MAG.	ANG. (deg.)	MAG.	ANG. (deg.)	MAG.	ANG. (deg.)
0.1	0.751	-13.8	17.289	166.4	0.013	88.0	0.948	-9.5
0.2	0.704	-27.1	16.208	153.1	0.023	77.2	0.891	-17.8
0.3	0.635	-39.0	14.738	142.0	0.032	71.2	0.822	-24.6
0.4	0.562	-48.8	13.254	132.7	0.040	67.9	0.747	-29.8
0.5	0.497	-57.4	11.850	124.6	0.046	65.7	0.680	-33.7
0.6	0.439	-65.2	10.665	118.4	0.053	64.4	0.622	-36.8
0.7	0.393	-72.2	9.647	113.0	0.058	63.9	0.572	-39.0
0.8	0.352	-78.3	8.746	108.2	0.062	63.7	0.531	-40.8
0.9	0.315	-84.4	7.994	104.1	0.067	63.9	0.497	-42.4
1.0	0.284	-90.3	7.331	100.2	0.072	64.1	0.469	-43.9
1.1	0.266	-96.4	6.746	97.2	0.076	64.7	0.441	-45.8
1.2	0.241	-103.3	6.296	94.2	0.081	65.2	0.419	-46.6
1.3	0.223	-109.0	5.873	91.3	0.086	65.7	0.403	-47.7
1.4	0.210	-114.6	5.512	88.6	0.091	66.0	0.389	-48.9
1.5	0.196	-120.6	5.179	86.0	0.096	66.3	0.376	-50.1
1.6	0.189	-126.2	4.892	83.7	0.101	66.8	0.366	-51.4
1.7	0.186	-131.9	4.640	81.6	0.106	67.2	0.356	-52.5
1.8	0.180	-137.9	4.407	79.4	0.111	67.5	0.348	-53.7
1.9	0.177	-142.4	4.196	77.4	0.116	67.7	0.340	-54.8
2.0	0.179	-147.0	4.013	75.5	0.121	68.0	0.334	-56.0
2.1	0.177	-150.9	3.821	73.8	0.127	68.1	0.328	-57.2
2.2	0.180	-155.4	3.673	71.8	0.132	68.1	0.323	-58.7
2.3	0.178	-159.2	3.524	70.1	0.138	68.3	0.319	-59.9
2.4	0.178	-163.4	3.400	68.1	0.144	68.3	0.315	-61.3
2.5	0.180	-166.6	3.269	66.4	0.150	68.3	0.310	-62.6
2.6	0.182	-170.5	3.161	64.9	0.155	68.3	0.306	-64.0
2.7	0.185	-173.6	3.050	63.2	0.162	68.1	0.303	-65.4
2.8	0.186	-176.9	2.962	61.5	0.168	68.1	0.299	-67.0
2.9	0.189	178.7	2.857	60.1	0.174	67.9	0.297	-69.0
3.0	0.194	177.4	2.772	58.3	0.181	67.8	0.296	-70.3
4.0	0.265	154.5	2.164	43.1	0.256	65.1	0.275	-94.2
5.0	0.382	142.2	1.825	28.7	0.331	57.3	0.250	-127.2

$V_{CE} = 1\text{ V}$, $I_C = 10\text{ mA}$, $Z_o = 50\ \Omega$

Frequency (GHz)	S ₁₁		S ₂₁		S ₁₂		S ₂₂	
	MAG.	ANG. (deg.)	MAG.	ANG. (deg.)	MAG.	ANG. (deg.)	MAG.	ANG. (deg.)
0.1	0.675	-16.2	21.450	163.8	0.012	89.2	0.927	-11.4
0.2	0.615	-30.4	19.591	149.0	0.022	75.8	0.852	-20.7
0.3	0.539	-43.5	17.269	136.9	0.031	70.5	0.767	-27.9
0.4	0.468	-53.4	15.113	127.6	0.037	68.3	0.683	-32.8
0.5	0.404	-61.8	13.234	119.7	0.044	67.5	0.612	-36.1
0.6	0.351	-69.4	11.718	113.9	0.050	67.1	0.555	-38.7
0.7	0.310	-76.2	10.489	108.7	0.055	67.0	0.509	-40.6
0.8	0.274	-82.3	9.426	104.4	0.060	67.2	0.471	-41.9
0.9	0.241	-88.1	8.533	100.4	0.066	67.6	0.440	-43.2
1.0	0.217	-94.3	7.802	97.1	0.071	68.0	0.415	-44.4
1.1	0.204	-101.0	7.152	94.5	0.076	68.4	0.390	-46.2
1.2	0.185	-107.9	6.658	91.7	0.082	68.9	0.371	-46.4
1.3	0.170	-114.5	6.203	89.1	0.087	69.2	0.356	-47.5
1.4	0.162	-119.9	5.795	86.6	0.093	69.3	0.344	-48.6
1.5	0.151	-126.9	5.450	84.2	0.098	69.4	0.333	-49.7
1.6	0.145	-133.8	5.139	82.2	0.104	69.5	0.324	-51.0
1.7	0.146	-139.0	4.859	80.2	0.109	69.6	0.316	-52.2
1.8	0.143	-145.4	4.622	78.3	0.115	69.7	0.308	-53.3
1.9	0.143	-150.0	4.393	76.3	0.121	69.7	0.302	-54.6
2.0	0.147	-155.5	4.195	74.5	0.127	69.7	0.297	-55.8
2.1	0.144	-157.3	3.987	73.0	0.133	69.6	0.291	-57.0
2.2	0.148	-163.1	3.838	71.1	0.139	69.3	0.286	-58.5
2.3	0.148	-166.9	3.679	69.4	0.145	69.2	0.283	-59.6
2.4	0.150	-170.6	3.548	67.7	0.151	69.0	0.279	-61.2
2.5	0.153	-174.2	3.410	66.0	0.157	68.8	0.275	-62.4
2.6	0.156	-177.9	3.303	64.5	0.163	68.5	0.271	-64.0
2.7	0.159	179.7	3.180	63.0	0.170	68.2	0.268	-65.4
2.8	0.162	177.0	3.084	61.4	0.176	68.0	0.265	-67.1
2.9	0.166	172.5	2.982	60.1	0.182	67.5	0.263	-69.2
3.0	0.171	171.2	2.887	58.4	0.189	67.3	0.261	-70.4
4.0	0.246	151.5	2.243	44.0	0.263	63.4	0.240	-95.8
5.0	0.361	140.7	1.899	30.0	0.333	55.4	0.214	-131.0

$V_{CE} = 1\text{ V}$, $I_C = 20\text{ mA}$, $Z_0 = 50\ \Omega$

Frequency (GHz)	S ₁₁		S ₂₁		S ₁₂		S ₂₂	
	MAG.	ANG. (deg.)	MAG.	ANG. (deg.)	MAG.	ANG. (deg.)	MAG.	ANG. (deg.)
0.1	0.525	-20.5	29.163	158.8	0.013	82.1	0.871	-14.8
0.2	0.446	-36.9	25.100	141.2	0.020	75.4	0.763	-25.9
0.3	0.368	-52.1	20.892	128.5	0.028	73.2	0.655	-32.9
0.4	0.306	-61.5	17.541	119.5	0.034	71.9	0.567	-37.0
0.5	0.254	-69.7	14.890	112.3	0.041	72.0	0.500	-39.2
0.6	0.215	-77.6	12.939	107.2	0.047	72.4	0.448	-40.9
0.7	0.185	-84.0	11.382	102.6	0.053	72.4	0.409	-41.9
0.8	0.164	-91.2	10.138	99.1	0.059	72.7	0.378	-42.7
0.9	0.142	-97.8	9.107	95.8	0.066	73.1	0.354	-43.6
1.0	0.128	-105.6	8.276	92.8	0.072	73.0	0.335	-44.6
1.1	0.124	-114.5	7.561	90.5	0.078	73.2	0.314	-46.4
1.2	0.112	-124.6	7.020	88.3	0.085	73.3	0.298	-46.7
1.3	0.106	-132.3	6.511	86.0	0.091	73.2	0.287	-47.7
1.4	0.103	-140.9	6.081	83.8	0.097	72.9	0.277	-48.9
1.5	0.101	-147.5	5.711	81.7	0.104	72.8	0.268	-50.0
1.6	0.102	-155.6	5.354	79.9	0.110	72.5	0.262	-51.4
1.7	0.105	-160.6	5.070	78.0	0.117	72.1	0.255	-52.7
1.8	0.107	-166.4	4.816	76.4	0.123	72.0	0.249	-54.1
1.9	0.110	-170.6	4.578	74.8	0.129	71.7	0.244	-55.2
2.0	0.117	-174.3	4.369	73.1	0.136	71.3	0.239	-56.5
2.1	0.117	-177.1	4.158	71.8	0.143	70.9	0.235	-57.9
2.2	0.124	179.3	3.988	70.1	0.149	70.3	0.230	-59.5
2.3	0.123	174.7	3.822	68.5	0.156	70.0	0.227	-60.9
2.4	0.130	172.9	3.683	66.9	0.162	69.4	0.223	-62.5
2.5	0.133	169.7	3.543	65.4	0.168	69.1	0.220	-64.0
2.6	0.139	167.2	3.423	64.1	0.175	68.6	0.217	-65.7
2.7	0.142	165.9	3.300	62.7	0.182	67.9	0.214	-67.3
2.8	0.145	163.2	3.200	61.1	0.189	67.5	0.211	-69.3
2.9	0.149	160.0	3.089	59.9	0.195	66.8	0.209	-71.6
3.0	0.154	159.1	2.988	58.4	0.202	66.3	0.208	-72.9
4.0	0.233	145.5	2.312	44.7	0.275	61.0	0.190	-102.3
5.0	0.344	137.2	1.948	31.6	0.340	52.4	0.169	-144.0

$V_{CE} = 2\text{ V}$, $I_C = 1\text{ mA}$, $Z_O = 50\ \Omega$

Frequency (GHz)	S ₁₁		S ₂₁		S ₁₂		S ₂₂	
	MAG.	ANG. (deg.)	MAG.	ANG. (deg.)	MAG.	ANG. (deg.)	MAG.	ANG. (deg.)
0.1	0.967	-5.7	3.494	176.4	0.012	92.9	0.995	-3.2
0.2	0.950	-12.5	3.491	168.4	0.024	81.8	0.987	-6.4
0.3	0.937	-18.8	3.459	162.8	0.035	77.1	0.979	-9.6
0.4	0.919	-25.0	3.409	157.1	0.045	73.2	0.964	-12.7
0.5	0.896	-31.3	3.345	151.0	0.055	69.1	0.948	-15.7
0.6	0.869	-37.5	3.289	146.0	0.064	65.3	0.930	-18.8
0.7	0.846	-43.6	3.223	140.8	0.072	61.5	0.908	-21.7
0.8	0.820	-49.6	3.145	135.6	0.079	58.2	0.888	-24.6
0.9	0.790	-55.7	3.050	130.5	0.084	55.1	0.864	-27.4
1.0	0.759	-61.7	2.961	125.6	0.089	52.3	0.844	-30.1
1.1	0.729	-67.5	2.874	121.0	0.092	49.7	0.822	-32.7
1.2	0.701	-73.2	2.778	116.4	0.095	47.4	0.802	-35.2
1.3	0.674	-79.0	2.696	112.0	0.096	45.5	0.780	-37.7
1.4	0.649	-84.6	2.600	107.9	0.096	43.7	0.764	-39.9
1.5	0.625	-90.0	2.514	103.7	0.096	42.5	0.747	-42.1
1.6	0.603	-95.6	2.427	99.9	0.095	41.8	0.732	-44.3
1.7	0.585	-101.1	2.340	96.4	0.093	41.4	0.718	-46.4
1.8	0.567	-106.3	2.277	92.9	0.092	41.7	0.705	-48.3
1.9	0.554	-111.2	2.191	89.5	0.089	42.6	0.694	-50.1
2.0	0.540	-116.3	2.117	86.4	0.087	43.9	0.685	-51.9
2.1	0.529	-120.6	2.038	83.6	0.085	45.9	0.676	-53.7
2.2	0.520	-125.5	1.982	80.4	0.083	48.5	0.667	-55.7
2.3	0.511	-129.6	1.916	77.7	0.082	52.1	0.660	-57.4
2.4	0.502	-134.4	1.863	74.7	0.082	55.6	0.655	-59.3
2.5	0.496	-138.6	1.808	72.0	0.082	59.9	0.648	-61.1
2.6	0.491	-143.0	1.751	69.5	0.083	64.4	0.644	-63.0
2.7	0.485	-147.0	1.693	66.9	0.086	68.9	0.637	-64.9
2.8	0.482	-151.0	1.649	64.6	0.091	73.3	0.633	-66.8
2.9	0.477	-155.0	1.603	62.2	0.096	77.1	0.626	-69.0
3.0	0.477	-159.0	1.552	59.7	0.103	80.8	0.625	-71.1
4.0	0.502	165.1	1.241	39.5	0.223	89.2	0.608	-94.2
5.0	0.586	140.9	1.018	23.6	0.363	75.3	0.596	-126.4

$V_{CE} = 2\text{ V}$, $I_C = 3\text{ mA}$, $Z_O = 50\ \Omega$

Frequency (GHz)	S ₁₁		S ₂₁		S ₁₂		S ₂₂	
	MAG.	ANG. (deg.)	MAG.	ANG. (deg.)	MAG.	ANG. (deg.)	MAG.	ANG. (deg.)
0.1	0.888	-8.2	9.232	172.0	0.011	91.6	0.982	-5.4
0.2	0.860	-18.1	9.035	162.5	0.022	78.5	0.960	-10.3
0.3	0.822	-26.4	8.690	154.4	0.032	73.8	0.932	-15.2
0.4	0.781	-34.5	8.306	146.8	0.041	70.3	0.891	-19.4
0.5	0.732	-42.1	7.861	139.3	0.048	66.3	0.851	-23.2
0.6	0.681	-49.0	7.412	133.2	0.055	63.4	0.809	-26.6
0.7	0.639	-55.9	6.991	127.3	0.060	60.8	0.767	-29.7
0.8	0.590	-62.1	6.577	121.9	0.065	59.2	0.731	-32.2
0.9	0.548	-68.1	6.166	116.9	0.069	57.8	0.695	-34.6
1.0	0.507	-73.7	5.808	112.3	0.072	57.1	0.664	-36.7
1.1	0.471	-79.4	5.465	108.2	0.075	56.7	0.635	-38.5
1.2	0.439	-84.3	5.160	104.5	0.077	56.6	0.611	-40.2
1.3	0.412	-89.8	4.875	100.9	0.079	56.9	0.586	-41.9
1.4	0.388	-94.9	4.604	97.4	0.082	57.2	0.569	-43.4
1.5	0.364	-99.9	4.377	94.1	0.084	58.0	0.553	-44.9
1.6	0.345	-105.3	4.167	91.2	0.086	58.9	0.538	-46.3
1.7	0.332	-110.0	3.967	88.4	0.089	59.8	0.525	-47.7
1.8	0.319	-115.1	3.802	85.8	0.091	61.2	0.513	-48.9
1.9	0.307	-119.6	3.628	83.0	0.094	62.4	0.505	-50.1
2.0	0.300	-124.4	3.481	80.7	0.097	63.6	0.496	-51.4
2.1	0.293	-127.9	3.327	78.6	0.100	65.0	0.490	-52.6
2.2	0.285	-132.3	3.210	76.2	0.103	66.2	0.483	-54.1
2.3	0.280	-136.4	3.083	73.9	0.108	67.6	0.477	-55.3
2.4	0.275	-141.1	2.982	71.6	0.112	68.6	0.472	-56.7
2.5	0.270	-144.7	2.878	69.6	0.116	69.9	0.467	-58.0
2.6	0.271	-148.3	2.782	68.0	0.121	71.0	0.464	-59.5
2.7	0.269	-152.0	2.688	65.8	0.126	72.0	0.460	-60.9
2.8	0.268	-155.6	2.609	64.0	0.132	73.0	0.456	-62.4
2.9	0.266	-159.8	2.522	62.2	0.138	73.7	0.452	-64.2
3.0	0.267	-162.2	2.450	60.1	0.144	74.6	0.451	-65.7
4.0	0.320	166.3	1.944	42.6	0.230	76.5	0.434	-86.2
5.0	0.435	147.4	1.638	26.2	0.330	68.4	0.418	-115.1

$V_{CE} = 2\text{ V}$, $I_C = 5\text{ mA}$, $Z_O = 50\ \Omega$

Frequency (GHz)	S ₁₁		S ₂₁		S ₁₂		S ₂₂	
	MAG.	ANG. (deg.)	MAG.	ANG. (deg.)	MAG.	ANG. (deg.)	MAG.	ANG. (deg.)
0.1	0.834	-10.8	13.678	169.2	0.011	81.4	0.968	-6.9
0.2	0.782	-21.0	13.160	158.0	0.021	79.7	0.932	-13.3
0.3	0.734	-31.4	12.347	148.2	0.030	73.4	0.883	-18.8
0.4	0.674	-39.8	11.437	139.7	0.038	69.3	0.828	-23.5
0.5	0.615	-48.2	10.513	131.8	0.044	66.5	0.774	-27.2
0.6	0.554	-54.7	9.700	125.6	0.050	64.5	0.723	-30.2
0.7	0.501	-61.2	8.946	119.8	0.055	63.2	0.675	-32.7
0.8	0.459	-67.2	8.225	114.8	0.059	62.7	0.635	-34.8
0.9	0.414	-72.5	7.581	110.2	0.063	62.4	0.600	-36.6
1.0	0.379	-77.7	7.042	106.0	0.067	62.6	0.569	-38.1
1.1	0.345	-83.0	6.563	102.4	0.070	62.8	0.544	-39.4
1.2	0.319	-88.0	6.130	99.1	0.074	63.2	0.520	-40.9
1.3	0.295	-93.0	5.745	95.9	0.077	63.9	0.500	-42.1
1.4	0.275	-97.5	5.408	93.0	0.081	64.5	0.485	-43.3
1.5	0.256	-102.5	5.108	90.1	0.085	65.2	0.472	-44.5
1.6	0.240	-107.7	4.828	87.6	0.089	65.9	0.460	-45.6
1.7	0.232	-112.5	4.580	85.2	0.093	66.6	0.449	-46.9
1.8	0.220	-117.6	4.373	83.0	0.097	67.4	0.440	-47.8
1.9	0.213	-122.1	4.171	80.7	0.101	68.2	0.432	-48.8
2.0	0.209	-127.5	3.988	78.7	0.105	68.9	0.425	-49.9
2.1	0.202	-130.5	3.805	76.9	0.110	69.5	0.419	-51.0
2.2	0.199	-135.6	3.663	74.7	0.114	70.0	0.413	-52.3
2.3	0.195	-139.4	3.522	72.8	0.120	70.6	0.409	-53.5
2.4	0.193	-143.5	3.395	70.7	0.125	70.9	0.404	-54.7
2.5	0.193	-147.6	3.269	69.0	0.130	71.3	0.400	-55.9
2.6	0.191	-151.1	3.164	67.3	0.135	71.8	0.396	-57.1
2.7	0.192	-155.3	3.050	65.6	0.141	72.2	0.394	-58.4
2.8	0.191	-158.1	2.963	63.9	0.147	72.5	0.389	-59.8
2.9	0.191	-162.8	2.867	62.4	0.153	72.7	0.386	-61.5
3.0	0.192	-165.8	2.777	60.4	0.159	72.9	0.385	-62.9
4.0	0.254	165.2	2.191	44.6	0.238	72.2	0.365	-83.4
5.0	0.373	148.8	1.861	29.2	0.323	64.6	0.338	-111.7

$V_{CE} = 2\text{ V}$, $I_C = 7\text{ mA}$, $Z_O = 50\ \Omega$

Frequency (GHz)	S ₁₁		S ₂₁		S ₁₂		S ₂₂	
	MAG.	ANG. (deg.)	MAG.	ANG. (deg.)	MAG.	ANG. (deg.)	MAG.	ANG. (deg.)
0.1	0.773	-12.2	17.302	167.1	0.012	86.2	0.956	-8.3
0.2	0.720	-24.0	16.283	154.5	0.021	77.1	0.907	-15.4
0.3	0.657	-34.7	14.949	143.8	0.029	72.1	0.846	-21.4
0.4	0.591	-43.6	13.554	134.8	0.035	69.8	0.778	-26.1
0.5	0.525	-51.1	12.204	126.9	0.041	67.5	0.717	-29.5
0.6	0.466	-57.7	11.059	120.8	0.047	66.2	0.662	-32.2
0.7	0.417	-63.8	10.035	115.1	0.051	65.7	0.614	-34.3
0.8	0.375	-69.2	9.130	110.4	0.056	65.7	0.576	-35.9
0.9	0.337	-74.5	8.366	106.2	0.060	66.0	0.542	-37.3
1.0	0.302	-79.0	7.705	102.5	0.065	66.4	0.514	-38.4
1.1	0.275	-83.8	7.144	99.1	0.069	66.8	0.490	-39.6
1.2	0.250	-88.9	6.639	96.0	0.073	67.5	0.470	-40.7
1.3	0.230	-93.4	6.197	93.2	0.078	67.9	0.452	-41.6
1.4	0.214	-98.2	5.832	90.5	0.082	68.3	0.439	-42.6
1.5	0.197	-102.8	5.477	87.9	0.087	68.9	0.426	-43.6
1.6	0.186	-108.3	5.174	85.7	0.091	69.4	0.417	-44.7
1.7	0.175	-112.9	4.904	83.5	0.096	69.7	0.408	-45.8
1.8	0.167	-119.0	4.670	81.4	0.101	70.3	0.400	-46.8
1.9	0.162	-123.7	4.453	79.4	0.106	70.8	0.393	-47.8
2.0	0.161	-129.3	4.257	77.5	0.110	71.0	0.387	-48.8
2.1	0.157	-132.1	4.058	75.8	0.116	71.2	0.382	-49.8
2.2	0.154	-137.3	3.905	73.8	0.121	71.4	0.376	-51.1
2.3	0.151	-141.5	3.746	72.0	0.127	71.7	0.372	-52.2
2.4	0.150	-146.0	3.609	70.2	0.132	71.7	0.368	-53.5
2.5	0.148	-149.6	3.479	68.5	0.137	71.8	0.364	-54.6
2.6	0.148	-154.1	3.363	67.0	0.143	71.9	0.360	-55.8
2.7	0.150	-157.5	3.244	65.4	0.149	72.0	0.357	-57.0
2.8	0.151	-161.4	3.147	63.7	0.155	72.1	0.354	-58.4
2.9	0.151	-165.8	3.043	62.3	0.161	71.9	0.351	-60.2
3.0	0.154	-168.4	2.948	60.6	0.168	72.1	0.351	-61.4
4.0	0.217	163.3	2.318	45.6	0.243	70.0	0.328	-82.1
5.0	0.337	148.9	1.976	31.1	0.322	62.4	0.294	-110.3

$V_{CE} = 2\text{ V}$, $I_C = 10\text{ mA}$, $Z_o = 50\ \Omega$

Frequency (GHz)	S ₁₁		S ₂₁		S ₁₂		S ₂₂	
	MAG.	ANG. (deg.)	MAG.	ANG. (deg.)	MAG.	ANG. (deg.)	MAG.	ANG. (deg.)
0.1	0.708	-13.4	21.482	164.6	0.012	83.9	0.938	-9.6
0.2	0.643	-26.6	19.762	150.5	0.019	77.4	0.874	-17.8
0.3	0.575	-37.8	17.645	138.9	0.027	72.9	0.797	-24.1
0.4	0.501	-46.7	15.589	129.7	0.033	70.5	0.721	-28.4
0.5	0.433	-53.9	13.747	122.0	0.039	69.2	0.655	-31.3
0.6	0.379	-59.3	12.249	116.1	0.044	68.5	0.601	-33.5
0.7	0.336	-65.3	11.000	111.0	0.049	68.8	0.557	-34.9
0.8	0.299	-69.9	9.923	106.5	0.054	69.1	0.521	-36.1
0.9	0.265	-74.1	9.007	102.7	0.059	69.6	0.490	-37.1
1.0	0.236	-79.3	8.255	99.4	0.064	70.2	0.466	-37.9
1.1	0.214	-83.3	7.626	96.2	0.069	70.4	0.444	-38.8
1.2	0.191	-87.5	7.063	93.6	0.074	70.9	0.427	-39.6
1.3	0.175	-92.5	6.595	91.0	0.079	71.3	0.412	-40.6
1.4	0.160	-96.7	6.163	88.5	0.084	71.5	0.400	-41.5
1.5	0.147	-102.3	5.803	86.2	0.089	71.8	0.389	-42.4
1.6	0.136	-108.2	5.468	84.1	0.094	72.0	0.380	-43.5
1.7	0.129	-113.6	5.173	82.1	0.099	72.2	0.372	-44.5
1.8	0.125	-119.7	4.929	80.1	0.105	72.4	0.365	-45.4
1.9	0.121	-125.2	4.690	78.4	0.110	72.5	0.359	-46.6
2.0	0.117	-131.0	4.476	76.7	0.115	72.4	0.353	-47.6
2.1	0.116	-132.7	4.266	75.1	0.121	72.6	0.349	-48.7
2.2	0.116	-139.0	4.102	73.3	0.126	72.4	0.344	-50.0
2.3	0.114	-143.8	3.933	71.6	0.133	72.4	0.341	-51.0
2.4	0.112	-148.3	3.792	69.9	0.139	72.1	0.337	-52.3
2.5	0.115	-152.2	3.650	68.2	0.144	72.1	0.333	-53.3
2.6	0.115	-156.9	3.530	66.9	0.150	71.9	0.330	-54.8
2.7	0.118	-162.0	3.402	65.3	0.156	71.7	0.327	-56.0
2.8	0.117	-165.0	3.301	63.8	0.162	71.5	0.324	-57.4
2.9	0.119	-169.2	3.190	62.4	0.168	71.2	0.322	-59.2
3.0	0.123	-172.8	3.091	60.8	0.175	71.0	0.321	-60.2
4.0	0.191	160.7	2.417	46.7	0.248	68.1	0.294	-81.3
5.0	0.310	148.4	2.065	32.7	0.322	60.4	0.254	-110.2

$V_{CE} = 2\text{ V}$, $I_C = 20\text{ mA}$, $Z_o = 50\ \Omega$

Frequency (GHz)	S ₁₁		S ₂₁		S ₁₂		S ₂₂	
	MAG.	ANG. (deg.)	MAG.	ANG. (deg.)	MAG.	ANG. (deg.)	MAG.	ANG. (deg.)
0.1	0.573	-16.8	29.364	160.0	0.008	90.2	0.897	-12.4
0.2	0.485	-31.3	25.742	143.3	0.017	77.0	0.801	-21.8
0.3	0.411	-41.9	21.722	130.9	0.024	74.8	0.705	-27.7
0.4	0.350	-49.1	18.424	121.9	0.030	73.9	0.622	-31.1
0.5	0.294	-55.4	15.761	114.8	0.036	73.6	0.559	-32.9
0.6	0.249	-60.4	13.774	109.6	0.042	73.9	0.510	-34.1
0.7	0.219	-63.9	12.164	105.0	0.048	73.8	0.472	-34.8
0.8	0.189	-68.0	10.865	101.4	0.053	74.6	0.442	-35.3
0.9	0.165	-71.1	9.776	98.1	0.059	74.8	0.418	-35.8
1.0	0.145	-75.9	8.919	95.2	0.064	75.1	0.399	-36.3
1.1	0.127	-79.6	8.197	92.6	0.070	75.1	0.382	-37.1
1.2	0.114	-84.0	7.557	90.1	0.076	75.3	0.368	-37.7
1.3	0.100	-89.6	7.037	87.9	0.082	75.3	0.356	-38.6
1.4	0.089	-95.0	6.572	85.8	0.088	75.1	0.346	-39.5
1.5	0.080	-100.3	6.163	83.7	0.093	75.0	0.338	-40.4
1.6	0.073	-107.5	5.794	81.9	0.099	74.9	0.331	-41.5
1.7	0.073	-114.2	5.478	80.2	0.105	74.9	0.324	-42.6
1.8	0.067	-123.7	5.216	78.6	0.111	74.6	0.318	-43.6
1.9	0.066	-130.1	4.946	77.1	0.117	74.3	0.313	-44.8
2.0	0.067	-138.0	4.734	75.5	0.123	74.0	0.308	-45.7
2.1	0.067	-140.1	4.506	74.0	0.129	73.7	0.304	-46.8
2.2	0.067	-149.2	4.328	72.5	0.134	73.3	0.299	-48.2
2.3	0.068	-154.6	4.146	70.9	0.141	73.0	0.297	-49.2
2.4	0.068	-159.0	3.995	69.4	0.147	72.5	0.293	-50.5
2.5	0.070	-163.7	3.844	67.9	0.153	72.3	0.290	-51.5
2.6	0.074	-169.7	3.715	66.5	0.160	72.0	0.286	-52.8
2.7	0.077	-173.0	3.584	65.1	0.166	71.5	0.284	-54.2
2.8	0.080	-176.1	3.472	63.7	0.172	71.1	0.280	-55.6
2.9	0.084	178.0	3.356	62.5	0.178	70.6	0.278	-57.4
3.0	0.086	174.7	3.251	61.0	0.185	70.2	0.278	-58.6
4.0	0.162	155.5	2.530	47.8	0.256	65.9	0.249	-81.3
5.0	0.278	146.1	2.157	34.7	0.326	57.8	0.202	-112.0

PACKAGE DIMENSIONS

3-PIN LEAD-LESS MINIMOLD (UNIT: mm)

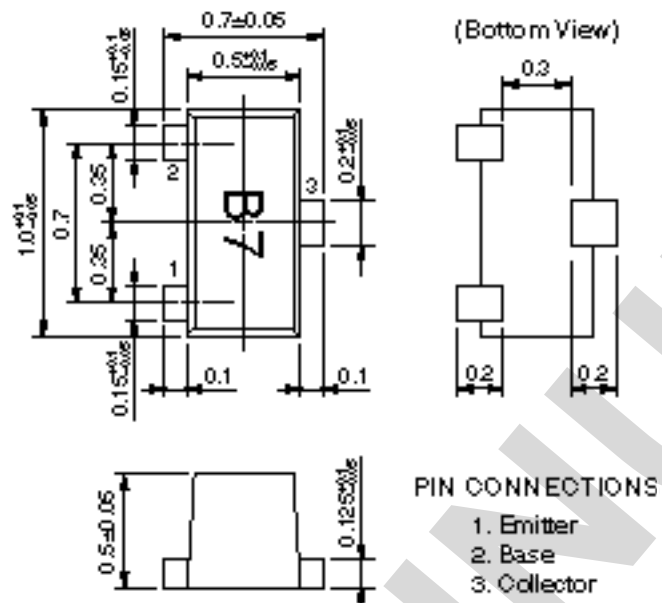

DISCONTINUED