

**FEATURES**

- ※ Low profile 1.6mm height
- ※ Gold contact for high reliability
- ※ Top tape type for washing process

**APPLICATION**

- ※ Industrial control
- ※ Automatic machines control
- ※ NB, electronic devices

**SPECIFICATION**

Contact Rating	25mA, 24V DC
Contact Resistance	100mΩ max.
Insulation Resistance	100MΩ min. 500V DC
Dielectric Strength	300V AC/1 minute
Operating Force	500gf max.
Travel	0.6mm
Operating Life	1,000 cycles
Operating Temp.	-40°C ~ +85°C
Storage Temp.	-40°C ~ +85°C

**HOW TO ORDER**

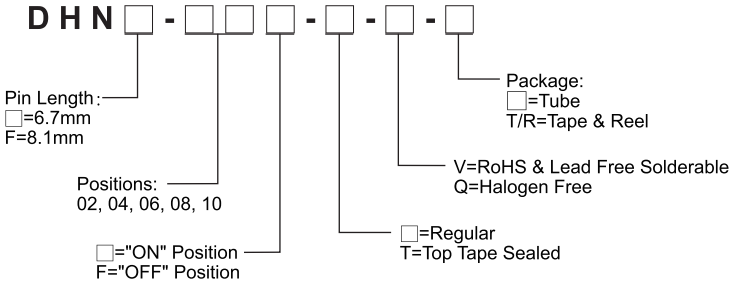

**CIRCUIT**

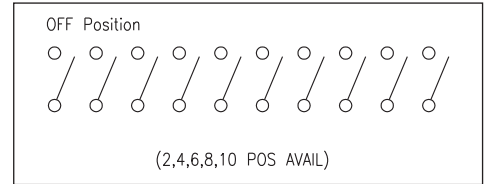

**PACKAGE**

- <Tube>**  
 DHN(F)-02(-T): 125 pcs  
 DHN(F)-04(-T): 75 pcs  
 DHN(F)-06(-T): 54 pcs  
 DHN(F)-08(-T): 40 pcs  
 DHN(F)-10(-T): 33 pcs
- <Tape & Reel>**  
 DHN: 4000 pcs  
 DHNF: 2500 pcs

**DHN**

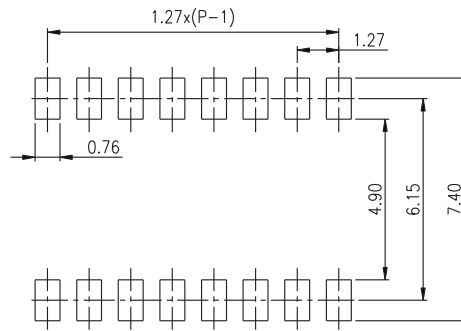
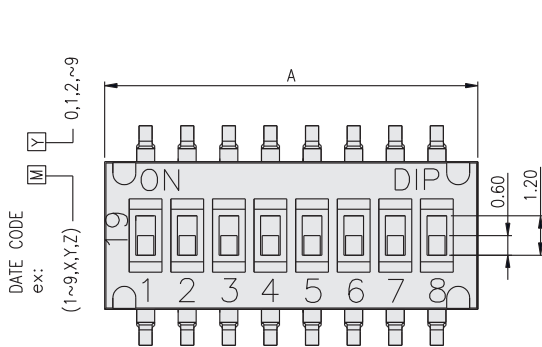

P.C.B. LAYOUT

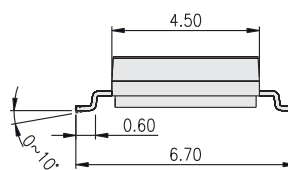
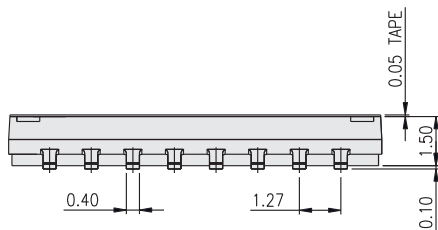

PART NO.	NO.OF POS	DIM A
DHN-02	2	3.77
DHN-04	4	6.31
DHN-06	6	8.85
DHN-08	8	11.39
DHN-10	10	13.93

DHNF

DIP SWITCH

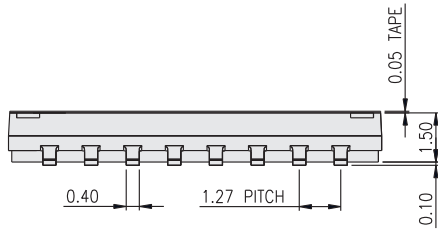
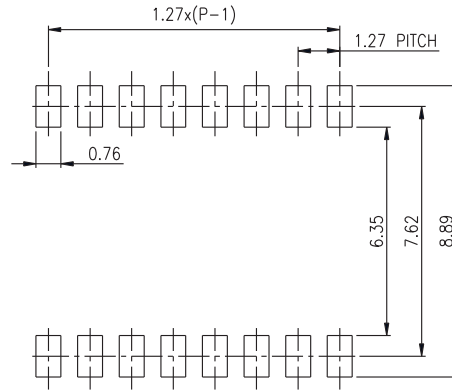
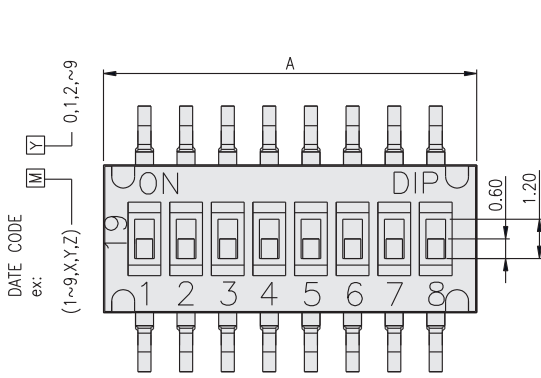

P.C.B. LAYOUT

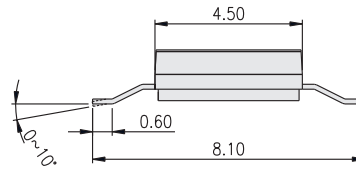

PART NO.	NO.OF POS	DIM A
DHNF-02	2	3.77
DHNF-04	4	6.31
DHNF-06	6	8.85
DHNF-08	8	11.39
DHNF-10	10	13.93