

FEATURES

- ※Side actuation
- ※End stackable
- ※Through hole or SMT

APPLICATION

- ※Industrial control
- ※Automatic machines control
- ※Telecommunication

SPECIFICATION

Contact Rating	25mA, 24V DC
Contact Resistance	100mΩ max.
Insulation Resistance	100MΩ min. 500V DC
Dielectric Strength	500V AC/1 minute
Operating Force	800gf max.
Travel	1mm
Operating Life	2,000 cycles
Operating Temp.	-20°C ~ +85°C
Storage Temp.	-40°C ~ +85°C

CIRCUIT

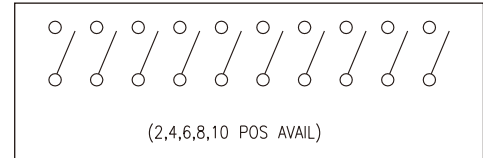

PACKAGE

- <Tube>**
 EP□(R)-02: 95 pcs
 EP□(R)-04: 47 pcs
 EP□(R)-06: 31 pcs
 EP□(R)-08: 23 pcs
 EP□(R)-10: 18 pcs
<Tape & Reel>
 EPM(R): 700 pcs

DIP SWITCH

HOW TO ORDER

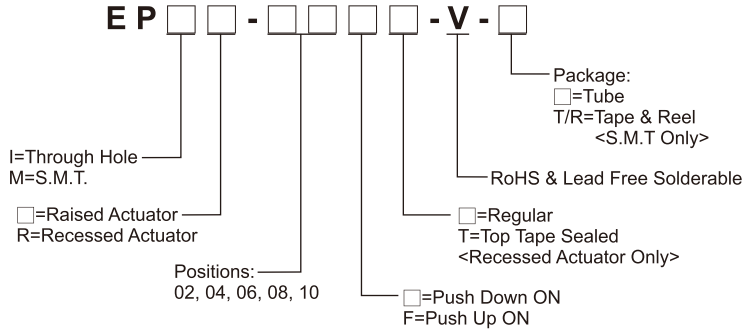

EPI(R)

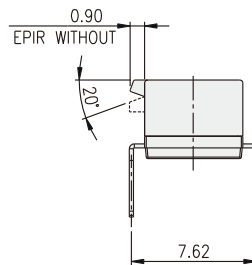
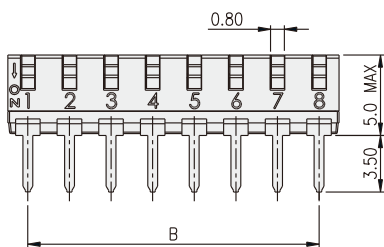
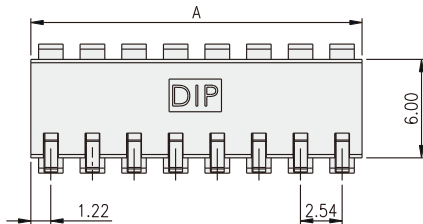

PART NO.	NO.OF POS.	DIM.A	DIM.B
EPI(R)-02	2	4.98	2.54
EPI(R)-04	4	10.06	7.62
EPI(R)-06	6	15.14	12.70
EPI(R)-08	8	20.22	17.78
EPI(R)-10	10	25.30	22.86

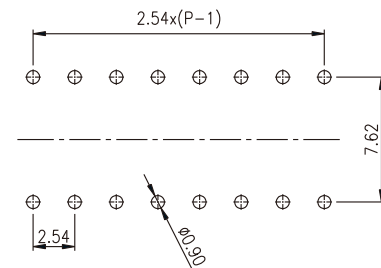

P.C.B. LAYOUT

EPM(R)

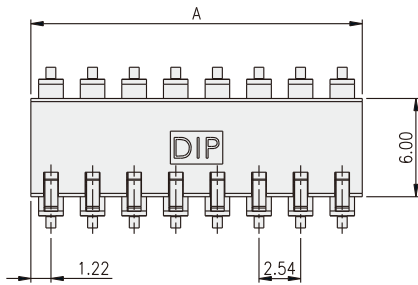

PART NO.	NO.OF POS.	DIM.A	DIM.B
EPM(R)-02	2	4.98	2.54
EPM(R)-04	4	10.06	7.62
EPM(R)-06	6	15.14	12.70
EPM(R)-08	8	20.22	17.78
EPM(R)-10	10	25.30	22.86

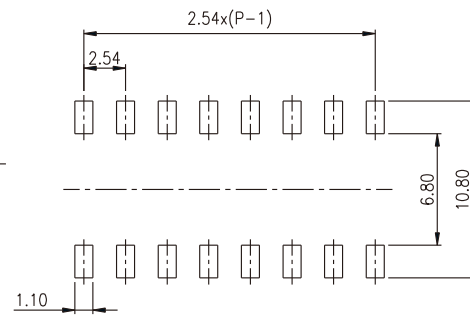
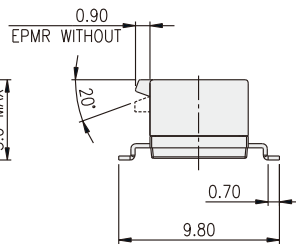
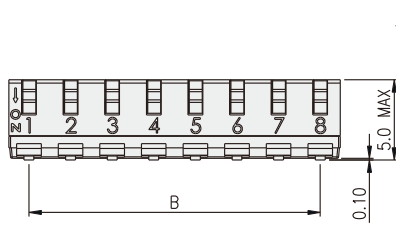

P.C.B. LAYOUT