

# TACT SWITCH DTS(M)(J)-6 SERIES

## 6x6 Surface Mounting Type (Ground Terminal Optional)

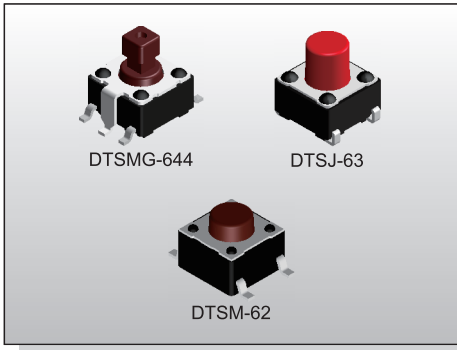

### FEATURES

- ✘ 6x6mm, surface mounting type
- ✘ Optional ground pin
- ✘ Reflow solderable

### APPLICATION

- ✘ Audio, OA equipment
- ✘ Instrumentation, Communication
- ✘ White goods

### SPECIFICATION

Contact Rating	50mA, 12V DC
Contact Resistance	100mΩ max.
Insulation Resistance	100MΩ min. 500V DC
Dielectric Strength	250V AC/1 minute
Operating Force	100±50gf, Black(K) 160±50gf, Brown(N) 260±50gf, Red(R) 320±80gf, Salmon(S) 520±130gf, Yellow(Y)
Travel	0.25mm
Operating Life	<b>Phosphor Bronze Dome</b> 50,000 cycles for 520/320gf 100,000 cycles for 260gf 200,000 cycles for 160/100
	<b>Stainless Steel Dome</b> 300,000 cycles for 520/320gf 500,000 cycles for 260gf 1,000,000 cycles for 160/100gf
Operating Temp.	-25°C ~ +70°C
Storage Temp.	-30°C ~ +80°C

### HOW TO ORDER

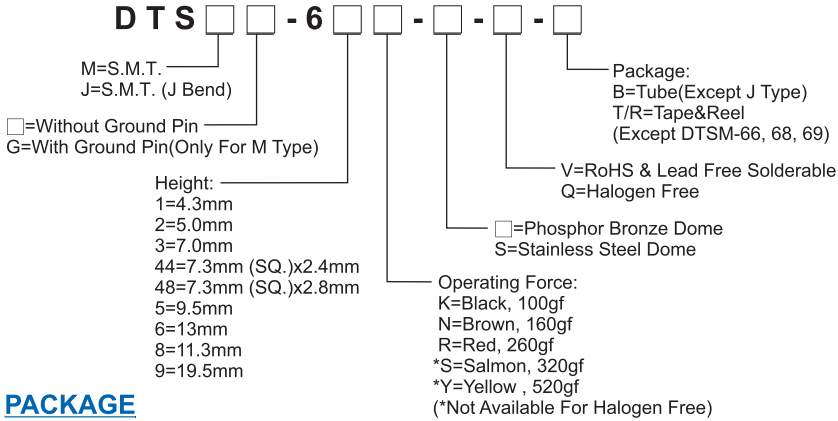

### CIRCUIT

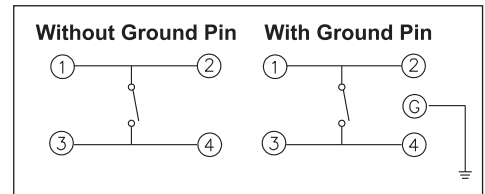

### PACKAGE

<Tube>

77 pcs

<Tape & Reel>

DTSM(G)-61 / DTSMG-62:1000 pcs

DTSM-62:900 pcs      DTSM(G)-63, 64:700 pcs

DTSM(G)-65:380 pcs

### DTSM-6

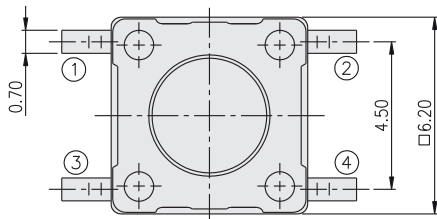

PART NO.	H
DTSM-61	4.30
DTSM-62	5.00
DTSM-63	7.00
DTSM-65	9.50
DTSM-66	13.00
DTSM-68	11.30
DTSM-69	19.50

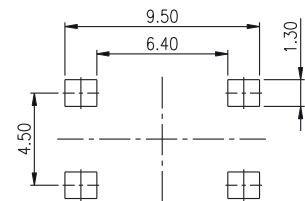
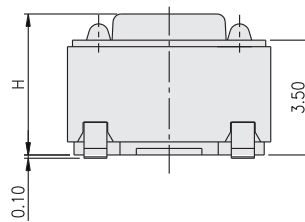
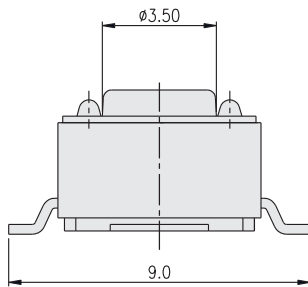

P.C.B. LAYOUT

**DTSM-644(8)**

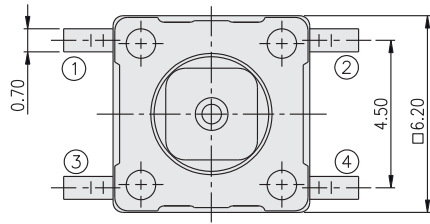

PART NO.	□A	□B
DTSM-644	2.40	1.60
DTSM-648	2.80	2.00

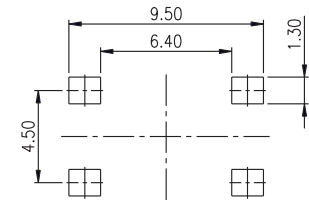
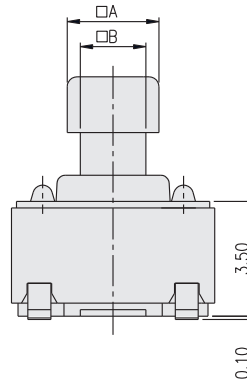
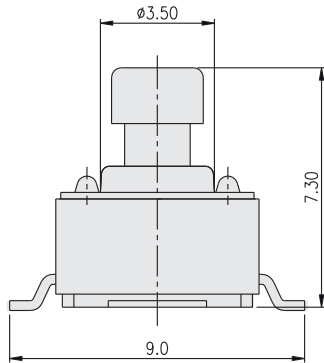

P.C.B. LAYOUT

TACT SWITCH

**DTSMG-6**

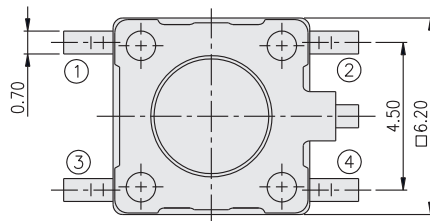

PART NO.	H
DTSMG-61	4.30
DTSMG-62	5.00
DTSMG-63	7.00
DTSMG-65	9.50
DTSMG-66	13.00
DTSMG-68	11.30
DTSMG-69	19.50

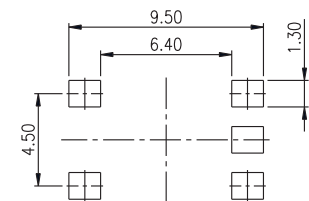
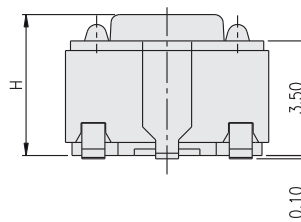
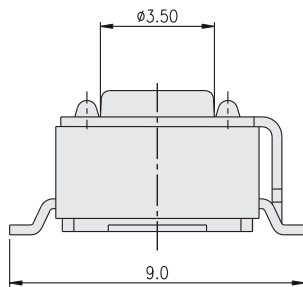

P.C.B. LAYOUT

**DTSJ-6**

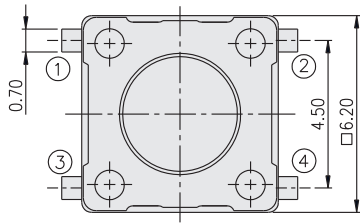

PART NO.	H
DTSJ-61	4.30
DTSJ-62	5.00
DTSJ-63	7.00
DTSJ-65	9.50
DTSJ-66	13.00
DTSJ-68	11.30
DTSJ-69	19.50

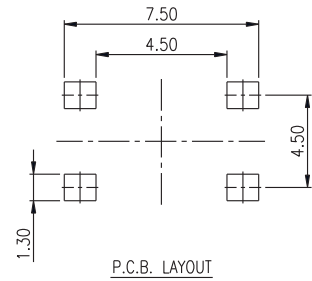
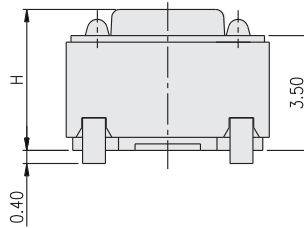
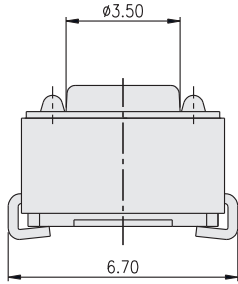

TACT SWITCH