

# DRA73, DRA74, DRA124, DRA125 & DRA127 Series High Power Density, High Efficiency Shielded Inductors for Automotive Applications

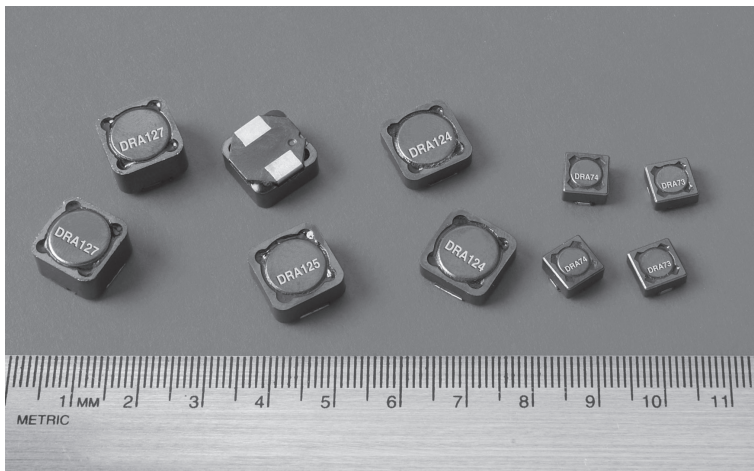

## Applications

- Automotive electronics (under hood, interior/ exterior)
- Telematics
- GPS
- LED Lighting
- LCD Display
- Portable media devices

## Environmental data

- Storage temperature range (component): -40°C to +165°C
- Operating temperature range: -40°C to +165°C (ambient + self-temperature rise)
- Solder reflow temperature: J-STD-020D compliant
- Complies with AEC-Q200 standard

## Description

- Halogen free, lead free, RoHS compliant
- 165°C Maximum total temperature operation
- Five different mechanical sizes available
- Magnetically shielded-reduces EMI
- Ferrite core material
- Inductance range from 0.28µH to 1000µH
- Current range up to 56 amps
- Rugged construction for high shock and vibration environments

## Packaging

- Supplied in tape-and-reel packaging on a 13 inch diameter reel



Powering Business Worldwide



The Coiltronics brand of magnetics (formerly of the Bussmann Division of Cooper Industries) is now part of Eaton's Electrical Group, Electronics Division.

**Coiltronics is now part of Eaton**  
**Same great products plus even more.**

### Product specifications

DRA73 Series - 7.6 x 7.6 x 3.55mm

Part Number <sup>6</sup>	OCL <sup>1</sup> ±20% (µH)	I <sub>rms</sub> <sup>2</sup> (Amps)	I <sub>sat</sub> 1 <sup>3</sup> (Amps)	I <sub>sat</sub> 2 <sup>4</sup> (Amps)	DCR (Ω) @ 25°C Typical	DCR (Ω) @ 25°C Maximum	K-Factor <sup>5</sup>
DRA73-R33-R	0.29	8.42	14.8	11.8	0.0040	0.0048	636.5
DRA73-1R0-R	0.91	6.50	8.22	6.58	0.0067	0.0080	353.6
DRA73-1R5-R	1.36	5.39	6.73	5.38	0.0097	0.0117	289.3
DRA73-2R2-R	2.52	4.18	4.93	3.95	0.016	0.019	212.2
DRA73-3R3-R	3.18	3.59	4.35	3.48	0.022	0.026	187.2
DRA73-4R7-R	4.86	2.92	3.52	2.82	0.033	0.040	151.6
DRA73-6R8-R	6.63	2.62	2.96	2.37	0.041	0.049	127.3
DRA73-8R2-R	8.06	2.30	2.74	2.19	0.053	0.064	117.9
DRA73-100-R	10.27	2.11	2.39	1.91	0.064	0.077	102.7
DRA73-150-R	14.98	1.74	2.00	1.60	0.094	0.112	86.0
DRA73-220-R	22.39	1.42	1.64	1.32	0.141	0.170	70.7
DRA73-330-R	31.84	1.25	1.35	1.08	0.183	0.219	57.9
DRA73-470-R	47.83	1.02	1.10	0.884	0.275	0.330	47.5
DRA73-680-R	66.89	0.845	0.937	0.749	0.397	0.476	40.3
DRA73-820-R	83.77	0.731	0.851	0.680	0.530	0.636	36.6
DRA73-101-R	101.7	0.682	0.763	0.610	0.609	0.731	32.8
DRA73-151-R	151.1	0.551	0.632	0.506	0.932	1.12	27.2
DRA73-221-R	218.8	0.479	0.510	0.408	1.23	1.48	21.9
DRA73-331-R	326.4	0.391	0.423	0.338	1.85	2.22	18.2
DRA73-471-R	472.6	0.326	0.354	0.283	2.67	3.20	15.2
DRA73-681-R	682.9	0.270	0.297	0.238	3.89	4.66	12.8
DRA73-821-R	825.3	0.252	0.267	0.214	4.46	5.35	11.5
DRA73-102-R	991.9	0.235	0.239	0.192	5.15	6.18	10.3

1. Open Circuit Inductance (OCL) Test Parameters: 100kHz, 0.25V<sub>rms</sub>, 0.0Adc @ 25°C
2. I<sub>rms</sub>: DC current for an approximate temperature rise of 40°C without core loss. Derating is necessary for AC currents. PCB layout, trace thickness and width, air-flow and proximity of other heat generating components will affect the temperature rise. It is recommended that the temperature of the part not exceed 165°C under worst case operating conditions verified in the end application.
3. I<sub>sat</sub>1: Peak current for approximately 30% rolloff at +25°C.

4. I<sub>sat</sub>2: Peak current for approximately 40% rolloff at +125°C.
5. K-factor: Used to determine Bp-p for core loss (see graph).  $B_{p-p} = K * L * \Delta I$ . B<sub>p-p</sub>:(Gauss), K: (K-factor from table), L: (Inductance in µH), ΔI (peak-to-peak ripple current in amps).
6. Part Number Definition: DRAxxx-yyy-R
  - DRAxxx = Product code and size
  - yyy= Inductance value in uH, R = decimal point, if no R is present then third character = number of zeros.
  - -R suffix = RoHS compliant1

DRA73, DRA74, DRA124, DRA125 and DRA127 Series

**Product specifications**

DRA74 Series - 7.6 x 7.6 x 4.35mm

Part Number <sup>6</sup>	OCL <sup>1</sup> ±20% (µH)	I <sub>rms</sub> <sup>2</sup> (Amps)	I <sub>sat</sub> 1 <sup>3</sup> (Amps)	I <sub>sat</sub> 2 <sup>4</sup> (Amps)	DCR (Ω) @ 25°C Typical	DCR (Ω) @ 25°C Maximum	K-Factor <sup>5</sup>
DRA74-R33-R	0.29	7.26	18.4	14.7	0.0054	0.0064	547.9
DRA74-1R0-R	0.90	6.01	10.2	8.18	0.0078	0.0094	304.4
DRA74-1R5-R	1.31	5.55	8.36	6.69	0.0092	0.0110	249.0
DRA74-2R2-R	2.33	4.82	6.13	4.91	0.012	0.015	182.6
DRA74-3R3-R	3.05	4.16	5.41	4.33	0.016	0.020	161.1
DRA74-4R7-R	4.68	3.41	4.38	3.50	0.024	0.029	130.4
DRA74-6R8-R	6.51	2.91	3.68	2.94	0.034	0.040	109.6
DRA74-8R2-R	8.51	2.66	3.17	2.54	0.040	0.048	94.5
DRA74-100-R	9.62	2.56	2.97	2.37	0.043	0.052	88.4
DRA74-150-R	15.14	2.06	2.36	1.89	0.067	0.080	70.2
DRA74-220-R	22.25	1.68	1.96	1.57	0.100	0.120	58.3
DRA74-330-R	33.21	1.37	1.61	1.29	0.151	0.181	48.1
DRA74-470-R	46.56	1.14	1.37	1.10	0.219	0.263	40.9
DRA74-680-R	68.37	0.996	1.11	0.887	0.286	0.343	33.0
DRA74-820-R	81.45	0.879	1.03	0.827	0.367	0.440	30.8
DRA74-101-R	98.50	0.822	0.929	0.743	0.419	0.503	27.7
DRA74-151-R	150.9	0.661	0.748	0.598	0.648	0.780	22.3
DRA74-221-R	218.9	0.544	0.626	0.501	0.960	1.15	18.6
DRA74-331-R	328.9	0.435	0.514	0.411	1.50	1.79	15.3
DRA74-471-R	471.5	0.383	0.420	0.336	1.93	2.31	12.5
DRA74-681-R	682.8	0.315	0.352	0.282	2.86	3.43	10.5
DRA74-821-R	815.0	0.279	0.327	0.262	3.63	4.35	9.7
DRA74-102-R	1001.7	0.260	0.292	0.234	4.19	5.02	8.7

1. Open Circuit Inductance (OCL) Test Parameters: 100kHz, 0.25V<sub>rms</sub>, 0.0Adc @ 25°C
2. I<sub>rms</sub>: DC current for an approximate temperature rise of 40°C without core loss. Derating is necessary for AC currents. PCB layout, trace thickness and width, air-flow and proximity of other heat generating components will affect the temperature rise. It is recommended that the temperature of the part not exceed 165°C under worst case operating conditions verified in the end application.
3. I<sub>sat</sub>1: Peak current for approximately 30% rolloff at +25°C.

4. I<sub>sat</sub>2: Peak current for approximately 40% rolloff at +125°C.
5. K-factor: Used to determine Bp-p for core loss (see graph).  $B_{p-p} = K * L * \Delta I$ . B<sub>p-p</sub>:(Gauss), K: (K-factor from table), L: (Inductance in µH), ΔI (peak-to-peak ripple current in amps).
6. Part Number Definition: DRAxxx-yyy-R
  - DRAxxx = Product code and size
  - yyy= Inductance value in uH, R = decimal point, if no R is present then third character = number of zeros.
  - -R suffix = RoHS compliant1

### Product specifications

DRA124 Series - 12.5 x 12.5 x 4.5mm

Part Number <sup>6</sup>	OCL <sup>1</sup> ±20% (µH)	I <sub>rms</sub> <sup>2</sup> (Amps)	I <sub>sat</sub> 1 <sup>3</sup> (Amps)	I <sub>sat</sub> 2 <sup>4</sup> (Amps)	DCR (Ω) @ 25°C Typical	DCR (Ω) @ 25°C Maximum	K-Factor <sup>5</sup>
DRA124-R47-R	0.42	13.5	30.8	24.6	0.0024	0.0028	196.9
DRA124-1R0-R	0.82	11.7	22.0	17.6	0.0031	0.0038	140.7
DRA124-1R5-R	1.36	9.36	17.1	13.7	0.0049	0.0058	109.4
DRA124-2R2-R	2.04	7.64	14.0	11.2	0.0070	0.0090	89.5
DRA124-3R3-R	2.79	6.94	11.9	9.48	0.0090	0.011	75.7
DRA124-4R7-R	4.74	5.47	9.06	7.25	0.014	0.017	57.9
DRA124-6R8-R	7.28	4.46	7.33	5.87	0.021	0.026	46.9
DRA124-8R2-R	8.88	3.87	6.70	5.36	0.028	0.034	42.8
DRA124-100-R	10.37	3.67	6.16	4.93	0.031	0.038	39.4
DRA124-150-R	14.10	3.10	5.31	4.25	0.044	0.053	34.0
DRA124-220-R	23.00	2.44	4.16	3.33	0.071	0.086	26.6
DRA124-330-R	34.13	1.98	3.42	2.74	0.108	0.130	21.9
DRA124-470-R	46.27	1.78	2.91	2.33	0.134	0.160	18.6
DRA124-680-R	69.77	1.45	2.37	1.90	0.201	0.241	15.1
DRA124-820-R	80.57	1.29	2.23	1.79	0.257	0.309	14.3
DRA124-101-R	98.80	1.20	2.00	1.60	0.296	0.355	12.8
DRA124-151-R	151.7	0.967	1.62	1.30	0.454	0.550	10.4
DRA124-221-R	209.6	0.865	1.36	1.09	0.568	0.680	8.7
DRA124-331-R	326.9	0.690	1.09	0.874	0.892	1.070	7.0
DRA124-471-R	473.0	0.568	0.911	0.729	1.32	1.58	5.8
DRA124-681-R	682.1	0.466	0.759	0.607	1.96	2.35	4.9
DRA124-821-R	826.7	0.406	0.697	0.557	2.57	3.09	4.5
DRA124-102-R	1001.0	0.380	0.629	0.503	2.94	3.52	4.0

1. Open Circuit Inductance (OCL) Test Parameters: 100kHz, 0.25V<sub>rms</sub>, 0.0Adc @ 25°C
2. I<sub>rms</sub>: DC current for an approximate temperature rise of 40°C without core loss. Derating is necessary for AC currents. PCB layout, trace thickness and width, air-flow and proximity of other heat generating components will affect the temperature rise. It is recommended that the temperature of the part not exceed 165°C under worst case operating conditions verified in the end application.
3. I<sub>sat</sub> 1: Peak current for approximately 30% rolloff at +25°C.

4. I<sub>sat</sub> 2: Peak current for approximately 40% rolloff at +125°C.
5. K-factor: Used to determine B<sub>p-p</sub> for core loss (see graph).  $B_{p-p} = K * L * \Delta I$ . B<sub>p-p</sub>:(Gauss), K: (K-factor from table), L: (Inductance in µH), ΔI (peak-to-peak ripple current in amps).
6. Part Number Definition: DRAXxx-yyy-R
  - DRAXxx = Product code and size
  - yyy= Inductance value in µH, R = decimal point, if no R is present then third character = number of zeros.
  - -R suffix = RoHS compliant1

**Product specifications**

DRA125 Series - 12.5 x 12.5 x 6.0mm

Part Number <sup>6</sup>	OCL <sup>1</sup> ±20% (μH)	I <sub>rms</sub> <sup>2</sup> (Amps)	I <sub>sat</sub> 1 <sup>3</sup> (Amps)	I <sub>sat</sub> 2 <sup>4</sup> (Amps)	DCR (Ω) @ 25°C Typical	DCR (Ω) @ 25°C Maximum	K-Factor <sup>5</sup>
DRA125-R47-R	0.45	14.7	33.2	26.6	0.0025	0.0030	176.9
DRA125-1R0-R	0.85	12.7	23.7	19.0	0.0034	0.0042	126.4
DRA125-1R5-R	1.41	12.9	18.4	14.8	0.0033	0.0039	98.3
DRA125-2R2-R	2.12	10.6	15.1	12.1	0.0048	0.0058	80.4
DRA125-3R3-R	2.89	8.63	12.8	10.2	0.0073	0.0087	68.0
DRA125-4R7-R	4.90	7.67	9.76	7.81	0.0092	0.011	52.0
DRA125-6R8-R	6.23	6.81	8.74	6.99	0.012	0.014	46.6
DRA125-8R2-R	7.49	6.41	7.90	6.32	0.013	0.016	42.1
DRA125-100-R	9.22	5.57	7.22	5.77	0.017	0.021	38.5
DRA125-150-R	14.67	4.45	5.72	4.58	0.027	0.033	30.5
DRA125-220-R	20.65	3.95	4.74	3.79	0.035	0.042	25.3
DRA125-330-R	31.47	3.19	3.86	3.09	0.053	0.064	20.6
DRA125-470-R	47.83	2.59	3.13	2.51	0.081	0.097	16.7
DRA125-680-R	68.48	2.13	2.64	2.11	0.120	0.144	14.0
DRA125-820-R	80.86	2.01	2.41	1.93	0.135	0.162	12.8
DRA125-101-R	97.60	1.75	2.21	1.77	0.178	0.214	11.8
DRA125-151-R	150.0	1.41	1.79	1.43	0.273	0.330	9.5
DRA125-221-R	222.8	1.14	1.47	1.18	0.416	0.500	7.8
DRA125-331-R	325.1	1.00	1.19	0.96	0.543	0.650	6.4
DRA125-471-R	466.3	0.826	1.01	0.805	0.790	0.950	5.4
DRA125-681-R	683.3	0.673	0.834	0.667	1.200	1.440	4.4
DRA125-821-R	813.6	0.632	0.758	0.606	1.360	1.630	4.0
DRA125-102-R	992.8	0.552	0.695	0.556	1.780	2.130	3.7

1. Open Circuit Inductance (OCL) Test Parameters: 100kHz, 0.25V<sub>rms</sub>, 0.0A<sub>dc</sub> @ 25°C
2. I<sub>rms</sub>: DC current for an approximate temperature rise of 40°C without core loss. Derating is necessary for AC currents. PCB layout, trace thickness and width, air-flow and proximity of other heat generating components will affect the temperature rise. It is recommended that the temperature of the part not exceed 165°C under worst case operating conditions verified in the end application.
3. I<sub>sat</sub>1: Peak current for approximately 30% rolloff at +25°C.

4. I<sub>sat</sub>2: Peak current for approximately 40% rolloff at +125°C.
5. K-factor: Used to determine B<sub>p-p</sub> for core loss (see graph).  $B_{p-p} = K * L * \Delta I$ . B<sub>p-p</sub>:(Gauss), K: (K-factor from table), L: (Inductance in μH), ΔI (peak-to-peak ripple current in amps).
6. Part Number Definition: DRAXxx-yyy-R
  - DRAXxx = Product code and size
  - yyy= Inductance value in μH, R = decimal point, if no R is present then third character = number of zeros.
  - -R suffix = RoHS compliant1

**Product specifications**

DRA127 Series - 12.5 x 12.5 x 8.0mm

Part Number <sup>6</sup>	OCL <sup>1</sup> ±20% (µH)	I <sub>rms</sub> <sup>2</sup> (Amps)	I <sub>sat</sub> 1 <sup>3</sup> (Amps)	I <sub>sat</sub> 2 <sup>4</sup> (Amps)	DCR (Ω) @ 25°C Typical	DCR (Ω) @ 25°C Maximum	K-Factor <sup>5</sup>
DRA127-R47-R	0.41	15.9	56.0	44.8	0.0024	0.0030	120.0
DRA127-1R0-R	0.77	13.6	40.0	32.0	0.0034	0.0040	85.7
DRA127-1R5-R	1.27	12.2	31.1	24.9	0.0043	0.0051	66.7
DRA127-2R2-R	1.92	12.5	25.5	20.4	0.0040	0.0048	54.6
DRA127-3R3-R	3.51	8.54	18.7	14.9	0.0086	0.0104	40.0
DRA127-4R7-R	4.58	8.14	16.5	13.2	0.0094	0.011	35.3
DRA127-6R8-R	6.72	6.52	13.3	10.7	0.015	0.018	28.6
DRA127-8R2-R	8.33	6.33	12.2	9.74	0.016	0.019	26.1
DRA127-100-R	9.63	6.02	11.2	8.96	0.017	0.021	24.0
DRA127-150-R	14.90	4.83	9.03	7.23	0.027	0.032	19.4
DRA127-220-R	21.47	3.98	7.57	6.05	0.040	0.047	16.2
DRA127-330-R	32.01	3.22	6.22	4.98	0.060	0.072	13.3
DRA127-470-R	47.91	2.62	5.09	4.07	0.091	0.110	10.9
DRA127-680-R	68.22	2.33	4.18	3.34	0.115	0.138	9.0
DRA127-820-R	83.91	2.01	3.84	3.07	0.155	0.186	8.2
DRA127-101-R	100.8	1.89	3.46	2.77	0.175	0.210	7.4
DRA127-151-R	151.2	1.52	2.83	2.26	0.269	0.320	6.1
DRA127-221-R	219.8	1.25	2.35	1.88	0.398	0.480	5.0
DRA127-331-R	328.3	1.01	1.93	1.54	0.612	0.730	4.1
DRA127-471-R	474.5	0.827	1.62	1.29	0.910	1.10	3.5
DRA127-681-R	676.6	0.736	1.33	1.06	1.15	1.39	2.8
DRA127-821-R	824.6	0.637	1.22	0.978	1.54	1.85	2.6
DRA127-102-R	998.7	0.598	1.10	0.878	1.75	2.10	2.4

1. Open Circuit Inductance (OCL) Test Parameters: 100kHz, 0.25V<sub>rms</sub>, 0.0Adc @ 25°C
2. I<sub>rms</sub><sup>2</sup>: DC current for an approximate temperature rise of 40°C without core loss. Derating is necessary for AC currents. PCB layout, trace thickness and width, air-flow and proximity of other heat generating components will affect the temperature rise. It is recommended that the temperature of the part not exceed 165°C under worst case operating conditions verified in the end application.
3. I<sub>sat</sub> 1: Peak current for approximately 30% rolloff at +25°C.

4. I<sub>sat</sub> 2: Peak current for approximately 40% rolloff at +125°C.
5. K-factor: Used to determine Bp-p for core loss (see graph).  $B_{p-p} = K * L * \Delta I$ . B<sub>p-p</sub>:(Gauss), K: (K-factor from table), L: (Inductance in µH), ΔI (peak-to-peak ripple current in amps).
6. Part Number Definition: DRAxxyy-R
  - DRAxxyy = Product code and size
  - yyy= Inductance value in µH, R = decimal point, if no R is present then third character = number of zeros.
  - -R suffix = RoHS compliant1

**Temperature rise vs. total loss**

DRA73

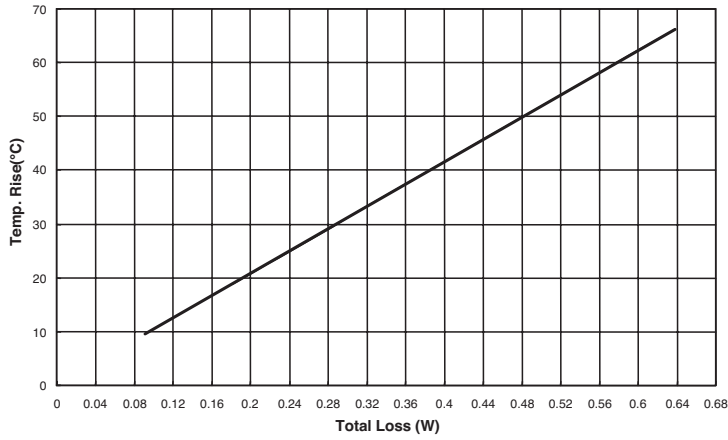

DRA74

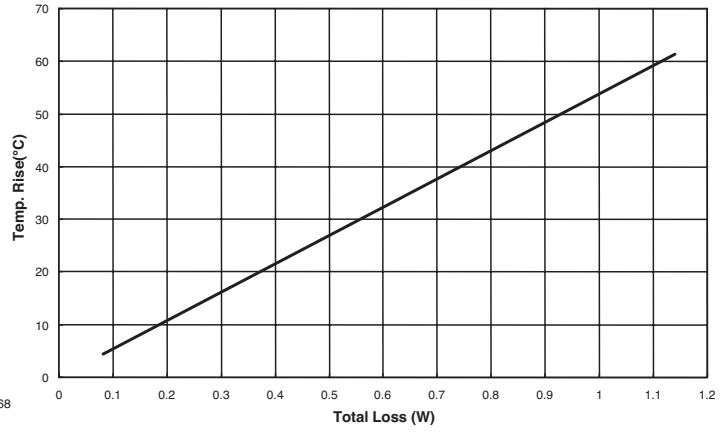

DRA124

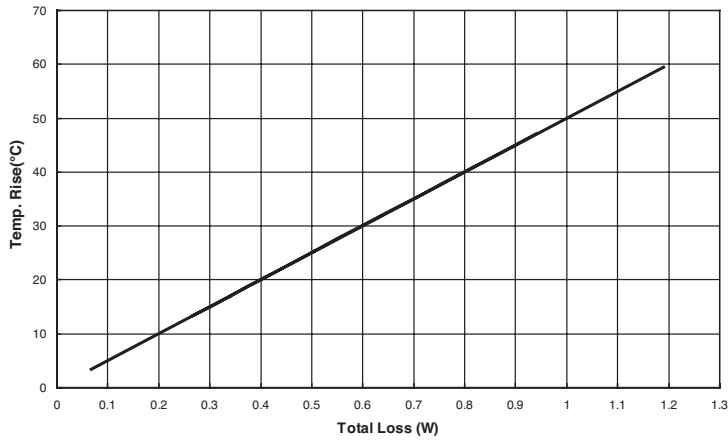

DRA125

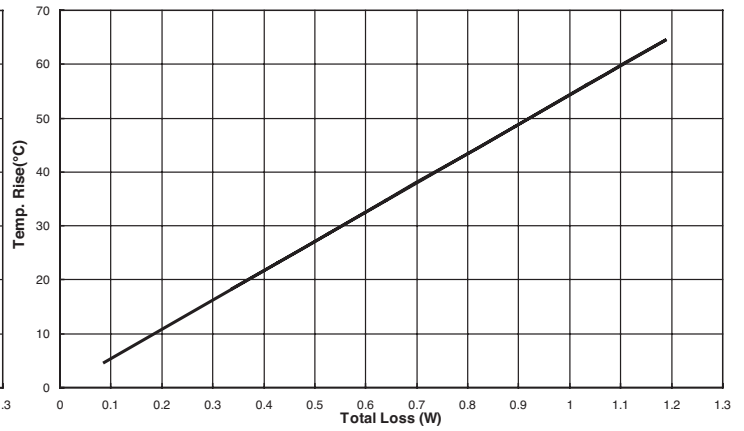

DRA127

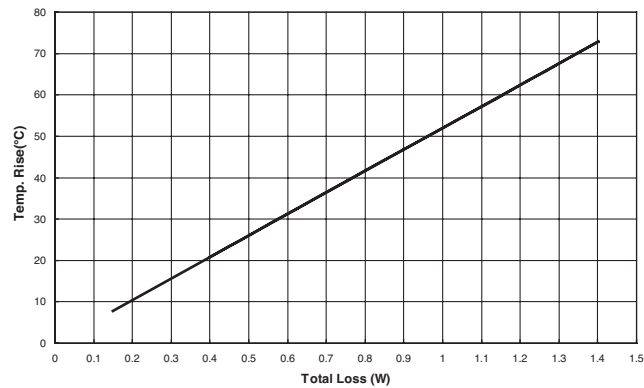

**Core loss**

DRA73

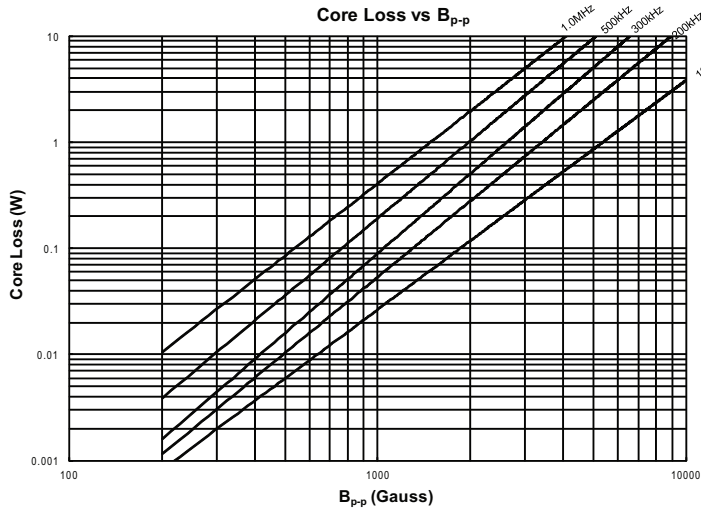

DRA74

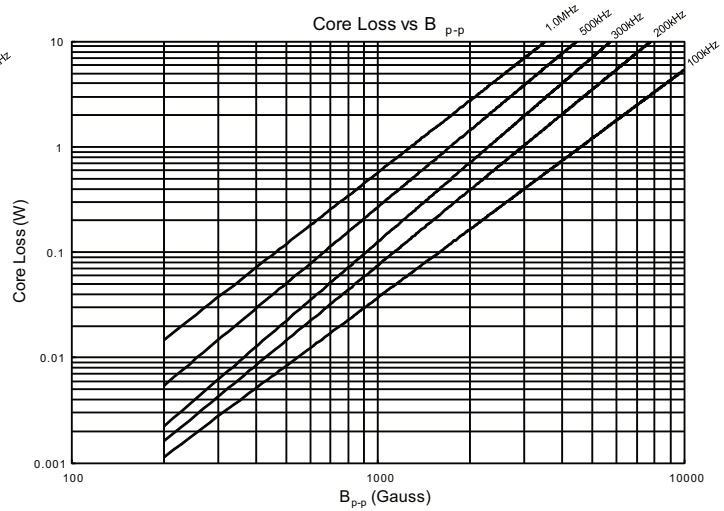

DRA124

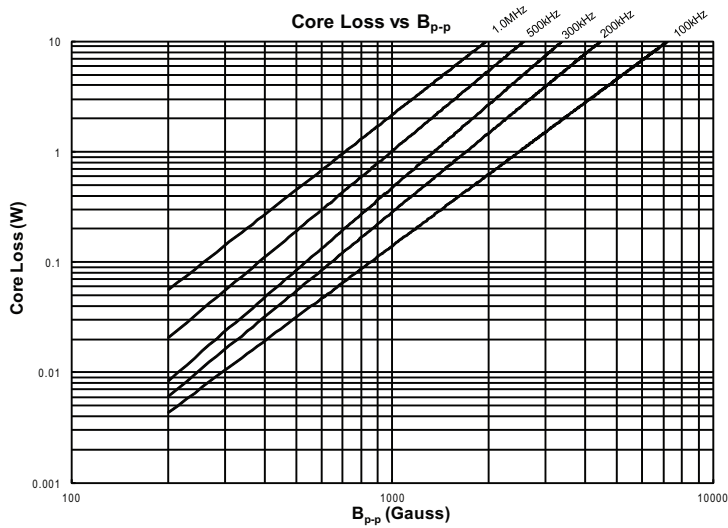

DRA125

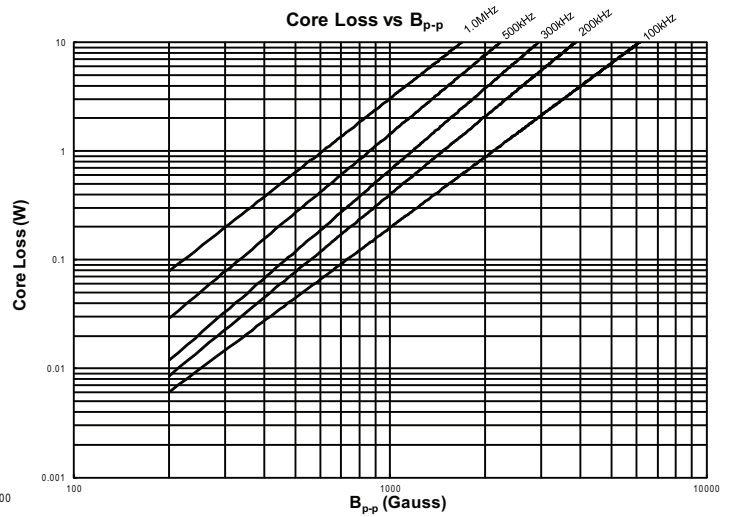

DRA127

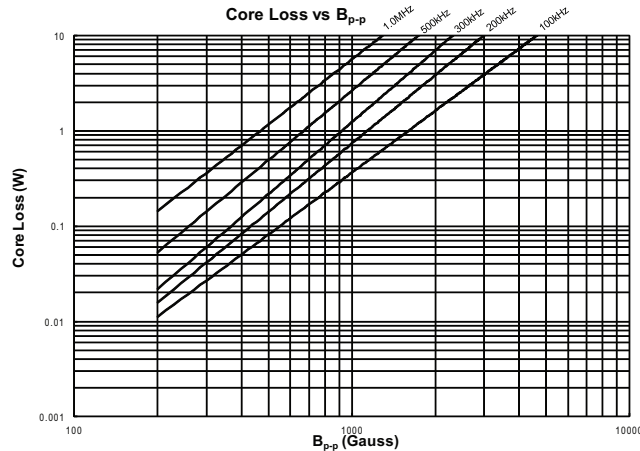



**Inductance characteristics**

DRA73

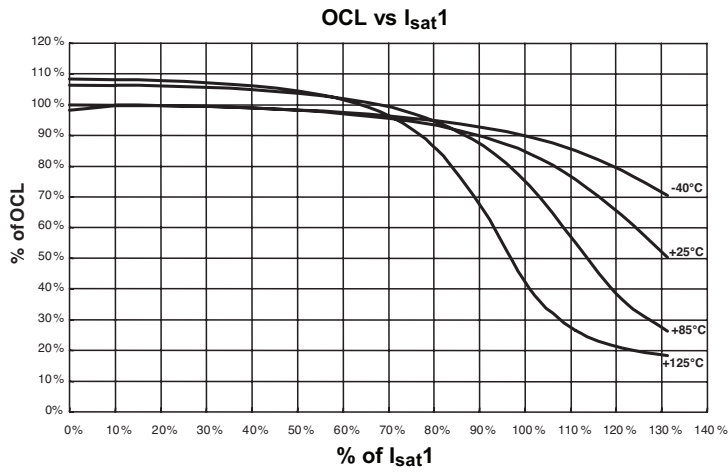

DRA74

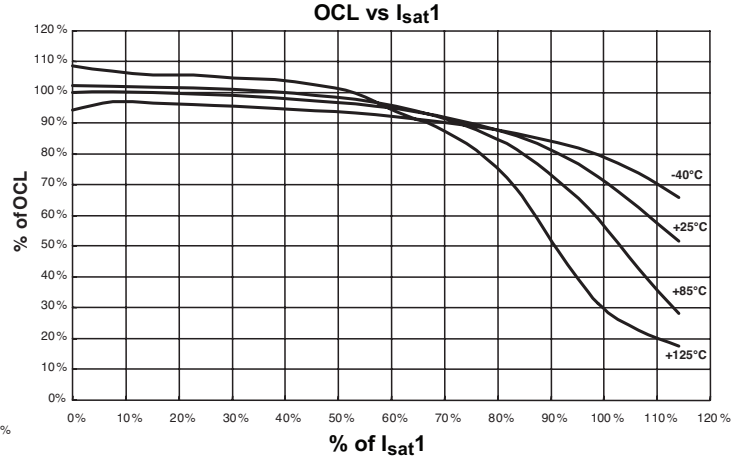

DRA124

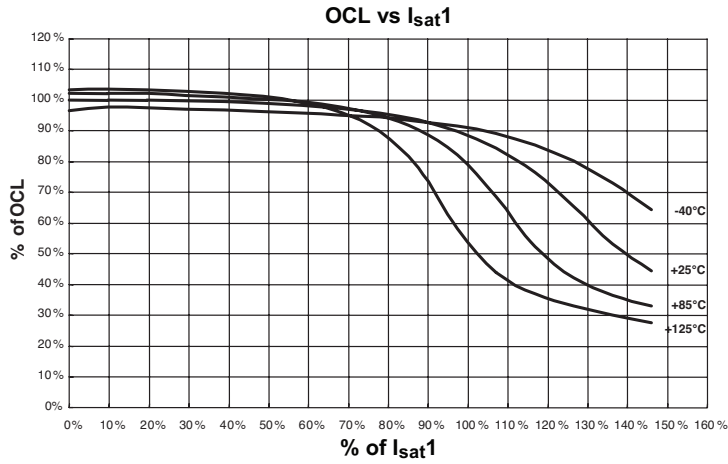

DRA125

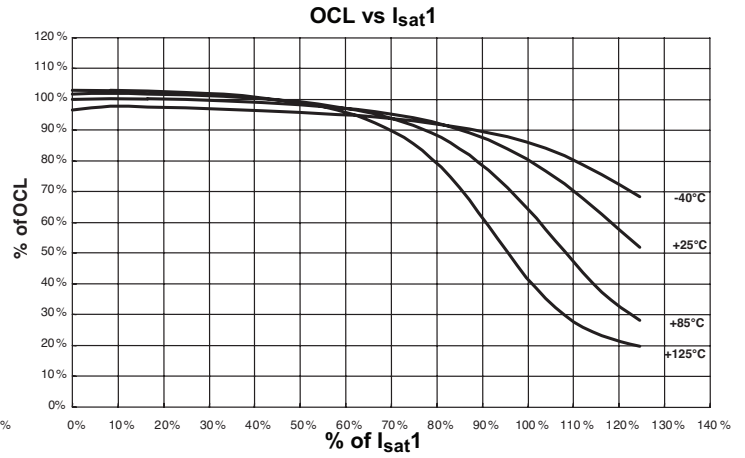

DRA127

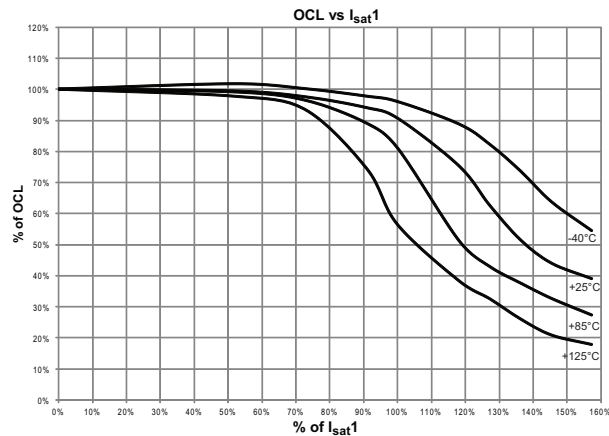

**Dimensions - mm**

**DRA73 & DRA74**

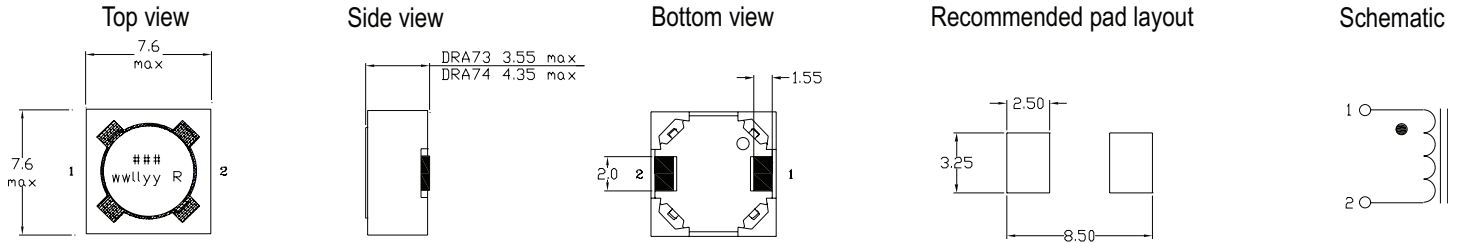

Part Marking: ### = inductance value in  $\mu\text{H}$ , R = decimal point; if no R is present, then 3rd digit equals number of zeros  
wwllyy = Date code, R = revision level  
All soldering surfaces to be coplanar within 0.10 millimeters  
Tolerances are  $\pm 0.2$  millimeters unless stated otherwise.

**DRA124, DRA125 & DRA127**

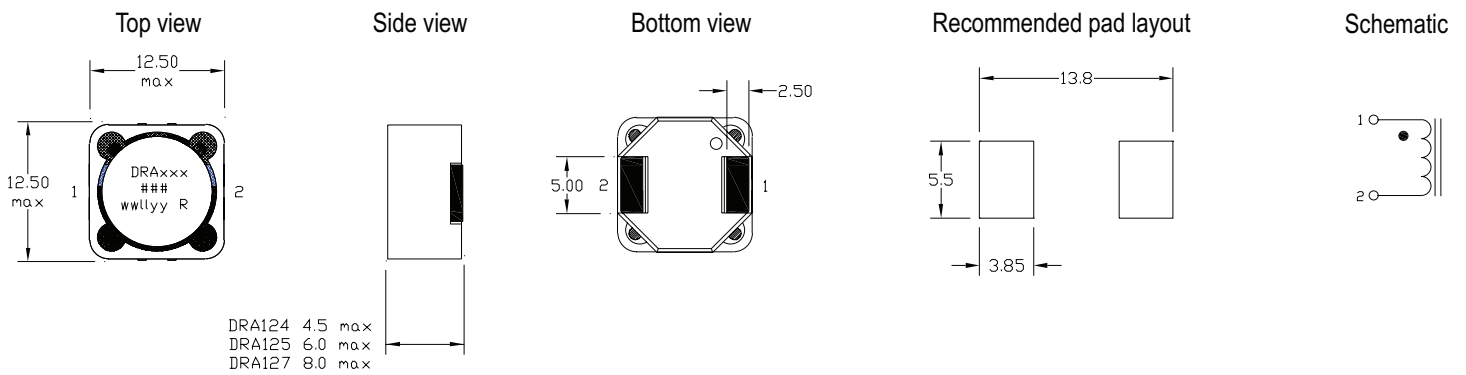

Part Marking: DRAxx, xx = 124, 125 or 127, ### = inductance value in  $\mu\text{H}$ , R = decimal point; if no R is present, then 3rd digit equals number of zeros  
wwllyy = Date code, R = revision level  
All soldering surfaces to be coplanar within 0.10 millimeters  
Tolerances are  $\pm 0.2$  millimeters unless stated otherwise.

**Packaging information - mm**

**DRA73 & DRA74**

Supplied in tape and reel packaging, on a 13" diameter reel:

- DRA73 - 1350 pieces
- DRA74 - 1100 pieces

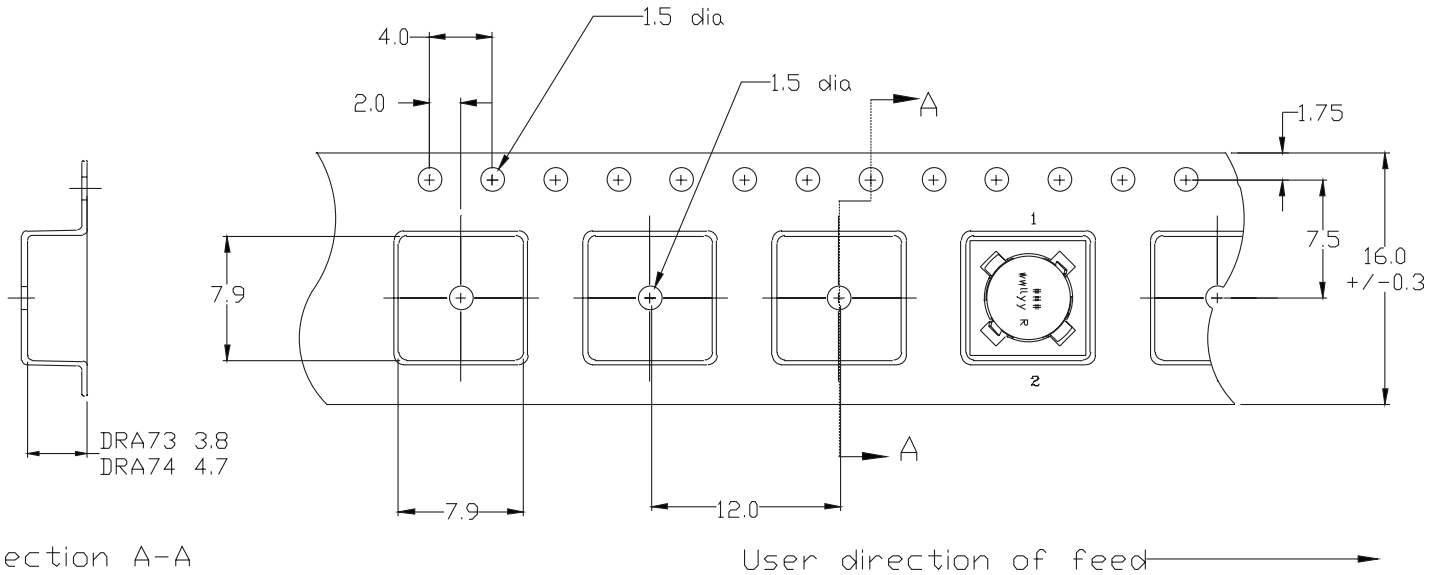

**DRA124, DRA125 & DRA127**

Supplied in tape and reel packaging, on a 13" diameter reel:

- DRA124 - 750 pieces
- DRA125 - 600 pieces
- DRA127 - 350 pieces

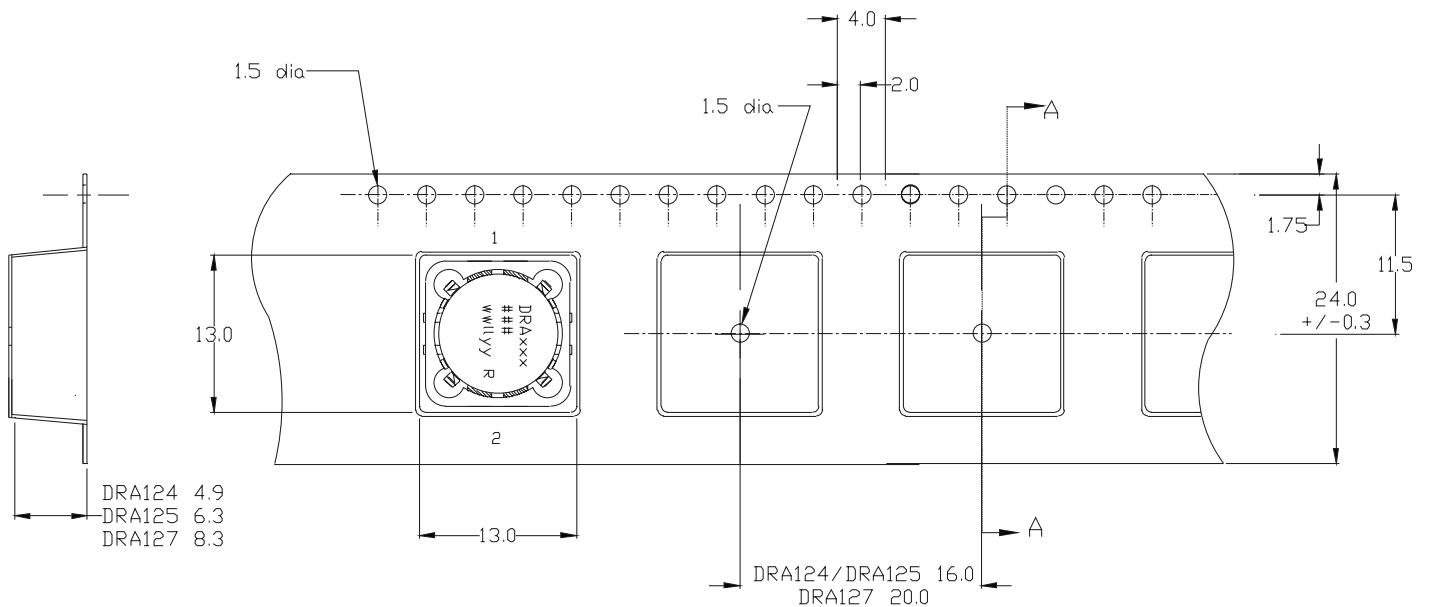

**Solder reflow profile**

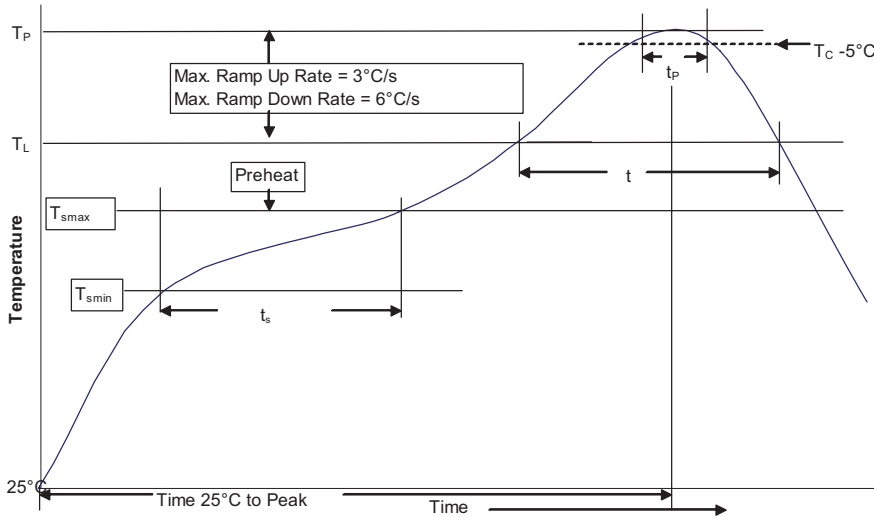

**Table 1 - Standard SnPb Solder (T<sub>c</sub>)**

Package Thickness	Volume <350 mm <sup>3</sup>	Volume ≥350 mm <sup>3</sup>
<2.5mm	235°C	220°C
≥2.5mm	220°C	220°C

**Table 2 - Lead (Pb) Free Solder (T<sub>c</sub>)**

Package Thickness	Volume <350 mm <sup>3</sup>	Volume 350 - 2000 mm <sup>3</sup>	Volume >2000 mm <sup>3</sup>
<1.6mm	260°C	260°C	260°C
1.6 – 2.5mm	260°C	250°C	245°C
>2.5mm	250°C	245°C	245°C

**Reference JDEC J-STD-020D**

Profile Feature	Standard SnPb Solder	Lead (Pb) Free Solder
Preheat and Soak		
• Temperature min. (T <sub>smin</sub> )	100°C	150°C
• Temperature max. (T <sub>smax</sub> )	150°C	200°C
• Time (T <sub>smin</sub> to T <sub>smax</sub> ) (t <sub>s</sub> )	60-120 Seconds	60-120 Seconds
Average ramp up rate T <sub>smax</sub> to T <sub>p</sub>	3°C/ Second Max.	3°C/ Second Max.
Liquidous temperature (T <sub>L</sub> )	183°C	217°C
Time at liquidous (t <sub>L</sub> )	60-150 Seconds	60-150 Seconds
Peak package body temperature (T <sub>p</sub> )*	Table 1	Table 2
Time (t <sub>p</sub> )** within 5 °C of the specified classification temperature (T <sub>c</sub> )	20 Seconds**	30 Seconds**
Average ramp-down rate (T <sub>p</sub> to T <sub>smax</sub> )	6°C/ Second Max.	6°C/ Second Max.
Time 25°C to Peak Temperature	6 Minutes Max.	8 Minutes Max.

\* Tolerance for peak profile temperature (T<sub>p</sub>) is defined as a supplier minimum and a user maximum.

\*\* Tolerance for time at peak profile temperature (t<sub>p</sub>) is defined as a supplier minimum and a user maximum.

**North America**

Eaton's Electrical Group  
Electronics Division  
1225 Broken Sound Parkway NW  
Suite F  
Boca Raton, FL 33487-3533  
Tel: 1-561-998-4100  
Fax: 1-561-241-6640  
Toll Free: 1-888-414-2645

Eaton's Electrical Group  
Electronics Division  
P.O. Box 14460  
St. Louis, MO 63178-4460  
Tel: 1-636-394-2877  
Fax: 1-636-527-1607

**Europe**

Eaton's Electrical Group  
Electronics Division  
Burton-on-the-Wolds  
Leicestershire, LE 12 5th UK  
Phone: +44 (0) 1509 882 600  
Fax: +44 (0) 1509 882 786

Eaton's Electrical Group  
Electronics Division  
Avda Santa Eulalia, 290  
Terrassa, Barcelona 08223 Spain  
Phone: +34-93-736-2813  
Fax: +34-93-783-5055

**Asia Pacific**

Eaton's Electrical Group  
Electronics Division  
No.2, #06-01  
Serangoon North Avenue 5  
Singapore 554911  
Tel: +65 6645 9888  
Fax: +65 6728 3155

The only controlled copy of this Data Sheet is the electronic read-only version located on the Bussmann Network Drive. All other copies of this document are by definition uncontrolled. This bulletin is intended to clearly present comprehensive product data and provide technical information that will help the end user with design applications. Bussmann reserves the right, without notice, to change design or construction of any products and to discontinue or limit distribution of any products. Bussmann also reserves the right to change or update, without notice, any technical information contained in this bulletin. Once a product has been selected, it should be tested by the user in all possible applications.

Life Support Policy: Bussmann does not authorize the use of any of its products for use in life support devices or systems without the express written approval of an officer of the Company. Life support systems are devices which support or sustain life, and whose failure to perform, when properly used in accordance with instructions for use provided in the labeling, can be reasonably expected to result in significant injury to the user.

**Eaton's Electrical Group  
Electronics Division**  
114 Old State Road  
Ellisville, MO 63021  
United States  
www.eaton.com/elx

© 2014 Eaton  
All Rights Reserved  
Publication No. 4319 — BU-SB14110  
January 2014

Eaton is a registered trademark.

All other trademarks are property of their respective owners.



Powering Business Worldwide

www.eaton.com/elx