

FDS6986AS

Dual Notebook Power Supply N-Channel PowerTrench® SyncFET™ General Description

The FDS6986AS is designed to replace two single SO-8 MOSFETs and Schottky diode in synchronous DC:DC power supplies that provide various peripheral voltages for notebook computers and other battery powered electronic devices. FDS6986AS contains two unique 30V, N-channel, logic level, PowerTrench MOSFETs designed to maximize power conversion efficiency.

The high-side switch (Q1) is designed with specific emphasis on reducing switching losses while the low-side switch (Q2) is optimized to reduce conduction losses. Q2 also includes an integrated Schottky diode using Fairchild's monolithic SyncFET technology.

Features

- Q2:** Optimized to minimize conduction losses
Includes SyncFET Schottky body diode
7.9A, 30V $R_{DS(on)} = 20\text{ m}\Omega @ V_{GS} = 10\text{V}$
 $R_{DS(on)} = 28\text{ m}\Omega @ V_{GS} = 4.5\text{V}$
- Q1:** Optimized for low switching losses
Low gate charge (10 nC typical)
6.5A, 30V $R_{DS(on)} = 29\text{ m}\Omega @ V_{GS} = 10\text{V}$
 $R_{DS(on)} = 38\text{ m}\Omega @ V_{GS} = 4.5\text{V}$

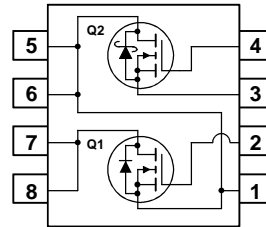
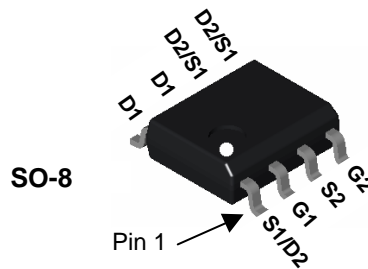

Absolute Maximum Ratings $T_A = 25^\circ\text{C}$ unless otherwise noted

| Symbol | Parameter | Q2 | Q1 | Units |
|----------------|--|-------------|----------|------------------|
| V_{DSS} | Drain-Source Voltage | 30 | 30 | V |
| V_{GSS} | Gate-Source Voltage | ± 20 | ± 16 | V |
| I_D | Drain Current - Continuous (Note 1a) | 7.9 | 6.5 | A |
| | - Pulsed | 30 | 20 | |
| P_D | Power Dissipation for Dual Operation | 2 | | W |
| | Power Dissipation for Single Operation (Note 1a) | 1.6 | | |
| | (Note 1b) | 1 | | |
| | (Note 1c) | 0.9 | | |
| T_J, T_{STG} | Operating and Storage Junction Temperature Range | -55 to +150 | | $^\circ\text{C}$ |

Thermal Characteristics

| | | | |
|-----------------|---|----|--------------------|
| $R_{\theta JA}$ | Thermal Resistance, Junction-to-Ambient (Note 1a) | 78 | $^\circ\text{C/W}$ |
| $R_{\theta JC}$ | Thermal Resistance, Junction-to-Case (Note 1) | 40 | $^\circ\text{C/W}$ |

Package Marking and Ordering Information

| Device Marking | Device | Reel Size | Tape width | Quantity |
|----------------|-----------------------|-----------|------------|------------|
| FDS6986AS | FDS6986AS | 13" | 12mm | 2500 units |
| FDS6986AS | FDS6986AS_NL (Note 4) | 13" | 12mm | 2500 units |

Electrical Characteristics $T_A = 25^\circ\text{C}$ unless otherwise noted

| Symbol | Parameter | Test Conditions | Type | Min | Typ | Max | Units |
|--------------------------------------|---|---|----------|----------|----------|-----------|----------------------|
| Off Characteristics | | | | | | | |
| BV_{DSS} | Drain-Source Breakdown Voltage | $V_{GS} = 0\text{ V}, I_D = 1\text{ mA}$ $V_{GS} = 0\text{ V}, I_D = 250\text{ }\mu\text{A}$ | Q2 Q1 | 30 30 | | | V |
| $\frac{\Delta BV_{DSS}}{\Delta T_J}$ | Breakdown Voltage Temperature Coefficient | $I_D = 1\text{ mA}$, Referenced to 25°C $I_D = 250\text{ }\mu\text{A}$, Referenced to 25°C | Q2 Q1 | | 31 23 | | mV/ $^\circ\text{C}$ |
| I_{DSS} | Zero Gate Voltage Drain Current | $V_{DS} = 24\text{ V}, V_{GS} = 0\text{ V}$ | Q2 Q1 | | | 500 1 | μA |
| I_{GSS} | Gate-Body Leakage | $V_{GS} = \pm 20\text{ V}, V_{DS} = 0\text{ V}$ $V_{GS} = \pm 16\text{ V}, V_{DS} = 0\text{ V}$ | Q2 Q1 | | | ± 100 | nA |

On Characteristics (Note 2)

| | | | | | | | |
|--|--|--|--------------|----------|----------------------------------|----------------------------------|----------------------|
| $V_{GS(th)}$ | Gate Threshold Voltage | $V_{DS} = V_{GS}, I_D = 1\text{ mA}$ $V_{DS} = V_{GS}, I_D = 250\text{ }\mu\text{A}$ | Q2 Q1 | 1 1 | 1.7 1.9 | 3 3 | V |
| $\frac{\Delta V_{GS(th)}}{\Delta T_J}$ | Gate Threshold Voltage Temperature Coefficient | $I_D = 1\text{ mA}$, Referenced to 25°C $I_D = 250\text{ }\mu\text{A}$, Referenced to 25°C | Q2 Q1 | | -3.2 -4.0 | | mV/ $^\circ\text{C}$ |
| $R_{DS(on)}$ | Static Drain-Source On-Resistance | $V_{GS} = 10\text{ V}, I_D = 7.9\text{ A}$ $V_{GS} = 10\text{ V}, I_D = 7.9\text{ A}, T_J = 125^\circ\text{C}$ $V_{GS} = 4.5\text{ V}, I_D = 7\text{ A}$ $V_{GS} = 10\text{ V}, I_D = 6.5\text{ A}$ $V_{GS} = 10\text{ V}, I_D = 6.5\text{ A}, T_J = 125^\circ\text{C}$ $V_{GS} = 4.5\text{ V}, I_D = 5.6\text{ A}$ | Q2 Q1 | | 17 25 22 21 32 32 | 20 32 28 29 49 38 | m Ω |
| $I_{D(on)}$ | On-State Drain Current | $V_{GS} = 10\text{ V}, V_{DS} = 5\text{ V}$ | Q2 Q1 | 30 20 | | | A |
| g_{FS} | Forward Transconductance | $V_{DS} = 5\text{ V}, I_D = 7.9\text{ A}$ $V_{DS} = 5\text{ V}, I_D = 6.5\text{ A}$ | Q2 Q1 | | 25 15 | | S |

Dynamic Characteristics

| | | | | | | | |
|------------|------------------------------|--|----------|--|------------|--|----------|
| C_{iss} | Input Capacitance | $V_{DS} = 10\text{ V}, V_{GS} = 0\text{ V},$ $f = 1.0\text{ MHz}$ | Q2 Q1 | | 550 720 | | pF |
| C_{oss} | Output Capacitance | | Q2 Q1 | | 180 120 | | pF |
| C_{riss} | Reverse Transfer Capacitance | | Q2 Q1 | | 70 60 | | pF |
| R_G | Gate Resistance | | Q2 Q1 | | 3.2 1.2 | | Ω |

Switching Characteristics (Note 2)

| | | | | | | | |
|--------------|---------------------|---|----------|--|----------|----------|----|
| $t_{d(on)}$ | Turn-On Delay Time | $V_{DD} = 15\text{ V}, I_D = 1\text{ A},$ $V_{GS} = 10\text{ V}, R_{GEN} = 6\text{ }\Omega$ | Q2 Q1 | | 9 10 | 18 19 | ns |
| t_r | Turn-On Rise Time | | Q2 Q1 | | 6 4 | 12 8 | ns |
| $t_{d(off)}$ | Turn-Off Delay Time | | Q2 Q1 | | 25 24 | 40 39 | ns |
| t_f | Turn-Off Fall Time | | Q2 Q1 | | 4 3 | 8 6 | ns |
| $t_{d(on)}$ | Turn-On Delay Time | $V_{DD} = 15\text{ V}, I_D = 1\text{ A},$ $V_{GS} = 4.5\text{ V}, R_{GEN} = 6\text{ }\Omega$ | Q2 Q1 | | 11 10 | 20 20 | ns |
| t_r | Turn-On Rise Time | | Q2 Q1 | | 15 9 | 26 18 | ns |
| $t_{d(off)}$ | Turn-Off Delay Time | | Q2 Q1 | | 15 13 | 26 23 | ns |
| t_f | Turn-Off Fall Time | | Q2 Q1 | | 6 3 | 12 6 | ns |

Electrical Characteristics (continued)

$T_A = 25^\circ\text{C}$ unless otherwise noted

| Symbol | Parameter | Test Conditions | Type | Min | Typ | Max | Units |
|---|--|--|------|-----|-----|-----|-------|
| Switching Characteristics (Note 2) | | | | | | | |
| $Q_{g(\text{TOT})}$ | Total Gate Charge, $V_{gs} = 10\text{V}$ | $V_{DS} = 15\text{ V}, I_D = 7.9\text{ A}$ $V_{DS} = 15\text{ V}, I_D = 6.5\text{ A}$ | Q2 | | 10 | 14 | nC |
| Q_g | Total Gate Charge, $V_{gs} = 5\text{V}$ | | Q1 | | 12 | 17 | nC |
| Q_{gs} | Gate-Source Charge | | Q2 | | 5.6 | 8 | nC |
| Q_{gd} | Gate-Drain Charge | | Q1 | | 6.5 | 9 | nC |
| | | | Q2 | | 2.0 | | nC |
| | | | Q1 | | 2.3 | | nC |
| | | | Q2 | | 1.5 | | nC |
| | | | Q1 | | 2.1 | | nC |

Drain-Source Diode Characteristics and Maximum Ratings

| | | | | | | | |
|----------|---|--|----------|--|-----|------------|----|
| I_S | Maximum Continuous Drain-Source Diode Forward Current | | Q2 Q1 | | | 3.0 1.3 | A |
| T_{rr} | Reverse Recovery Time | $I_F = 10\text{ A},$ $dI_F/dt = 300\text{ A}/\mu\text{s}$ (Note 3) | Q2 | | 15 | | ns |
| Q_{rr} | Reverse Recovery Charge | | | | 6 | | nC |
| T_{rr} | Reverse Recovery Time | $I_F = 6.5\text{ A},$ $dI_F/dt = 100\text{ A}/\mu\text{s}$ (Note 3) | Q1 | | 20 | | ns |
| Q_{rr} | Reverse Recovery Charge | | | | 12 | | nC |
| V_{SD} | Drain-Source Diode Forward Voltage | $V_{GS} = 0\text{ V}, I_S = 2.3\text{ A}$ (Note 2) $V_{GS} = 0\text{ V}, I_S = 1.3\text{ A}$ (Note 2) | Q2 | | 0.6 | 0.7 | V |
| | | | Q1 | | 0.8 | 1.2 | |

Notes:

- $R_{\theta JA}$ is the sum of the junction-to-case and case-to-ambient thermal resistance where the case thermal reference is defined as the solder mounting surface of the drain pins. $R_{\theta JC}$ is guaranteed by design while $R_{\theta CA}$ is determined by the user's board design.

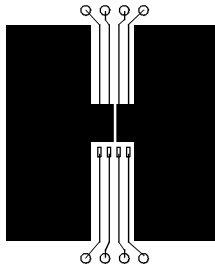

a) 78°C/W when mounted on a 0.5 in² pad of 2 oz copper

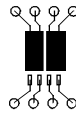

b) 125°C/W when mounted on a 0.02 in² pad of 2 oz copper

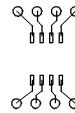

c) 135°C/W when mounted on a minimum pad.

Scale 1 : 1 on letter size paper

- Pulse Test: Pulse Width < 300 μs , Duty Cycle < 2.0%
- See "SyncFET Schottky body diode characteristics" below.
- FDS6986AS_NL is a lead free product. FDS6986AS_NL marking will appear on the reel label.

Typical Characteristics: Q2

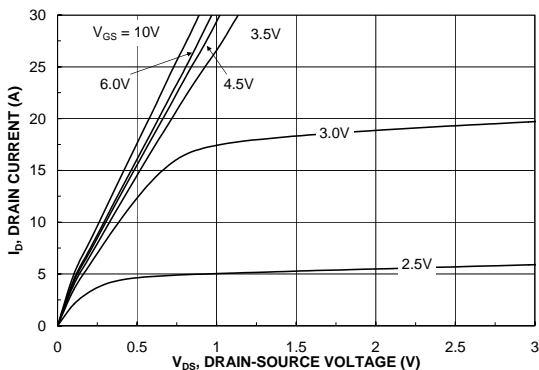

Figure 1. On-Region Characteristics.

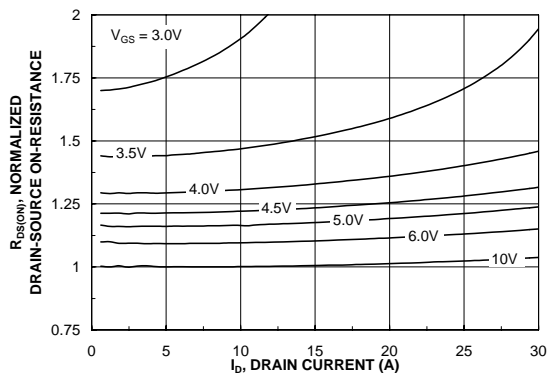

Figure 2. On-Resistance Variation with Drain Current and Gate Voltage.

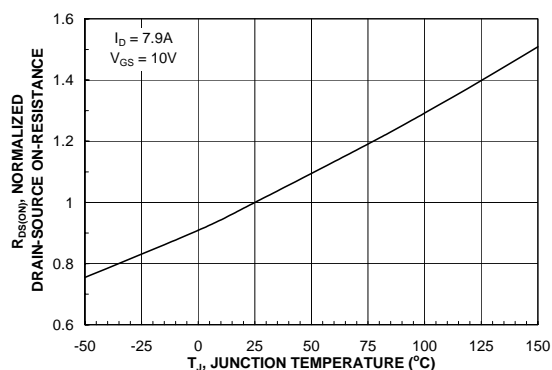

Figure 3. On-Resistance Variation with Temperature.

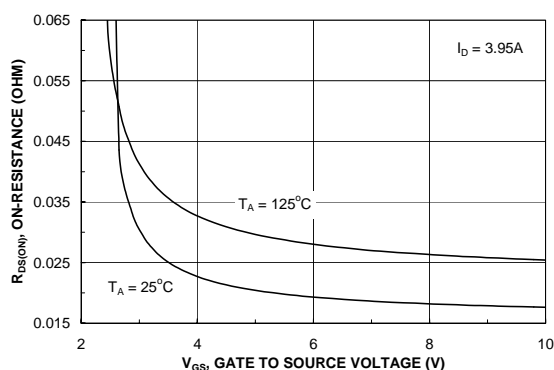

Figure 4. On-Resistance Variation with Gate-to-Source Voltage.

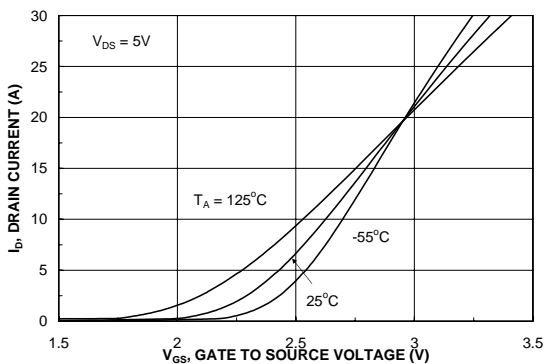

Figure 5. Transfer Characteristics.

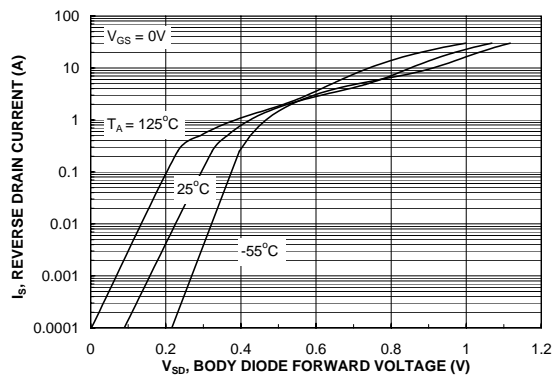

Figure 6. Body Diode Forward Voltage Variation with Source Current and Temperature.

Typical Characteristics: Q2

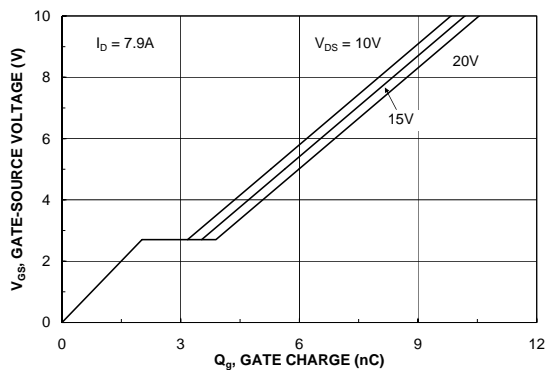

Figure 7. Gate Charge Characteristics.

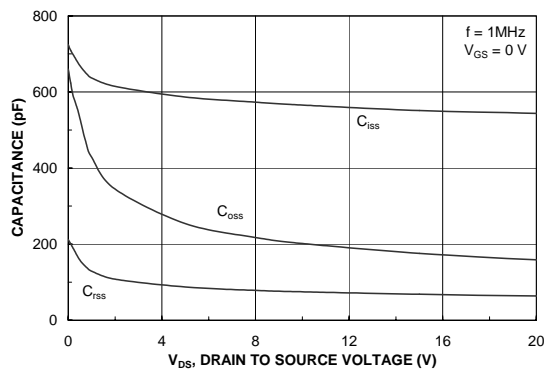

Figure 8. Capacitance Characteristics.

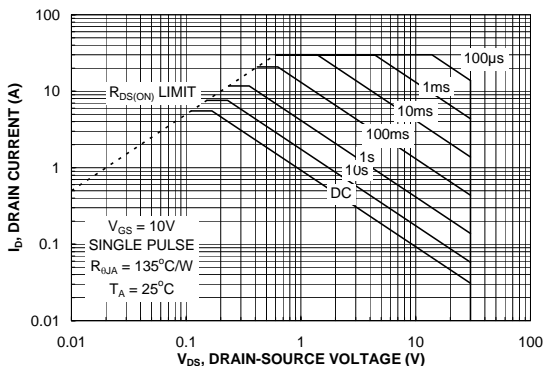

Figure 9. Maximum Safe Operating Area.

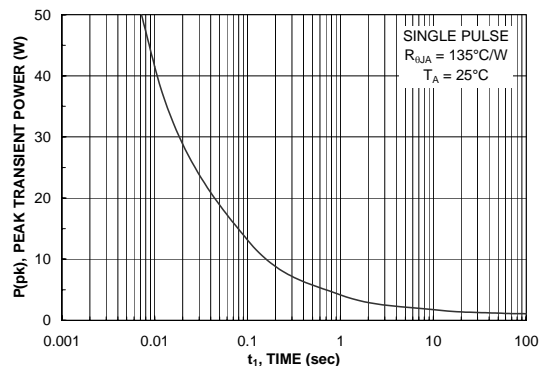

Figure 10. Single Pulse Maximum Power Dissipation.

Typical Characteristics Q1

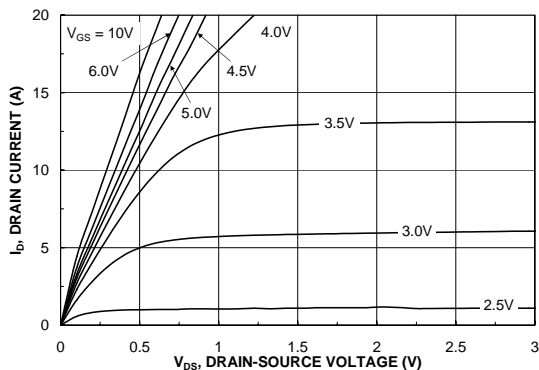

Figure 11. On-Region Characteristics.

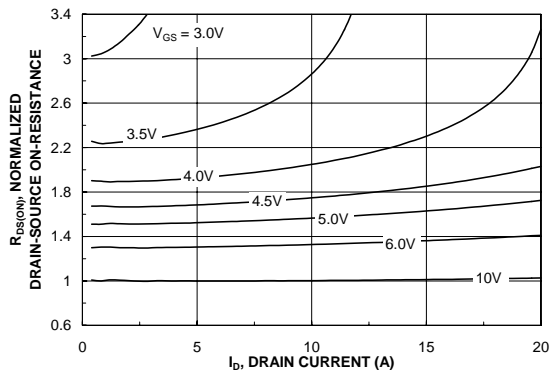

Figure 12. On-Resistance Variation with Drain Current and Gate Voltage.

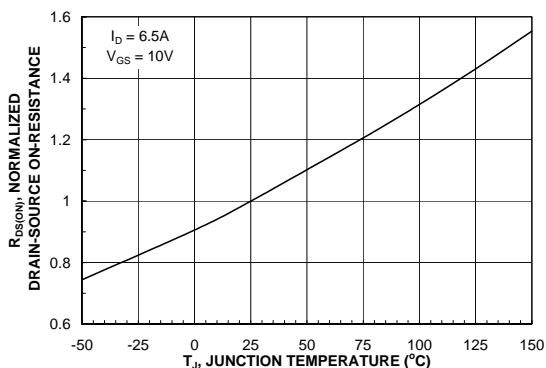

Figure 13. On-Resistance Variation with Temperature.

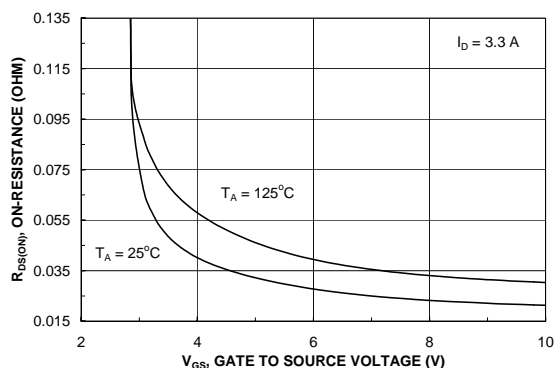

Figure 14. On-Resistance Variation with Gate-to-Source Voltage.

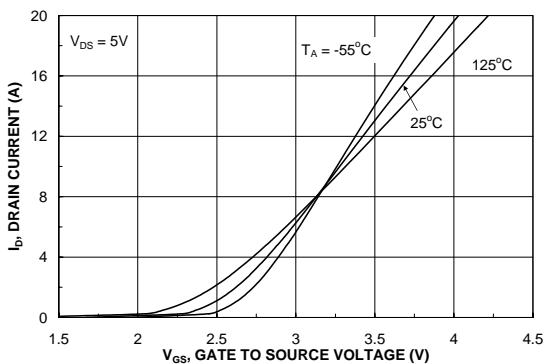

Figure 15. Transfer Characteristics.

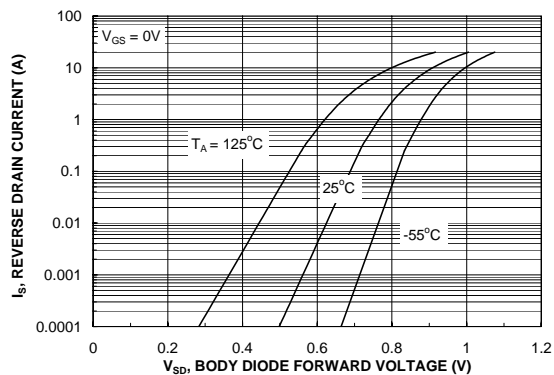

Figure 16. Body Diode Forward Voltage Variation with Source Current and Temperature.

Typical Characteristics Q1

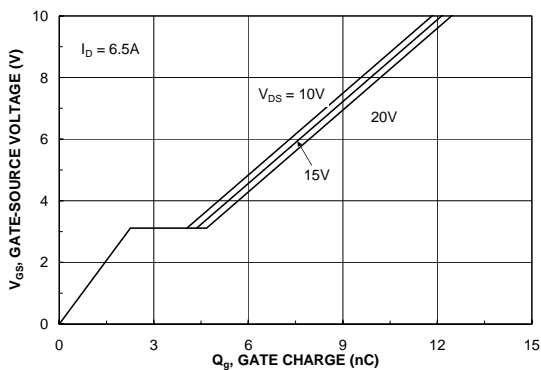

Figure 17. Gate Charge Characteristics.

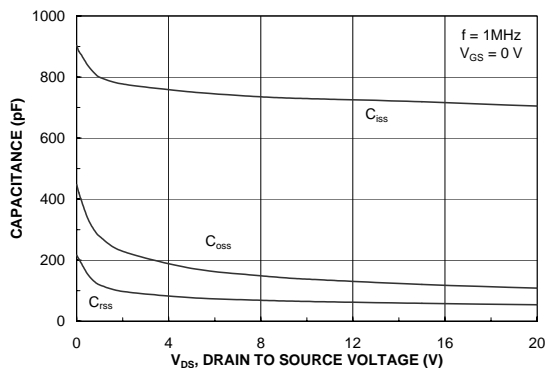

Figure 18. Capacitance Characteristics.

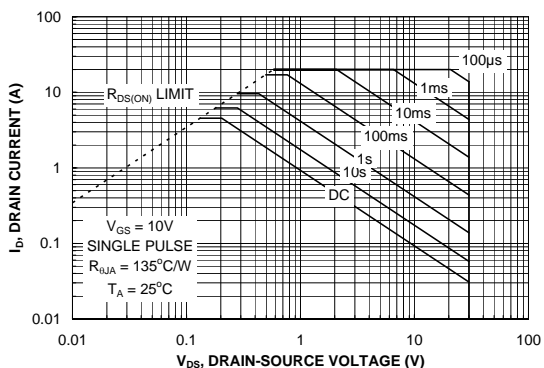

Figure 19. Maximum Safe Operating Area.

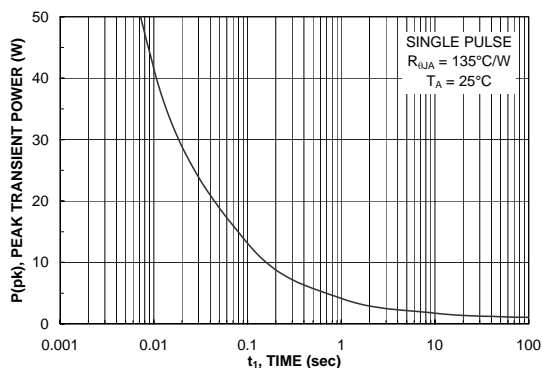

Figure 20. Single Pulse Maximum Power Dissipation.

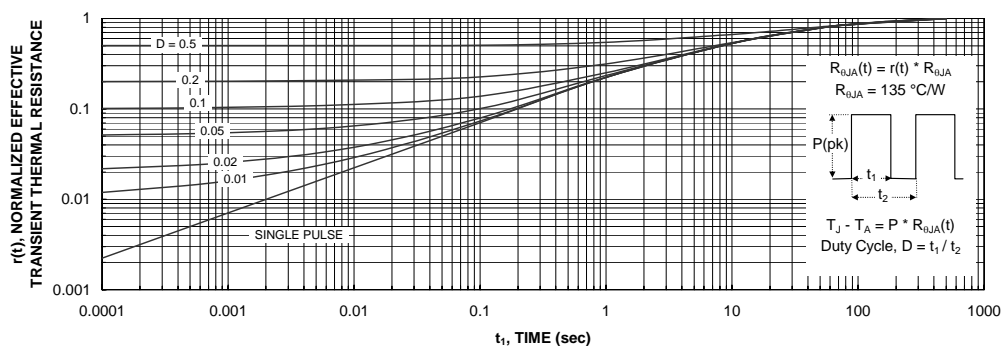

Figure 21. Transient Thermal Response Curve.

Thermal characterization performed using the conditions described in Note 1c.
Transient thermal response will change depending on the circuit board design.

Typical Characteristics (continued)

SyncFET Schottky Body Diode Characteristics

Fairchild's SyncFET process embeds a Schottky diode in parallel with PowerTrench MOSFET. This diode exhibits similar characteristics to a discrete external Schottky diode in parallel with a MOSFET. Figure 22 shows the reverse recovery characteristic of the FDS6986AS.

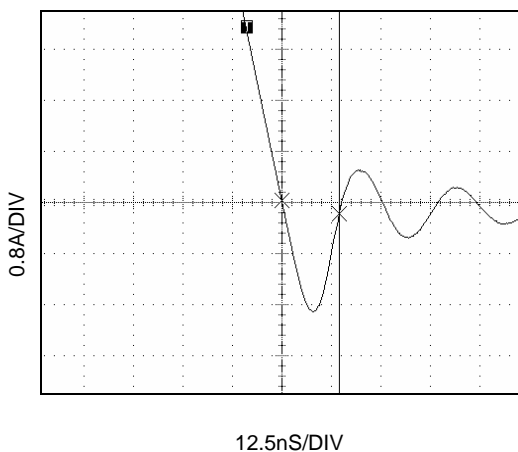

Figure 22. FDS6986AS SyncFET body diode reverse recovery characteristic.

For comparison purposes, Figure 23 shows the reverse recovery characteristics of the body diode of an equivalent size MOSFET produced without SyncFET (FDS6690A).

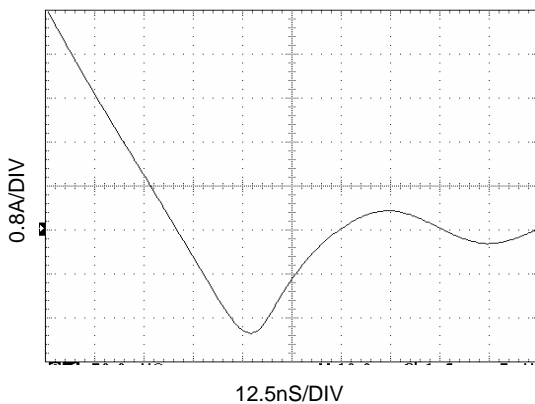

Figure 23. Non-SyncFET (FDS6690A) body diode reverse recovery characteristic.

Schottky barrier diodes exhibit significant leakage at high temperature and high reverse voltage. This will increase the power in the device.

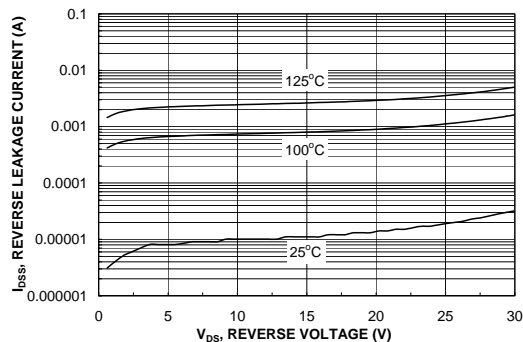

Figure 24. SyncFET body diode reverse leakage versus drain-source voltage and temperature.

Typical Characteristics

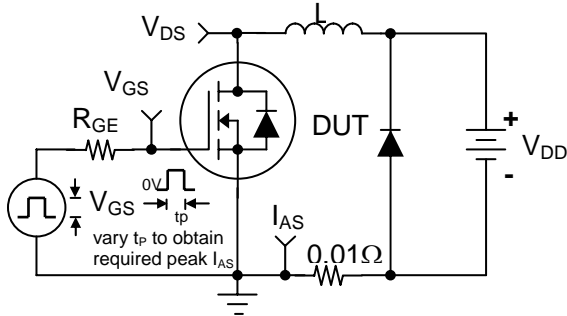

Figure 25. Unclamped Inductive Load Test Circuit

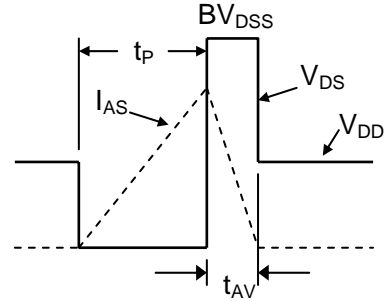

Figure 26. Unclamped Inductive Waveforms

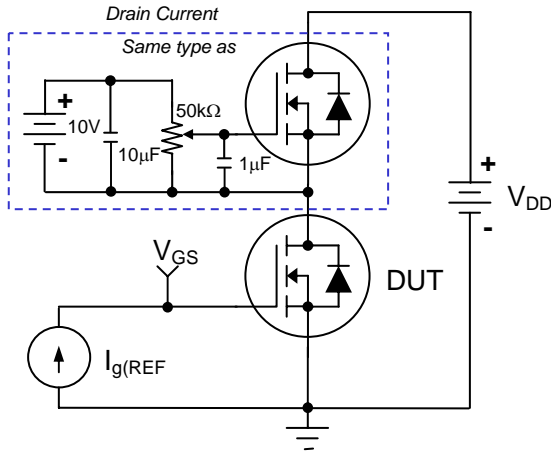

Figure 27. Gate Charge Test Circuit

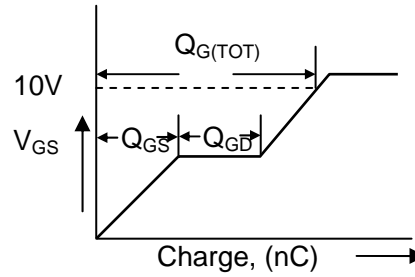

Figure 28. Gate Charge Waveform

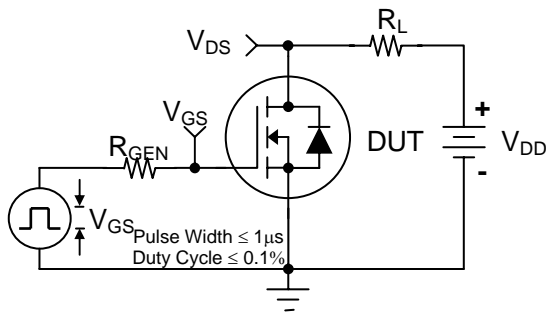

Figure 29. Switching Time Test Circuit

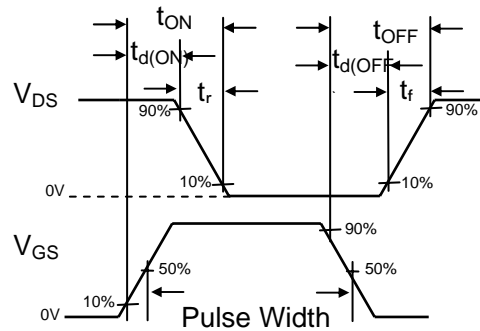

Figure 30. Switching Time Waveforms

TRADEMARKS

The following are registered and unregistered trademarks Fairchild Semiconductor owns or is authorized to use and is not intended to be an exhaustive list of all such trademarks.

| | | | | |
|--------------------------------------|---------------------|---------------|---------------------|-----------------|
| ACEx™ | FAST® | IntelliMAX™ | POP™ | SPM™ |
| ActiveArray™ | FASTr™ | ISOPLANAR™ | Power247™ | Stealth™ |
| Bottomless™ | FPST™ | LittleFET™ | PowerEdge™ | SuperFET™ |
| CoolFET™ | FRFET™ | MICROCOUPLER™ | PowerSaver™ | SuperSOT™-3 |
| CROSSVOLT™ | GlobalOptoisolator™ | MicroFET™ | PowerTrench® | SuperSOT™-6 |
| DOMET™ | GTO™ | MicroPak™ | QFET® | SuperSOT™-8 |
| EcoSPARK™ | HiSeC™ | MICROWIRE™ | QS™ | SyncFET™ |
| E ² CMOS™ | ꝑC™ | MSX™ | QT Optoelectronics™ | TinyLogic® |
| EnSigna™ | i-Lo™ | MSXPro™ | Quiet Series™ | TINYOPTO™ |
| FACT™ | ImpliedDisconnect™ | OCX™ | RapidConfigure™ | TruTranslation™ |
| FACT Quiet Series™ | | OCXPro™ | RapidConnect™ | UHC™ |
| Across the board. Around the world.™ | | OPTOLOGIC® | µSerDes™ | UltraFET® |
| The Power Franchise® | | OPTOPLANAR™ | SILENT SWITCHER® | UniFET™ |
| Programmable Active Droop™ | | PACMAN™ | SMART START™ | VCX™ |

DISCLAIMER

FAIRCHILD SEMICONDUCTOR RESERVES THE RIGHT TO MAKE CHANGES WITHOUT FURTHER NOTICE TO ANY PRODUCTS HEREIN TO IMPROVE RELIABILITY, FUNCTION OR DESIGN. FAIRCHILD DOES NOT ASSUME ANY LIABILITY ARISING OUT OF THE APPLICATION OR USE OF ANY PRODUCT OR CIRCUIT DESCRIBED HEREIN; NEITHER DOES IT CONVEY ANY LICENSE UNDER ITS PATENT RIGHTS, NOR THE RIGHTS OF OTHERS.

LIFE SUPPORT POLICY

FAIRCHILD'S PRODUCTS ARE NOT AUTHORIZED FOR USE AS CRITICAL COMPONENTS IN LIFE SUPPORT DEVICES OR SYSTEMS WITHOUT THE EXPRESS WRITTEN APPROVAL OF FAIRCHILD SEMICONDUCTOR CORPORATION. As used herein:

1. Life support devices or systems are devices or systems which, (a) are intended for surgical implant into the body, or (b) support or sustain life, or (c) whose failure to perform when properly used in accordance with instructions for use provided in the labeling, can be reasonably expected to result in significant injury to the user.
2. A critical component is any component of a life support device or system whose failure to perform can be reasonably expected to cause the failure of the life support device or system, or to affect its safety or effectiveness.

PRODUCT STATUS DEFINITIONS

Definition of Terms

| Datasheet Identification | Product Status | Definition |
|--------------------------|------------------------|---|
| Advance Information | Formative or In Design | This datasheet contains the design specifications for product development. Specifications may change in any manner without notice. |
| Preliminary | First Production | This datasheet contains preliminary data, and supplementary data will be published at a later date. Fairchild Semiconductor reserves the right to make changes at any time without notice in order to improve design. |
| No Identification Needed | Full Production | This datasheet contains final specifications. Fairchild Semiconductor reserves the right to make changes at any time without notice in order to improve design. |
| Obsolete | Not In Production | This datasheet contains specifications on a product that has been discontinued by Fairchild semiconductor. The datasheet is printed for reference information only. |