



HOLLYLAND®
高新技术企业
High Technology Enterprise

HOLLY®

电力系统过流保护 RoHS&Pb-Free
Power System Overcurrent Protection

好利® 熔断器

Your Power Safeguard™
您的电路安全卫士



好利来(中国)电子科技股份有限公司
Hollyland (China) Electronics Technology Corporation Limited

股票代码/Stock Code:002729



2015-2016

公司荣誉

Honors and Awards

中国电器工业协会电器附件及家用控制器分会第六届理事会常务理事单位

Member of the 6th Council of Electrical Accessories & Automatic controls Institute of China Electrical Equipment Industrial Association Branch

全国熔断器标准化技术委员会成员

Member of the National Technical Committee on Fuses of Standardization Administration of China

厦门市高新技术发展协会理事会副会长单位

Vice-President Unit of Xiamen High-tech Development Association

福建名牌产品

The Famous-brand Product of Fujian Province

福建省及厦门市著名商标

The Famous Trademark of Fujian Province and Xiamen City

厦门市出口名牌企业

The famous Exporting Brand of Xiamen City

厦门市自主创新试点企业

An Experimental Enterprise in Innovation of Xiamen City

“感动人的管理”企业

An Enterprise with Touching Management

全国熔断器标准化技术委员会小型熔断器分技术委员会成员

Member of the Subcommittee on Miniature Fuse of National Technical Committee on Fuses of Standardization Administration of China

厦门电子元器件产业技术创新战略联盟理事长单位

President Organization of Xiamen Electronic Components Technology Innovation Strategic Alliance

福建省创新型试点企业

An Experimental Enterprise in Innovation of Fujian Province

厦门市高新技术企业

A High Technology Enterprise of Xiamen City

厦门市守合同重信用企业

An Enterprise with Good Sincerity & Credit

厦门市创新型示范企业

A Model Enterprise in Innovation of Xiamen City

资信等级为AAA-级企业

An Enterprise with AAA- Credit Rating

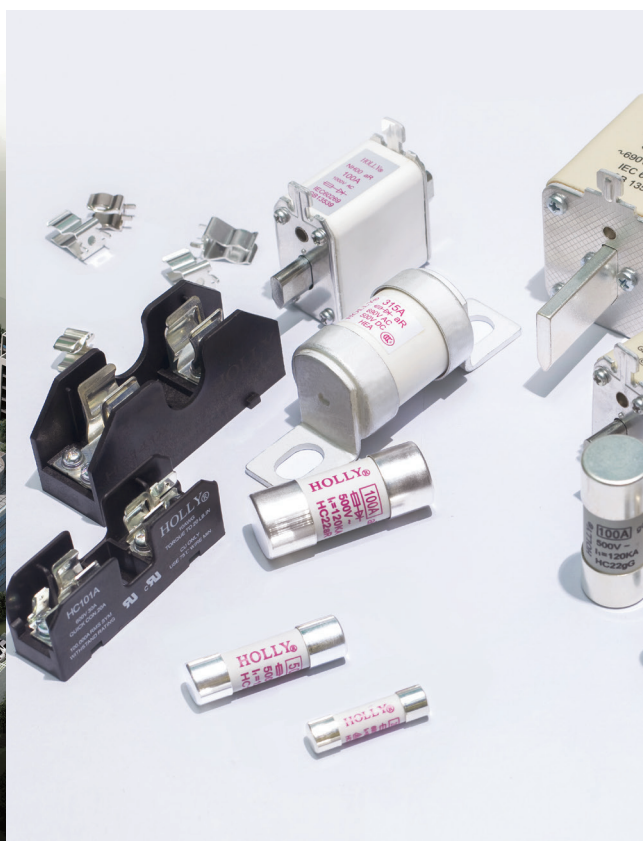

公司简介

Company Introduction

好利来（中国）电子科技股份有限公司秉承“以人为本、责任与分享”的经营理念，拥有20多年的电路保护器设计、制造经验。公司研发生产的低压熔断器系列产品设计严谨、精选用材，设计过程均经过第三方专业测试机构严格的试验验证，产品性能指标优，品质稳定，已广泛应用于石油、化工、工业机械、冶金、建筑、通讯、电力、轨道交通和电动汽车等领域，用于电力系统输配电电缆及相关设备器件的保护。产品达到国际先进水平，部分产品领先国际同行，通过了CCC、CGC、VDE、UL、cUL、cURus、TUV等安全认证。

公司获得了BSI ISO9001、ISO/TS16949品质体系认证和CQC ISO14001环境体系认证。公司拥有先进的生产系统，并严格执行PPM品质保证及TQM全面品质管理。强大的研发、生产工程及品质控制专业团队确保“好利来®”产品的卓越品质、完全符合RoHS指令、REACH法规及实现无铅化生产。

与大家分享安全环保的环境是我们义不容辞的责任。

Hollyland (China) Electronics Technology Corporation Limited upholds the belief of “people-oriented, accountability and sharing” as the business philosophy.

With more than 20 years of circuit protection devices design and manufacturing experiences, the company persists with careful and stringent design, well-chosen raw material, and strict experiment validation by the third-party testing body to assure the excellent performance and reliable quality. With such effort, it has developed a series of low voltage fuses which are widely used in petroleum, chemical industry, industrial machinery, metallurgy, architecture, communication, electronic power system, rail transit, electric vehicle, and other fields, in order to protect power transmission and distribution cable and related equipments and devices in the above power system. The product reaches high international standards, and has passed CCC, CGC, VDE, UL, cUL, cURus, TUV and other safety certifications, furthermore, some of the product has a good lead over our international competitor's.

The company has acquired BSI ISO9001, ISO/TS16949 quality system certification and CQC ISO14001 environmental system certifications. The company also has advanced production systems, strict implementation of PPM quality assurance and total quality management TQM. At the same time, it has strong R&D, production and quality control teams, ensuring the excellent quality of the “HOLLY®” products, as well as its full compliance with RoHS Directive, REACH regulations and the implementation of the lead - free production.

Hollyland (China) Electronics Technology Corporation Limited is committed to safe and environmental friendly surroundings.



公司宗旨

Company's Mission

为客户创造价值 为员工提供平台

Create value for customers and provide workplace for employees

为企业创造利润 为股东增加回报

Generate profits for the enterprises and for its shareholders

用信誉赢得尊重 用责任回报社会

Earn respect with creditability and give back to the society with social responsibility

Index 产品索引

	TYPE	DESCRIPTION	RATING	APPROVALS	
Cylindrical fuse	HC10gPV	Photovoltaic fuse	1A-20A, 1000V	CGC, TUV	P01
	HC10PV	Photovoltaic fuse	1A-20A, 1000V	UL	P02
	HC10LgPV	Photovoltaic fuse	1A-30A, 1000V / 1500V		P03
	HC14gPV	Photovoltaic fuse	10A-15A, 1500V		P04
	HC14LgPV	Photovoltaic fuse	10A-32A, 1500V		P05
	HC10aR	aR Type	250mA-32A, 500V / 690V / 1000V	CCC, cURus, VDE	P06
	HC10aR-C	aR Type	250mA-32A, 500V / 690V / 1000V		P07
	HC10gG	gG Type	500mA-32A, 400V / 500V / 690V	CCC	P08
	HC10aM	aM Type	500mA-32A, 400V / 500V	CCC	P09
	HC10N	Fast-Acting Type	1A-30A, 600V	UL, cUL	P10
	HC10S	Time-Delay Type	500mA-30A, 500V	UL, cUL	P11
	HC10NR	Fast-Acting Type	1A-30A, 300V DC / 600V AC	UL, cUL	P12
	HC10SR	Time-Delay Type	1A-30A, 300V / 600V	UL, cUL	P13
	HC14gG	gG Type	2A-50A, 500V / 690V	CCC	P14
	HC08aR	aR Type	500mA-25A, 400V		P15
	HC14aR	aR Type	4A-50A, 500V / 690V		P15
	HC22aR	aR Type	4A-100A, 500V / 690V		P15
	HC08gG	gG Type	500mA-25A, 400V		P16
	HC22gG	gG Type	4A-125A 500V / 690V		P16
	HC08aM	aM Type	1A-10A 400V		P17
HC14aM	aM Type	2A-50A, 400V / 500V / 690V		P17	
HC22aM	aM Type	4A-125A, 500V / 690V		P17	
Semiconduc tor fuse	HBC	aR Type	35A-1200A, 500V		P18
	HBD	aR Type	35A-600A, 700V		P19
	HBE	aR Type	35A-800A, 750V / 1000V		P20
	HEA	aR Type	6A-400A, 500V / 690V	CCC, cuRus	P21
	H3BD	aR Type	500A-1800A, 600V / 690V / 700V		P22
	H3BE	aR Type	315A-1250A, 1000V		P23
	H3BF	aR Type	315A-1100A, 1250V / 1300V		P24
	H3FD	aR Type	500A-1800A, 600V / 690V / 700V		P25
	H3FE	aR Type	315A-1250A, 1000V		P26
	H3FF	aR Type	315A-1100A, 1250V / 1300V		P27
NH fuse	NH1gPV	Photovoltaic fuse	40A-250A, 1100V	CGC, TUV	P28
	NH1XLgPV	Photovoltaic fuse	80A-250A, 1000V		P29
	NH2XLgPV	Photovoltaic fuse	125A-400A, 1100V	CGC, TUV	P30
	NH3LgPV	Photovoltaic fuse	315A-630A, 1100V		P31
	NH1XLgPV	Photovoltaic fuse	63A-200A, 1500V		P32
	NH2XLgPV	Photovoltaic fuse	125A-400A, 1500V		P33
	NH00gG	gG Type	2A-100A, 500V	CCC	P34
	NH00gG	gG Type	10A-160A, 500V / 690V	CCC	P35
	NH1gG	gG Type	6A-250A, 500V		P36
	NH2gG	gG Type	20A-400A, 500V		P37
	NH3gG	gG Type	63A-630A, 500V		P38
	NHgG	gG Type	2A-630A, 400V		P39
	NHgG	gG Type	2A-500A, 690V		P40
	NHaM	aM Type	2A-630A, 500V		P41
	NHaM	aM Type	2A-630A, 690V		P42
Fuse holder, clip & block					P43-46
Microswitch					P47



HC10gPV 1A-20A Photovoltaic Fuse 光伏熔断器

Standard/ 标准: IEC 60269-6, GB/T 13539.6



INTERRUPTING CAPACITY / 分断能力:

30,000 amperes at 1000V DC (Time Constant/ 时间常数: 1-3ms)

Dimensions/ 尺寸:

Unit 单位: mm

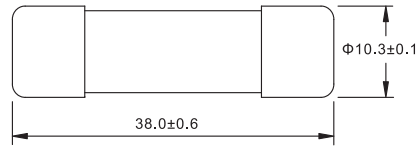

TECHNICAL PARAMETERS/ 技术参数:

CATALOG NO. 目录编号	CURRENT RATING 额定电流	SAFETY APPROVALS 安全认证	
		CGC	TUV
10gPV1U0	1A	●	●
10gPV2U0	2A	●	●
10gPV3U0	3A	●	●
10gPV3.5U0	3.5A	●	●
10gPV4U0	4A	●	●
10gPV5U0	5A	●	●
10gPV6U0	6A	●	●
10gPV8U0	8A	●	●
10gPV10U0	10A	●	●
10gPV12U0	12A	●	●
10gPV15U0	15A	●	●
10gPV16U0	16A	●	●
10gPV20U0	20A	●	●

U0 DENOTES FOR 1000V DC
● DENOTES FOR APPROVAL
○ DENOTES FOR PENDING

U0 表示 1000V DC
● 表示已取得安全认证
○ 表示正在申请安全认证

ELECTRICAL CHARACTERISTICS/ 电气特性:

% of CURRENT RATING 额定电流的 %	BLOWING TIME 熔断时间
113%	1 hour Min. 最快 1 小时
145%	1 hour Max. 最慢 1 小时

HC10gPV 平均 I-T 曲线图 (仅供参考)

AVERAGE I-T CHARACTERISTICS CURVE
(FOR REFERENCE ONLY)

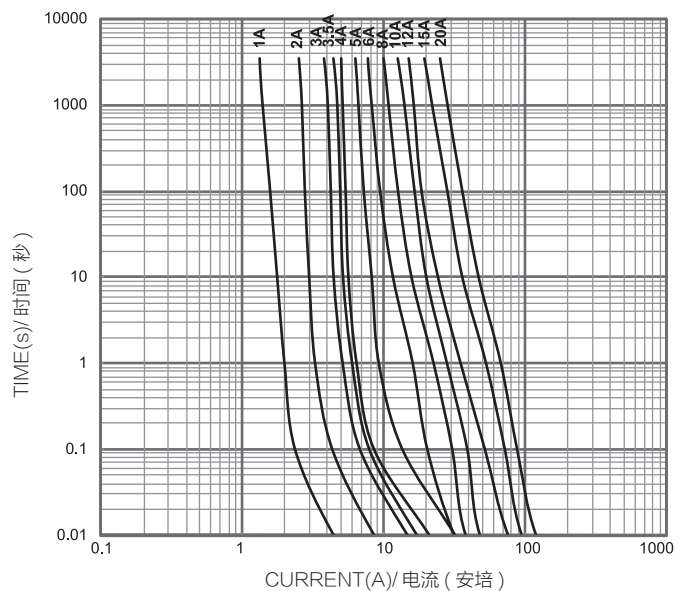

Recommended fuse-base for 10.3mmx38mm fuses

See Model of product: HC101D HF-103D HF-104A

适用于 10.3mmx38mm 熔断体的支持件

详见产品型号: HC101D HF-103D HF-104A





Your Power Safeguard™
您的电路安全卫士



HC10PV 1A-20A Photovoltaic Fuse 光伏熔断器

Standard/ 标准: UL 2579



INTERRUPTING CAPACITY / 分断能力:

30,000 amperes at 1000V DC

(Time Constant / 时间常数: 1ms or less)

Dimensions/ 尺寸:

Unit 单位: mm

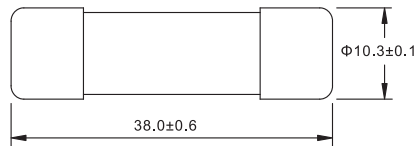

TECHNICAL PARAMETERS/ 技术参数:

CATALOG NO. 目录编号	CURRENT RATING 额定电流	SAFETY APPROVALS 安全认证
		UL
10PV1U0	1A	●
10PV2U0	2A	●
10PV3U0	3A	●
10PV3.5U0	3.5A	●
10PV4U0	4A	●
10PV5U0	5A	●
10PV6U0	6A	●
10PV8U0	8A	●
10PV10U0	10A	●
10PV12U0	12A	●
10PV15U0	15A	●
10PV16U0	16A	●
10PV20U0	20A	●

U0 DENOTES FOR 1000V DC

● DENOTES FOR APPROVAL

○ DENOTES FOR PENDING

U0 表示 1000V DC

● 表示已取得安全认证

○ 表示正在申请安全认证

ELECTRICAL CHARACTERISTICS/ 电气特性:

% of CURRENT RATING 额定电流的 %	BLOWING TIME 熔断时间	
100%	4 hours Min.	最快 4 小时
135%	1 hour Max.	最慢 1 小时
200%	240 seconds Max.	最慢 240 秒

HC10PV 平均 I-T 曲线图 (仅供参考)

AVERAGE I-T CHARACTERISTICS CURVE
(FOR REFERENCE ONLY)

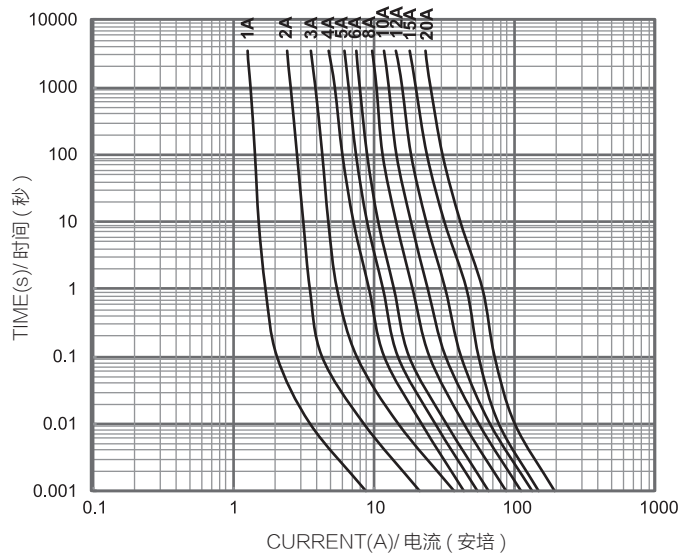

Recommended fuse-base for 10.3mmx38mm fuses

See Model of product: HC101D HF-103D HF-104A

适用于 10.3mmx38mm 熔断体的支持件

详见产品型号: HC101D HF-103D HF-104A





HC10LgPV 1A-30A Photovoltaic Fuse 光伏熔断器

Standard/ 标准: IEC 60269-6, GB/T 13539.6

INTERRUPTING CAPACITY (Time Constant:1-3ms)/ 分断能力 (时间常数: 1-3ms):

20,000 amperes at 1500V DC (1A-20A)
20,000 amperes at 1000V DC (25A-30A)

Dimensions/ 尺寸:

Unit 单位: mm

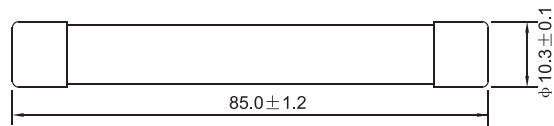

TECHNICAL PARAMETERS/ 技术参数:

CATALOG NO. 目录编号	CURRENT RATING 额定电流	SAFETY APPROVALS 安全认证	
		CQC	TUV
10LgPV1U15	1A	○	○
10LgPV2U15	2A	○	○
10LgPV3U15	3A	○	○
10LgPV4U15	4A	○	○
10LgPV5U15	5A	○	○
10LgPV6U15	6A	○	○
10LgPV8U15	8A	○	○
10LgPV10U15	10A	○	○
10LgPV12U15	12A	○	○
10LgPV15U15	15A	○	○
10LgPV16U15	16A	○	○
10LgPV20U15	20A	○	○
10LgPV25U0	25A	○	○
10LgPV30U0	30A	○	○

U15 DENOTES FOR 1500V DC
U0 DENOTES FOR 1000V DC
● DENOTES FOR APPROVAL
○ DENOTES FOR PENDING

U15 表示 1500V DC
U0 表示 1000V DC
● 表示已取得安全认证
○ 表示正在申请安全认证

ELECTRICAL CHARACTERISTICS/ 电气特性:

% of CURRENT RATING 额定电流的 %	BLOWING TIME 熔断时间
113%	1 hour Min. 最快 1 小时
145%	1 hour Max. 最慢 1 小时

HC10LgPV 平均 I-T 曲线图 (仅供参考)

AVERAGE I-T CHARACTERISTICS CURVE
(FOR REFERENCE ONLY)

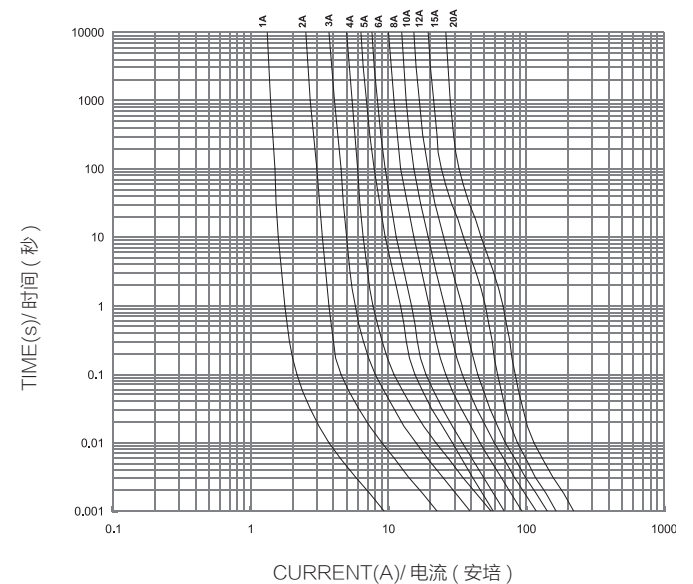

Recommended fuse-base for 10mmx85mm fuses

See Model of product: HF-103D HF-104A

适用于 10mmx85mm 熔断体的支持件

详见产品型号: HF-103D HF-104A

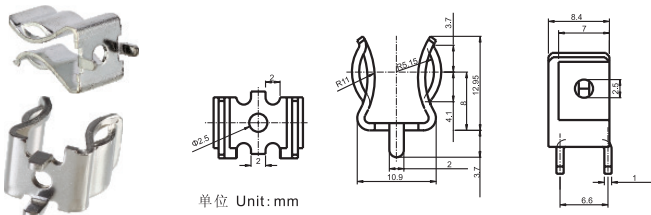

单位 Unit: mm



HC14gPV 1500V DC 10A-15A Photovoltaic Fuse 光伏熔断器

Standard/ 标准: IEC 6026-6 GB/T 13539.6

INTERRUPTING CAPACITY / 分断能力:
30,000 amperes at 1500V DC (Time Constant:1-3ms)

Dimensions/ 尺寸:

Unit 单位: mm

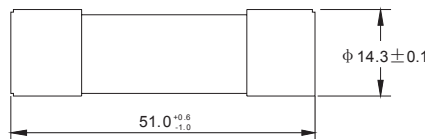

TECHNICAL PARAMETERS/ 技术参数:

CATALOG NO. 目录编号	CURRENT RATING 额定电流	SAFETY APPROVALS 安全认证	
		TUV	CGC
14gPV10U15	10A	○	○
14gPV12U15	12A	○	○
14gPV15U15	15A	○	○

U15 DENOTES FOR 1500V DC U15 表示 1500V DC
● DENOTES FOR APPROVAL ● 表示已取得安全认证
○ DENOTES FOR PENDING ○ 表示正在申请安全认证

ELECTRICAL CHARACTERISTICS/ 电气特性:

% of CURRENT RATING 额定电流的 %	BLOWING TIME 熔断时间
113%	1 hour Min. 最快 1 小时
145%	1 hour Max. 最慢 1 小时

Recommended fuse-base for 14.3mmx51mm fuses

See Model of product: HC141B HF-141A

适用于 14.3mmx51mm 熔断体的支持件

详见产品型号: HC141B HF-141A

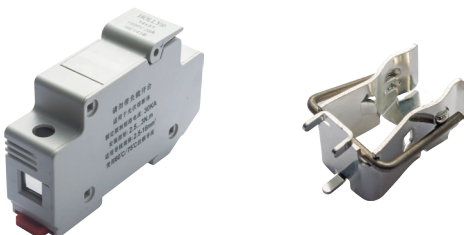

HC14gPV 1500V 平均 I-T 曲线图 (仅供参考)

AVERAGE I-T CHARACTERISTICS CURVE
(FOR REFERENCE ONLY)

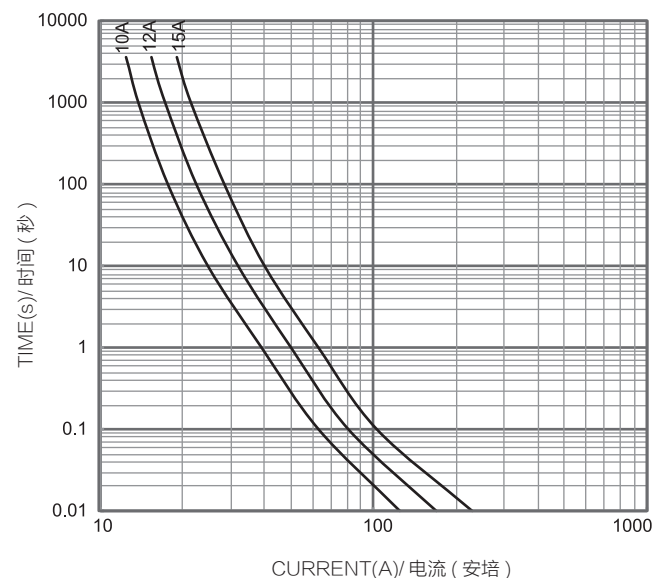

HC14LgPV DC 10A-32A Photovoltaic Fuse 光伏熔断器



Standard/ 标准: UL2579

INTERRUPTING CAPACITY / 分断能力:

30,000 amperes at 1500V DC (10~20A Time Constant:<1ms)
30,000 amperes at 1300V DC (25~32A Time Constant:<1ms)

Dimensions/ 尺寸:

Unit 单位: mm

Type:HC14LgPV Part No.: 14LgPV(amp rating)U15

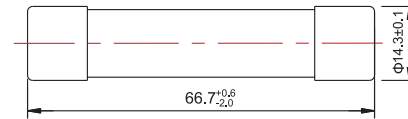

Part No.: 14LgPV(amp rating)U15-T

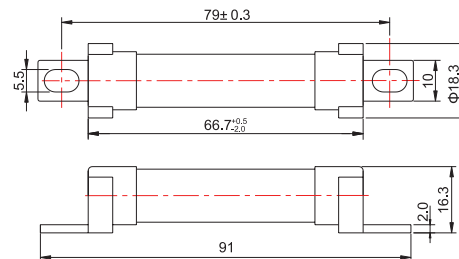

TECHNICAL PARAMETERS/ 技术参数:

CATALOG NO. 目录编号	CURRENT RATING 额定电流	SAFETY APPROVALS 安全认证
14LgPV10U15	10A	○
14LgPV10U15-T		○
14LgPV12U15	12A	○
14LgPV12U15-T		○
14LgPV15U15	15A	○
14LgPV15U15-T		○
14LgPV20U15	20A	○
14LgPV20U15-T		○
14LgPV25U13	25A	○
14LgPV25U13-T		○
14LgPV32U13	32A	○
14LgPV32U13-T		○

U15 DENOTES FOR 1500V DC U15 表示 1500V DC
U13 DENOTES FOR 1300V DC U13 表示 1300V DC
● DENOTES FOR APPROVAL ● 表示已取得安全认证
○ DENOTES FOR PENDING ○ 表示正在申请安全认证

Recommended fuse-base for 14.3mmx65mm fuses
See Model of product: HF-141A

适用于 14.3mmx65mm 熔断体的支持件
详见产品型号: HF-141A



ELECTRICAL CHARACTERISTICS/ 电气特性:

% of CURRENT RATING 额定电流的 %	BLOWING TIME 熔断时间
100%	4 hours Min. 最慢 4 小时
135%	1 hour Max. 最慢 1 小时
200%	10-30A 240 seconds Max. 最慢 240 秒 32A 360 seconds Max. 最慢 360 秒

HC14LgPV 平均 I-T 曲线图 (仅供参考)

AVERAGE I-T CHARACTERISTICS CURVE
(FOR REFERENCE ONLY)

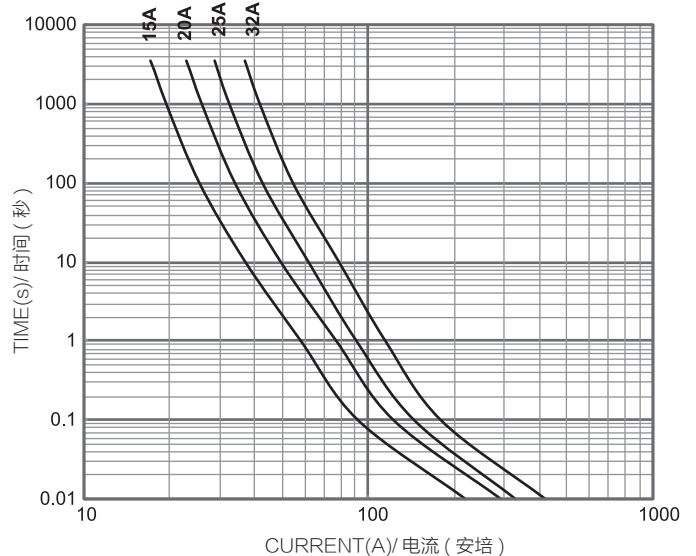



Your Power Safeguard™
您的电路安全卫士



HC10aR 250mA-32A

Class of Operation: aR

保护特性: aR



Standard/ 标准: IEC 60269-4, GB/T 13539.4, UL 248-13

TECHNICAL PARAMETERS/ 技术参数:

CATALOG NO. 目录编号	CURRENT RATING 额定电流	SAFETY APPROVALS 安全认证								
		CCC			VDE			cURus		
		U5 AC	U6 AC	U0 AC	U5 AC	U6 AC	U0 AC	U5 AC/DC	U6 AC/DC	U0 AC/DC
10aR0.25U5/U6/U0	250mA	●	●	●	●	●	●	●	●	●
10aR0.31U5/U6/U0	315mA	●	●	●	●	●	●	●	●	●
10aR0.4U5/U6/U0	400mA	●	●	●	●	●	●	●	●	●
10aR0.44U5/U6/U0	440mA	○	○	○	○	○	○	●	●	●
10aR0.5U5/U6/U0	500mA	●	●	●	●	●	●	●	●	●
10aR0.63U5/U6/U0	630mA	●	●	●	●	●	●	●	●	●
10aR0.8U5/U6/U0	800mA	●	●	●	●	●	●	●	●	●
10aR1U5/U6/U0	1A	●	●	●	●	●	●	●	●	●
10aR1.25U5/U6/U0	1.25A	●	●	●	●	●	●	●	●	●
10aR1.6U5/U6/U0	1.6A	●	●	●	●	●	●	●	●	●
10aR2U5/U6/U0	2A	●	●	●	●	●	●	●	●	●
10aR2.5U5/U6/U0	2.5A	●	●	●	●	●	●	●	●	●
10aR3U5/U6/U0	3A	●	●	●	●	●	●	●	●	●
10aR3.15U5/U6/U0	3.15A	●	●	●	●	●	●	●	●	●
10aR4U5/U6/U0	4A	●	●	●	●	●	●	●	●	●
10aR5U5/U6/U0	5A	●	●	●	●	●	●	●	●	●
10aR6U5/U6/U0	6A	●	●	●	●	●	●	●	●	●
10aR6.3U5/U6/U0	6.3A	●	●	●	●	●	●	●	●	●
10aR7U5/U6/U0	7A	●	●	●	●	●	●	●	●	●
10aR8U5/U6/U0	8A	●	●	●	●	●	●	●	●	●
10aR9U5/U6/U0	9A	●	●	●	●	●	●	●	●	●
10aR10U5/U6/U0	10A	●	●	●	●	●	●	●	●	●
10aR11U5/U6/U0	11A	○	○	○	○	○	○	●	●	●
10aR12U5/U6/U0	12A	●	●	●	●	○	○	●	●	●
10aR12.5U5/U6/U0	12.5A	●	●	●	●	○	○	●	●	●
10aR15U5/U6/U0	15A	●	●	●	●	○	○	●	●	●
10aR16U5/U6/U0	16A	●	●	●	●	○	○	●	●	●
10aR20U5/U6/U0	20A	●	●	●	●	○	○	●	●	●
10aR25U5/U6	25A	●	●	●	●	○	○	●	○	○
10aR30U5/U6	30A	●	●	●	●	○	○	●	○	○
10aR32U5/U6	32A	○	○	○	●	○	○	●	○	○

U5 DENOTES FOR 500V U5 表示 500V
U6 DENOTES FOR 690V U6 表示 690V
U0 DENOTES FOR 1000V U0 表示 1000V
● DENOTES FOR APPROVAL ● 表示已取得安全认证

Recommended fuseblocks/fuseholders for 10.3mmx38mm fuses

See Model of product: HC101A HC101D HF-103D HF-104A

适用于 10.3mmx38mm 熔断体的支持件

详见产品型号: HC101A HC101D HF-103D HF-104A



INTERRUPTING CAPACITY / 分断能力:

- 120,000 amperes at 500V AC (250mA-30A) CCC
- 120,000 amperes at 500V AC (250mA-32A) VDE/CURUS
- 80,000 amperes at 690V AC (250mA-30A) CCC
- 80,000 amperes at 690V AC (250mA-32A) VDE/CURUS
- 50,000 amperes at 1000V AC (250mA-30A) CCC
- 50,000 amperes at 1000V AC (250mA-20A) CURUS
- 50,000 amperes at 1000V AC (250mA-10A) VDE
- 120,000 amperes at 500V DC (250mA-32A) CURUS
- 50,000 amperes at 690V DC (250mA-32A) CURUS
- 30,000 amperes at 1000V DC (250mA-20A) CURUS

Dimensions/ 尺寸:

Unit 单位: mm

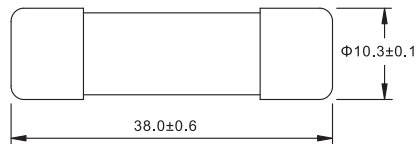

ELECTRICAL CHARACTERISTICS/ 电气特性:

% of CURRENT RATING 额定电流的 %	BLOWING TIME 熔断时间	
	250mA-5A	6A-32A
100%	最快 Min.	4 hours
	最慢 Max.	1 seconds
400%	最快 Min.	3 ms
	最慢 Max.	20 ms
1000%	最快 Min.	4 hours
	最慢 Max.	10 seconds
1000%	最快 Min.	3 ms
	最慢 Max.	10 ms
1000%	最快 Min.	20 ms
	最慢 Max.	30 ms

HC10aR 平均 I-T 曲线图 (仅供参考)

AVERAGE I-T CHARACTERISTICS CURVE (FOR REFERENCE ONLY)

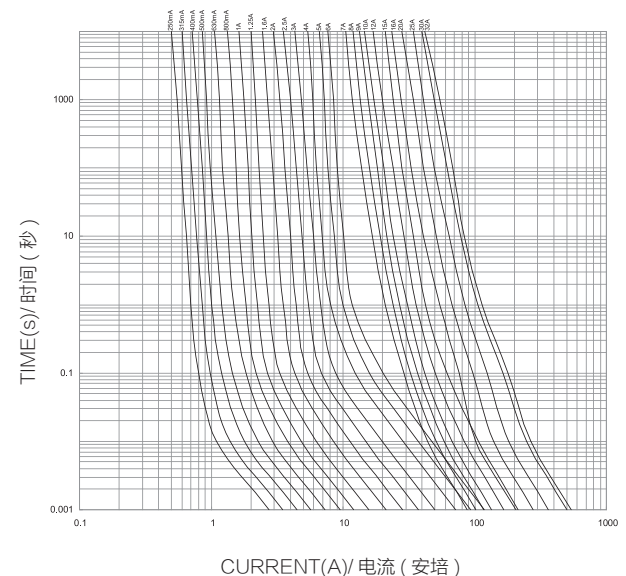



HC10aR-C 250mA-32A

Class of Operation: aR

保护特性: aR

Standard/ 标准: IEC 60269-4, GB/T 13539.4, UL 248-13

INTERRUPTING CAPACITY / 分断能力:

120,000 amperes at 500V AC (250mA-32A)
80,000 amperes at 690V AC (250mA-32A)
50,000 amperes at 1000V AC (250mA-20A)
120,000 amperes at 500V DC (250mA-32A)
50,000 amperes at 690V DC (250mA-32A)
30,000 amperes at 1000V DC (250mA-20A)

TECHNICAL PARAMETERS/ 技术参数:

CATALOG NO. 目录编号	CURRENT RATING 额定电流	SAFETY APPROVALS 安全认证		
		cURus		
		U5 AC/DC	U6 AC/DC	U0 AC/DC
10aR-C 0.25U5/U6/U0	250mA		○	
10aR-C 0.315U5/U6/U0	315mA		○	
10aR-C 0.4U5/U6/U0	400mA		○	
10aR-C 0.44U5/U6/U0	440mA		○	
10aR-C 0.5U5/U6/U0	500mA		○	
10aR-C 0.63U5/U6/U0	630mA		○	
10aR-C 0.8U5/U6/U0	800mA		○	
10aR-C 1U5/U6/U0	1A		○	
10aR-C 1.25U5/U6/U0	1.25A		○	
10aR-C 1.6U5/U6/U0	1.6A		○	
10aR-C 2U5/U6/U0	2A		○	
10aR-C 2.5U5/U6/U0	2.5A		○	
10aR-C 3U5/U6/U0	3A		○	
10aR-C 3.15U5/U6/U0	3.15A		○	
10aR-C 4U5/U6/U0	4A		○	
10aR-C 5U5/U6/U0	5A		○	
10aR-C 6U5/U6/U0	6A		○	
10aR-C 6.3U5/U6/U0	6.3A		○	
10aR-C 7U5/U6/U0	7A		○	
10aR-C 8U5/U6/U0	8A		○	
10aR-C 9U5/U6/U0	9A		○	
10aR-C 10U5/U6/U0	10A		○	
10aR-C 11U5/U6/U0	11A		○	
10aR-C 12U5/U6/U0	12A		○	
10aR-C 12.5U5/U6/U0	12.5A		○	
10aR-C 15U5/U6/U0	15A		○	
10aR-C 16U5/U6/U0	16A		○	
10aR-C 20U5/U6/U0	20A		○	
10aR-C 25U5/U6	25A		○	
10aR-C 30U5/U6	30A		○	
10aR-C 32U5/U6	32A		○	

U5 DENOTES FOR 500V DC U5 表示 500V
U6 DENOTES FOR 690V DC U6 表示 690V
U0 DENOTES FOR 1000V DC U0 表示 1000V
○ DENOTES FOR PENDING ○ 表示正在申请安全认证

Dimensions/ 尺寸:

Unit 单位: mm

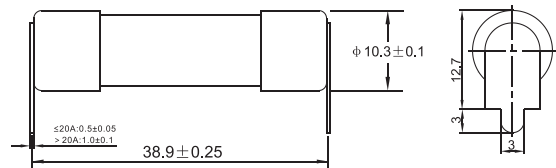

ELECTRICAL CHARACTERISTICS/ 电气特性:

% of CURRENT RATING 额定电流的 %	BLOWING TIME 熔断时间		
		250mA-5A	6A-32A
100%	最快 Min.	4 hours	4 hours
400%	最慢 Max.	1 seconds	10 seconds
	最快 Min.	3 ms	10 ms
1000%	最慢 Max.	20 ms	30 ms

HC10aR-C 平均 I-T 曲线图 (仅供参考)

AVERAGE I-T CHARACTERISTICS CURVE
(FOR REFERENCE ONLY)

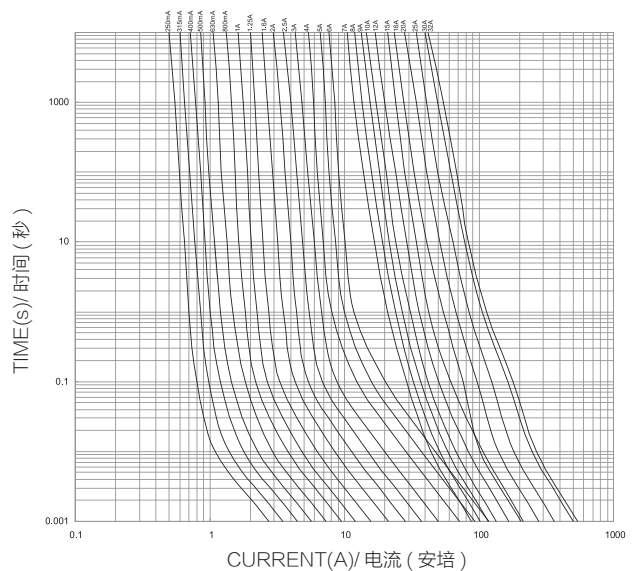



HC10gG 0.5A-32A

Class of Operation:gG

保护特性: gG

Standard/ 标准: IEC 60269, GB 13539



INTERRUPTING CAPACITY / 分断能力:

120,000 amperes at 400V AC (32A)
120,000 amperes at 500V AC (0.5A-25A)
80,000 amperes at 690V AC (0.5A-10A)

Dimensions/ 尺寸:

Unit 单位: mm

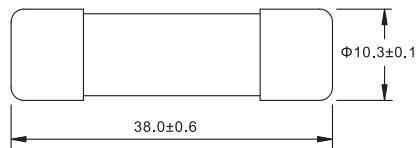

TECHNICAL PARAMETERS/ 技术参数:

CATALOG NO. 目录编号	CURRENT RATING 额定电流	SAFETY APPROVALS 安全认证		
		CCC	TUV	cURus
10gG0.5U5/U6	500mA	○	○	○
10gG1U5/U6	1A	○	○	○
10gG2U5/U6	2A	●	○	○
10gG4U5/U6	4A	●	○	○
10gG6U5/U6	6A	●	○	○
10gG8U5/U6	8A	●	○	○
10gG10U5/U6	10A	●	○	○
10gG12U5	12A	●	○	○
10gG16U5	16A	●	○	○
10gG20U5	20A	●	○	○
10gG25U5	25A	●	○	○
10gG32U4	32A	○	○	○

U4 DENOTES FOR 400V AC
U5 DENOTES FOR 500V AC
U6 DENOTES FOR 690V AC
● DENOTES FOR APPROVAL
○ DENOTES FOR PENDING

U4 表示 400V AC
U5 表示 500V AC
U6 表示 690V AC
● 表示已取得安全认证
○ 表示正在申请安全认证

Recommended fuseblocks/fuseholders for 10.3mmx38mm fuses

See Model of product: HC101A HC101D HF-103D HF-104A

适用于 10.3mmx38mm 熔断体的支持件

详见产品型号: HC101A HC101D HF-103D HF-104A



ELECTRICAL CHARACTERISTICS/ 电气特性:

RATING 额定	CONVENTIONAL TIME 约定时间	CONVENTIONAL CURRENT 约定电流	
		CONVENTIONAL NON-FUSING CURRENT(A) 约定不熔断电流	CONVENTIONAL FUSING CURRENT(A) 约定熔断电流
$I_n \leq 4A$	1h	$1.5I_n$	$2.1I_n$
$4A < I_n < 16A$	1h	$1.5I_n$	$1.9I_n$
$16 \leq I_n \leq 32A$	1h	$1.25I_n$	$1.6I_n$

HC10gG 平均 I-T 曲线图 (仅供参考)

AVERAGE I-T CHARACTERISTICS CURVE (FOR REFERENCE ONLY)

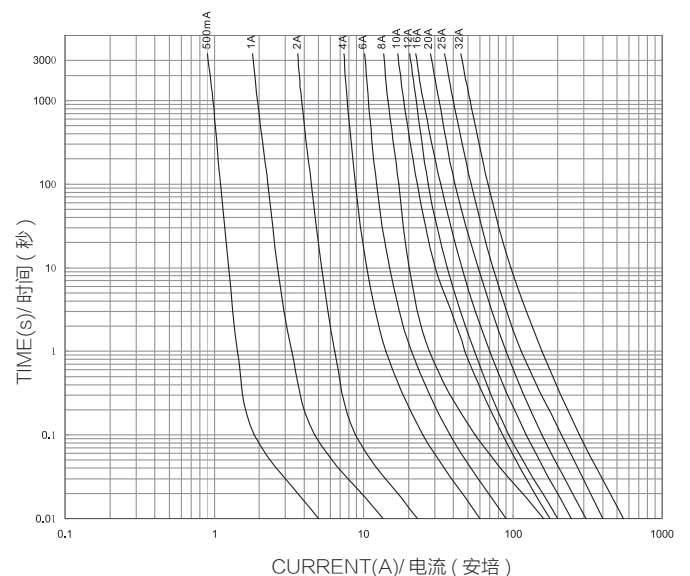



HC10aM 0.5A-32A

Class of Operation: aM

保护特性: aM

Standard/ 标准: IEC 60269, GB 13539



INTERRUPTING CAPACITY / 分断能力:

120,000 amperes at 500V AC (500mA-16A)

120,000 amperes at 400V AC (20A-32A)

Dimensions/ 尺寸:

Unit 单位: mm

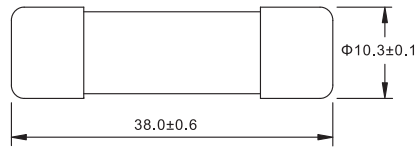

TECHNICAL PARAMETERS/ 技术参数:

CATALOG NO. 目录编号	CURRENT RATING 额定电流	APPROVALS 安全认证		
		CCC	TUV	cURus
10aM0.5U5	500mA	●	○	○
10aM1U5	1A	●	○	○
10aM2U5	2A	●	○	○
10aM4U5	4A	●	○	○
10aM6U5	6A	●	○	○
10aM8U5	8A	●	○	○
10aM10U5	10A	●	○	○
10aM12U5	12A	●	○	○
10aM16U5	16A	●	○	○
10aM20U4	20A	○	○	○
10aM25U4	25A	○	○	○
10aM30U4	30A	○	○	○
10aM32U4	32A	○	○	○

U4 DENOTES FOR 400V AC
U5 DENOTES FOR 500V AC
● DENOTES FOR APPROVAL
○ DENOTES FOR PENDING

U4 表示 400V AC
U5 表示 500V AC
● 表示已取得安全认证
○ 表示正在申请安全认证

ELECTRICAL CHARACTERISTICS/ 电气特性:

	4In	6.3In	8In	10In	12.5In	19In
t 熔断 Operating	—	60s	—	—	0.5s	0.1s
t 弧前 Pre-arcing	60s	—	0.5s	0.2s	—	—

HC10aM 平均 I-T 曲线图 (仅供参考)

AVERAGE I-T CHARACTERISTICS CURVE
(FOR REFERENCE ONLY)

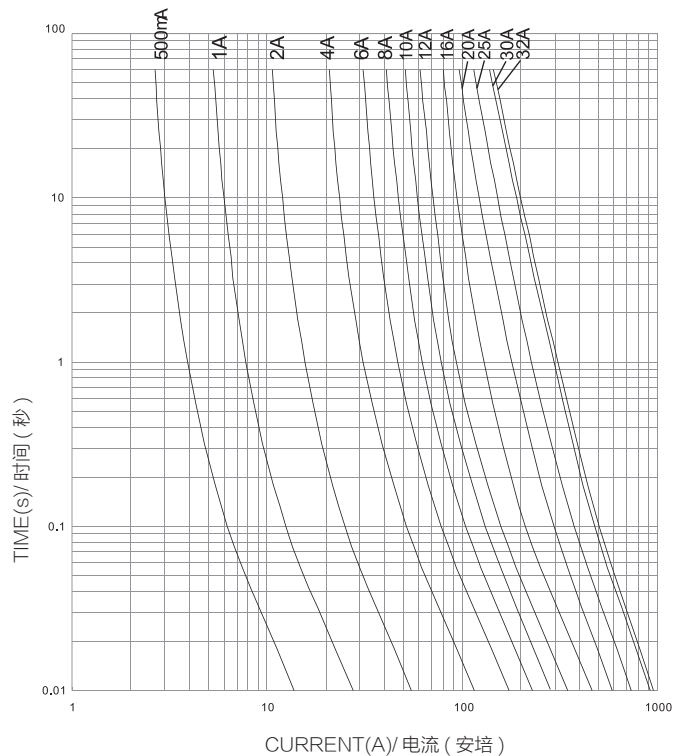

Recommended fuseblocks/fuseholders for 10.3mmx38mm fuses

See Model of product: HC101A HC101D HF-103D HF-104A

适用于 10.3mmx38mm 熔断体的支持件

详见产品型号: HC101A HC101D HF-103D HF-104A

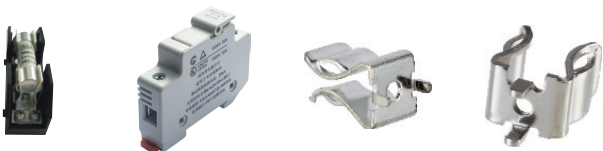



Your Power Safeguard™
您的电路安全卫士



HC10N 1A-30A Fast-Acting Fuses 速断型熔断器

Standard/ 标准: UL 248



INTERRUPTING CAPACITY / 分断能力:

100,000 amperes at 600V AC (1A-30A)

10,000 amperes at 600V DC (1A-30A)

Dimensions/ 尺寸:

Unit 单位: mm

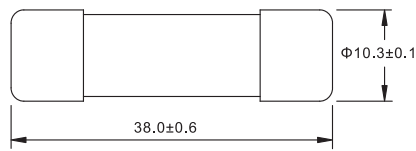

TECHNICAL PARAMETERS/ 技术参数:

CATALOG NO. 目录编号	CURRENT RATING 额定电流	SAFETY APPROVALS 安全认证			
		UL		CUL	
		AC	DC	AC	DC
10N1U6	1A	●	●	●	●
10N1.25U6	1.25A	●	●	●	●
10N1.5U6	1.5A	●	●	●	●
10N1.6U6	1.6A	●	●	●	●
10N2U6	2A	●	●	●	●
10N2.5U6	2.5A	●	●	●	●
10N3U6	3A	●	●	●	●
10N3.15U6	3.15A	●	●	●	●
10N3.5U6	3.5A	●	●	●	●
10N4U6	4A	●	●	●	●
10N5U6	5A	●	●	●	●
10N6U6	6A	●	●	●	●
10N6.3U6	6.3A	●	●	●	●
10N7U6	7A	●	●	●	●
10N8U6	8A	●	●	●	●
10N9U6	9A	●	●	●	●
10N10U6	10A	●	●	●	●
10N12U6	12A	●	●	●	●
10N15U6	15A	●	●	●	●
10N16U6	16A	●	●	●	●
10N20U6	20A	●	●	●	●
10N25U6	25A	●	●	●	●
10N30U6	30A	●	●	●	●

U6 DENOTES FOR 600V AC

● DENOTES FOR APPROVAL

○ DENOTES FOR PENDING

U6 表示 600V AC

● 表示已取得安全认证

○ 表示正在申请安全认证

Recommended fuseblocks/fuseholders for 10.3mmx38mm fuses

See Model of product: HC101A HC101D HF-103D HF-104A

适用于 10.3mmx38mm 熔断体的支持件

详见产品型号: HC101A HC101D HF-103D HF-104A



ELECTRICAL CHARACTERISTICS/ 电气特性:

% of CURRENT RATING 额定电流的 %	BLOWING TIME 熔断时间	
100%	4 hours Min.	最快 4 小时
135%	1 hour Max.	最慢 1 小时
200%	120 seconds Max.	最慢 120 秒

HC10N 平均 I-T 曲线图 (仅供参考)

AVERAGE I-T CHARACTERISTICS CURVE
(FOR REFERENCE ONLY)

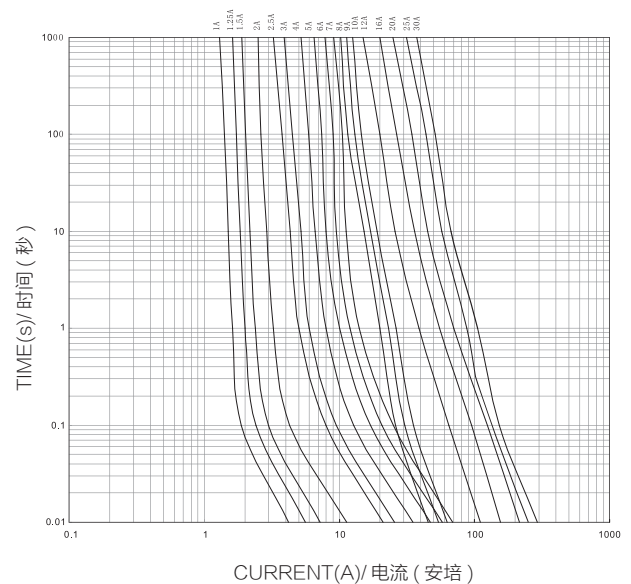



HC10S 500mA-30A Time-Delay Fuses 延时型熔断器

Standard/ 标准: UL 248



INTERRUPTING CAPACITY / 分断能力

10,000 amperes at 500V AC (300mA-30A)

Dimensions/ 尺寸:

Unit 单位: mm

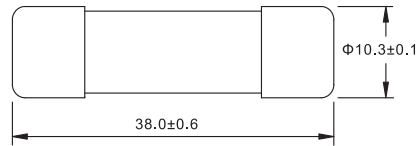

TECHNICAL PARAMETERS/ 技术参数:

CATALOG NO. 目录编号	CURRENT RATING 额定电流	SAFETY APPROVALS 安全认证	
		UL	CUL
10S0.5U5	500mA	●	●
10S0.63U5	630mA	●	●
10S0.7U5	700mA	●	●
10S0.75U5	750mA	●	●
10S0.8U5	800mA	●	●
10S1U5	1A	●	●
10S1.25U5	1.25A	●	●
10S1.5U5	1.5A	●	●
10S1.6U5	1.6A	●	●
10S2U5	2A	●	●
10S2.5U5	2.5A	●	●
10S3U5	3A	●	●
10S3.15U5	3.15A	●	●
10S3.5U5	3.5A	●	●
10S4U5	4A	●	●
10S5U5	5A	●	●
10S6U5	6A	●	●
10S6.3U5	6.3A	●	●
10S7U5	7A	●	●
10S8U5	8A	●	●
10S9U5	9A	●	●
10S10U5	10A	●	●
10S12U5	12A	●	●
10S15U5	15A	●	●
10S16U5	16A	●	●
10S20U5	20A	●	●
10S25U5	25A	●	●
10S30U5	30A	●	●

U5 DENOTES FOR 500V AC
● DENOTES FOR APPROVAL
○ DENOTES FOR PENDING

U5 表示 500V AC
● 表示已取得安全认证
○ 表示正在申请安全认证

ELECTRICAL CHARACTERISTICS/ 电气特性:

% of CURRENT RATING 额定电流的 %	BLOWING TIME 熔断时间	
100%	4 hours Min.	最快 4 小时
135%	1 hour Max.	最慢 1 小时
200%	500mA-3A	5-120 seconds 5-120 秒
	3.15A-30A	12-120 seconds 12-120 秒

HC10S 平均 I-T 曲线图 (仅供参考)

AVERAGE I-T CHARACTERISTICS CURVE
(FOR REFERENCE ONLY)

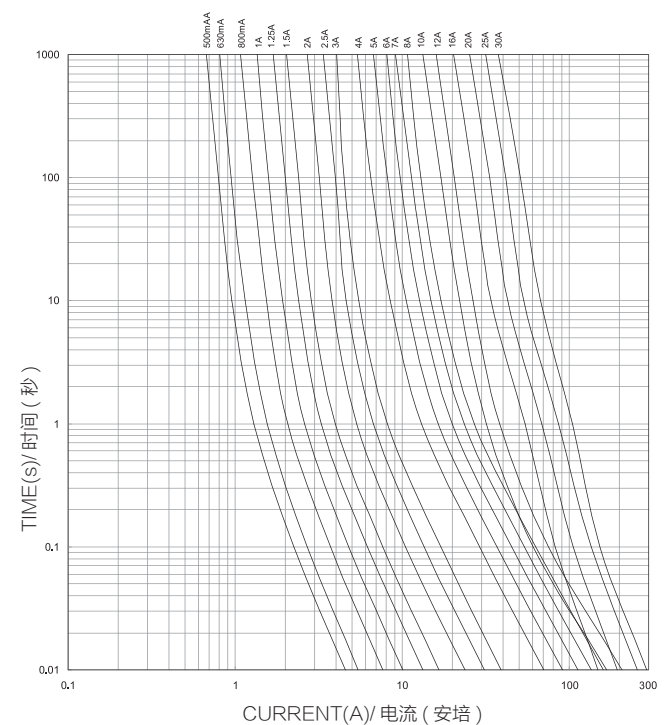

Recommended fuseblocks/fuseholders for 10.3mmx38mm fuses

See Model of product: HC101A HC101D HF-103D HF-104A

适用于 10.3mmx38mm 熔断体的支持件

详见产品型号: HC101A HC101D HF-103D HF-104A





Your Power Safeguard™
您的电路安全卫士



HC10NR 1A-30A

Fast-Acting Fuses

Class CC

速断型熔断器

Standard/ 标: UL 248-4



INTERRUPTING CAPACITY / 分断能力:

200,000 amperes at 600V AC (1A-30A)
20,000 amperes at 300V DC (1A-30A)

TECHNICAL PARAMETERS/ 技术参数:

CATALOG NO. 目录编号	CURRENT RATING 额定电流	SAFETY APPROVALS 安全认证	
		UL	CUL
10NR1U6	1A	●	●
10NR1.25U6	1.25A	●	●
10NR1.5U6	1.5A	●	●
10NR1.6U6	1.6A	●	●
10NR2U6	2A	●	●
10NR2.5U6	2.5A	●	●
10NR3U6	3A	●	●
10NR3.15U6	3.15A	●	●
10NR3.5U6	3.5A	●	●
10NR4U6	4A	●	●
10NR5U6	5A	●	●
10NR6U6	6A	●	●
10NR6.3U6	6.3A	●	●
10NR7U6	7A	●	●
10NR8U6	8A	●	●
10NR9U6	9A	●	●
10NR10U6	10A	●	●
10NR12U6	12A	●	●
10NR15U6	15A	●	●
10NR16U6	16A	●	●
10NR20U6	20A	●	●
10NR25U6	25A	●	●
10NR30U6	30A	●	●

U6 DENOTES FOR 600V AC

● DENOTES FOR APPROVAL

○ DENOTES FOR PENDING

U6 表示 600V AC

● 表示已取得安全认证

○ 表示正在申请安全认证

Dimensions/ 尺寸:

Unit 单位: mm

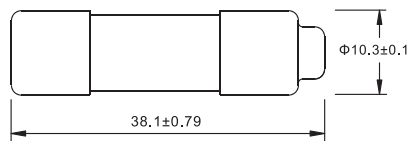

ELECTRICAL CHARACTERISTICS/ 电气特性:

% of CURRENT RATING 额定电流的 %	BLOWING TIME 熔断时间	
110%	15 minutes Min.	最快 15 分钟
135%	1 hour Max.	最慢 1 小时
200%	4 minutes Max.	最慢 4 分钟

HC10NR 平均 I-T 曲线图 (仅供参考)

AVERAGE I-T CHARACTERISTICS CURVE
(FOR REFERENCE ONLY)

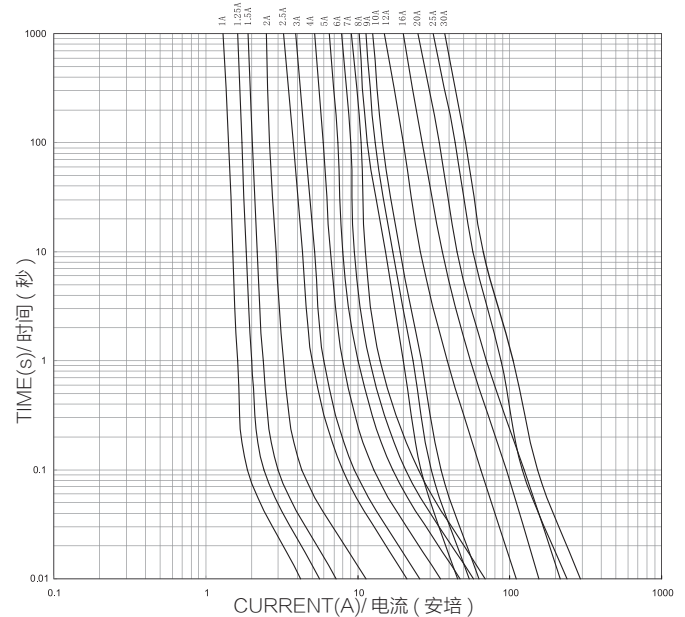

Recommended fuseholders for Class CC 600V fuses

See Model of product: HC101C

适用于 CC 型熔断体的支持件

详见产品型号: HC101C





HC10SR 1A-30A

Time-Delay Fuses

Class CC

延时型熔断器

Standard/ 标准: UL 248-4



INTERRUPTING CAPACITY / 分断能力

200,000 amperes at 600V AC (1A-30A)

10,000 amperes at 300V DC (9A-30A)

TECHNICAL PARAMETERS/ 技术参数:

CATALOG NO. 目录编号	CURRENT RATING 额定电流	SAFETY APPROVALS 安全认证	
		UL	CUL
10SR1U6	1A	●	●
10SR1.25U6	1.25A	●	●
10SR1.5U6	1.5A	●	●
10SR1.6U6	1.6A	●	●
10SR2U6	2A	●	●
10SR2.5U6	2.5A	●	●
10SR3U6	3A	●	●
10SR3.15U6	3.15A	●	●
10SR3.5U6	3.5A	●	●
10SR4U6	4A	●	●
10SR5U6	5A	●	●
10SR6U6	6A	●	●
10SR6.3U6	6.3A	●	●
10SR7U6	7A	●	●
10SR8U6	8A	●	●
10SR9U6	9A	●	●
10SR10U6	10A	●	●
10SR12U6	12A	●	●
10SR15U6	15A	●	●
10SR16U6	16A	●	●
10SR20U6	20A	●	●
10SR25U6	25A	●	●
10SR30U6	30A	●	●

U6 DENOTES FOR 600V AC
● DENOTES FOR APPROVAL
○ DENOTES FOR PENDING

U6 表示 600V AC
● 表示已取得安全认证
○ 表示正在申请安全认证

Dimensions/ 尺寸:

Unit 单位: mm

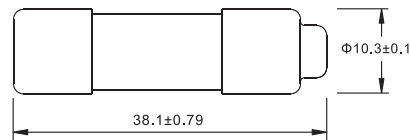

ELECTRICAL CHARACTERISTICS/ 电气特性:

% of CURRENT RATING 额定电流的 %	BLOWING TIME 熔断时间	
110%	15 minutes Min.	最快 15 分钟
135%	1 hour Max.	最慢 1 小时
200%	12 seconds-240 seconds	12 秒 -240 秒

HC10SR 平均 I-T 曲线图 (仅供参考)

AVERAGE I-T CHARACTERISTICS CURVE
(FOR REFERENCE ONLY)

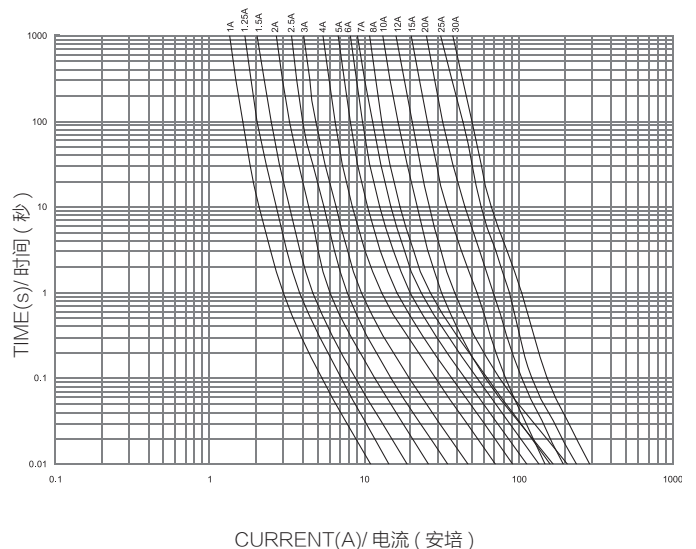

Recommended fuseholders for Class CC 600V fuses

See Model of product: HC101C

适用于 CC 型熔断体的支持件

详见产品型号: HC101C





HC14gG 2A-50A

Class of Operation: gG
保护特性: gG

Standard/ 标准: IEC 60269, GB 13539



INTERRUPTING CAPACITY / 分断能力:

120,000 amperes at 500V AC (2A-50A)
80,000 amperes at 690V AC (2A-25A)

Dimensions/ 尺寸:

Unit 单位: mm

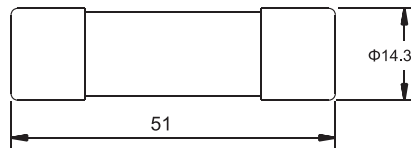

TECHNICAL PARAMETERS/ 技术参数:

CATALOG NO. 目录编号	CURRENT RATING 额定电流	SAFETY APPROVALS 安全认证		
		CCC	TUV	cURus
14gG2U5/U6	2A	●	○	○
14gG4U5/U6	4A	●	○	○
14gG6U5/U6	6A	●	○	○
14gG8U5/U6	8A	●	○	○
14gG10U5/U6	10A	●	○	○
14gG12U5/U6	12A	●	○	○
14gG16U5/U6	16A	●	○	○
14gG20U5/U6	20A	●	○	○
14gG25U5/U6	25A	●	○	○
14gG32U5	32A	●	○	○
14gG40U5	40A	●	○	○
14gG50U5	50A	●	○	○

U5 DENOTES FOR 500V AC
U6 DENOTES FOR 690V AC
● DENOTES FOR APPROVAL
○ DENOTES FOR PENDING

U5 表示 500V AC
U6 表示 690V AC
● 表示已取得安全认证
○ 表示正在申请安全认证

Recommended fuse-base for 14.3mmx51mm fuses

See Model of product: HC141A HC141B

适用于 14.3mmx51mm 熔断体的支持件

详见产品型号: HC141A HC141B



ELECTRICAL CHARACTERISTICS/ 电气特性:

RATING 额定	CONVENTIONAL TIME 约定时间	CONVENTIONAL CURRENT 约定电流	
		CONVENTIONAL NON-FUSING CURRENT(A) 约定不熔断电流	CONVENTIONAL FUSING CURRENT(A) 约定熔断电流
$I_n \leq 4A$	1h	$1.5I_n$	$2.1I_n$
$4A < I_n < 16A$	1h	$1.5I_n$	$1.9I_n$
$16 \leq I_n \leq 50A$	1h	$1.25I_n$	$1.6I_n$

HC14gG 平均 I-T 曲线图 (仅供参考)

AVERAGE I-T CHARACTERISTICS CURVE (FOR REFERENCE ONLY)

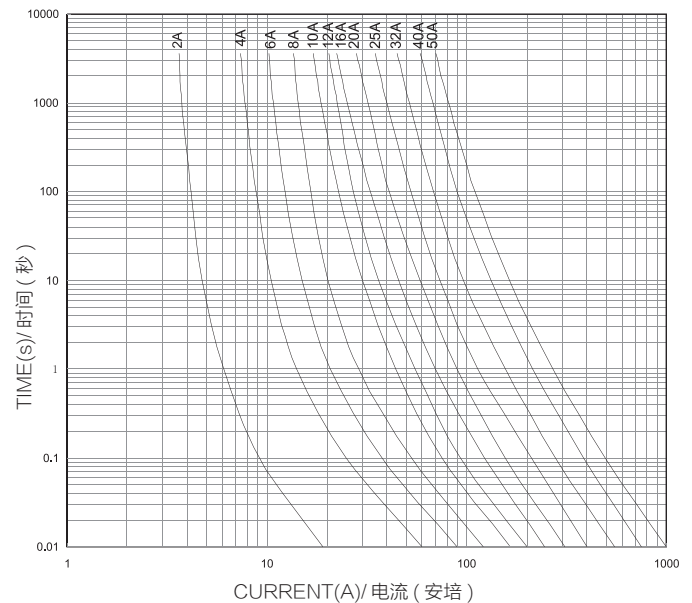



aR TYPE

Class of Operation: aR

保护特性: aR

Standard/ 标准: IEC 60269-4, GB/T 13539.4

Dimensions/ 尺寸:

Unit 单位: mm

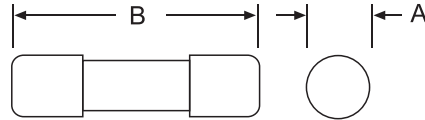

尺寸/型号 SIZE/TYPE	HC08aR	HC14aR	HC22aR
A	8.5	14.3	22.2
B	31.5	51.0	58.0

TECHNICAL PARAMETERS/ 技术参数:

TYPE/ SIZE 型号 / 尺寸	CATALOG NO. 目录编号	CURRENT RATING 额定电流	VOLTAGE RATING 额定电压	BREAKING CAPACITY 分断能力	SAFETY APPROVALS 安全认证		
					CCC	TUV	cURus
HC08aR (8.5x31.5mm)	08aR0.5U4	500mA	400V		○	○	○
	08aR0.63U4	630mA	400V		○	○	○
	08aR0.8U4	800mA	400V		○	○	○
	08aR1U4	1A	400V		○	○	○
	08aR1.25U4	1.25A	400V		○	○	○
	08aR1.6U4	1.6A	400V		○	○	○
	08aR2U4	2A	400V		○	○	○
	08aR2.5U4	2.5A	400V		○	○	○
	08aR3U4	3A	400V		○	○	○
	08aR3.5U4	3.5A	400V		○	○	○
	08aR4U4	4A	400V		○	○	○
	08aR5U4	5A	400V		○	○	○
	08aR6U4	6A	400V		○	○	○
	08aR6.3U4	6.3A	400V		○	○	○
	08aR7U4	7A	400V		○	○	○
	08aR8U4	8A	400V		○	○	○
	08aR9U4	9A	400V		○	○	○
	08aR10U4	10A	400V		○	○	○
	08aR12U4	12A	400V		○	○	○
	08aR12.5U4	12.5A	400V		○	○	○
08aR15U4	15A	400V		○	○	○	
08aR16U4	16A	400V		○	○	○	
08aR20U4	20A	400V		○	○	○	
08aR25U4	25A	400V		○	○	○	
HC14aR (14.3x51mm)	14aR4U5/U6	4A	500V/690V		○	○	○
	14aR5U5/U6	5A	500V/690V		○	○	○
	14aR6U5/U6	6A	500V/690V		○	○	○
	14aR7U5/U6	7A	500V/690V		○	○	○
	14aR8U5/U6	8A	500V/690V		○	○	○
	14aR9U5/U6	9A	500V/690V		○	○	○
	14aR10U5/U6	10A	500V/690V	120KA(500V)	○	○	○
	14aR12U5/U6	12A	500V/690V	80KA(690V)	○	○	○
	14aR15U5/U6	15A	500V/690V		○	○	○
	14aR16U5/U6	16A	500V/690V		○	○	○
	14aR20U5/U6	20A	500V/690V		○	○	○
	14aR25U5/U6	25A	500V/690V		○	○	○
14aR30U5/U6	30A	500V/690V		○	○	○	
14aR32U5/U6	32A	500V/690V		○	○	○	
14aR40U5	40A	500V		○	○	○	
14aR50U5	50A	500V	120KA	○	○	○	
HC22aR (22.2x58mm)	22aR4U5/U6	4A	500V/690V		○	○	○
	22aR5U5/U6	5A	500V/690V		○	○	○
	22aR6U5/U6	6A	500V/690V		○	○	○
	22aR7U5/U6	7A	500V/690V		○	○	○
	22aR8U5/U6	8A	500V/690V		○	○	○
	22aR9U5/U6	9A	500V/690V		○	○	○
	22aR10U5/U6	10A	500V/690V		○	○	○
	22aR12U5/U6	12A	500V/690V	120KA(500V)	○	○	○
	22aR15U5/U6	15A	500V/690V		○	○	○
	22aR16U5/U6	16A	500V/690V	80KA(690V)	○	○	○
	22aR20U5/U6	20A	500V/690V		○	○	○
	22aR25U5/U6	25A	500V/690V		○	○	○
	22aR30U5/U6	30A	500V/690V		○	○	○
	22aR32U5/U6	32A	500V/690V		○	○	○
22aR40U5/U6	40A	500V/690V		○	○	○	
22aR50U5/U6	50A	500V/690V		○	○	○	
22aR63U5/U6	63A	500V/690V		○	○	○	
22aR80U5	80A	500V	120KA	○	○	○	
22aR100U5	100A	500V		○	○	○	

ELECTRICAL CHARACTERISTICS/ 电气特性:

RATING 额定	BLOWING TIME 熔断时间	
	250mA-5A	6A-100A
1.0In	最快 Min.	4 hours
4In	最慢 Max.	1 s
	最快 Min.	3 ms
10In	最慢 Max.	20 ms
		30 ms

HCaR 平均 I-T 曲线图 (仅供参考)

AVERAGE I-T CHARACTERISTICS CURVE
(FOR REFERENCE ONLY)

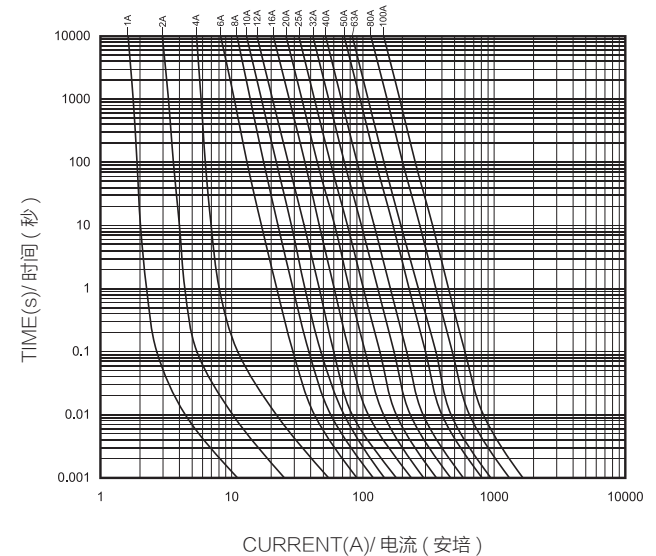

U4 DENOTES FOR 400V AC
U5 DENOTES FOR 500V AC
U6 DENOTES FOR 690V AC
● DENOTES FOR APPROVAL
○ DENOTES FOR PENDING

U4 表示 400V AC
U5 表示 500V AC
U6 表示 690V AC
● 表示已取得安全认证
○ 表示正在申请安全认证



Your Power Safeguard™
您的电路安全卫士



gG TYPE

Class of Operation: gG

保护特性: gG

Standard/ 标准: IEC 60269, GB 13539

Dimensions/ 尺寸:

Unit 单位: mm

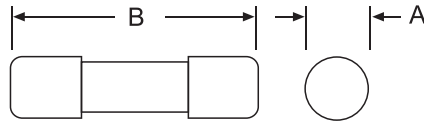

尺寸/型号 SIZE/TYPE	HC08gG	HC22gG
A	8.5	22.2
B	31.5	58.0

TECHNICAL PARAMETERS/ 技术参数:

TYPE/SIZE 型号 / 尺寸	CATALOG NO. 目录编号	CURRENT RATING 额定电流	VOLTAGE RATING 额定电压	BREAKING CAPACITY 分断能力	SAFETY APPROVALS 安全认证		
					CCC	TUV	cURus
HC08gG (8.5x31.5mm)	08gG0.5U4	500mA	400V		○	○	○
	08gG1U4	1A	400V		○	○	○
	08gG2U4	2A	400V		○	○	○
	08gG4U4	4A	400V		○	○	○
	08gG6U4	6A	400V		○	○	○
	08gG8U4	8A	400V	20KA	○	○	○
	08gG10U4	10A	400V		○	○	○
	08gG12U4	12A	400V		○	○	○
	08gG16U4	16A	400V		○	○	○
	08gG20U4	20A	400V		○	○	○
HC22gG (22.2x58mm)	22gG25U4	25A	400V		○	○	○
	22gG4U5/U6	4A	500V/690V		○	○	○
	22gG6U5/U6	6A	500V/690V		○	○	○
	22gG8U5/U6	8A	500V/690V		○	○	○
	22gG10U5/U6	10A	500V/690V		○	○	○
	22gG12U5/U6	12A	500V/690V		○	○	○
	22gG16U5/U6	16A	500V/690V	120KA(500V) 80KA(690V)	○	○	○
	22gG20U5/U6	20A	500V/690V		○	○	○
	22gG25U5/U6	25A	500V/690V		○	○	○
	22gG32U5/U6	32A	500V/690V		○	○	○
	22gG40U5/U6	40A	500V/690V		○	○	○
	22gG50U5/U6	50A	500V/690V		○	○	○
	22gG63U5	63A	500V		○	○	○
	22gG80U5	80A	500V	120KA	○	○	○
	22gG100U5	100A	500V		○	○	○
22gG125U5	125A	500V		○	○	○	

U4 DENOTES FOR 400V AC
U5 DENOTES FOR 500V AC
U6 DENOTES FOR 690V AC
● DENOTES FOR APPROVAL
○ DENOTES FOR PENDING

U4 表示 400V AC
U5 表示 500V AC
U6 表示 690V AC
● 表示已取得安全认证
○ 表示正在申请安全认证

ELECTRICAL CHARACTERISTICS/ 电气特性:

RATING 额定	CONVENTIONAL TIME 约定时间	CONVENTIONAL CURRENT 约定电流	
		CONVENTIONAL NON-FUSING CURRENT(A) 约定不熔断电流	CONVENTIONAL FUSING CURRENT(A) 约定熔断电流
$I_n \leq 4A$	1h	1.5I _n	2.1I _n
$4A < I_n < 16A$	1h	1.5I _n	1.9I _n
$16 \leq I_n \leq 63A$	1h	1.25I _n	1.6I _n
$63 < I_n \leq 125A$	2h	1.25I _n	1.6I _n

HCgG 平均 I-T 曲线图 (仅供参考)

AVERAGE I-T CHARACTERISTICS CURVE (FOR REFERENCE ONLY)

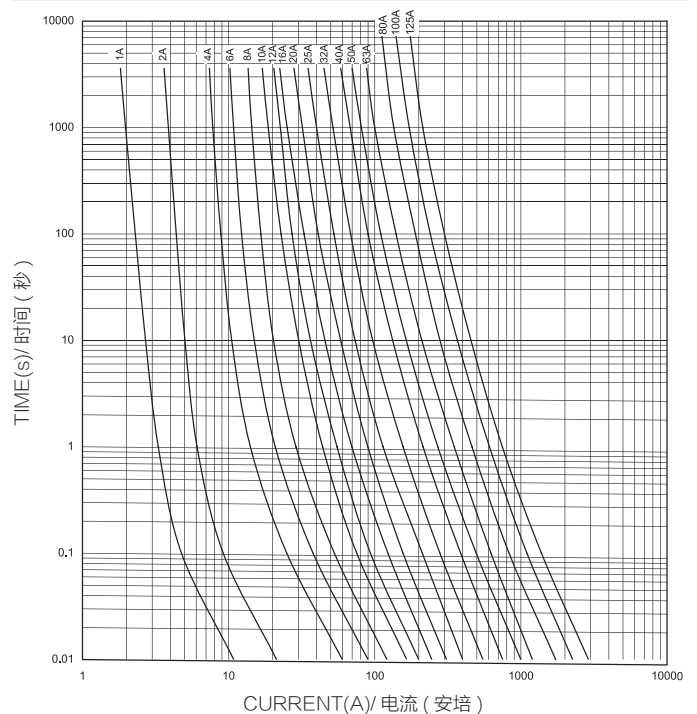



aM TYPE

Class of Operation: aM

保护特性: aM

Standard/ 标准: IEC 60269-2, GB/T13539.2

Dimensions/ 尺寸:

Unit 单位: mm

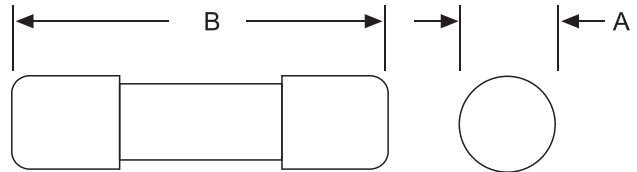

TECHNICAL PARAMETERS/ 技术参数:

TYPE/SIZE 型号/尺寸	CATALOG NO. 目录编号	CURRENT RATING 额定电流	VOLTAGE RATING 额定电压	BREAKING CAPACITY 分断能力	SAFETY APPROVALS 安全认证		
					CCC	TUV	cURus
HC08aM (8.5x31.5mm)	08aM1U4	1A	400V	20KA	○	○	○
	08aM2U4	2A	400V		○	○	○
	08aM4U4	4A	400V		○	○	○
	08aM6U4	6A	400V		○	○	○
	08aM8U4	8A	400V		○	○	○
HC14aM (14.3x51mm)	14aM10U4	10A	400V	120KA(500V) 80KA(690V)	○	○	○
	14aM2U5/U6	2A	500V/690V		○	○	○
	14aM4U5/U6	4A	500V/690V		○	○	○
	14aM6U5/U6	6A	500V/690V		○	○	○
	14aM8U5/U6	8A	500V/690V		○	○	○
	14aM10U5/U6	10A	500V/690V		○	○	○
	14aM12U5/U6	12A	500V/690V		○	○	○
	14aM16U5/U6	16A	500V/690V		○	○	○
	14aM20U5/U6	20A	500V/690V		○	○	○
	14aM25U5/U6	25A	500V/690V		○	○	○
HC22aM (22.2x58mm)	14aM32U5	32A	500V	120KA	○	○	○
	14aM40U5	40A	500V		○	○	○
	14aM50U5	50A	400V		○	○	○
	22aM4U5/U6	4A	500V/690V		○	○	○
	22aM6U5/U6	6A	500V/690V		○	○	○
	22aM8U5/U6	8A	500V/690V		○	○	○
	22aM10U5/U6	10A	500V/690V		○	○	○
	22aM12U5/U6	12A	500V/690V		○	○	○
	22aM16U5/U6	16A	500V/690V		○	○	○
	22aM20U5/U6	20A	500V/690V		○	○	○
HC22aM (22.2x58mm)	22aM25U5/U6	25A	500V/690V	120KA	○	○	○
	22aM32U5/U6	32A	500V/690V		○	○	○
	22aM40U5/U6	40A	500V/690V		○	○	○
	22aM50U5/U6	50A	500V/690V		○	○	○
	22aM63U5	63A	500V		○	○	○
	22aM80U5	80A	500V		○	○	○
	22aM100U5	100A	500V		○	○	○
	22aM125U5	125A	500V		○	○	○

U4 DENOTES FOR 400V AC
U5 DENOTES FOR 500V AC
U6 DENOTES FOR 690V AC
● DENOTES FOR APPROVAL
○ DENOTES FOR PENDING

U4 表示 400V AC
U5 表示 500V AC
U6 表示 690V AC
● 表示已取得安全认证
○ 表示正在申请安全认证

ELECTRICAL CHARACTERISTICS/ 电气特性:

	4In	6.3In	8In	10In	12.5In	19In
t _{熔断} Operating	—	60s	—	—	0.5s	0.1s
t _{弧前} Pre-arcing	60s	—	0.5s	0.2s	—	—

HCaM 平均 I-T 曲线图 (仅供参考)

AVERAGE I-T CHARACTERISTICS CURVE
(FOR REFERENCE ONLY)

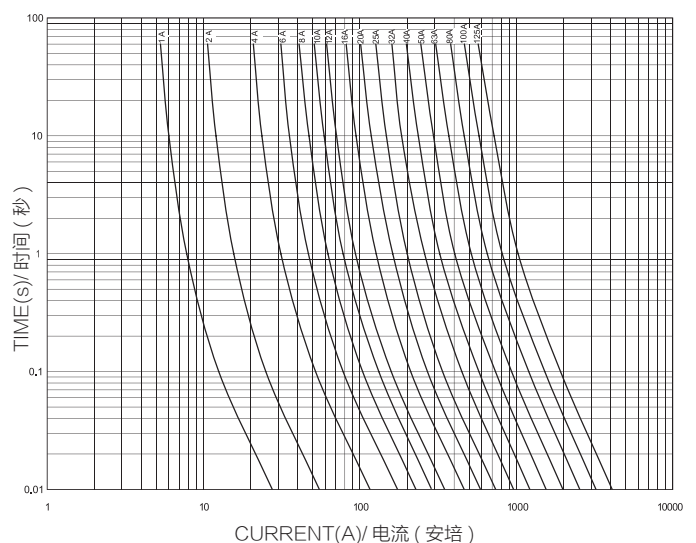



HBC 35A-1200A

Class of Operation: aR

保护特性: aR

Standard/ 标准: IEC 60269-4, GB/T 13539.4, UL 248-13

INTERRUPTING CAPACITY / 分断能力:
200,000 amperes at 500V AC (35A-1200A)
50,000 amperes at 500V DC (35A-1200A)

TECHNICAL PARAMETERS/ 技术参数:

CATALOG NO. 目录编号	CURRENT RATING 额定电流	SAFETY APPROVALS 安全认证	
		cURus	
HBC35	35A	○	○
HBC40	40A	○	○
HBC45	45A	○	○
HBC50	50A	○	○
HBC60	60A	○	○
HBC70	70A	○	○
HBC80	80A	○	○
HBC90	90A	○	○
HBC100	100A	○	○
HBC125	125A	○	○
HBC150	150A	○	○
HBC175	175A	○	○
HBC200	200A	○	○
HBC225	225A	○	○
HBC250	250A	○	○
HBC275	275A	○	○
HBC300	300A	○	○
HBC325	325A	○	○
HBC350	350A	○	○
HBC400	400A	○	○
HBC450	450A	○	○
HBC500	500A	○	○
HBC600	600A	○	○
HBC700	700A	○	○
HBC800	800A	○	○
HBC1000	1000A	○	○
HBC1200	1200A	○	○

● DENOTES FOR APPROVAL ● 表示已取得安全认证
○ DENOTES FOR PENDING ○ 表示正在申请安全认证

Dimensions/ 尺寸:

Unit 单位: mm

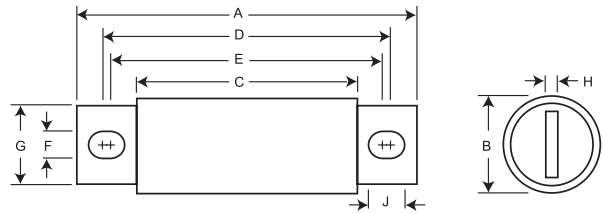

HBC 平均 I-T 曲线图 (仅供参考)

AVERAGE I-T CHARACTERISTICS CURVE
(FOR REFERENCE ONLY)

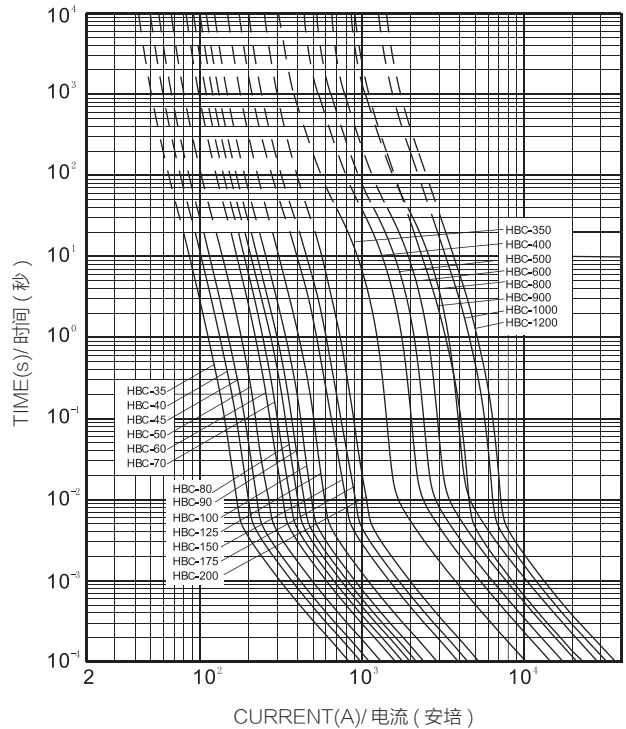

CATALOG NUMBER	A	B	C	D	E	F	G	H	J
HBC35 to 100	92	25.1	54	77	71.6	8.2	18	3.2	10.8
HBC125 to 200	92	31	54	75.6	72	8.6	24	4.8	10.4
HBC225 to 400	110	38	54	88	74.4	10.4	25.4	6.4	17.2
HBC450 to 600	110	50.8	54	90	74.4	10.4	38	6.4	18.2
HBC700 to 800	161	63.5	54	126.2	87.8	13.5	50	9.6	32.7
HBC1000 to 1200	177	76.2	82	137.8	112.4	15.8	60	11	28.5



HBD 35A-600A

Class of Operation: aR

保护特性: aR

Standard/ 标准: IEC 60269-4, GB/T 13539.4, UL248-13

INTERRUPTING CAPACITY / 分断能力:

200,000 amperes at 700V AC (35A-600A)

50,000 amperes at 700V DC (35A-600A)

TECHNICAL PARAMETERS/ 技术参数:

CATALOG NO. 目录编号	CURRENT RATING 额定电流	SAFETY APPROVALS 安全认证
		cURus
HBD35	35A	○
HBD40	40A	○
HBD50	50A	○
HBD60	60A	○
HBD70	70A	○
HBD80	80A	○
HBD90	90A	○
HBD100	100A	○
HBD125	125A	○
HBD150	150A	○
HBD175	175A	○
HBD200	200A	○
HBD225	225A	○
HBD250	250A	○
HBD300	300A	○
HBD350	350A	○
HBD400	400A	○
HBD450	450A	○
HBD500	500A	○
HBD600	600A	○

● DENOTES FOR APPROVAL
○ DENOTES FOR PENDING

● 表示已取得安全认证
○ 表示正在申请安全认证

Dimensions/ 尺寸:

Unit 单位: mm

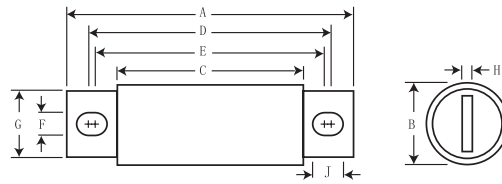

HBD 平均 I-T 曲线图 (仅供参考)

AVERAGE I-T CHARACTERISTICS CURVE
(FOR REFERENCE ONLY)

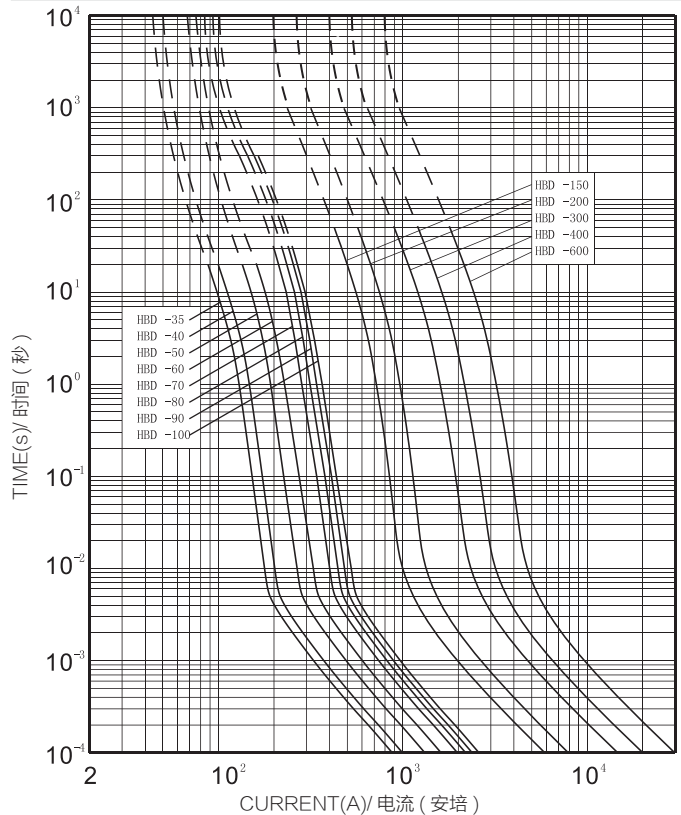

CATALOG NUMBER	A	B	C	D	E	F	G	H	J
HBD35 to 60	109	25.1	71	94	88.6	8.2	18	3.2	10.8
HBD70 to 100	109	31	71	92.6	89	8.6	24	4.8	12.4
HBD125 to 200	127	38	71	105	91.4	10.4	25.4	6.4	17.2
HBD225 to 400	127	50.8	71	107	91.4	10.4	38	6.4	18.2
HBD450 to 600	178	63.5	71	143.2	104.8	13.5	50	9.6	32.7



HBE 35A-800A

Class of Operation: aR

保护特性: aR

Standard/ 标准: IEC 60269-4, GB/T 13539.4, UL248-13

INTERRUPTING CAPACITY / 分断能力:
100,000 amperes at 1000V AC (35A-800A)
50,000 amperes at 750V DC (35A-800A)

TECHNICAL PARAMETERS/ 技术参数:

CATALOG NO. 目录编号	CURRENT RATING 额定电流	SAFETY APPROVALS 安全认证	
		cURus	
HBE35	35A	○	
HBE40	40A	○	
HBE50	50A	○	
HBE60	60A	○	
HBE70	70A	○	
HBE80	80A	○	
HBE90	90A	○	
HBE100	100A	○	
HBE125	125A	○	
HBE150	150A	○	
HBE175	175A	○	
HBE200	200A	○	
HBE225	225A	○	
HBE250	250A	○	
HBE300	300A	○	
HBE350	350A	○	
HBE400	400A	○	
HBE500	500A	○	
HBE600	600A	○	
HBE650	650A	○	
HBE700	700A	○	
HBE800	800A	○	

● DENOTES FOR APPROVAL
○ DENOTES FOR PENDING

● 表示已取得安全认证
○ 表示正在申请安全认证

Dimensions/ 尺寸:

Unit 单位: mm

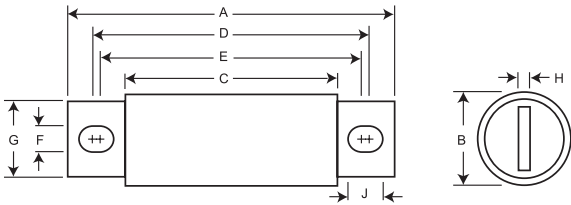

HBE 平均 I-T 曲线图 (仅供参考)

AVERAGE I-T CHARACTERISTICS CURVE
(FOR REFERENCE ONLY)

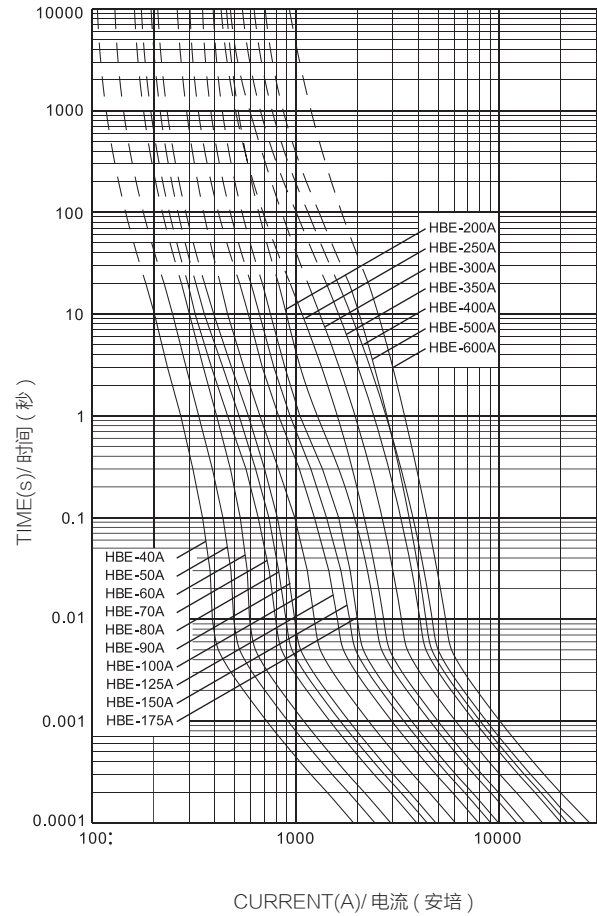

CATALOG NUMBER	A	B	C	D	E	F	G	H	J
HBE35 to 60	125	25.4	87	110	104.6	8.2	18	3.2	10.8
HBE70 to 100	125	31	87	108.6	105	8.6	24	4.8	10.4
HBE125 to 200	143	38	87	121	107.4	10.4	25.4	6.4	17.2
HBE225 to 400	143	50.8	87	123	107.4	10.4	38	6.4	18.2
HBE450 to 800	187	63.5	87	152	120.8	13.5	50	9.5	29.1

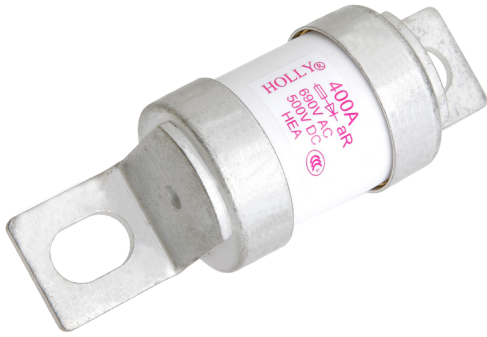

HEA 6A-400A

Class of Operation: aR

保护特性: aR



Standard/ 标准: IEC 60269-4, GB/T 13539.4, UL248-13

INTERRUPTING CAPACITY / 分断能力:

80,000 amperes at 690V AC (6A-400A)

50,000 amperes at 500V DC (6A-400A)

TECHNICAL PARAMETERS/ 技术参数:

CATALOG NO. 目录编号	CURRENT RATING 额定电流	SAFETY APPROVALS 安全认证	
		CCC	cURus
HEA6	6A	●	●
HEA10	10A	●	●
HEA12	12A	●	●
HEA16	16A	●	●
HEA20	20A	●	●
HEA25	25A	●	●
HEA32	32A	●	●
HEA35	35A	●	●
HEA40	40A	●	●
HEA45	45A	●	●
HEA50	50A	●	●
HEA63	63A	●	●
HEA80	80A	●	●
HEA90	90A	●	●
HEA100	100A	●	●
HEA125	125A	●	○
HEA160	160A	●	○
HEA180	180A	●	○
HEA200	200A	●	○
HEA225	225A	●	●
HEA250	250A	●	●
HEA280	280A	●	●
HEA315	315A	●	●
HEA350	350A	●	●
HEA400	400A	●	●

● DENOTES FOR APPROVAL

● 表示已取得安全认证

○ DENOTES FOR PENDING

○ 表示正在申请安全认证

Dimensions/ 尺寸:

Unit 单位: mm

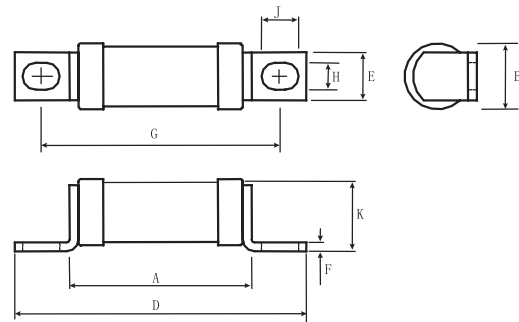

HEA 平均 I-T 曲线图 (仅供参考)

AVERAGE I-T CHARACTERISTICS CURVE
(FOR REFERENCE ONLY)

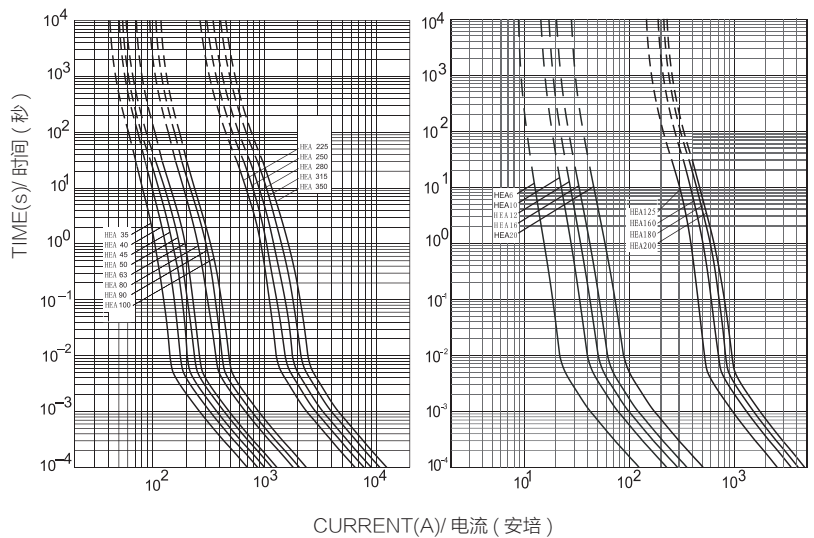

CATALOG NUMBER	A max.	B max.	D max.	E nom.	F max.	G nom.	H nom.	J min.	K max.
6A to 100A	50.6	17.7	79.8	12.7	2.5	63.5	6.4	7.9	19.3
125A to 200A	60	26	95	20	3.3	70	8.7	10.3	28.0
225A to 400A	60	38.2	114	25.4	3.3	85	10.3	13	41.5

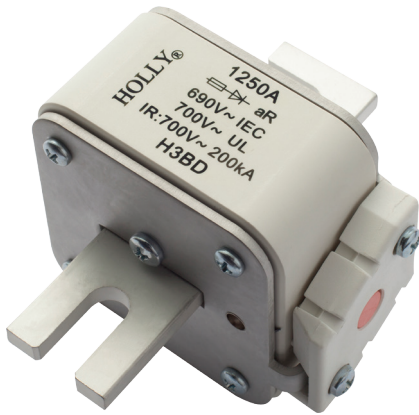

H3BD 500A-1800A

Class of operation: aR
保护特性: aR

Standard/ 标准: IEC 60269-4, GB/T 13539.4, UL248-13

INTERRUPTING CAPACITY/ 分断能力:

200,000 amperes at 690V AC (IEC 500A-1600A)
200,000 amperes at 700V AC (UL 500A-1600A)
200,000 amperes at 600V AC (IEC 1800A)

TECHNICAL PARAMETERS/ 技术参数:

CATALOG NO. 目录编号			额定电流 Rated Current	额定电压 Rated Voltage	功耗 Watts Loss (W)	SAFETY APPROVALS 安全认证
Type-A Type center Indicator for micro	Type-B Type top Indicator for micro	Type-C Visual Indicator				CCC
H3BD500A	H3BD500B	H3BD500C	500A		96	○
H3BD550A	H3BD550B	H3BD550C	550A		100	○
H3BD630A	H3BD630B	H3BD630C	630A		106	○
H3BD700A	H3BD700B	H3BD700C	700A		110	○
H3BD800A	H3BD800B	H3BD800C	800A		116	○
H3BD900A	H3BD900B	H3BD900C	900A	690V AC	120	○
H3BD1000A	H3BD1000B	H3BD1000C	1000A	700V AC	125	○
H3BD1100A	H3BD1100B	H3BD1100C	1100A		130	○
H3BD1250A	H3BD1250B	H3BD1250C	1250A		140	○
H3BD1400A	H3BD1400B	H3BD1400C	1400A		155	○
H3BD1500A	H3BD1500B	H3BD1500C	1500A		160	○
H3BD1600A	H3BD1600B	H3BD1600C	1600A		165	○
H3BD1800A	H3BD1800B	H3BD1800C	1800A	600V AC	170	○

● DENOTES FOR APPROVAL
○ DENOTES FOR PENDING

● 表示已取得安全认证
○ 表示正在申请安全认证

目录编号 Part No.	可选配件 Optional Accessory
H3BD(amp rating)A	微动开关 Microswitches HMC-01
H3BD(amp rating)B	HMT-01

H3BD 平均 I-T 曲线图 (仅供参考)
AVERAGE I-T CHARACTERISTICS CURVE
(FOR REFERENCE ONLY)

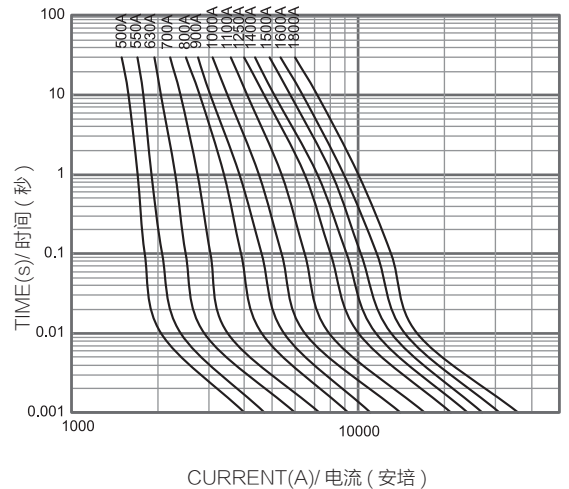

Dimensions/ 尺寸:

Unit 单位: mm

Type-A

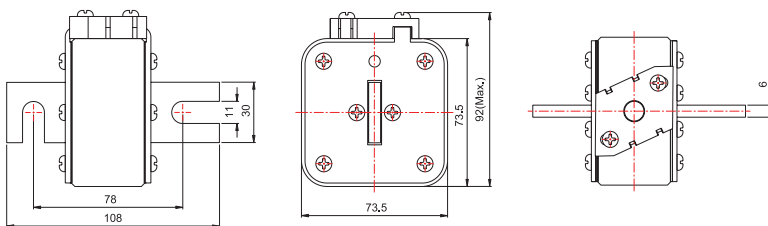

Type-B

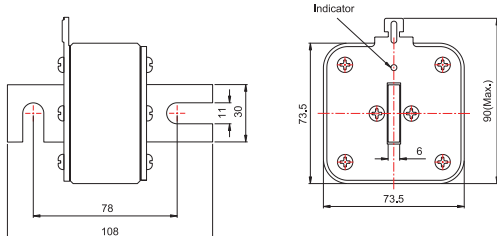

Type-C

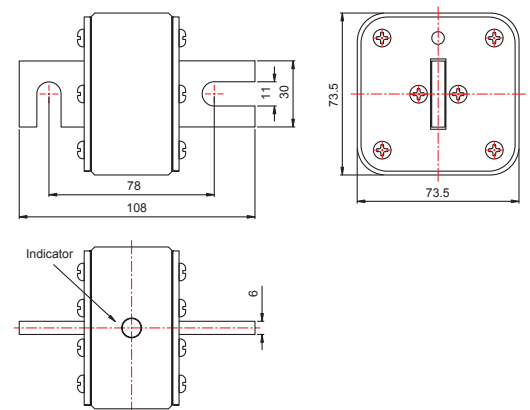



H3BE 315A-1250A

Class of operation: aR
保护特性: aR

Standard/ 标准: IEC 60269-4, GB/T 13539.4, UL248-13

INTERRUPTING CAPACITY/ 分断能力:
150,000 amperes at 1000V AC

TECHNICAL PARAMETERS/ 技术参数:

CATALOG NO. 目录编号			额定电流 Rated Current	额定电压 Rated Voltage	功耗 Watts Loss (W)	SAFETY APPROVALS 安全认证
Type-A Type center Indicator for micro	Type-B Type top Indicator for micro	Type-C Visual Indicator				CCC
H3BE315A	H3BE315B	H3BE315C	315A	1000V AC	91	○
H3BE350A	H3BE350B	H3BE350C	350A		96	○
H3BE400A	H3BE400B	H3BE400C	400A		106	○
H3BE450A	H3BE450B	H3BE450C	450A		110	○
H3BE500A	H3BE500B	H3BE500C	500A		114	○
H3BE550A	H3BE550B	H3BE550C	550A		120	○
H3BE630A	H3BE630B	H3BE630C	630A		126	○
H3BE700A	H3BE700B	H3BE700C	700A		132	○
H3BE800A	H3BE800B	H3BE800C	800A		140	○
H3BE900A	H3BE900B	H3BE900C	900A		150	○
H3BE1000A	H3BE1000B	H3BE1000C	1000A		156	○
H3BE1100A	H3BE1100B	H3BE1100C	1100A		162	○
H3BE1250A	H3BE1250B	H3BE1250C	1250A		176	○

● DENOTES FOR APPROVAL
○ DENOTES FOR PENDING

● 表示已取得安全认证
○ 表示正在申请安全认证

目录编号 Part No.	可选配件 Optional Accessory 微动开关 Microswitches
H3BE(amp rating)A	HMC-01
H3BE(amp rating)B	HMT-01

H3BE 平均 I-T 曲线图 (仅供参考)
AVERAGE I-T CHARACTERISTICS CURVE
(FOR REFERENCE ONLY)

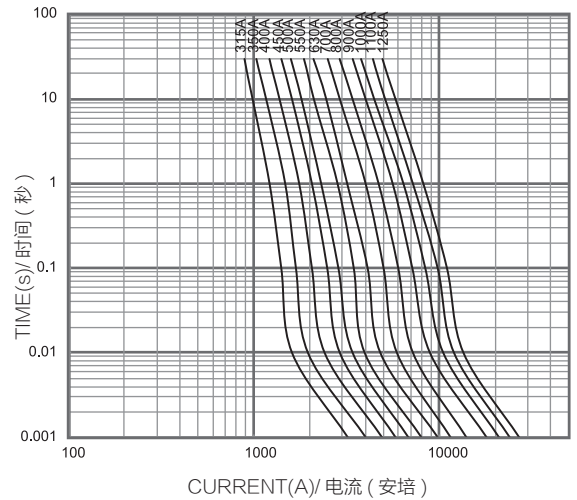

Dimensions/ 尺寸:

Unit 单位: mm

Type-A

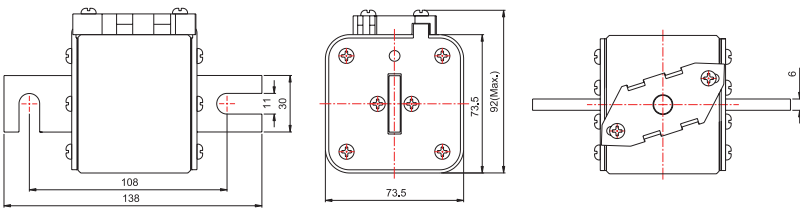

Type-B

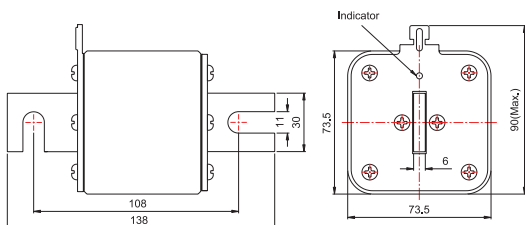

Type-C

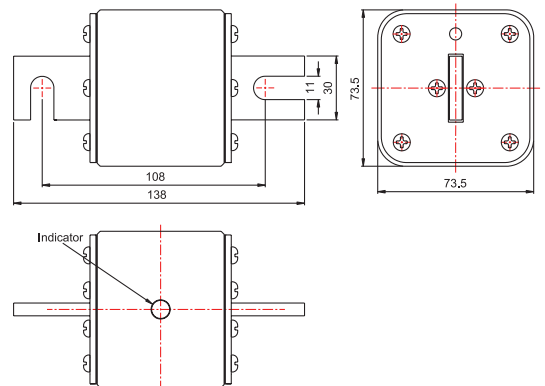



H3BF 315A-1100A

Class of operation: aR
保护特性: aR

Standard/ 标准: IEC 60269-4、GB/T 13539.4、UL248-13

INTERRUPTING CAPACITY/ 分断能力:

100,000 amperes at 1250V AC(IEC) 315A-1100A
100,000 amperes at 1300V AC(UL) 315A-700A

TECHNICAL PARAMETERS/ 技术参数:

CATALOG NO. 目录编号			额定电流 Rated Current	额定电压 Rated Voltage	功耗 Watts Loss (W)	SAFETY APPROVALS 安全认证
Type-A Type center Indicator for micro	Type-B Type top Indicator for micro	Type-C Visual Indicator				CCC
H3BF315A	H3BF315B	H3BF315C	315A	1250V AC	86	○
H3BF350A	H3BF350B	H3BF350C	350A		92	○
H3BF400A	H3BF400B	H3BF400C	400A		96	○
H3BF450A	H3BF450B	H3BF450C	450A		102	○
H3BF500A	H3BF500B	H3BF500C	500A	1300V AC	108	○
H3BF550A	H3BF550B	H3BF550C	550A		112	○
H3BF630A	H3BF630B	H3BF630C	630A	1250V AC	116	○
H3BF700A	H3BF700B	H3BF700C	700A		120	○
H3BF800A	H3BF800B	H3BF800C	800A		125	○
H3BF900A	H3BF900B	H3BF900C	900A		131	○
H3BF1000A	H3BF1000B	H3BF1000C	1000A	1300V AC	136	○
H3BF1100A	H3BF1100B	H3BF1100C	1100A		141	○

● DENOTES FOR APPROVAL ● 表示已取得安全认证
○ DENOTES FOR PENDING ○ 表示正在申请安全认证

目录编号 Part No.	可选配件 Optional Accessory
H3BF(amp rating)A	微动开关 Microswitches HMC-01
H3BF(amp rating)B	HMT-01

H3BF 平均 I-T 曲线图 (仅供参考)
AVERAGE I-T CHARACTERISTICS CURVE
(FOR REFERENCE ONLY)

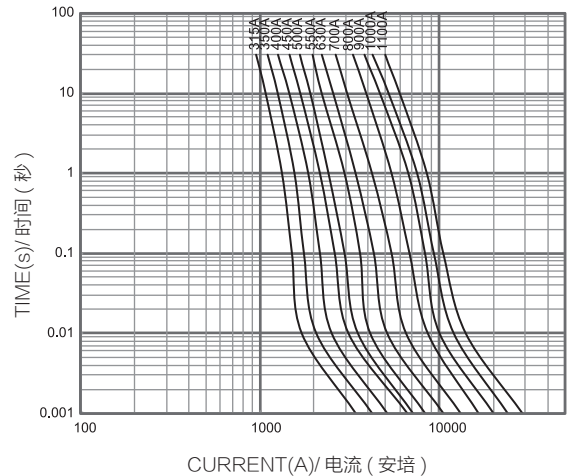

Dimensions/ 尺寸:

Unit unit: mm

Type-A

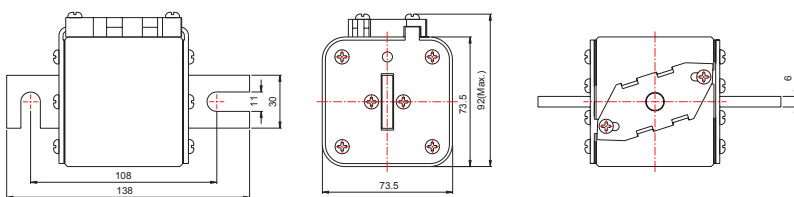

Type-B

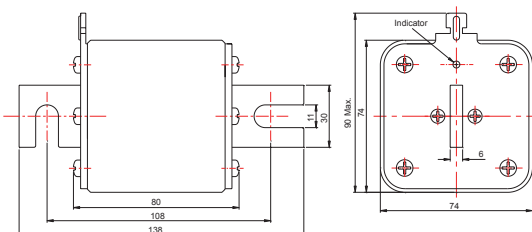

Type-C

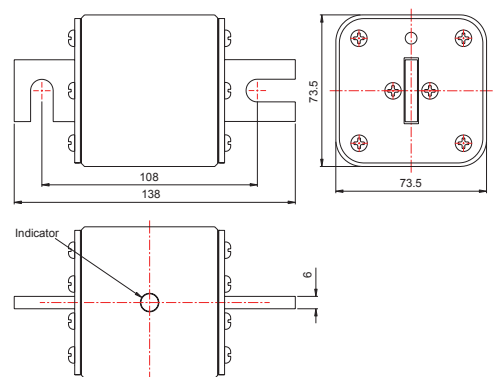



H3FD 500A-1800A

Class of operation: aR
保护特性: aR

Standard/ 标准: IEC 60269-4, GB/T 13539.4, UL248-13

INTERRUPTING CAPACITY/ 分断能力:

200,000 amperes at 690V AC (IEC 500A-1600A)
200,000 amperes at 700V AC (UL 500A-1600A)
200,000 amperes at 600V AC (IEC 1800A)

TECHNICAL PARAMETERS/ 技术参数:

CATALOG NO. 目录编号	额定电流	额定电压	功耗 Watts Loss (W)	SAFETY APPROVALS 安全认证
	Rated Current	Rated Voltage		CCC
H3FD500A	500A		96	○
H3FD550A	550A		100	○
H3FD630A	630A		106	○
H3FD700A	700A		110	○
H3FD800A	800A		116	○
H3FD900A	900A	690V AC 700V AC	120	○
H3FD1000A	1000A		125	○
H3FD1100A	1100A		130	○
H3FD1250A	1250A		140	○
H3FD1400A	1400A		155	○
H3FD1500A	1500A		160	○
H3FD1600A	1600A		165	○
H3FD1800A	1800A	600V AC	170	○

● DENOTES FOR APPROVAL
○ DENOTES FOR PENDING

● 表示已取得安全认证
○ 表示正在申请安全认证

Dimensions/ 尺寸:

Unit 单位: mm

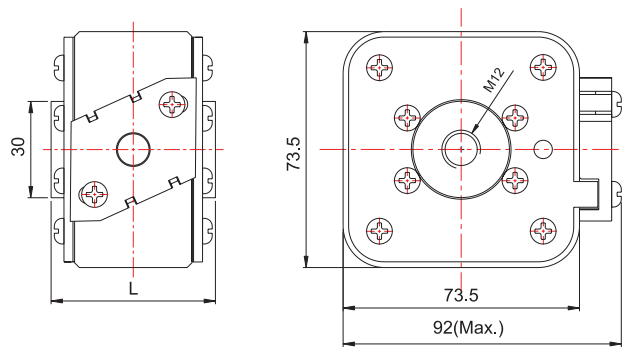

H3FD 平均 I-T 曲线图 (仅供参考)

AVERAGE I-T CHARACTERISTICS CURVE
(FOR REFERENCE ONLY)

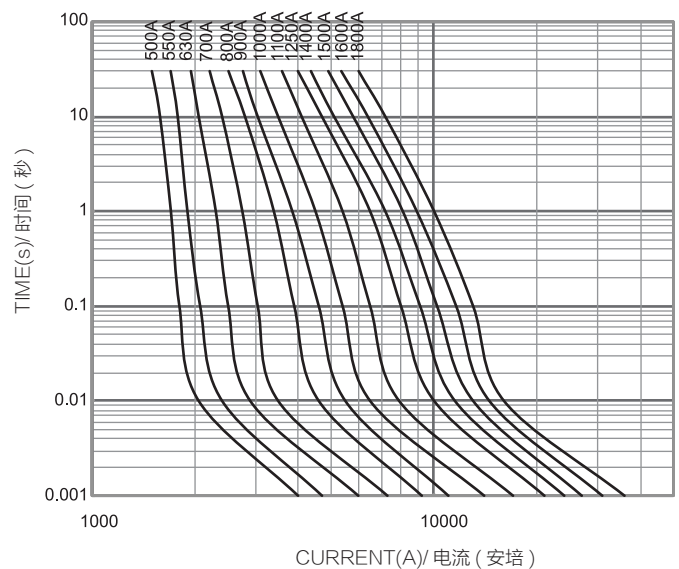

目录编号 Part No.	可选配件 Optional Accessory
	微动开关 Microswitches
H3FD(amp rating)A	HMC-01

目录编号 Part No.	额定电流 Rated Current (A)	L (mm)
H3FD(amp rating)A	500-1500	51
	1600-1800	65



H3FE 315A-1250A

Class of operation: aR
保护特性: aR

Standard/ 标准: IEC 60269-4, GB/T 13539.4, UL248-13

INTERRUPTING CAPACITY/ 分断能力:
150,000 amperes at 1000V AC (315A-1250A)

TECHNICAL PARAMETERS/ 技术参数:

CATALOG NO. 目录编号	额定电流 Rated Current	额定电压 Rated Voltage	功耗 Watts Loss (W)	SAFETY APPROVALS 安全认证
				CCC
H3FE315A	315A		91	○
H3FE350A	350A		96	○
H3FE400A	400A		106	○
H3FE450A	450A		110	○
H3FE500A	500A		114	○
H3FE550A	550A		120	○
H3FE630A	630A	1000V AC	126	○
H3FE700A	700A		132	○
H3FE800A	800A		140	○
H3FE900A	900A		150	○
H3FE1000A	1000A		156	○
H3FE1100A	1100A		162	○
H3FE1250A	1250A		176	○

● DENOTES FOR APPROVAL ● 表示已取得安全认证
○ DENOTES FOR PENDING ○ 表示正在申请安全认证

目录编号 Part No.	可选配件 Optional Accessory
H3FE(amp rating)A	微动开关 Microswitches HMC-01

目录编号 Part No.	额定电流 Rated Current (A)	L (mm)
H3FE(amp rating)A	500-1100	75
	1250	95

Dimensions/ 尺寸:

Unit 单位: mm

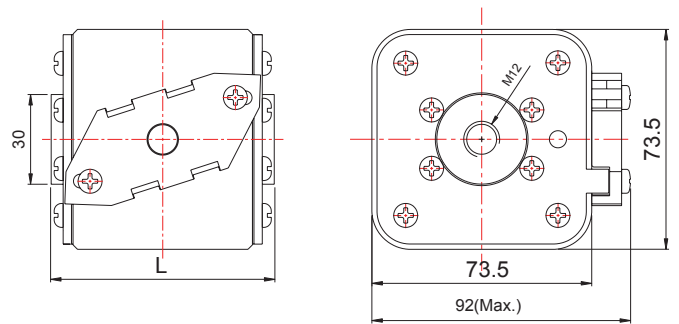

H3FE 平均 I-T 曲线图 (仅供参考) AVERAGE I-T CHARACTERISTICS CURVE (FOR REFERENCE ONLY)

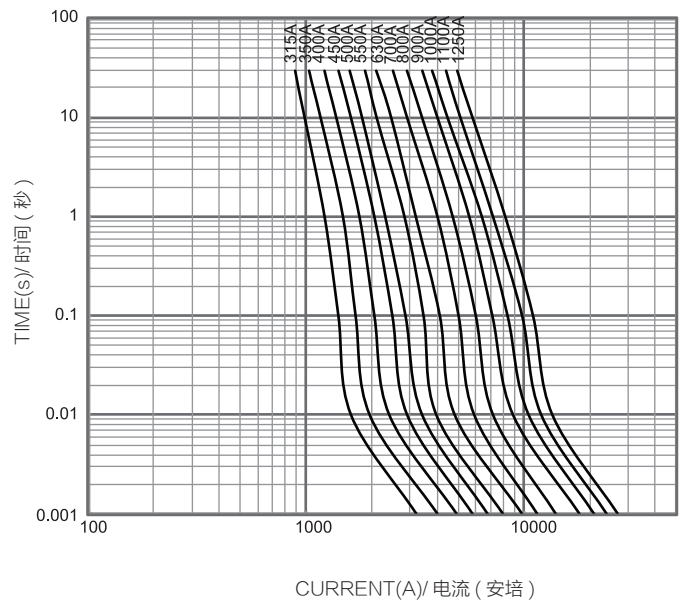



H3FF 315A-1100A

Class of operation: aR
保护特性: aR

Standard/ 标准: IEC 60269-4, GB/T 13539.4, UL248-13

INTERRUPTING CAPACITY/ 分断能力:

100,000 amperes at 1250V AC (IEC 315A-1100A)
100,000 amperes at 1300V AC (UL 315A-800A)

TECHNICAL PARAMETERS/ 技术参数:

CATALOG NO. 目录编号	额定电流 Rated Current	额定电压 Rated Voltage	功耗 Watts Loss (W)	SAFETY APPROVALS 安全认证
Type center Indicator for micro				CCC
H3FF315A	315A		86	○
H3FF350A	350A		92	○
H3FF400A	400A		96	○
H3FF450A	450A		102	○
H3FF500A	500A	1250V AC 1300V AC	108	○
H3FF550A	550A		112	○
H3FF630A	630A		116	○
H3FF700A	700A		120	○
H3FF800A	800A		125	○
H3FF900A	900A		131	○
H3FF1000A	1000A	1250V AC	136	○
H3FF1100A	1100A		141	○

● DENOTES FOR APPROVAL
○ DENOTES FOR PENDING

● 表示已取得安全认证
○ 表示正在申请安全认证

目录编号 Part No.	可选配件 Optional Accessory
	微动开关 Microswitches
H3FF(amp rating)A	HMC-01

目录编号 Part No.	额定电流 Rated Current (A)	L (mm)
H3FF(amp rating)A	315-800	81
	900-1100	95

Dimensions/ 尺寸:

Unit 单位: mm

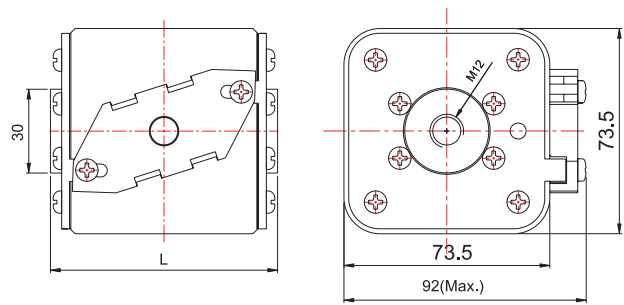

H3FF 平均 I-T 曲线图 (仅供参考)

AVERAGE I-T CHARACTERISTICS CURVE
(FOR REFERENCE ONLY)

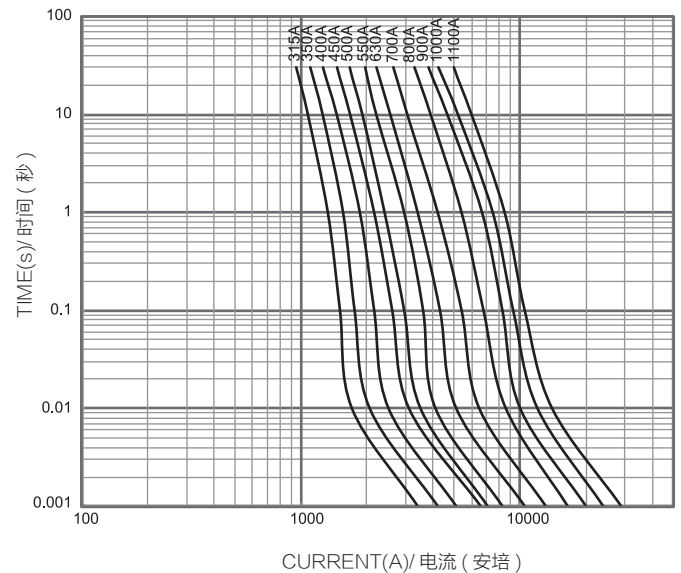

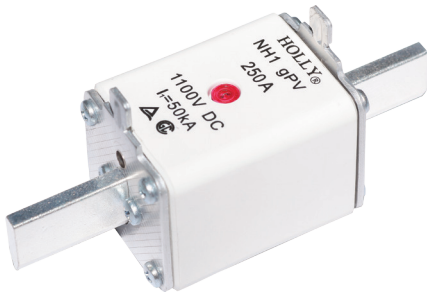

NH1gPV 1100V DC 40A-250A Photovoltaic Fuse 光伏熔断器



Standard/ 标准: IEC 60269-6, GB/T 13539.6

INTERRUPTING CAPACITY 分断能力:

50,000 amperes at 1100V DC (Time Constant:1-3ms)

Dimensions/ 尺寸 (mm)

Type:NH1gPV Part No.: 1gPV(amp rating)U11A/A1/A2

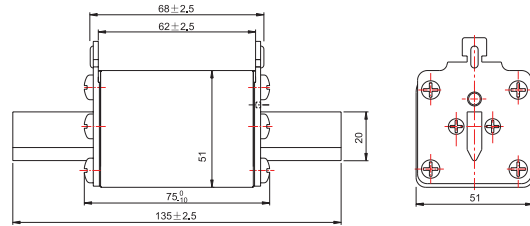

Type:NH1gPV-B Part No.:1gPV(amp rating)U11B

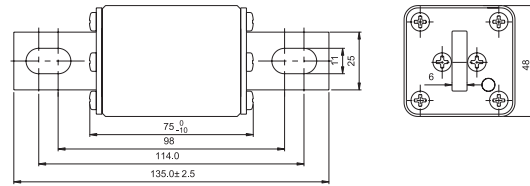

Type:NH1gPV-B Part No.: 1gPV(amp rating)U11BC

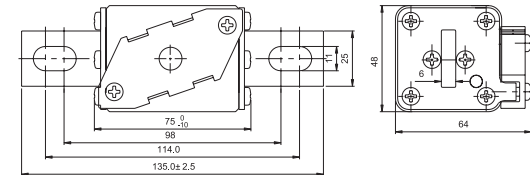

TECHNICAL PARAMETERS/ 技术参数:

CATALOG NO. 目录编号	CURRENT RATING 额定电流	SAFETY APPROVALS 安全认证	
		CGC	TUV
1gPV40U11A/A1/A2	40A	●	●
1gPV40U11B/BC	40A	○	●
1gPV50U11A/A1/A2	50A	●	●
1gPV50U11B/BC	50A	○	●
1gPV63U11A/A1/A2	63A	●	●
1gPV63U11B/BC	63A	○	●
1gPV80U11A/A1/A2	80A	●	●
1gPV80U11B/BC	80A	○	●
1gPV100U11A/A1/A2	100A	●	●
1gPV100U11B/BC	100A	○	●
1gPV125U11A/A1/A2	125A	●	●
1gPV125U11B/BC	125A	○	●
1gPV160U11A/A1/A2	160A	●	●
1gPV160U11B/BC	160A	○	●
1gPV200U11A/A1/A2	200A	●	●
1gPV200U11B/BC	200A	○	●
1gPV225U11A/A1/A2	225A	●	●
1gPV225U11B/BC	225A	○	●
1gPV250U11A/A1/A2	250A	●	●
1gPV250U11B/BC	250A	○	●

- A- 触刀安装带中央指示器 blade contacts with the center indicator
- A1- 触刀安装带顶部指示器 blade contacts with the top indicator
- A2- 触刀安装带中央指示器和顶部指示器 blade contacts with the central indicator and the top indicator
- B- 螺栓连接 bolted connections
- BC- 螺栓连接带微动开关底座 bolted connections with microswitch base
- A、A1、A2-Optional 可选择
- B、BC-Optional 可选择
- U11 DENOTES FOR 1100V DC U11 表示 1100V DC
- DENOTES FOR APPROVAL ● 表示已取得安全认证
- DENOTES FOR PENDING ○ 表示正在申请安全认证

ELECTRICAL CHARACTERISTICS/ 电气特性:

Rating 额定	CONVENTIONAL TIME(H) 约定时间	CONVENTIONAL CURRENT 约定电流	
		CONVENTIONAL NON-FUSING CURRENT(A) 约定不断电流	CONVENTIONAL FUSING CURRENT(A) 约定熔断电流
$I_n \leq 63$	1	$1.13I_n$	$1.45I_n$
$63 < I_n \leq 160$	2	$1.13I_n$	$1.45I_n$
$160 < I_n \leq 250$	3	$1.13I_n$	$1.45I_n$

CATALOG NO. 目录编号	Optional Accessory 可选配件	
	Fuse Holders 熔断器座	Microswitches 微动开关
1gPVXXXU11A	NH1BU11	/
1gPVXXXU11A1/A2	NH1BU11	HMT-01
1gPVXXXU11BC	/	HMC-01

NH1gPV 1100V 平均 I-T 曲线图 (仅供参考)

AVERAGE I-T CHARACTERISTICS CURVE
(FOR REFERENCE ONLY)

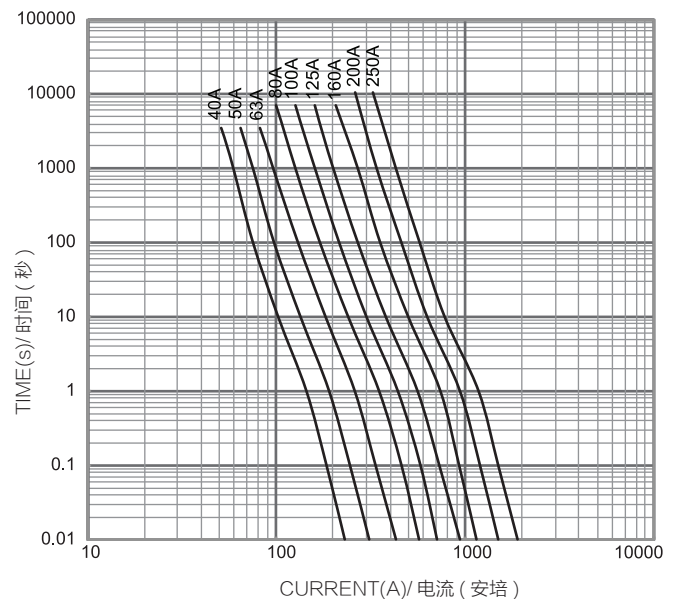



NH1XLgPV 1000V DC 80A-250A Photovoltaic Fuse 光伏熔断器

Standard/ 标准: IEC 60269-6, GB/T 13539.6

INTERRUPTING CAPACITY/ 分断能力:
50,000 amperes at 1000V DC (Time Constant:1-3ms)

Dimensions/ 尺寸:

Unit 单位: mm

Type:NH1XLgPV Part No.: 1XLgPV(amp rating)U0A/A1/A2

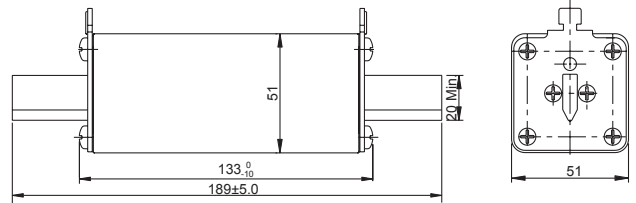

Type:NH1XLgPV-B Part No.: 1XLgPV(amp rating)U0B

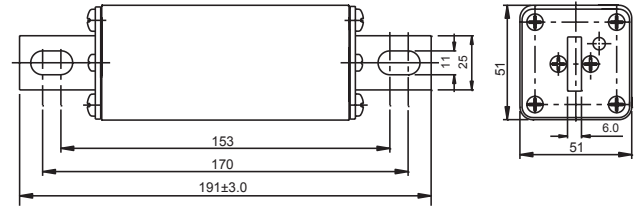

Type:NH1XLgPV-B Part No.: 1XLgPV(amp rating)U0BC

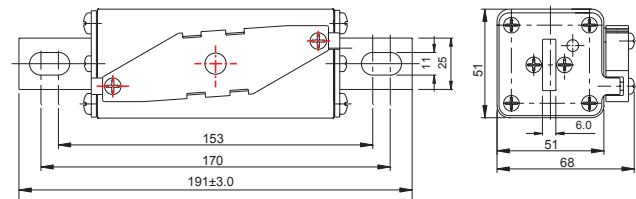

TECHNICAL PARAMETERS/ 技术参数:

CATALOG NO. 目录编号	CURRENT RATING 额定电流	SAFETY APPROVALS 安全认证	
		CGC	TUV
1XLgPV80U0A/A1/A2	80A	○	○
1XLgPV80U0B/BC	80A	○	○
1XLgPV100U0A/A1/A2	100A	○	○
1XLgPV100U0B/BC	100A	○	○
1XLgPV125U0A/A1/A2	125A	○	○
1XLgPV125U0B/BC	125A	○	○
1XLgPV160U0A/A1/A2	160A	○	○
1XLgPV160U0B/BC	160A	○	○
1XLgPV200U0A/A1/A2	200A	○	○
1XLgPV200U0B/BC	200A	○	○
1XLgPV250U0A/A1/A2	250A	○	○
1XLgPV250U0B/BC	250A	○	○

A- 触刀安装带中央指示器 blade contacts with the center indicator
A1- 触刀安装带顶部指示器 blade contacts with the top of the indicator
A2- 触刀安装带中央指示器和顶部指示器 blade contacts with the central indicator and the top of the indicator
B- 螺栓连接 bolted connections
BC- 螺栓连接带微动开关底座 bolted connections with microswitch base
A、A1、A2-optional 可选择
B、BC-optional 可选择

U0 DENOTES FOR 1000V DC U0 表示 1000V DC
● DENOTES FOR APPROVAL ● 表示已取得安全认证
○ DENOTES FOR PENDING ○ 表示正在申请安全认证

CATALOG NO. 目录编号	Optional Accessory 可选配件	
	Fuse Holders 熔断器座	Microswitches 微动开关
1XLgPVXXXU0A	NH1XLBU0	/
1XLgPVXXXU0A1/A2	NH1XLBU0	HMT-01
1XLgPVXXXU0BC	/	HMC-01

NH1XLgPV 平均 I-T 曲线图 (仅供参考)

AVERAGE I-T CHARACTERISTICS CURVE
(FOR REFERENCE ONLY)

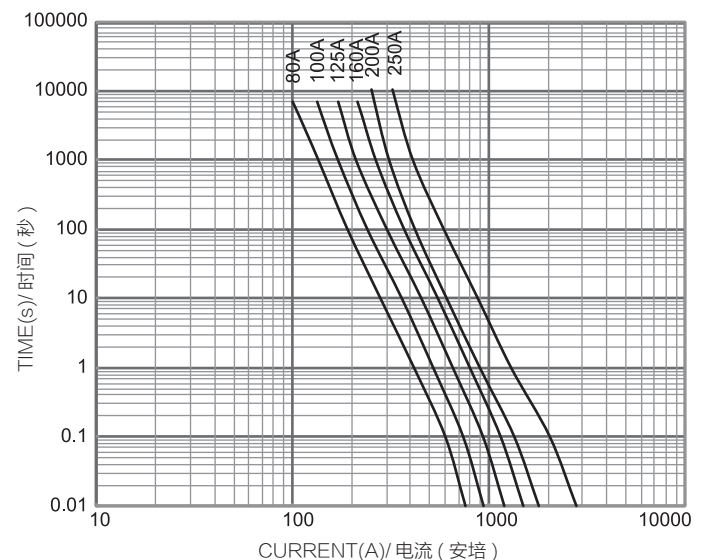



NH2XLgPV 1100V DC 125A-400A Photovoltaic Fuse 光伏熔断器



Standard/ 标准 : IEC 60269-6, GB/T 13539.6

INTERRUPTING CAPACITY / 分断能力 :

30,000 amperes at 1100V DC (Time Constant: 1-3ms)

Dimensions/ 尺寸 (mm)

Type:NH2XLgPV Part No.: 2XLgPV(amp rating)U11A/A1/A2

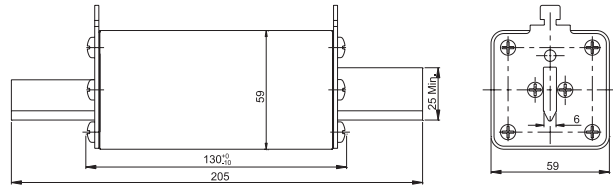

Type:NH2XLgPV-B Part No.: 2XLgPV(amp rating)U11B

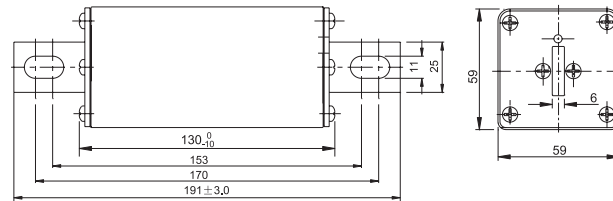

Type:NH2XLgPV-B Part No.: 2XLgPV(amp rating)U11BC

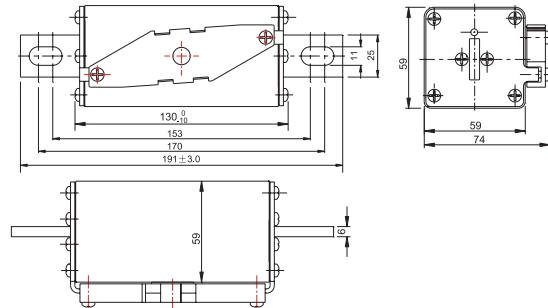

TECHNICAL PARAMETERS/ 技术参数 :

CATALOG NO. 目录编号	CURRENT RATING 额定电流	SAFETY APPROVALS 安全认证	
		CGC	TUV
2XLgPV125U11A/A1/A2	125A	●	●
2XLgPV125U11B/BC	125A	○	●
2XLgPV160U11A/A1/A2	160A	●	●
2XLgPV160U11B/BC	160A	○	●
2XLgPV200U11A/A1/A2	200A	●	●
2XLgPV200U11B/BC	200A	○	●
2XLgPV225U11A/A1/A2	225A	●	●
2XLgPV225U11B/BC	225A	○	●
2XLgPV250U11A/A1/A2	250A	●	●
2XLgPV250U11B/BC	250A	○	●
2XLgPV315U11A/A1/A2	315A	●	●
2XLgPV315U11B/BC	315A	○	●
2XLgPV350U11A/A1/A2	350A	●	●
2XLgPV350U11B/BC	350A	○	●
2XLgPV400U11A/A1/A2	400A	●	●
2XLgPV400U11B/BC	400A	○	●

A- 触刀安装带中央指示器 blade contacts with the center indicator
A1- 触刀安装带顶部指示器 blade contacts with the top indicator
A2- 触刀安装带中央指示器和顶部指示器 blade contacts with the central indicator and the top indicator
B- 螺栓连接 bolted connections
BC- 螺栓连接带微动开关底座 bolted connections with microswitch base
A、A1、A2-optional 可选择
B、BC-optional 可选择

U11 DENOTES FOR 1100V DC U11 表示 1100V DC
● DENOTES FOR APPROVAL ● 表示已取得安全认证
○ DENOTES FOR PENDING ○ 表示正在申请安全认证

CATALOG NO. 目录编号	Optional Accessory 可选配件	
	Fuse Holders 熔断器座	Microswitches 微动开关
2XLgPVXXXU11A	NH3LBU11	/
2XLgPVXXXU11A1/A2	NH3LBU11	HMT-01
2XLgPVXXXU11BC	/	HMC-01

NH2XLgPV 1100V 平均 I-T 曲线图 (仅供参考) AVERAGE I-T CHARACTERISTICS CURVE (FOR REFERENCE ONLY)

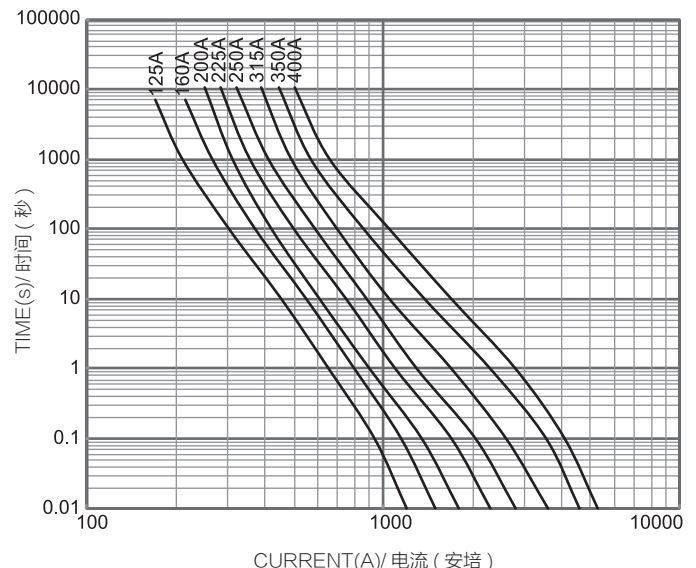



NH3LgPV 1100V DC 315A-630A Photovoltaic Fuse 光伏熔断器

Standard/ 标准: IEC 60269-6, GB/T 13539.6

INTERRUPTING CAPACITY/ 分断能力:
50,000 amperes at 1100V DC (Time Constant:1-3ms)

Dimensions/ 尺寸 (mm)

Type:NH3LgPV Part No.: 3LgPV(amp rating)U11A/A1/A2

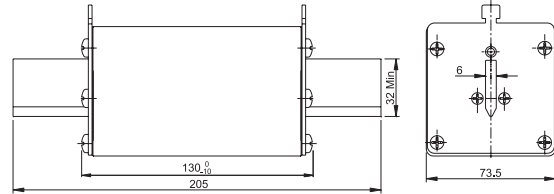

Type:NH3LgPV-B Part No.: 3LgPV(amp rating)U11B

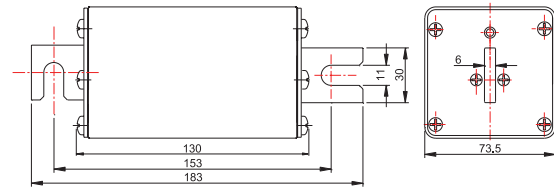

Type:NH3LgPV-B Part No.: 3LgPV(amp rating)U11BC

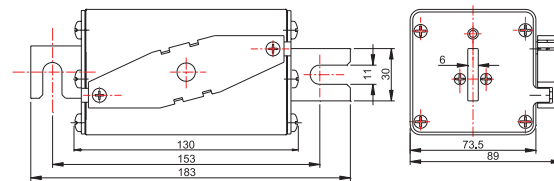

TECHNICAL PARAMETERS/ 技术参数:

CATALOG NO. 目录编号	CURRENT RATING 额定电流	SAFETY APPROVALS 安全认证	
		CGC	TUV
3LgPV315U11A/A1/A2	315A	○	○
3LgPV315U11B/BC	315A	○	○
3LgPV400U11A/A1/A2	400A	○	○
3LgPV400U11B/BC	400A	○	○
3LgPV500U11A/A1/A2	500A	○	○
3LgPV500U11B/BC	500A	○	○
3LgPV630U11A/A1/A2	630A	○	○
3LgPV630U11B/BC	630A	○	○

A- 触刀安装带中央指示器 blade contacts with the center indicator
A1- 触刀安装带顶部指示器 blade contacts with the top indicator
A2- 触刀安装带中央指示器和顶部指示器 blade contacts with the central indicator and the top indicator
B- 螺栓连接 bolted connections
BC- 螺栓连接带微动开关底座 bolted connections with microswitch base
A、A1、A2-optional 可选择
B、BC-optional 可选择

U11 DENOTES FOR 1100V DC U11 表示 1100V DC
● DENOTES FOR APPROVAL ● 表示已取得安全认证
○ DENOTES FOR PENDING ○ 表示正在申请安全认证

ELECTRICAL CHARACTERISTICS/ 电气特性:

Rating 额定	CONVENTIONAL TIME(H) 约定时间	CONVENTIONAL CURRENT 约定电流	
		CONVENTIONAL NON-FUSING CURRENT(A) 约定不熔断电流	CONVENTIONAL FUSING CURRENT(A) 约定熔断电流
160<In ≤ 400	3	1.13In	1.45In
In>400	4	1.13In	1.45In

CATALOG NO. 目录编号	Optional Accessory 可选配件	
	Fuse Holders 熔断器座	Microswitches 微动开关
3LgPVXXXU11A	NH3LB630U11	/
3LgPVXXXU11A1/A2	NH3LB630U11	HMT-01
3LgPVXXXU11BC	/	HMC-01

NH3LgPV 1100V 平均 I-T 曲线图 (仅供参考)

AVERAGE I-T CHARACTERISTICS CURVE
(FOR REFERENCE ONLY)

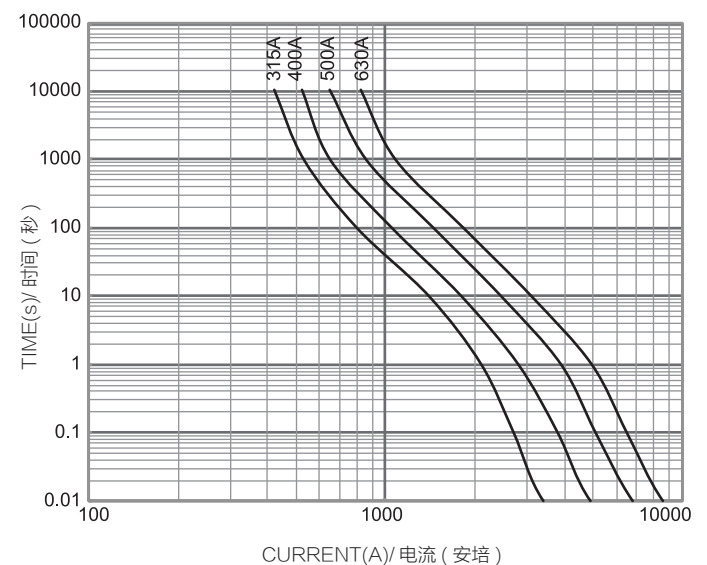



Your Power Safeguard™
您的电路安全卫士



TECHNICAL PARAMETERS/ 技术参数 :

CATALOG NO. 目录编号	CURRENT RATING 额定电流	SAFETY APPROVALS 安全认证	
		CGC	TUV
1XLgPV63U15A/A1/A2	63A	○	○
1XLgPV63U15B/BC		○	○
1XLgPV80U15A/A1/A2		80A	○
1XLgPV80U15B/BC	○		○
1XLgPV100U15A/A1/A2	100A		○
1XLgPV100U15B/BC		○	○
1XLgPV125U15A/A1/A2		125A	○
1XLgPV125U15B/BC	○		○
1XLgPV160U15A/A1/A2	160A		○
1XLgPV160U15B/BC		○	○
1XLgPV200U15A/A1/A2		200A	○
1XLgPV200U15B/BC	○		○

A- 触刀安装带中央指示器 blade contacts with the center indicator
A1- 触刀安装带顶部指示器 blade contacts with the top of the indicator
A2- 触刀安装带中央指示器和顶部指示器 blade contacts with the central indicator and the top of the indicator
B- 螺栓连接 bolted connections
BC- 螺栓连接带微动开关底座 bolted connections with microswitch base
A、A1、A2-optional 可选择
B、BC-optional 可选择

U15 DENOTES FOR 1500V DC U15 表示 1500V DC
● DENOTES FOR APPROVAL ● 表示已取得安全认证
○ DENOTES FOR PENDING ○ 表示正在申请安全认证

CATALOG NO. 目录编号	Optional Accessory 可选配件	
	Fuse Holders 熔断器座	Microswitches 微动开关
1XLgPVXXXU15A	NH1XLBU15	/
1XLgPVXXXU15A1/A2	NH1XLBU15	HMT-01
1XLgPVXXXU15BC	/	HMC-01

NH1XLgPV 1500V DC 63A-200A Photovoltaic Fuse 光伏熔断器

Standard/ 标准: IEC 60269-6, GB/T 13539.6

INTERRUPTING CAPACITY/ 分断能力:
30,000 amperes at 1500V DC (Time Constant:1-3ms)

Dimensions/ 尺寸 :

Unit 单位: mm

Type:NH1XLgPV Part No.: 1XLgPV(amp rating)U15A/A1/A2

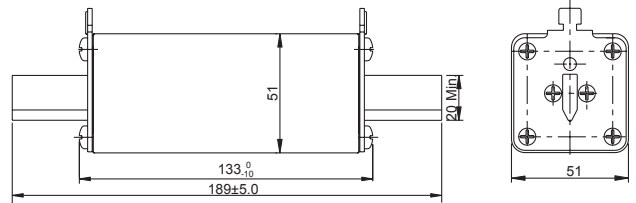

Type:NH1XLgPV-B Part No.: 1XLgPV(amp rating)U15B

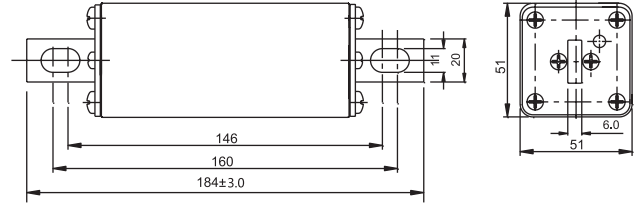

Type:NH1XLgPV-B Part No.: 1XLgPV(amp rating)U15BC

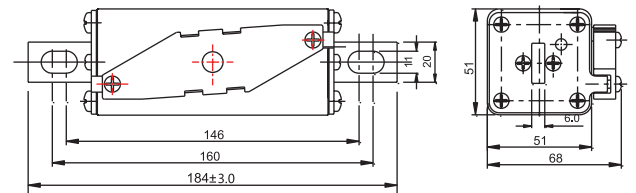

NH1XLgPV 1500V 平均 I-T 曲线图 (仅供参考)
AVERAGE I-T CHARACTERISTICS CURVE
(FOR REFERENCE ONLY)

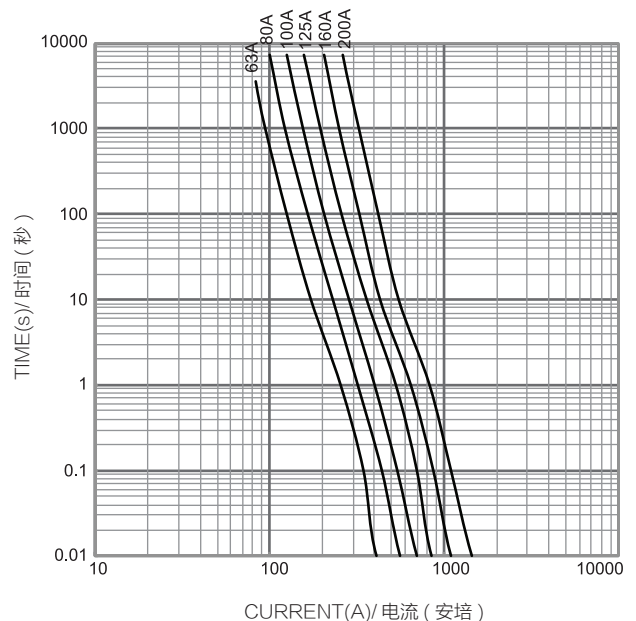



NH2XLgPV 1500V DC 125A-400A Photovoltaic Fuse 光伏熔断器

Standard/ 标准: IEC 60269-6, GB/T 13539.6

INTERRUPTING CAPACITY/ 分断能力:
30,000 amperes at 1500V DC (Time Constant:1-3ms)

Dimensions/ 尺寸 (mm)

Type:NH1XLgPV Part No.: 2XLgPV(amp rating)U15A/A1/A2

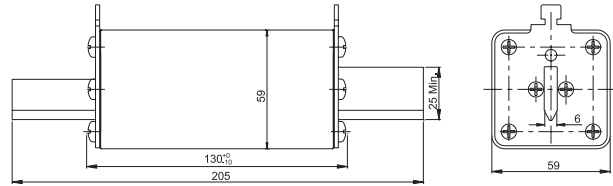

Type:NH2XLgPV-B Part No.: 2gPV(amp rating)U15B

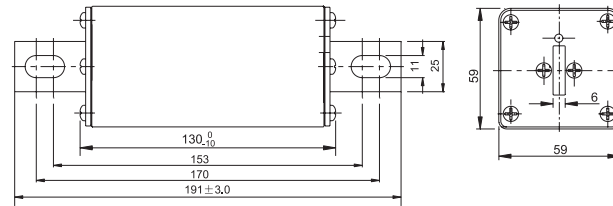

Type:NH2XLgPV-B Part No.: 2gPV(amp rating)U15BC

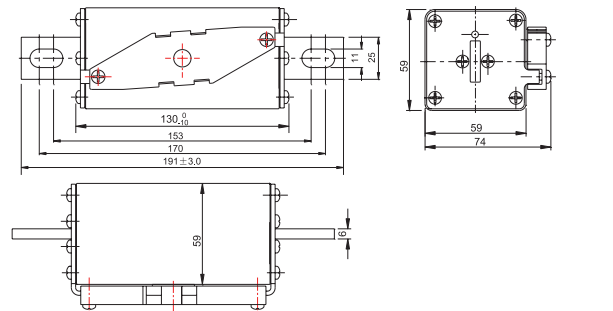

NH2XLgPV 1500V 平均 I-T 曲线图 (仅供参考) AVERAGE I-T CHARACTERISTICS CURVE (FOR REFERENCE ONLY)

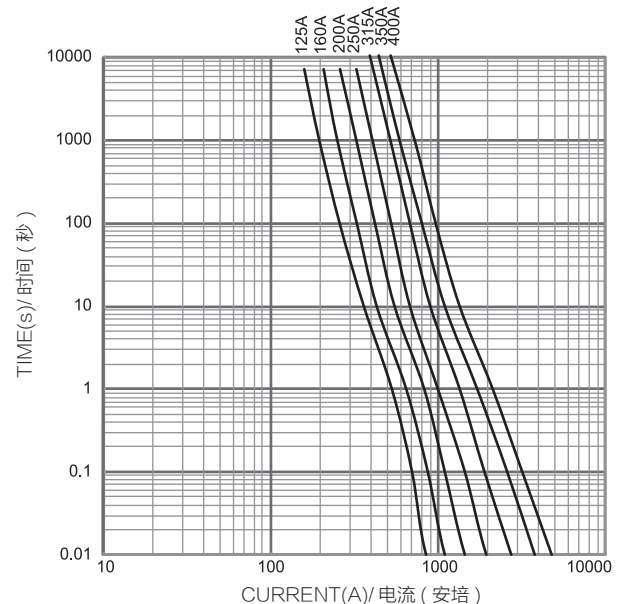

TECHNICAL PARAMETERS/ 技术参数:

CATALOG NO. 目录编号	CURRENT RATING 额定电流	SAFETY APPROVALS 安全认证	
		CGC	TUV
2XLgPV125U15A/A1/A2	125A	○	○
2XLgPV125U15B/BC		○	○
2XLgPV160U15A/A1/A2		160A	○
2XLgPV160U15B/BC	○		○
2XLgPV200U15A/A1/A2	200A		○
2XLgPV200U15B/BC		○	○
2XLgPV250U15A/A1/A2		250A	○
2XLgPV250U15B/BC	○		○
2XLgPV315U15A/A1/A2	315A		○
2XLgPV315U15B/BC		○	○
2XLgPV350U15A/A1/A2		350A	○
2XLgPV350U15B/BC	○		○
2XLgPV400U15A/A1/A2	400A		○
2XLgPV400U15B/BC		○	○

A- 触刀安装带中央指示器 blade contacts with the center indicator
A1- 触刀安装带顶部指示器 blade contacts with the top indicator
A2- 触刀安装带中央指示器和顶部指示器 blade contacts with the central indicator and the top indicator
B- 螺栓连接 bolted connections
BC- 螺栓连接带微动开关底座 bolted connections with microswitch base
A、A1、A2-Optional 可选择
B、BC-Optional 可选择

U15 DENOTES FOR 1500V DC U15 表示 1500V DC
● DENOTES FOR APPROVAL ● 表示已取得安全认证
○ DENOTES FOR PENDING ○ 表示正在申请安全认证

CATALOG NO. 目录编号	Optional Accessory 可选配件	
	Fuse Holders 熔断器座	Microswitches 微动开关
2XLgPVXXU15A	NH3LBU15	/
2XLgPVXXU15A1/A2	NH3LBU15	HMT-01
2XLgPVXXU15BC	/	HMC-01



Your Power Safeguard™
您的电路安全卫士



NH000gG 500V 2A-100A

Class of Operation: gG

保护特性: gG



Standard/ 标准: IEC 60269, GB 13539

INTERRUPTING CAPACITY/ 分断能力:

120,000 amperes at 500V AC(2A-100A)

Dimensions/ 尺寸:

Unit 单位: mm

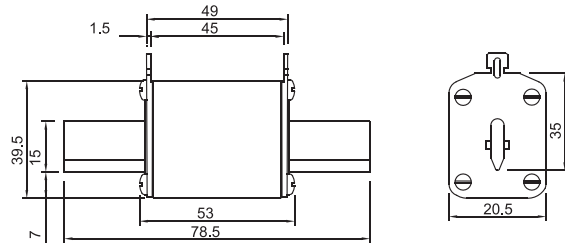

TECHNICAL PARAMETERS/ 技术参数:

CATALOG NO. 目录编号	CURRENT RATING 额定电流	SAFETY APPROVALS 安全认证	
		CCC	
000gG2U5	2A	○	
000gG4U5	4A	○	
000gG6U5	6A	●	
000gG8U5	8A	●	
000gG10U5	10A	●	
000gG12U5	12A	●	
000gG16U5	16A	●	
000gG20U5	20A	●	
000gG25U5	25A	●	
000gG32U5	32A	●	
000gG40U5	40A	●	
000gG50U5	50A	●	
000gG63U5	63A	●	
000gG80U5	80A	●	
000gG100U5	100A	●	

U5 DENOTES FOR 500V AC
● DENOTES FOR APPROVAL
○ DENOTES FOR PENDING

U5 表示 500V AC
● 表示已取得安全认证
○ 表示正在申请安全认证

NH000gG 500V 平均 I-T 曲线图 (仅供参考)

AVERAGE I-T CHARACTERISTICS CURVE
(FOR REFERENCE ONLY)

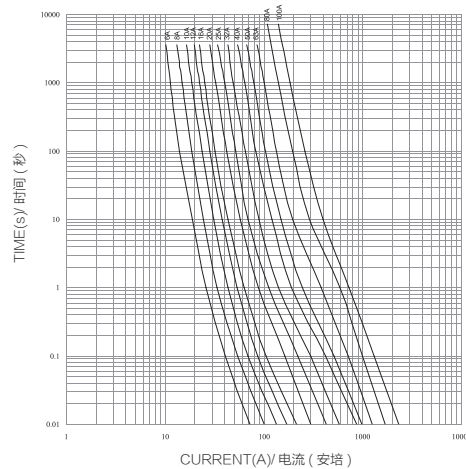

ELECTRICAL CHARACTERISTICS/ 电气特性:

Rated Current In(A) 额定电流 In(A)	CONVENTIONAL TIME(H) 约定时间	CONVENTIONAL CURRENT 约定电流	
		CONVENTIONAL NON-FUSING CURRENT(A) 约定不熔断电流	CONVENTIONAL FUSING CURRENT(A) 约定熔断电流
2A ≤ In ≤ 4A	1h	1.5In	2.1In
6A ≤ In ≤ 12A	1h	1.5In	1.9In
16A ≤ In ≤ 63A	1h	1.25In	1.6In
80A ≤ In ≤ 100A	2h	1.25In	1.6In

Recommended fuse-base for NH000/NH00 fuses

See Model of product: NH00B

适用于 NH000/NH000 熔断体的支持件

详见产品型号: NH00B



NH000gG 500V~ 截断电流曲线图 (仅供参考)

CUT-OFF CHARACTERISTICS CURVE (FOR REFERENCE ONLY)

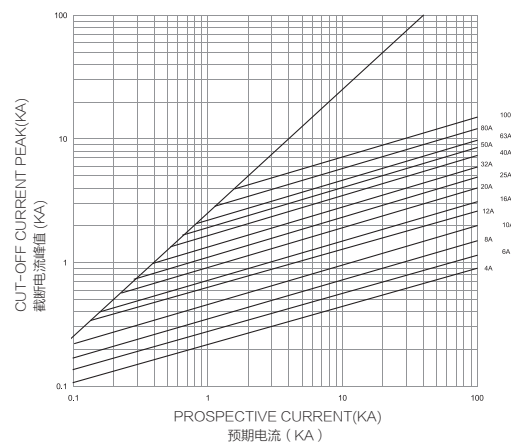



NH00gG 500V/690V 10A-160A

Class of Operation:gG

保护特性: gG



Standard/ 标准: IEC 60269, GB 13539

INTERRUPTING CAPACITY/ 分断能力:

120,000 amperes at 500V AC(10A-160A)
80,000 amperes at 690V AC(10A-100A)

Dimensions/ 尺寸:

Unit 单位: mm

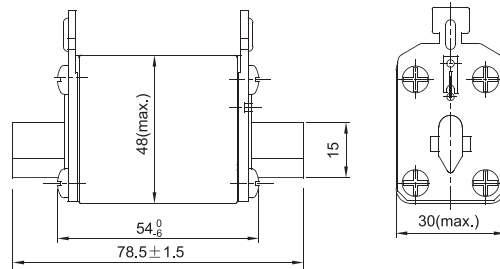

TECHNICAL PARAMETERS/ 技术参数:

CATALOG NO. 目录编号	CURRENT RATING 额定电流	SAFETY APPROVALS 安全认证	
		CCC	
00gG10U5/U6	10A	●	●
00gG12U5/U6	12A	●	●
00gG16U5/U6	16A	●	●
00gG20U5/U6	20A	●	●
00gG25U5/U6	25A	●	●
00gG32U5/U6	32A	●	●
00gG35U5/U6	35A	●	●
00gG40U5/U6	40A	●	●
00gG50U5/U6	50A	●	●
00gG63U5/U6	63A	●	●
00gG80U5/U6	80A	●	●
00gG100U5/U6	100A	●	●
00gG125U5	125A	●	○
00gG160U5	160A	●	○

U5 DENOTES FOR 500V AC
U6 DENOTES FOR 690V AC
● DENOTES FOR APPROVAL
○ DENOTES FOR PENDING

U5 表示 500V AC
U6 表示 690V AC
● 表示已取得安全认证
○ 表示正在申请安全认证

ELECTRICAL CHARACTERISTICS/ 电气特性:

Rated Current In(A) 额定电流 In(A)	CONVENTIONAL TIME(H) 约定时间	CONVENTIONAL CURRENT 约定电流	
		CONVENTIONAL NON-FUSING CURRENT(A) 约定不熔断电流	CONVENTIONAL FUSING CURRENT(A) 约定熔断电流
10A ≤ In ≤ 12A	1h	1.5In	1.9In
16A ≤ In ≤ 63A	1h	1.25In	1.6In
80A ≤ In ≤ 160A	2h	1.25In	1.6In

Recommended fuse-base for NH000/NH00 fuses

See Model of product: NH00B

适用于 NH000/NH00 熔断体的支持件

详见产品型号: NH00B



NH00gG 500V/690V 平均 I-T 曲线图 (仅供参考)
AVERAGE I-T CHARACTERISTICS CURVE
(FOR REFERENCE ONLY)

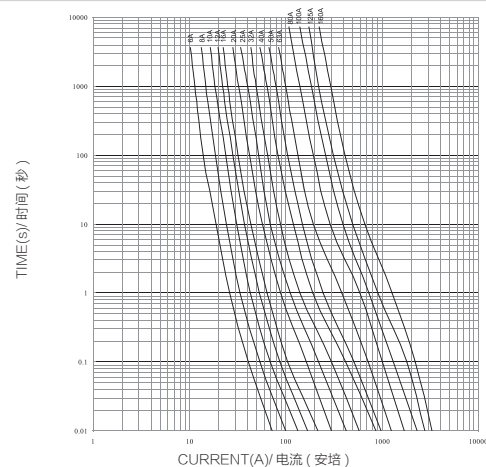

NH00gG 500V/690V~ 截断电流曲线图 (仅供参考)
CUT-OFF CHARACTERISTICS CURVE (FOR REFERENCE ONLY)

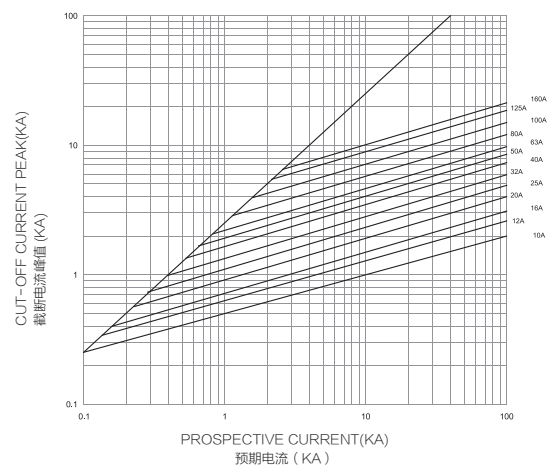

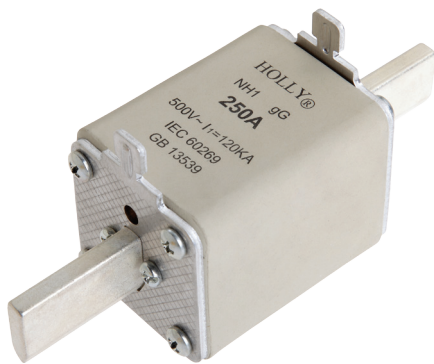

NH1gG 500V 6A-250A

Class of Operation: gG
保护特性: gG

Standard/ 标准: IEC 60269, GB 13539

INTERRUPTING CAPACITY/ 分断能力:
120,000 amperes at 500V AC(6A-250A)

Dimensions/ 尺寸:

Unit 单位: mm

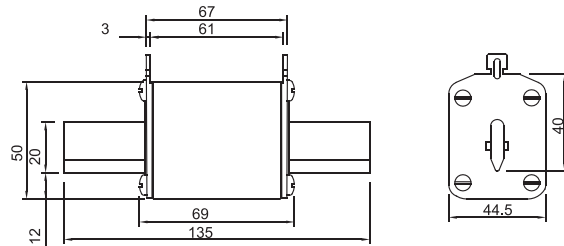

TECHNICAL PARAMETERS/ 技术参数:

CATALOG NO. 目录编号	CURRENT RATING 额定电流	SAFETY APPROVALS 安全认证	
		CCC	
1gG6U5	6A	○	
1gG8U5	8A	○	
1gG10U5	10A	○	
1gG12U5	12A	○	
1gG16U5	16A	○	
1gG20U5	20A	○	
1gG25U5	25A	○	
1gG32U5	32A	○	
1gG40U5	40A	○	
1gG50U5	50A	○	
1gG63U5	63A	○	
1gG80U5	80A	○	
1gG100U5	100A	○	
1gG125U5	125A	○	
1gG160U5	160A	○	
1gG200U5	200A	○	
1gG250U5	250A	○	

U5 DENOTES FOR 500V AC
● DENOTES FOR APPROVAL
○ DENOTES FOR PENDING

U5 表示 500V AC
● 表示已取得安全认证
○ 表示正在申请安全认证

ELECTRICAL CHARACTERISTICS/ 电气特性:

Rated Current In(A) 额定电流 In(A)	CONVENTIONAL TIME(H) 约定时间	CONVENTIONAL CURRENT 约定电流	
		CONVENTIONAL NON-FUSING CURRENT(A) 约定不熔断电流	CONVENTIONAL FUSING CURRENT(A) 约定熔断电流
6A ≤ In ≤ 12A	1h	1.5In	1.9In
16A ≤ In ≤ 63A	1h	1.25In	1.6In
80A ≤ In ≤ 160A	1h	1.25In	1.6In
200A ≤ In ≤ 250A	1h	1.25In	1.6In

Recommended fuse-base for NH1 fuses

See Model of product: NH1B
适用于 NH1 熔断体的支持件
详见产品型号: NH1B



NH1gG 500V 平均 I-T 曲线图 (仅供参考)

AVERAGE I-T CHARACTERISTICS CURVE
(FOR REFERENCE ONLY)

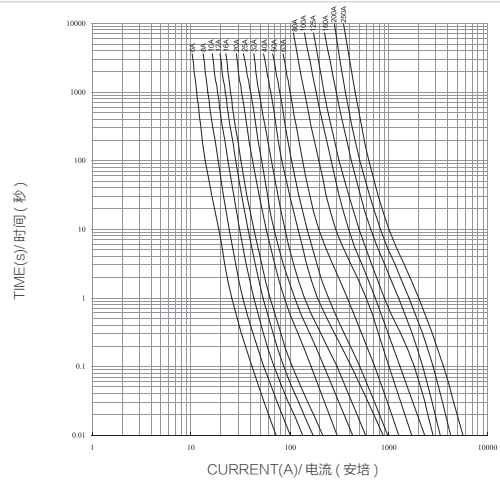

NH1gG 500V~ 截断电流曲线图 (仅供参考)

CUT-OFF CHARACTERISTICS CURVE (FOR REFERENCE ONLY)

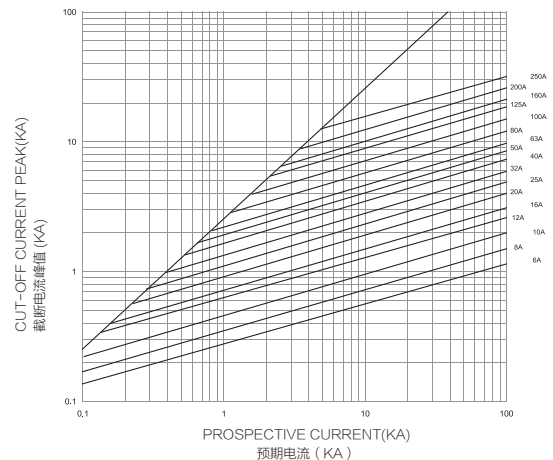

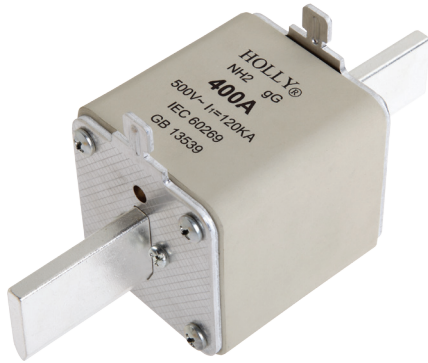

NH2gG 500V 20A-400A

Class of Operation:gG

保护特性: gG

Standard/ 标准: IEC 60269, GB 13539

INTERRUPTING CAPACITY/ 分断能力:
120,000 amperes at 500V AC(20A-400A)

Dimensions/ 尺寸:

Unit 单位: mm

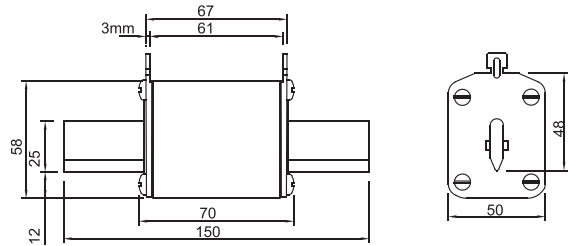

TECHNICAL PARAMETERS/ 技术参数:

CATALOG NO. 目录编号	CURRENT RATING 额定电流	SAFETY APPROVALS 安全认证	
		CCC	
2gG20U5	20A	○	
2gG25U5	25A	○	
2gG32U5	32A	○	
2gG40U5	40A	○	
2gG50U5	50A	○	
2gG63U5	63A	○	
2gG80U5	80A	○	
2gG100U5	100A	○	
2gG125U5	125A	○	
2gG160U5	160A	○	
2gG200U5	200A	○	
2gG250U5	250A	○	
2gG315U5	315A	○	
2gG400U5	400A	○	

U5 DENOTES FOR 500V AC
● DENOTES FOR APPROVAL
○ DENOTES FOR PENDING

U5 表示 500V AC
● 表示已取得安全认证
○ 表示正在申请安全认证

NH2gG 500V 平均 I-T 曲线图 (仅供参考)

AVERAGE I-T CHARACTERISTICS CURVE (FOR REFERENCE ONLY)

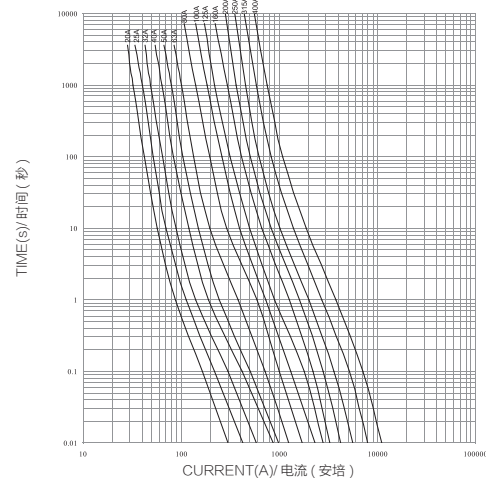

ELECTRICAL CHARACTERISTICS/ 电气特性:

Rated Current In(A) 额定电流 In(A)	CONVENTIONAL TIME(H) 约定时间	CONVENTIONAL CURRENT 约定电流	
		CONVENTIONAL NON-FUSING CURRENT(A) 约定不熔断电流	CONVENTIONAL FUSING CURRENT(A) 约定熔断电流
20A ≤ In ≤ 63A	1h	1.25In	1.9In
80A ≤ In ≤ 160A	2h	1.25In	1.6In
200A ≤ In ≤ 400A	3h	1.25In	1.6In

NH2gG 500V~ 截断电流曲线图 (仅供参考)

CUT-OFF CHARACTERISTICS CURVE (FOR REFERENCE ONLY)

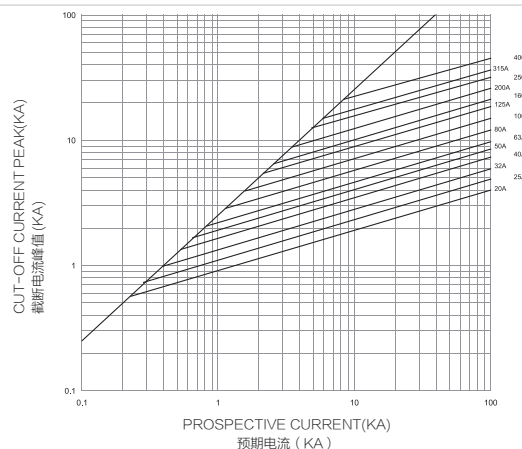

Recommended fuse-base for NH2 fuses

See Model of product: NH2B

适用于 NH2 熔断体的支持件

详见产品型号: NH2B

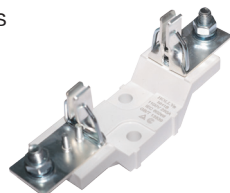



Your Power Safeguard™
您的电路安全卫士



NH3gG 500V 63A-630A

Class of Operation: gG
保护特性: gG

Standard/ 标准: IEC 60269, GB 13539

INTERRUPTING CAPACITY/ 分断能力:

120,000 amperes at 500V AC (63A-630A)

Dimensions/ 尺寸:

Unit 单位: mm

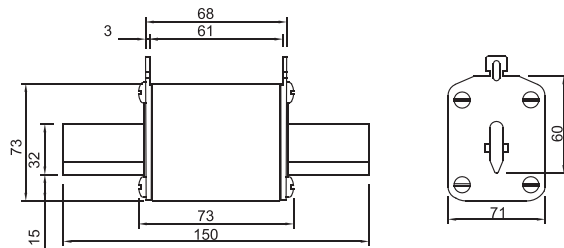

TECHNICAL PARAMETERS/ 技术参数:

CATALOG NO. 目录编号	CURRENT RATING 额定电流	SAFETY APPROVALS 安全认证	
		CCC	
3gG63U5	63A	○	
3gG80U5	80A	○	
3gG100U5	100A	○	
3gG125U5	125A	○	
3gG160U5	160A	○	
3gG200U5	200A	○	
3gG250U5	250A	○	
3gG315U5	315A	○	
3gG400U5	400A	○	
3gG500U5	500A	○	
3gG630U5	630A	○	

U5 DENOTES FOR 500V AC

U5 表示 500V AC

● DENOTES FOR APPROVAL

● 表示已取得安全认证

○ DENOTES FOR PENDING

○ 表示正在申请安全认证

ELECTRICAL CHARACTERISTICS/ 电气特性:

Rated Current In(A) 额定电流 In(A)	CONVENTIONAL TIME(H) 约定时间	CONVENTIONAL CURRENT 约定电流	
		CONVENTIONAL NON-FUSING CURRENT(A) 约定不熔断电流	CONVENTIONAL FUSING CURRENT(A) 约定熔断电流
63A ≤ In ≤ 160A	2h	1.25In	1.6In
200A ≤ In ≤ 400A	3h	1.25In	1.6In
In > 400A	4h	1.25In	1.6In

Recommended fuse-base for NH3 fuses

See Model of product: NH3B

适用于 NH3 熔断体的支持件

详见产品型号: NH3B



NH3gG 500V 平均 I-T 曲线图 (仅供参考)

AVERAGE I-T CHARACTERISTICS CURVE
(FOR REFERENCE ONLY)

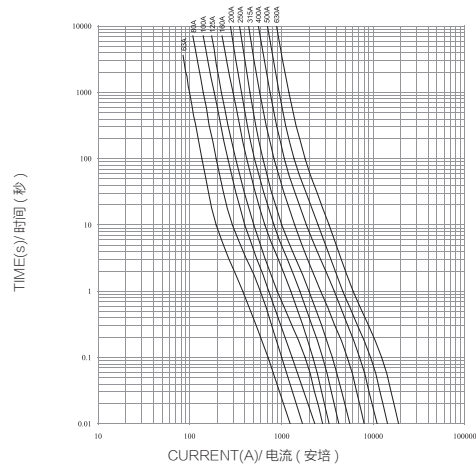

NH3gG 500V~ 截断电流曲线图 (仅供参考)

CUT-OFF CHARACTERISTICS CURVE (FOR REFERENCE ONLY)

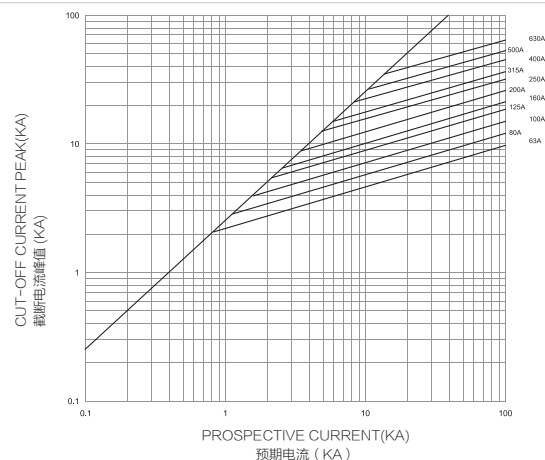



NHgG 400V 2A-630A

Class of Operation:gG

保护特性: gG

Standard/ 标准: IEC 60269, GB 13539

INTERRUPTING CAPACITY/ 分断能力:
120,000 amperes at 400V AC(2A-630A)

Dimensions/ 尺寸:

Unit 单位: mm

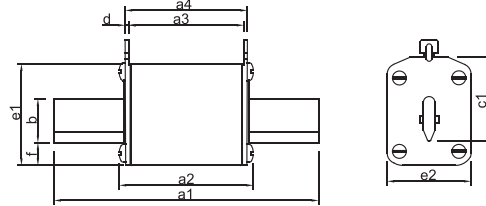

SIZE 尺寸	In (A)	Dimensions in millimetres 尺寸									
		a1	a2	a3	a4	b(min.)	c1	d	e1	e2	f
000	100	78.5	53	45	49	15	35	1.5	39.5	20.5	7
00	160	78.5	53	45	49	15	35	1.5	38	29	7
1	250	135	69	61	67	20	40	3	50	44.5	12
2	400	150	70	61	67	25	48	3	58	50	12
3	630	150	73	61	68	32	60	3	73	71	15

ELECTRICAL CHARACTERISTICS/ 电气特性:

Rated Current In(A) 额定电流 In(A)	CONVENTIONAL TIME(H) 约定时间	CONVENTIONAL CURRENT 约定电流	
		CONVENTIONAL NON-FUSING CURRENT(A) 约定不熔断电流	CONVENTIONAL FUSING CURRENT(A) 约定熔断电流
2A ≤ In ≤ 4A	1h	1.5In	2.1In
6A ≤ In ≤ 12A	1h	1.5In	1.9In
16A ≤ In ≤ 63A	1h	1.25In	1.6In
80A ≤ In ≤ 160A	2h	1.25In	1.6In
200A ≤ In ≤ 400A	3h	1.25In	1.6In
In > 400A	4h	1.25In	1.6In

NHgG 400V 平均 I-T 曲线图 (仅供参考)

AVERAGE I-T CHARACTERISTICS CURVE
(FOR REFERENCE ONLY)

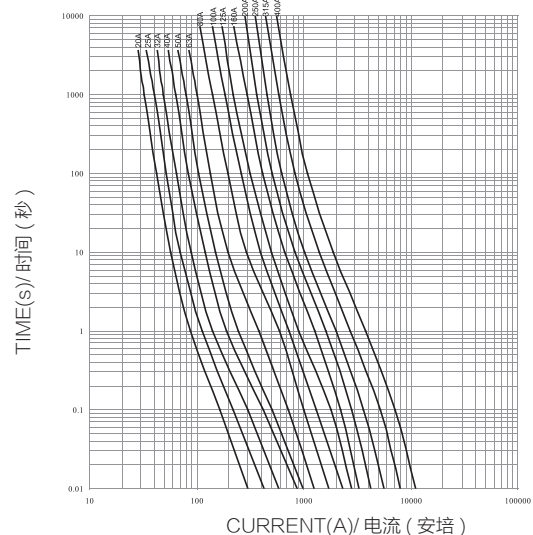

TECHNICAL PARAMETERS/ 技术参数:

CATALOG NO. 目录编号	CURRENT RATING 额定电流	SAFETY APPROVALS 安全认证	
		CCC	
000gG2U4	2A	○	
000gG4U4	4A	○	
000gG6U4	6A	○	
000gG8U4	8A	○	
000gG10U4	10A	○	
000gG12U4	12A	○	
000gG16U4	16A	○	
000gG20U4	20A	○	
000gG25U4	25A	○	
000gG32U4	32A	○	
000gG40U4	40A	○	
000gG50U4	50A	○	
000gG63U4	63A	○	
000gG80U4	80A	○	
000gG100U4	100A	○	
00gG10U4	10A	○	
00gG12U4	12A	○	
00gG16U4	16A	○	
00gG20U4	20A	○	
00gG25U4	25A	○	
00gG32U4	32A	○	
00gG40U4	40A	○	
00gG50U4	50A	○	
00gG63U4	63A	○	
00gG80U4	80A	○	
00gG100U4	100A	○	
00gG125U4	125A	○	
00gG160U4	160A	○	
1gG20U4	20A	○	
1gG25U4	25A	○	
1gG32U4	32A	○	
1gG40U4	40A	○	
1gG50U4	50A	○	
1gG63U4	63A	○	
1gG80U4	80A	○	
1gG100U4	100A	○	
1gG125U4	125A	○	
1gG160U4	160A	○	
1gG200U4	200A	○	
1gG250U4	250A	○	
2gG40U4	40A	○	
2gG50U4	50A	○	
2gG63U4	63A	○	
2gG80U4	80A	○	
2gG100U4	100A	○	
2gG125U4	125A	○	
2gG160U4	160A	○	
2gG200U4	200A	○	
2gG250U4	250A	○	
2gG315U4	315A	○	
2gG400U4	400A	○	
3gG63U4	63A	○	
3gG80U4	80A	○	
3gG100U4	100A	○	
3gG125U4	125A	○	
3gG160U4	160A	○	
3gG200U4	200A	○	
3gG250U4	250A	○	
3gG315U4	315A	○	
3gG400U4	400A	○	
3gG500U4	500A	○	
3gG630U4	630A	○	

U4 DENOTES FOR 400V AC
● DENOTES FOR APPROVAL
○ DENOTES FOR PENDING

U4 表示 400V AC
● 表示已取得安全认证
○ 表示正在申请安全认证



Your Power Safeguard™
您的电路安全卫士

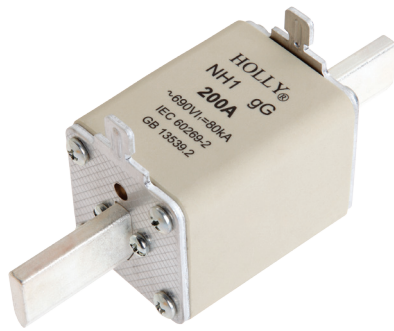

TECHNICAL PARAMETERS/ 技术参数:

CATALOG NO. 目录编号	CURRENT RATING 额定电流	SAFETY APPROVALS 安全认证	
		CCC	
000g2U6	2A	○	○
000g4U6	4A	○	○
000g6U6	6A	○	○
000g8U6	8A	○	○
000g10U6	10A	○	○
000g12U6	12A	○	○
000g16U6	16A	○	○
000g20U6	20A	○	○
000g25U6	25A	○	○
000g32U6	32A	○	○
000g40U6	40A	○	○
000g50U6	50A	○	○
000g63U6	63A	○	○
00g6U6	6A	○	○
00g8U6	8A	○	○
00g10U6	10A	○	○
00g12U6	12A	○	○
00g16U6	16A	○	○
00g20U6	20A	○	○
00g25U6	25A	○	○
00g32U6	32A	○	○
00g40U6	40A	○	○
00g50U6	50A	○	○
00g63U6	63A	○	○
00g80U6	80A	○	○
00g100U6	100A	○	○
1g6U6	6A	○	○
1g8U6	8A	○	○
1g10U6	10A	○	○
1g12U6	12A	○	○
1g16U6	16A	○	○
1g20U6	20A	○	○
1g25U6	25A	○	○
1g32U6	32A	○	○
1g40U6	40A	○	○
1g50U6	50A	○	○
1g63U6	63A	○	○
1g80U6	80A	○	○
1g100U6	100A	○	○
1g125U6	125A	○	○
1g160U6	160A	○	○
1g200U6	200A	○	○
2g16U6	16A	○	○
2g20U6	20A	○	○
2g25U6	25A	○	○
2g32U6	32A	○	○
2g40U6	40A	○	○
2g50U6	50A	○	○
2g63U6	63A	○	○
2g80U6	80A	○	○
2g100U6	100A	○	○
2g125U6	125A	○	○
2g160U6	160A	○	○
2g200U6	200A	○	○
2g250U6	250A	○	○
2g315U6	315A	○	○
3g80U6	80A	○	○
3g100U6	100A	○	○
3g125U6	125A	○	○
3g160U6	160A	○	○
3g200U6	200A	○	○
3g250U6	250A	○	○
3g315U6	315A	○	○
3g400U6	400A	○	○
3g500U6	500A	○	○

U6 DENOTES FOR 690V AC
● DENOTES FOR APPROVAL
○ DENOTES FOR PENDING

U6 表示 690V AC
● 表示已取得安全认证
○ 表示正在申请安全认证

NHgG 690V 2A-500A

Class of Operation: gG

保护特性: gG

Standard/ 标准: IEC 60269, GB 13539

INTERRUPTING CAPACITY/ 分断能力:
120,000 amperes at 690V AC(2A-500A)

Dimensions/ 尺寸:

Unit 单位: mm

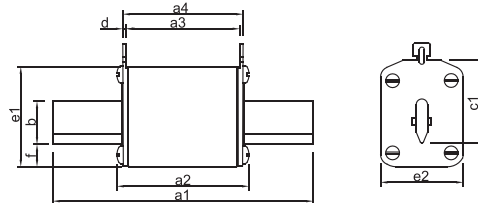

SIZE 尺寸	In (A)	Dimensions in millimetres 尺寸									
		a1	a2	a3	a4	b(min.)	c1	d	e1	e2	f
000	100	78.5	53	45	49	15	35	1.5	39.5	20.5	7
00	160	78.5	53	45	49	15	35	1.5	38	29	7
1	250	135	69	61	67	20	40	3	50	44.5	12
2	400	150	70	61	67	25	48	3	58	50	12
3	630	150	73	61	68	32	60	3	73	71	15

ELECTRICAL CHARACTERISTICS/ 电气特性:

Rated Current In(A) 额定电流 In(A)	CONVENTIONAL TIME(H) 约定时间	CONVENTIONAL CURRENT 约定电流	
		CONVENTIONAL NON-FUSING CURRENT(A) 约定不熔断电流	CONVENTIONAL FUSING CURRENT(A) 约定熔断电流
2A ≤ In ≤ 4A	1h	1.5In	2.1In
6A ≤ In ≤ 12A	1h	1.5In	1.9In
16A ≤ In ≤ 63A	1h	1.25In	1.6In
80A ≤ In ≤ 160A	2h	1.25In	1.6In
200A ≤ In ≤ 400A	3h	1.25In	1.6In
In > 400A	4h	1.25In	1.6In

NHgG 690V

AVERAGE I-T CHARACTERISTICS CURVE(FOR REFERENCE ONLY) 平均 I-T 曲线图 (仅供参考)

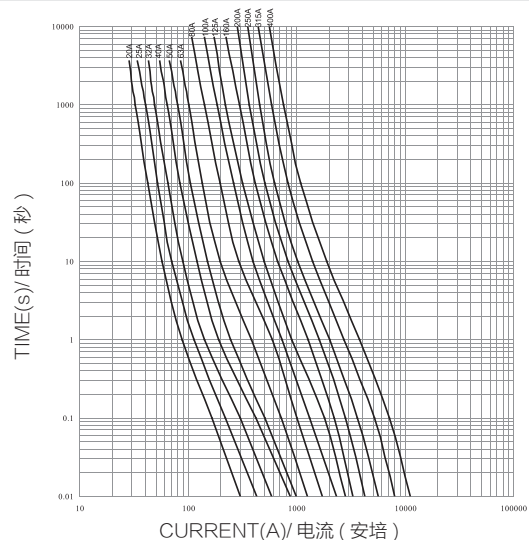



NHaM 500V 2A-630A

Class of Operation: aM

保护特性: aM

Standard/ 标准: IEC 60269, GB 13539

INTERRUPTING CAPACITY/ 分断能力:
120,000 amperes at 500V AC(2A-630A)

TECHNICAL PARAMETERS/ 技术参数:

CATALOG NO. 目录编号	CURRENT RATING 额定电流	SAFETY APPROVALS 安全认证	
		CCC	
000aM2U5	2A	○	
000aM4U5	4A	○	
000aM6U5	6A	○	
000aM8U5	8A	○	
000aM10U5	10A	○	
000aM12U5	12A	○	
000aM16U5	16A	○	
000aM20U5	20A	○	
000aM25U5	25A	○	
000aM32U5	32A	○	
000aM40U5	40A	○	
000aM50U5	50A	○	
000aM63U5	63A	○	
000aM80U5	80A	○	
000aM100U5	100A	○	
00aM10U5	10A	○	
00aM12U5	12A	○	
00aM16U5	16A	○	
00aM20U5	20A	○	
00aM25U5	25A	○	
00aM32U5	32A	○	
00aM40U5	40A	○	
00aM50U5	50A	○	
00aM63U5	63A	○	
00aM80U5	80A	○	
00aM100U5	100A	○	
00aM125U5	125A	○	
00aM160U5	160A	○	
1aM6U5	6A	○	
1aM8U5	8A	○	
1aM10U5	10A	○	
1aM12U5	12A	○	
1aM16U5	16A	○	
1aM20U5	20A	○	
1aM25U5	25A	○	
1aM32U5	32A	○	
1aM40U5	40A	○	
1aM50U5	50A	○	
1aM63U5	63A	○	
1aM80U5	80A	○	
1aM100U5	100A	○	
1aM125U5	125A	○	
1aM160U5	160A	○	
1aM200U5	200A	○	
1aM250U5	250A	○	
2aM20U5	20A	○	
2aM25U5	25A	○	
2aM32U5	32A	○	
2aM40U5	40A	○	
2aM50U5	50A	○	
2aM63U5	63A	○	
2aM80U5	80A	○	
2aM100U5	100A	○	
2aM125U5	125A	○	
2aM160U5	160A	○	
2aM200U5	200A	○	
2aM250U5	250A	○	
2aM315U5	315A	○	
2aM400U5	400A	○	
3aM125U5	125A	○	
3aM160U5	160A	○	
3aM200U5	200A	○	
3aM250U5	250A	○	
3aM315U5	315A	○	
3aM400U5	400A	○	
3aM500U5	500A	○	
3aM630U5	630A	○	

Dimensions/ 尺寸:

Unit 单位: mm

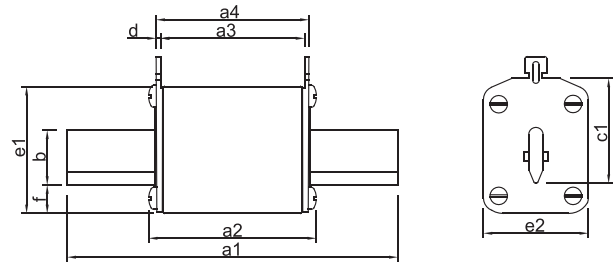

SIZE 尺寸	In (A)	Dimensions in millimetres 尺寸									
		a1	a2	a3	a4	b(min.)	c1	d	e1	e2	f
000	100	78.5	53	45	49	15	35	1.5	39.5	20.5	7
00	160	78.5	53	45	49	15	35	1.5	38	29	7
1	250	135	69	61	67	20	40	3	50	44.5	12
2	400	150	70	61	67	25	48	3	58	50	12
3	630	150	73	61	68	32	60	3	73	71	15

ELECTRICAL CHARACTERISTICS/ 电气特性:

	4In	6.3In	8In	10In	12.5In	19In
t 熔断 Operating	—	60s	—	—	0.5s	0.1s
t 弧前 Pre-arcing	60s	—	0.5s	0.2s	—	—

NHaM 500V 平均 I-T 曲线图 (仅供参考)

AVERAGE I-T CHARACTERISTICS CURVE (FOR REFERENCE ONLY)

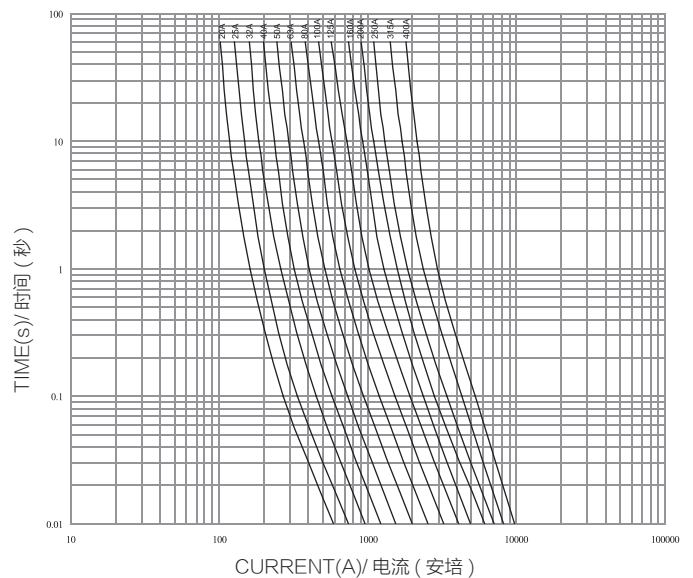

U5 DENOTES FOR 500V AC
● DENOTES FOR APPROVAL
○ DENOTES FOR PENDING

U5 表示 500V AC
● 表示已取得安全认证
○ 表示正在申请安全认证



Your Power Safeguard™
您的电路安全卫士



NHaM 690V 2A-630A

Class of Operation: aM
保护特性: aM

Standard/ 标准: IEC 60269, GB 13539

INTERRUPTING CAPACITY/ 分断能力:
120,000 amperes at 690V AC (2A-630A)

TECHNICAL PARAMETERS/ 技术参数:

CATALOG NO. 目录编号	CURRENT RATING 额定电流	SAFETY APPROVALS 安全认证	
		CCC	
000aM2U6	2A	○	○
000aM4U6	4A	○	○
000aM6U6	6A	○	○
000aM8U6	8A	○	○
000aM10U6	10A	○	○
000aM12U6	12A	○	○
000aM16U6	16A	○	○
000aM20U6	20A	○	○
000aM25U6	25A	○	○
000aM32U6	32A	○	○
000aM40U6	40A	○	○
000aM50U6	50A	○	○
000aM63U6	63A	○	○
000aM80U6	80A	○	○
00aM6U6	6A	○	○
00aM8U6	8A	○	○
00aM10U6	10A	○	○
00aM12U6	12A	○	○
00aM16U6	16A	○	○
00aM20U6	20A	○	○
00aM25U6	25A	○	○
00aM32U6	32A	○	○
00aM40U6	40A	○	○
00aM50U6	50A	○	○
00aM63U6	63A	○	○
00aM80U6	80A	○	○
00aM100U6	100A	○	○
1aM6U6	6A	○	○
1aM8U6	8A	○	○
1aM10U6	10A	○	○
1aM12U6	12A	○	○
1aM16U6	16A	○	○
1aM20U6	20A	○	○
1aM25U6	25A	○	○
1aM32U6	32A	○	○
1aM40U6	40A	○	○
1aM50U6	50A	○	○
1aM63U6	63A	○	○
1aM80U6	80A	○	○
1aM100U6	100A	○	○
1aM125U6	125A	○	○
1aM160U6	160A	○	○
1aM200U6	200A	○	○
1aM250U6	250A	○	○
2aM16U6	16A	○	○
2aM20U6	20A	○	○
2aM25U6	25A	○	○
2aM32U6	32A	○	○
2aM40U6	40A	○	○
2aM50U6	50A	○	○
2aM63U6	63A	○	○
2aM80U6	80A	○	○
2aM100U6	100A	○	○
2aM125U6	125A	○	○
2aM160U6	160A	○	○
2aM200U6	200A	○	○
2aM250U6	250A	○	○
2aM315U6	315A	○	○
2aM400U6	400A	○	○
3aM80U6	80A	○	○
3aM100U6	100A	○	○
3aM125U6	125A	○	○
3aM160U6	160A	○	○
3aM200U6	200A	○	○
3aM250U6	250A	○	○
3aM315U6	315A	○	○
3aM400U6	400A	○	○
3aM500U6	500A	○	○
3aM600U6	600A	○	○

Dimensions/ 尺寸:

Unit 单位: mm

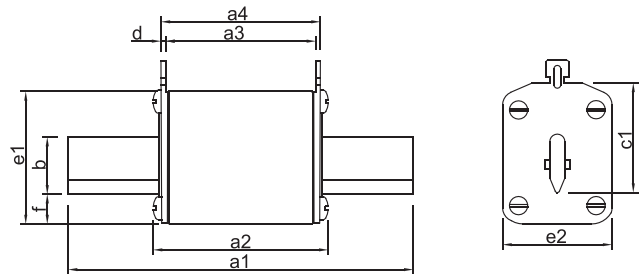

SIZE 尺寸	In (A)	Dimensions in millimetres 尺寸									
		a1	a2	a3	a4	b(min.)	c1	d	e1	e2	f
000	100	78.5	53	45	49	15	35	1.5	39.5	20.5	7
00	160	78.5	53	45	49	15	35	1.5	38	29	7
1	250	135	69	61	67	20	40	3	50	44.5	12
2	400	150	70	61	67	25	48	3	58	50	12
3	630	150	73	61	68	32	60	3	73	71	15

ELECTRICAL CHARACTERISTICS/ 电气特性:

	4In	6.3In	8In	10In	12.5In	19In
t 熔断 Operating	—	60s	—	—	0.5s	0.1s
t 弧前 Pre-arcing	60s	—	0.5s	0.2s	—	—

NHaM 690V 平均 I-T 曲线图 (仅供参考) AVERAGE I-T CHARACTERISTICS CURVE (FOR REFERENCE ONLY)

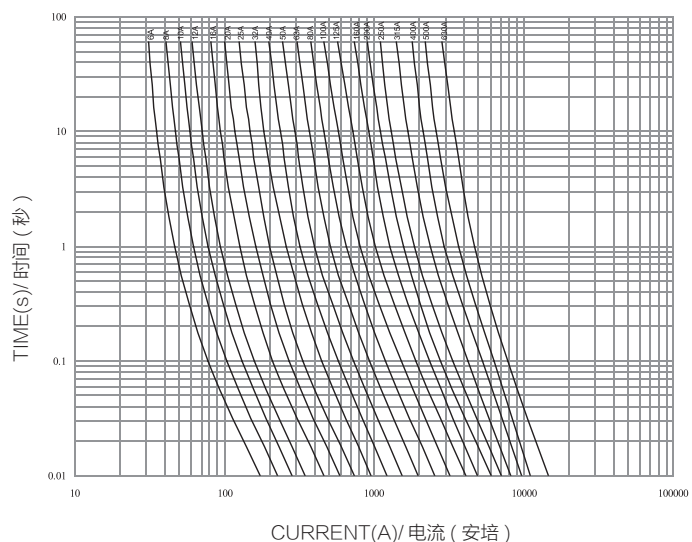

U6 DENOTES FOR 690V AC
● DENOTES FOR APPROVAL
○ DENOTES FOR PENDING

U6 表示 690V AC
● 表示已取得安全认证
○ 表示正在申请安全认证

CURRENT(A)/ 电流 (安培)

Cylindrical Fuse Holders

圆筒帽形熔断器支持件 / 底座

Dimensions/ 尺寸 :

Unit 单位: mm

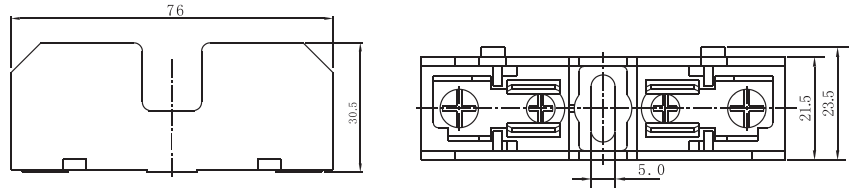

Model of product 产品型号	Applicable fuse link size 配套熔断体尺码	Rated voltage 额定电压 (V)	Rated current 额定电流 (A)	Weight(g) 重量 (g)	Safety Approvals 安全认证
HC101A	10X38	600	30	41.5	UR

Dimensions/ 尺寸 :

Unit 单位: mm

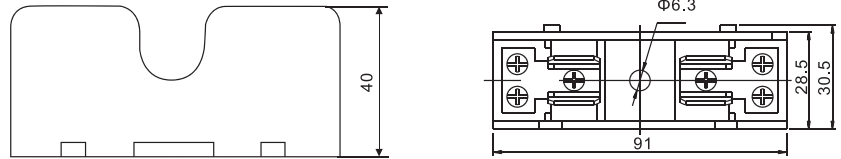

Model of product 产品型号	Applicable fuse link size 配套熔断体尺码	Rated voltage 额定电压 (V)	Rated current 额定电流 (A)	Weight(g) 重量 (g)	Safety Approvals 安全认证
HC141A	14X51	690	50	78	CCC

Dimensions/ 尺寸 :

Unit 单位: mm

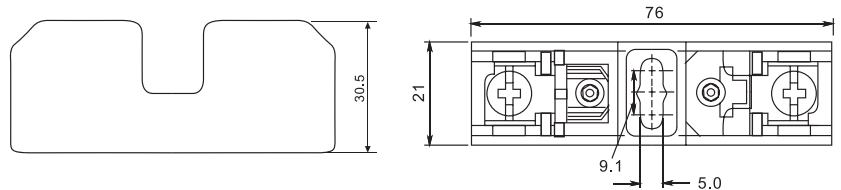

Model of product 产品型号	Applicable fuse link size 配套熔断体尺码	Rated voltage 额定电压 (V)	Rated current 额定电流 (A)	Weight(g) 重量 (g)	Safety Approvals 安全认证
HC101C	10X38	600	30	41.5	



Cylindrical Fuse Holders

圆筒帽形熔断器支持件 / 底座

HF-141A(RoHS)



Dimensions/ 尺寸 :

Unit 单位: mm

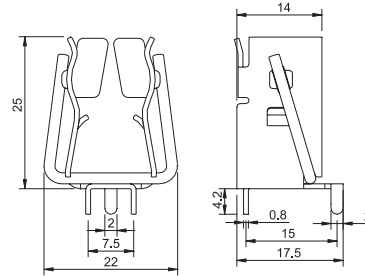

FUSE CLIP FOR 14x51 OR 14x65 FUSE
PHOSPHOR BRONZE, TIN PLATED

HF-103D(RoHS)



Dimensions/ 尺寸 :

Unit 单位: mm

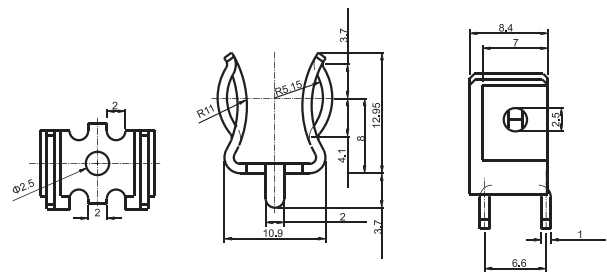

FUSE CLIP FOR 10X38 FUSE
PHOSPHOR BRONZE, NICKEL PLATED

HF-104A(RoHS)



Dimensions/ 尺寸 :

Unit 单位: mm

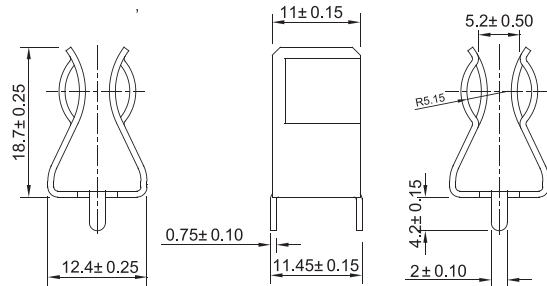

FUSE CLIP FOR 10X38 FUSE
PHOSPHOR BRONZE, NICKEL PLATED

Model of product 产品型号	Applicable fuse link size 配套熔断体尺码	Rated voltage 额定电压 (V)	Rated current 额定电流 (A)	Weight(g) 重量 (g)	Safety Approvals 安全认证
HC101B	10X38	690	25	62	CCC



Dimensions/ 尺寸 :

Unit 单位: mm

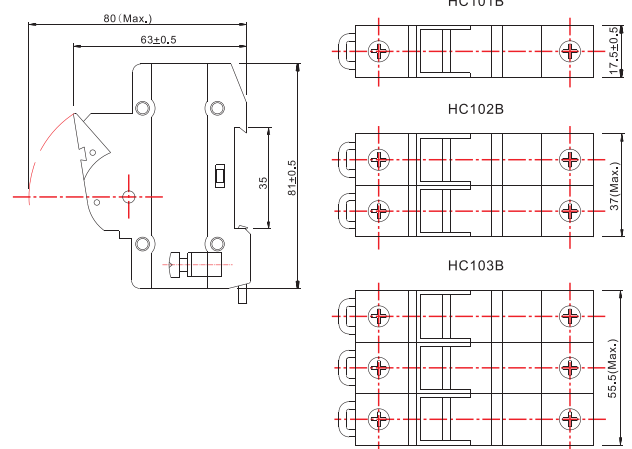

Cylindrical Fuse Holders

圆筒帽形熔断器支持件 / 底座



Dimensions/ 尺寸:

Unit 单位: mm

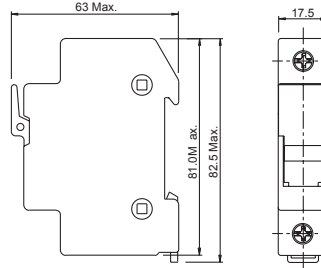

Model of product 产品型号	Applicable fuse link size 配套熔断体尺码	Rated voltage 额定电压 (V)	Rated current 额定电流 (A)	Safety Approvals 安全认证	Remark 备注
HC101D	10X38	1000	20	TUV.CGC	
			30	UL	



Dimensions/ 尺寸:

Unit 单位: mm

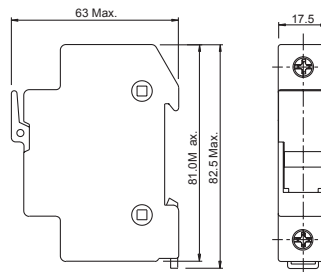

Model of product 产品型号	Applicable fuse link size 配套熔断体尺码	Rated voltage 额定电压 (V)	Rated current 额定电流 (A)	Safety Approvals 安全认证	Remark 备注
HC101DL	10X38	1000	30	UL	with indicator light



Dimensions/ 尺寸:

Unit 单位: mm

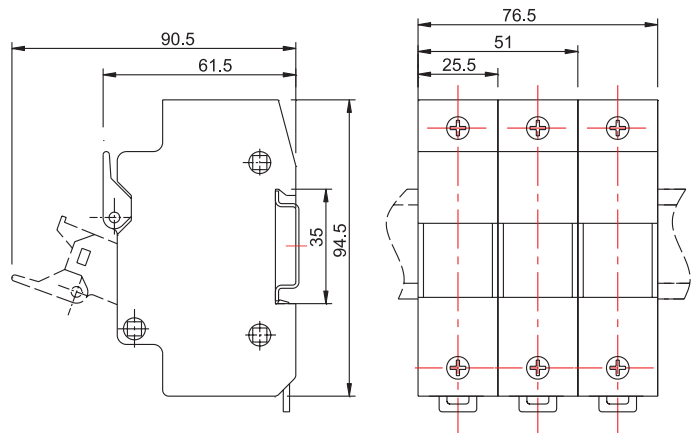

Model of product 产品型号	Applicable fuse link size 配套熔断体尺码	Rated voltage 额定电压 (V)	Rated current 额定电流 (A)	Safety Approvals 安全认证
HC141B	14X51	690	50	
		1500	20	



Fuse-base with Blade Contacts

刀型触头熔断器支持件 / 底座



Model of product 产品型号	Applicable fuse link size 配装熔断体尺码	Rated voltage 额定电压 (V)	Rated current 额定电流 (A)	Safety Approvals 安全认证
NH00B	NH000/NH00	690	160	CCC

Dimensions/ 尺寸 :

Unit 单位: mm

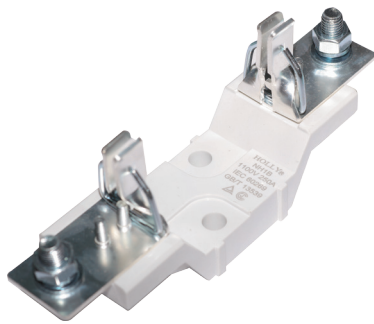
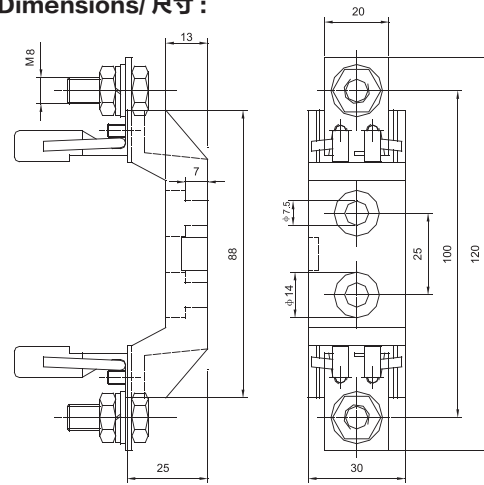

Model of product 产品型号	Catalog No. 目录编号	Applicable fuse link size 配装熔断体尺码	Rated voltage 额定电压 (V)	Rated current 额定电流 (A)	Safety Approvals 安全认证
NH1B	NH1B250U6 NH1B250U11	NH1	690	250	TUV CGC
			1100	250	
NH2B	NH2B400U6	NH2	690	400	
NH3B	NH3B630U6	NH3	690	630	

Dimensions/ 尺寸 :

Unit 单位: mm

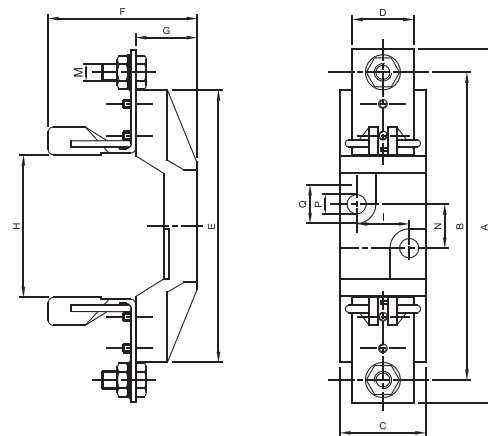

Size	A	B	C	D	E	F	G	H	I	M	N	P	Q
NH1	200	175	60	35	155	85	35	80	30	M10	25	10.5	20.5
NH2	225	200	60	35	155	90	35	80	30	M10	25	10.5	20.5
NH3	240	210	60	35	155	100	35	80	30	M10	25	10.5	20.5

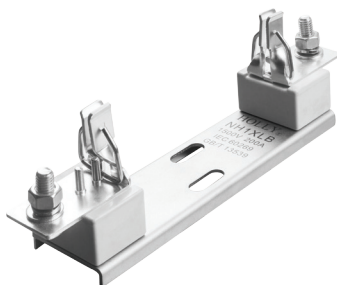

Model of product 产品型号	Catalog No. 目录编号	Applicable fuse link size 配装熔断体尺码	Rated voltage 额定电压 (V)	Rated current 额定电流 (A)	Safety Approvals 安全认证
NH1XLB	NH1XLB200U15	NH1XL	1500	200	TUV
NH2XLB	NH2XLB400U15	NH2XL	1500	400	
NH3LB	NH3LB400U11	NH2XL/NH3L	1100	400	
NH3LB	NH3LB630U11	NH2XL/NH3L	1100	630	

Dimensions/ 尺寸 :

Unit 单位: mm

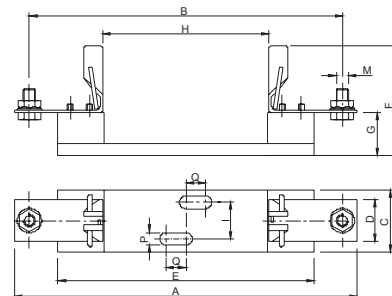

Size	A	B	C	D	E	F	G	H	I	M	P	Q
NH1XL	257	232	51	35	210	85	37	136	30	M10	10.5	16
NH2XL	281	257	51	35	210	90	37	136	30	M10	10.5	16
NH3L	292	267	51	35	210	100	37	136	30	M12	10.5	16

Microswitch 微动开关

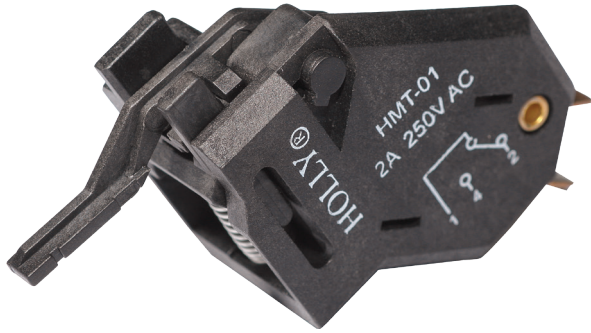

Dimensions/ 尺寸 :

Unit 单位: mm

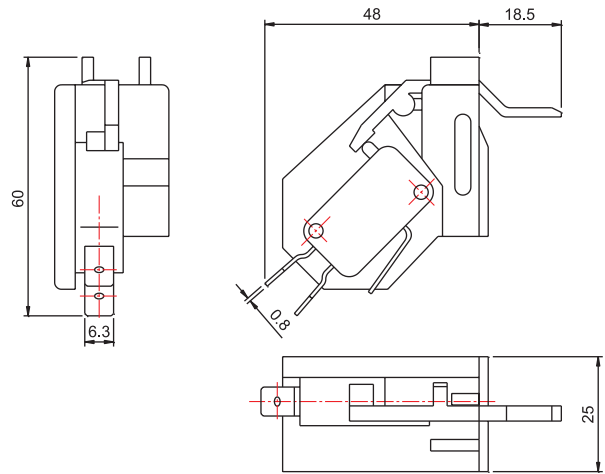

Model of product 产品型号	Rated voltage 额定电压 (V)	Rated current 额定电流 (A)	Lugs size 快接端子尺寸 (mm)
HMT-01	250V AC	2A	6.3 x 0.8mm

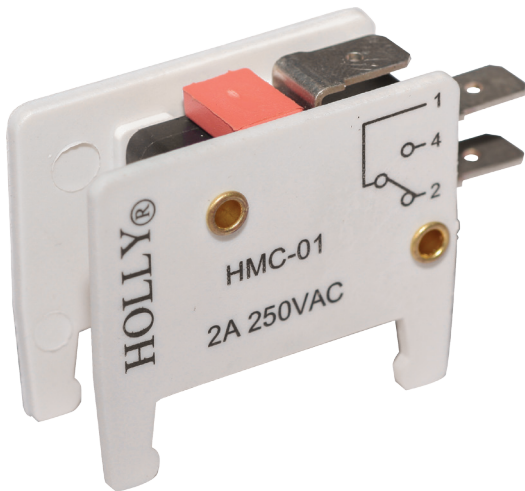

Dimensions/ 尺寸 :

Unit 单位: mm

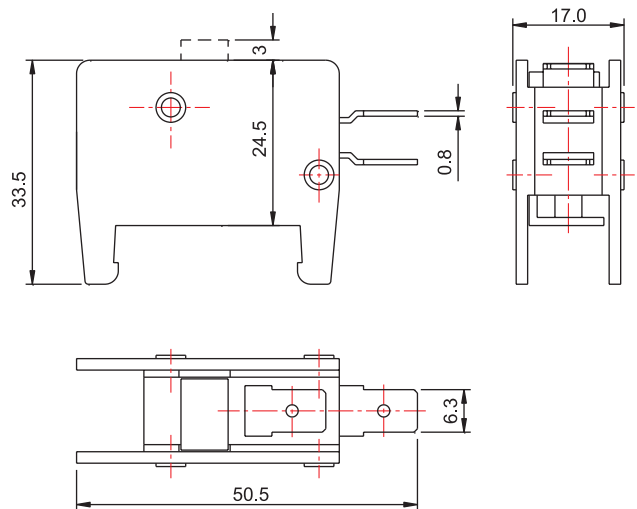

Model of product 产品型号	Rated voltage 额定电压 (V)	Rated current 额定电流 (A)	Lugs size 快接端子尺寸 (mm)
HMC-01	250V AC	2A	6.3 x 0.8mm



HOLLY 好利®



FM 40402



ISO14001:2004 CERTIFIED



TS 610112



www.hollyfuse.com

Hollyland (China) Electronics Technology Corporation Limited

829, Fangshan East 2nd Road, Xiang'an, Xiamen, China. P.C.361101
Tel: (86) 592-577 2288 Fax: (86) 592- 577 3979
E-mail: sdxm@hollyfuse.com

Hong Kong Office: Hollyland Co., Ltd.

31/F, Billion Centre, Tower A, 1 Wang Kwong Road
Kowloon Bay, Hong Kong
Tel: (852) 3666 5111 Fax: (852) 2682 1666

Shenzhen Office

No. 1002, Flat 1, Guangchengshijia Xilongxuan 10th Zone Xin'an
Bao'an, Shenzhen, Guangdong, China P.C. 518101
Tel: (86) 755-2766 2927 Fax: (86) 755-27662925

好利来(中国)电子科技股份有限公司

中国福建省厦门市翔安区舩山东二路829号 邮编: 361101
电话: (86) 592-577 2288 传真: (86) 592- 577 3979
邮箱: sdxm@hollyfuse.com

香港子公司: 好利来有限公司

香港九龙湾宏光道1号亿京中心A座31楼
电话: (852) 3666 5111 传真: (852) 2682 1666

深圳办事处

中国广东省深圳市宝安区新安10区冠城世家曦龙轩1座1002室
电话: (86) 755-2766 2927 传真: (86) 755-27662925
邮编: 518101
