

Cylindrical Fuse Holders

圆筒帽形熔断器支持件 / 底座

Dimensions/ 尺寸 :

Unit 单位: mm

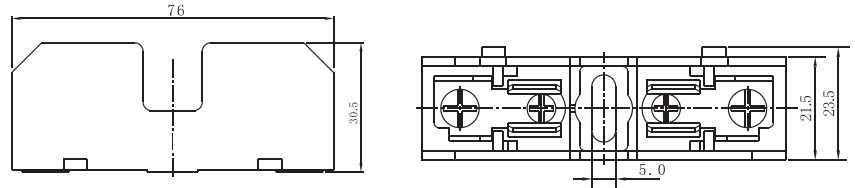

Model of product 产品型号	Applicable fuse link size 配装熔断体尺码	Rated voltage 额定电压 (V)	Rated current 额定电流 (A)	Weight(g) 重量 (g)	Safety Approvals 安全认证
HC101A	10X38	600	30	41.5	UR

Dimensions/ 尺寸 :

Unit 单位: mm

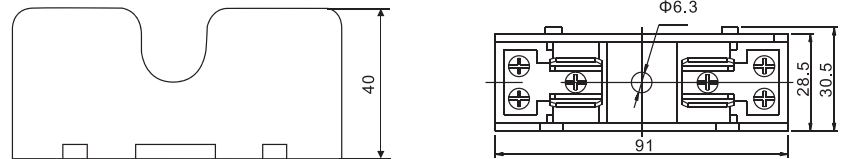

Model of product 产品型号	Applicable fuse link size 配装熔断体尺码	Rated voltage 额定电压 (V)	Rated current 额定电流 (A)	Weight(g) 重量 (g)	Safety Approvals 安全认证
HC141A	14X51	690	50	78	CCC

Dimensions/ 尺寸 :

Unit 单位: mm

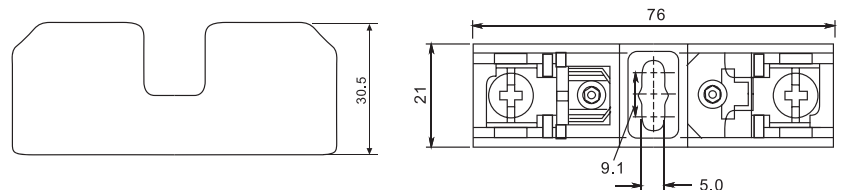

Model of product 产品型号	Applicable fuse link size 配装熔断体尺码	Rated voltage 额定电压 (V)	Rated current 额定电流 (A)	Weight(g) 重量 (g)
HC101C	10X38	600	30	41.5

Cylindrical Fuse Holders

圆筒帽形熔断器支持件 / 底座

HF-103D(RoHS)



Dimensions/ 尺寸:

Unit 单位: mm

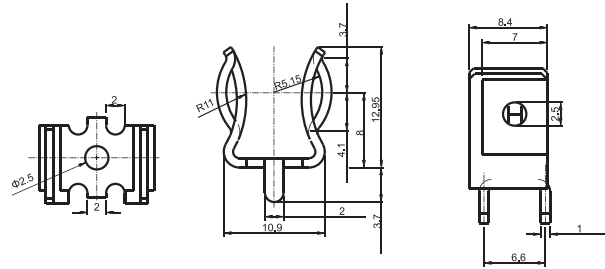

FUSE CLIP FOR 10X38 FUSE
PHOSPHOR BRONZE, NICKEL PLATED

HF-104A(RoHS)



Dimensions/ 尺寸:

Unit 单位: mm

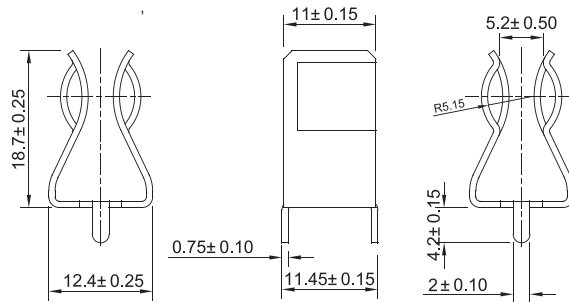

FUSE CLIP FOR 10X38 FUSE
PHOSPHOR BRONZE, NICKEL PLATED

Model of product 产品型号	Applicable fuse link size 装配熔断体尺码	Rated voltage 额定电压 (V)	Rated current 额定电流 (A)	Weight(g) 重量 (g)	Safety Approvals 安全认证
HC101B	10X38	690	25	62	CCC

Dimensions/ 尺寸:

Unit 单位: mm

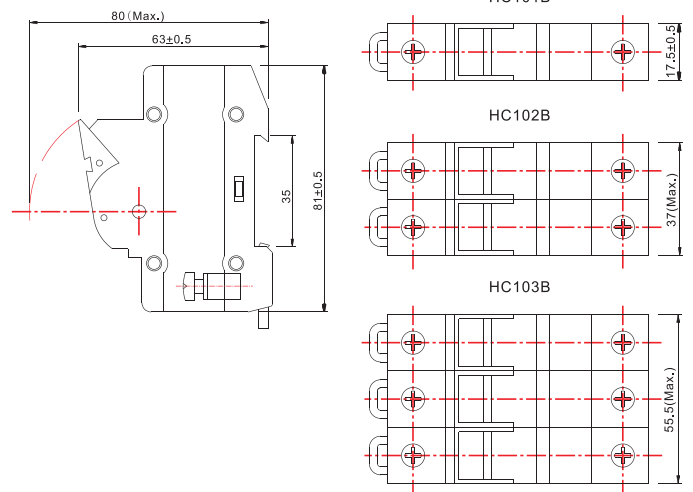

Cylindrical Fuse Holders

圆筒帽形熔断器支持件 / 底座



Dimensions/ 尺寸 :

Unit 单位: mm

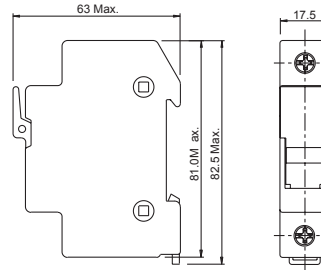

Model of product 产品型号	Applicable fuse link size 配装熔断体尺码	Rated voltage 额定电压 (V)	Rated current 额定电流 (A)	Safety Approvals 安全认证	Remark 备注
HC101D	10X38	1000	20	TUV.CGC	



Dimensions/ 尺寸 :

Unit 单位: mm

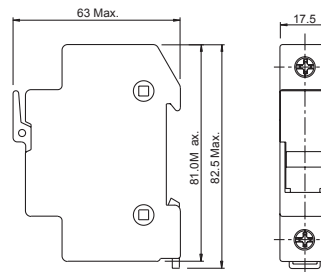

Model of product 产品型号	Applicable fuse link size 配装熔断体尺码	Rated voltage 额定电压 (V)	Rated current 额定电流 (A)	Safety Approvals 安全认证	Remark 备注
HC101DL	10X38	1000	20		with indicator light

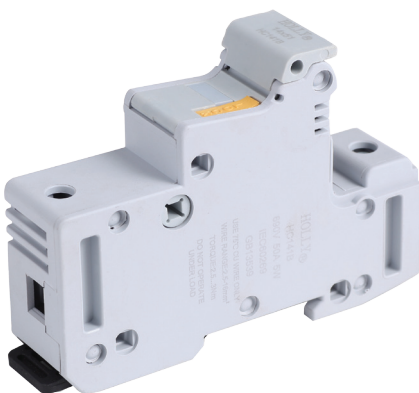

Dimensions/ 尺寸 :

Unit 单位: mm

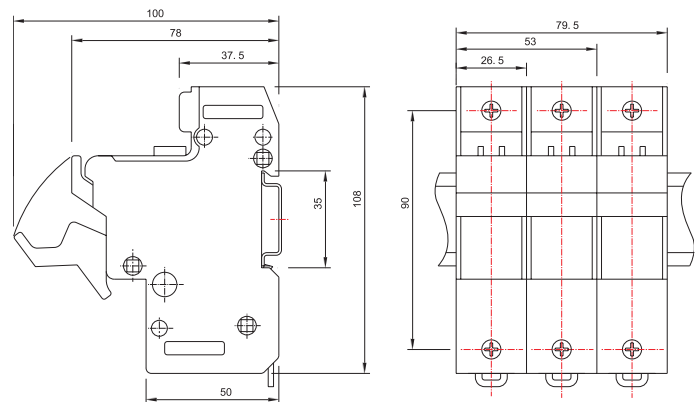

Model of product 产品型号	Applicable fuse link size 配装熔断体尺码	Rated voltage 额定电压 (V)	Rated current 额定电流 (A)	Safety Approvals 安全认证
HC141B	14X51	690	50	
		1000	32	