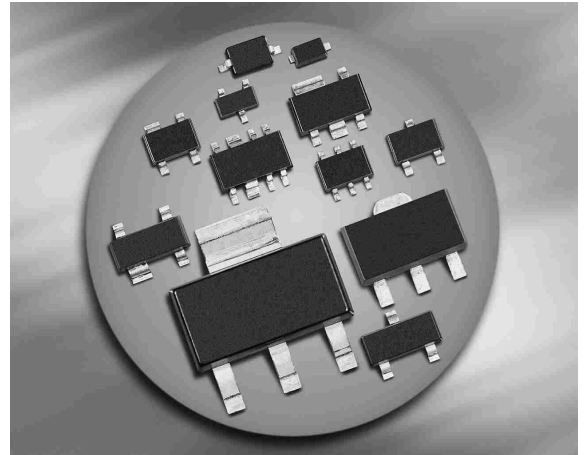

RF ESD Protection Diodes

- ESD / transient protection of RF antenna / interfaces or ultra high speed data lines acc. to:
IEC61000-4-2 (ESD): ± 20 kV (contact)
IEC61000-4-4 (EFT): 40 A (5/50 ns)
IEC61000-4-5 (surge): 10 A (8/20 μ s)
- Ultra low capacitance of 1 pF typ.
(0.5 pF per diode)
- Low clamping voltage
- Pb-free (ROHS compliant) package

Applications in anti-parallel configuration

- For low RF signal levels without superimposed DC voltage: e.g. GPS, WLAN, Bluetooth

Applications in rail-to-rail configuration

- For high RF signal levels or low RF signal levels with superimposed DC voltage: e.g. HDMI, S-ATA, Gbit Ethernet

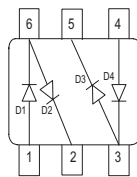
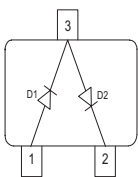
ESD1P0RFW
ESD1P0RFS

Type	Package	Configuration	Marking
ESD1P0RFS	SOT363	2 channels	E6s
ESD1P0RFW	SOT323	1 channel	E6s

Maximum Ratings at $T_A = 25^\circ\text{C}$, unless otherwise specified

Parameter	Symbol	Value	Unit
ESD contact discharge ¹⁾	V_{ESD}	20	kV
Peak pulse current ($t_p = 8 / 20 \mu\text{s}$) ²⁾	I_{pp}	10	A
Operating temperature range	T_{op}	-55...150	°C
Storage temperature	T_{stg}	-65...150	

Electrical Characteristics at $T_A = 25^\circ\text{C}$, unless otherwise specified

Parameter	Symbol	Values			Unit
		min.	typ.	max.	
Characteristics -					
Reverse working voltage ³⁾	V_{RWM}	-	-	70	V
Reverse current $V_R = 70 \text{ V}$	I_R	-	-	100	nA
Forward clamping voltage ²⁾ $I_{\text{PP}} = 3 \text{ A}, t_p = 8/20 \mu\text{s}$ $I_{\text{PP}} = 10 \text{ A}, t_p = 8/20 \mu\text{s}$	V_{FC}	-	4 12	7 15	V
Line capacitance ⁴⁾ $V_R = 0 \text{ V}, f = 1 \text{ MHz}$ $V_R = 0 \text{ V}, f = 1 \text{ MHz}$, for Application example 4	C_T	-	1 0.5	1.5 0.75	pF
Series inductance (per diode) SOT323 SOT363	L_S	-	1.4 1.6	- -	nH

¹⁾ V_{ESD} according to IEC61000-4-2, only valid in anti-parallel or rail-to-rail connection.

Please refer to the application examples.

²⁾ I_{pp} according to IEC61000-4-5, only valid in anti-parallel or rail-to-rail connection.

Please refer to the application examples.

³⁾Only valid in rail-to-rail configuration $V_{\text{CC}} \geq V_{\text{RWM}}$

⁴⁾Total capacitance line to ground (2 diodes in parallel)

Forward clamping voltage $V_{FC} = f(I_{PP})$

$t_p = 8 / 20 \mu s$

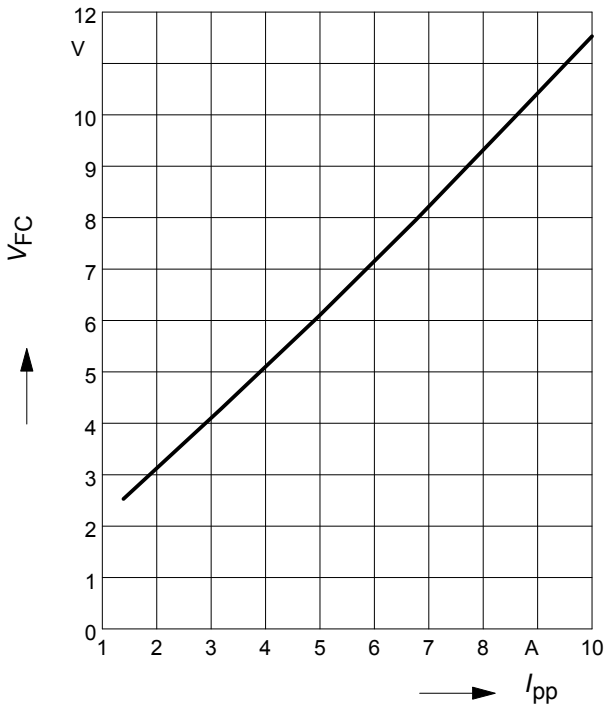

Reverse current $I_R = f(V_R)$

$T_A = \text{Parameter}$

in rail-to-rail configuration

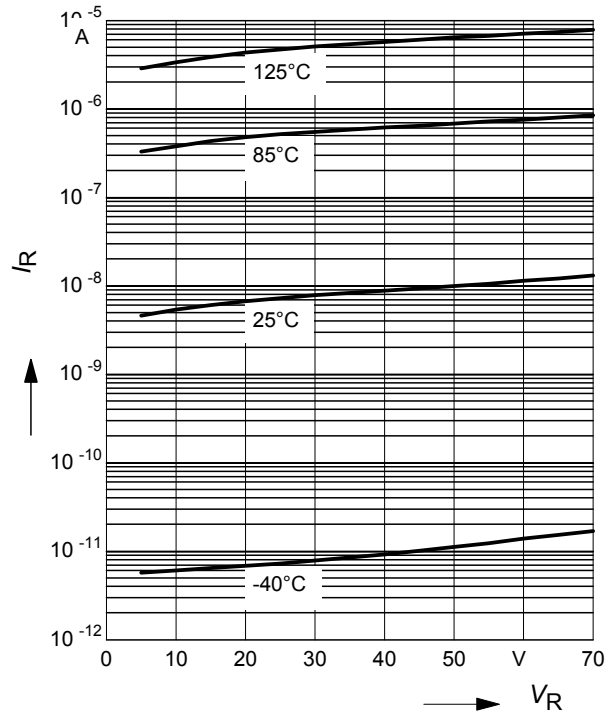

Forward current $I_F = f(V_F)$

$T_A = \text{Parameter}$

in anti-parallel configuration

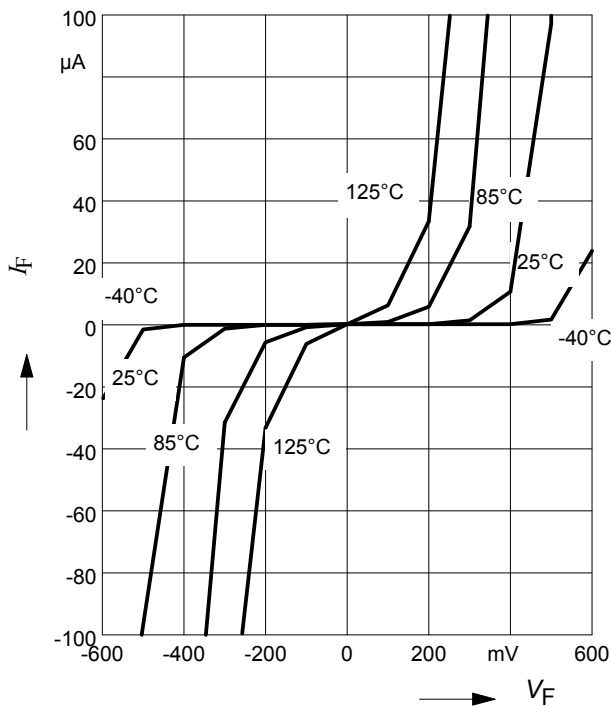

Line capacitance $C_T = f(f)$

$V_R = 0 V$

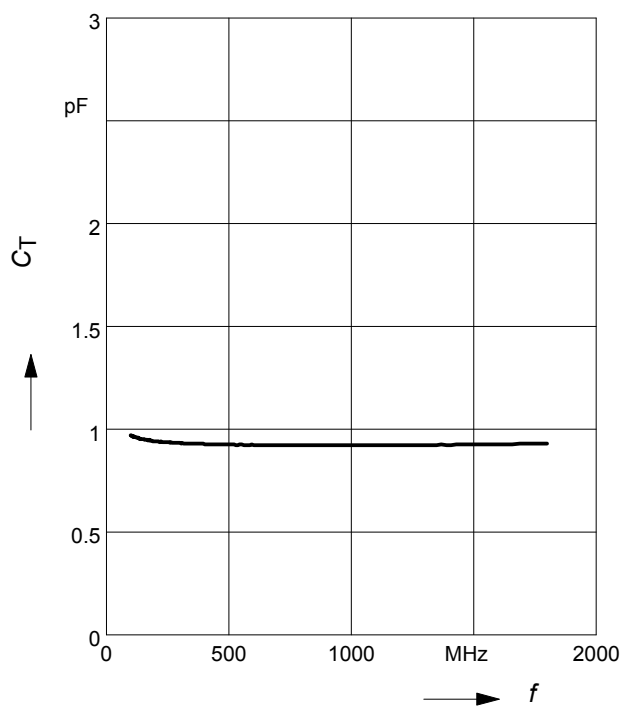

Insertion loss $|S_{21}|^2 = f(f)$

$V_R = 0$ V, line to ground, $Z = 50 \Omega$

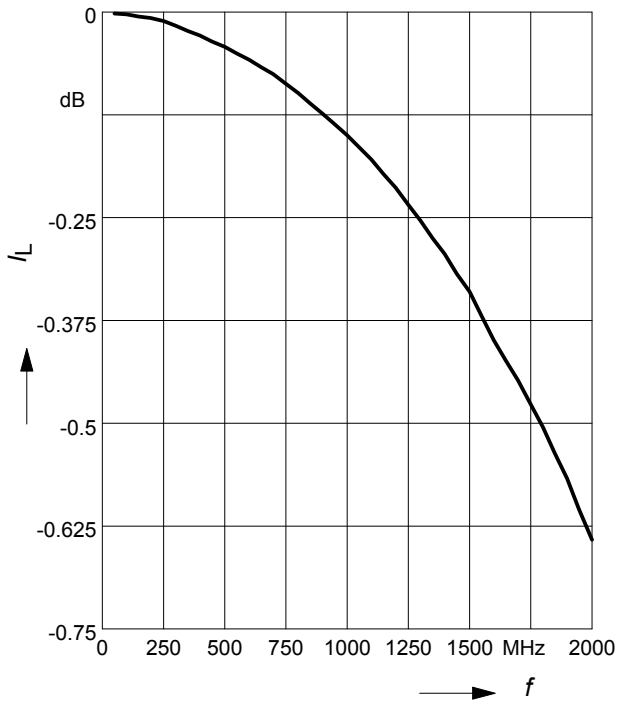

1. Application example ESD1P0RFW

1 channel, anti-parallel configuration

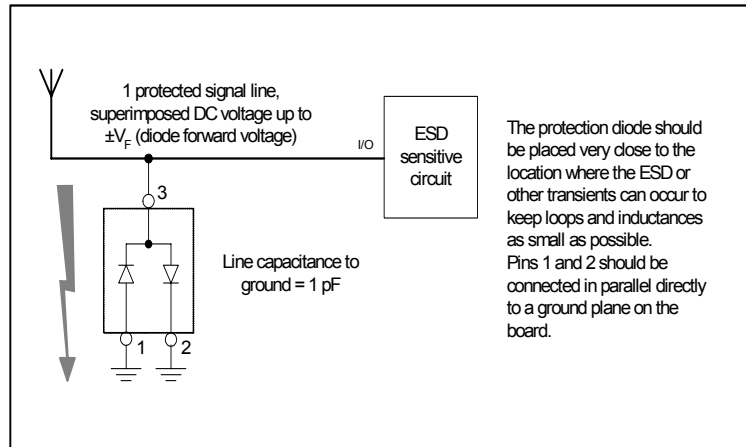

2. Application example ESD1P0RFW

1 channel, rail-to-rail configuration

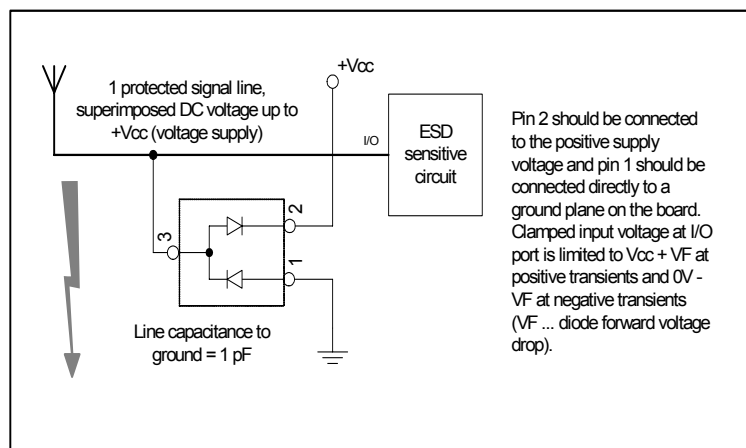

3. Application example ESD1P0RFS

2 channels, anti-parallel configuration

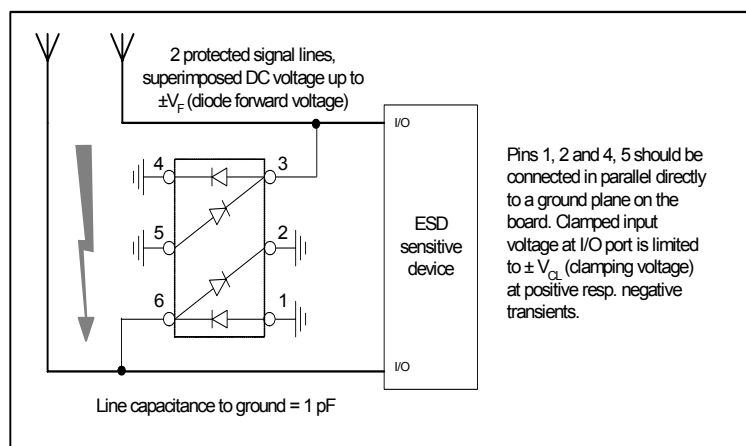

4. Application example ESD1P0RFS

1 channel, low capacitance anti-parallel configuration

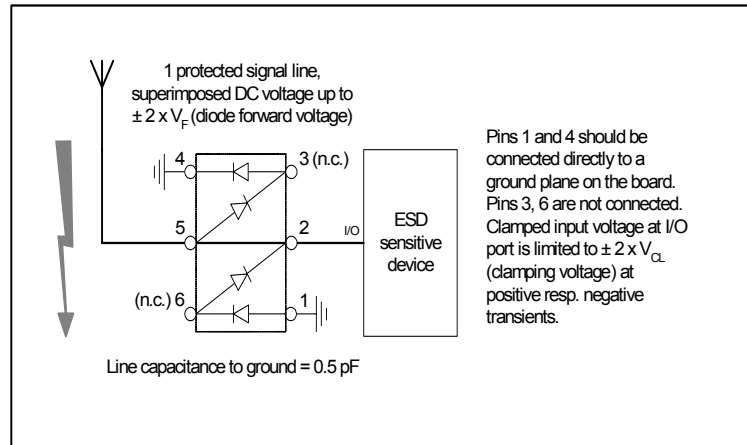

Package Outline



Foot Print



Marking Layout (Example)

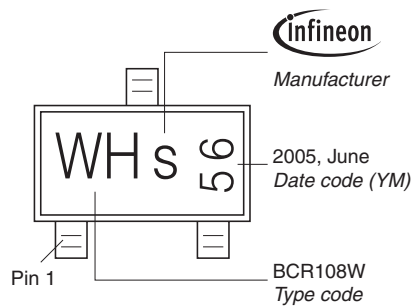

Standard Packing

Reel \varnothing 180 mm = 3.000 Pieces/Reel
 Reel \varnothing 330 mm = 10.000 Pieces/Reel

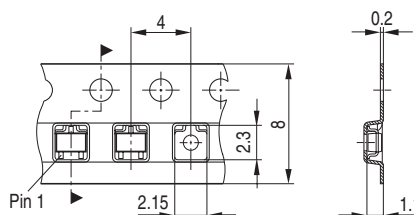

Package Outline

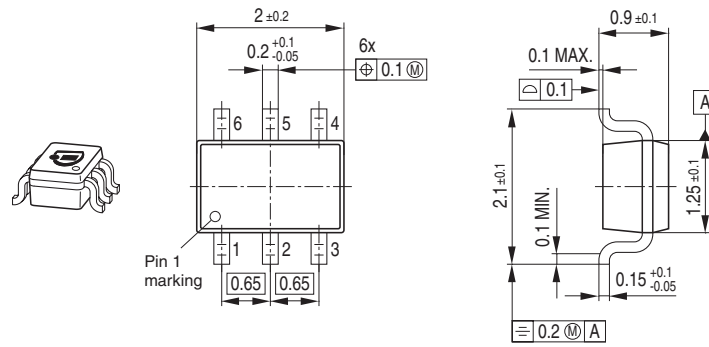

Foot Print

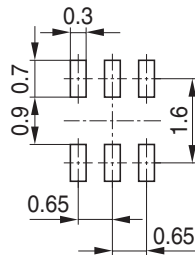

Marking Layout (Example)

Small variations in positioning of Date code, Type code and Manufacture are possible.

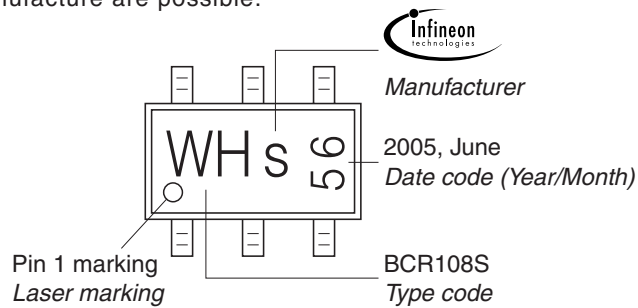

Standard Packing

Reel \varnothing 180 mm = 3.000 Pieces/Reel
 Reel \varnothing 330 mm = 10.000 Pieces/Reel

For symmetric types no defined Pin 1 orientation in reel.

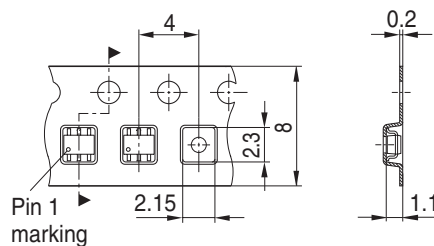

Edition 2009-11-16

**Published by
Infineon Technologies AG
81726 Munich, Germany**

**© 2009 Infineon Technologies AG
All Rights Reserved.**

Legal Disclaimer

The information given in this document shall in no event be regarded as a guarantee of conditions or characteristics. With respect to any examples or hints given herein, any typical values stated herein and/or any information regarding the application of the device, Infineon Technologies hereby disclaims any and all warranties and liabilities of any kind, including without limitation, warranties of non-infringement of intellectual property rights of any third party.

Information

For further information on technology, delivery terms and conditions and prices, please contact the nearest Infineon Technologies Office ([<www.infineon.com>](http://www.infineon.com)).

Warnings

Due to technical requirements, components may contain dangerous substances. For information on the types in question, please contact the nearest Infineon Technologies Office.

Infineon Technologies components may be used in life-support devices or systems only with the express written approval of Infineon Technologies, if a failure of such components can reasonably be expected to cause the failure of that life-support device or system or to affect the safety or effectiveness of that device or system. Life support devices or systems are intended to be implanted in the human body or to support and/or maintain and sustain and/or protect human life. If they fail, it is reasonable to assume that the health of the user or other persons may be endangered.