

30 Watt- LD30W Series

CONSTANT CURRENT LED DRIVER WITH DIMMING & DIM TO ZERO



DIMMING

LD30W Series

30W

Model: LD30W Series

- Drive Mode: Constant Current
- Technology: Advanced PFC Off-Line Switch Mode
- Output Power: 30W Max.
- Number of Outputs: One
- Output Voltages: 9VDC - 85VDC
- Output Currents: 350mA - 2500mA
- Optional 0-10V Linear Dimming 1% to 100%
- Dims to Zero @ $\leq 1.0V$, Standby Power $\leq 0.5W$

Environmental

1. Operating temperature: Tc 90C Maximum. Reference -40 to +60°C ambient
2. UL Recognized, UL Type HL
3. Storage temperature range: -40 to +85°C
4. Humidity (non-condensing): 5% - 95%RH
5. Cooling: Convection
6. Vibration Frequency: 5-55Hz/2g, 30 minutes
7. Impact resistance: 1g/s
8. MTBF@ Tc = 80°C: 474,000 hours @ Full Load per MIL-HDBK-217F Notice 2

Safety and Compliance

1. UL8750, EN61347, CSA 22.2 safety recognized, UL Type HL
2. FCC, 47CFR Part 15 & EN55015 compliant.
3. Water resistant and Dust Proof Design: IP66, NEMA4, for Dry & Damp Locations.
4. Compact, Lightweight Design.
5. Safety Isolation between Primary, Secondary & 0-10V Dim
6. Meets EN61000-3-2 & EN61000-3-3 Class C
7. Protection: output over-voltage, output over-current, output short circuit, over temperature, auto-recovery.
8. EN61000-4-5: 2kV L-N, 8/20 μ sec surge protection.

Electrical Specifications at 25°C

- Input voltage range: 120 to 277Vac (Full Range 100 to 305VAC)
- Frequency: 47- 63HZ
- Power Factor: ≥ 0.90 at 120/230/277Vac $\geq 50\%$ Load
- THD%: $\leq 20\%$ at 120/230/277Vac $\geq 50\%$ Load
- Inrush current: <50A at 25C, 277Vac, cold start, Full Load
- Input current: 0.30A Maximum at 120Vac, 60Hz, Full Load
- Efficiency: 85% typical 230Vac Full Load
- Line regulation accuracy: $\pm 3\%$
- Load regulation accuracy: $\pm 4\%$
- Leakage current: 277Vac, 700uA maximum



IP66



Constant Current Dimmable Versions

Part Number ⁽²⁾	US Class 2	CN Class 2	Output Voltage Range	Output Constant Current	Current Accuracy	Output Power Maximum	Typical Efficiency ⁽¹⁾
LD30W-85-C0350-RD	NO	NO	42 - 85 VDC	350 mA	$\pm 5\%$	30W	86%
LD30W-75-C0400-RD	NO	NO	37 - 75 VDC	400 mA	$\pm 5\%$	30W	86%
LD30W-66-C0450-RD	NO	NO	33 - 66 VDC	450 mA	$\pm 5\%$	30W	85%
LD30W-54-C0560-RD	YES	YES	27 - 54 VDC	560 mA	$\pm 5\%$	30W	85%
LD30W-42-C0700-RD	YES	YES	21 - 42 VDC	700 mA	$\pm 5\%$	30W	85%
LD30W-36-C0830-RD	YES	YES	18 - 36 VDC	830 mA	$\pm 5\%$	30W	84%
LD30W-24-C1250-RD	YES	YES	12 - 24 VDC	1250 mA	$\pm 5\%$	30W	84%
LD30W-18-C1660-RD	YES	YES	9 - 18 VDC	1660 mA	$\pm 5\%$	30W	83%

Notes

1. Typical efficiency measured at 230VAC input, full load
2. -RD 0-10V standard dimmable part numbers shown. For other versions change designator at the end of the part number. For Example: LD30W-36-C0830 is non-dimmable version.
3. -RD 0-10V & Resistance dimmable version comes with an extra two wires +VIOLET/-PINK on the output side. (Legacy DIM- = GRAY)
4. -RD 0-10V Dimming is compatible with most quality 0-10V wall dimmers and direct 0-10V analog signal. See page 3 for details.

Custom designs available. Please consult with the factory.

Specifications subject to change without notice

30W

LD30W Series

DIMMING



LED Optimized Drivers

30 Watt- LD30W Series

CONSTANT CURRENT LED DRIVER WITH DIMMING & DIM TO ZERO

Mechanical Dimensions: Inches [mm]

Material: Black PC ABS Plastic Case
Fully Encapsulated
Weight: 233 grams (8.2 oz) Typical

Labeling Example

AC INPUT
L = BLACK
N = WHITE

0-10V Dimmable LED Optimized Driver
EPtronics, Inc.
www.EPtronics.com
800 643-0688/310 536-0780

Part Number: LD30W-36-C0830-RD
Input Voltage: 120-277VAC 50/60Hz
Input Current: 0.30 Amp Max @ 120Vac
Output Voltage: 18-36 VDC, 30W Maximum
Output Current: 830 mA Constant Current
UL & cUL Class 2 Output & 0-10V CCR Dimming
Isolated Class 2 Dim suitable for Class 1 or 2 circuit
Suitable for use in Dry & Damp Locations
UL Type HL

DC OUTPUT
+ = RED
- = BLUE

0-10V DIMMING
DIM+ = VIOLET
DIM- = PINK

IP66

REV F

FC
RoHS

YG Made in China

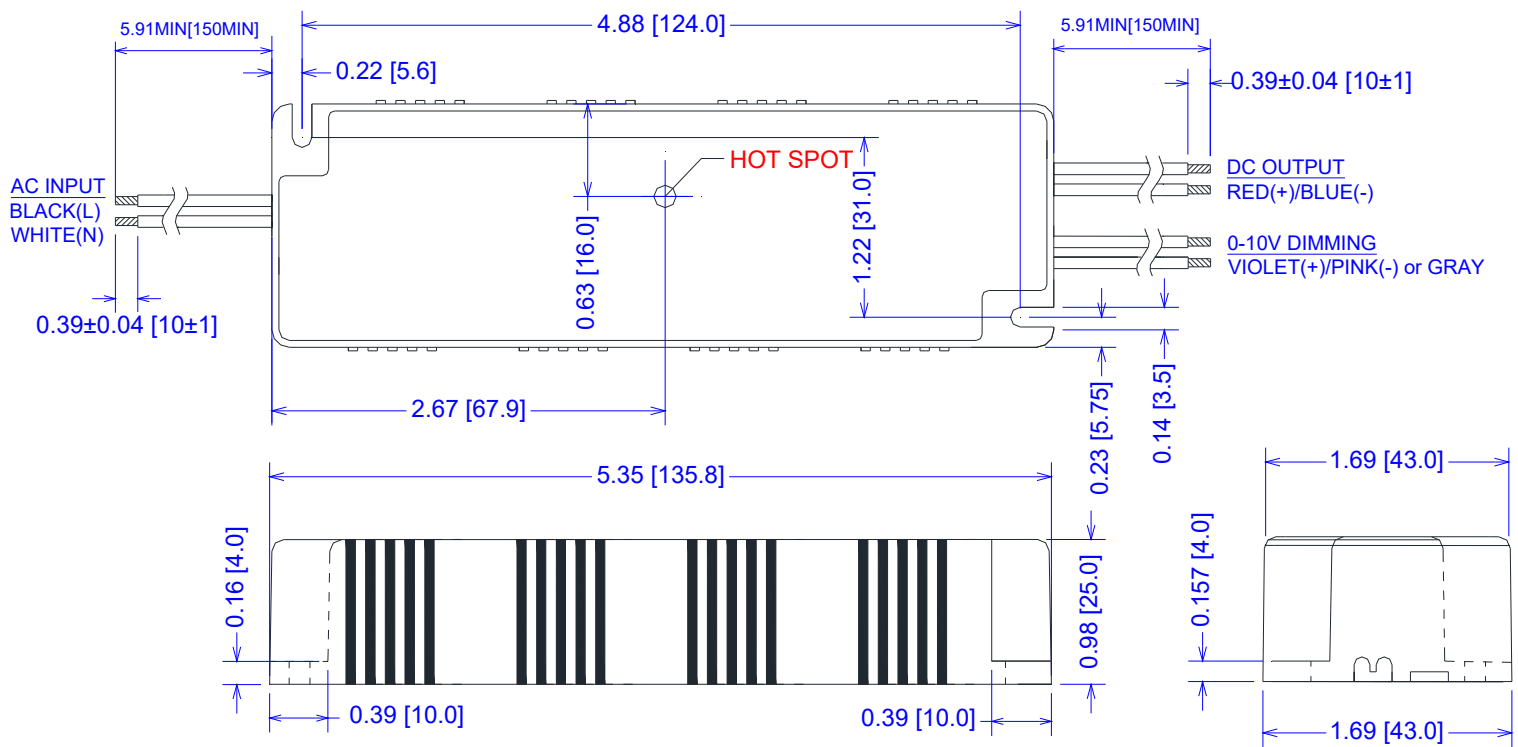

30 Watt- LD30W Series

CONSTANT CURRENT LED DRIVER WITH DIMMING & DIM TO ZERO

-RD 2-Wire 0-10V CCR Dimming Scheme

Parameters	Minimum	Typical	Maximum
Source Current out of 0-10V VIOLET Wire	0mA	—	1.0mA
Absolute Voltage Range on 0-10V (+) VIOLET Wire	-2.0V	—	+15V

Notes

- RD 0-10V dimmable version comes with an extra two wires +VIOLET/-PINK on the output side.
- RD version is compatible with most 0-10V Wall Slide dimmers and direct 0-10V analog signal.
Recommended wall slide dimmer is Leviton IP710 or equivalent
- RD 0-10V dimmable version is Dim to Zero @ ~1.00V and 1% Min Dim.
- RD 0-10V dimmable version output will be 100% with VIOLET/PINK open and minimum with VIOLET/PINK Shorted.
- Dimming wires +VIOLET/-PINK must not touch any other wires or damage to LED Driver can occur.

-RD 2-Wire Resistance Dimming Scheme

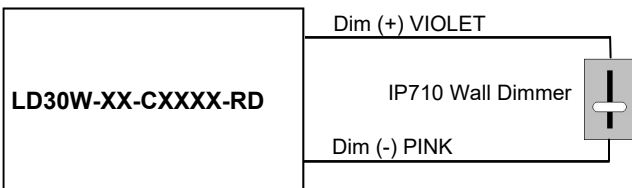

-RD 2-Wire 0-10V Analog Dimming Scheme

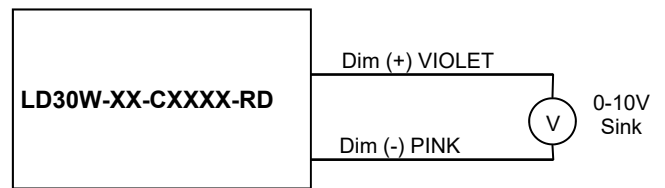

% Output Current Vs. 0-10V DC Dimming Input

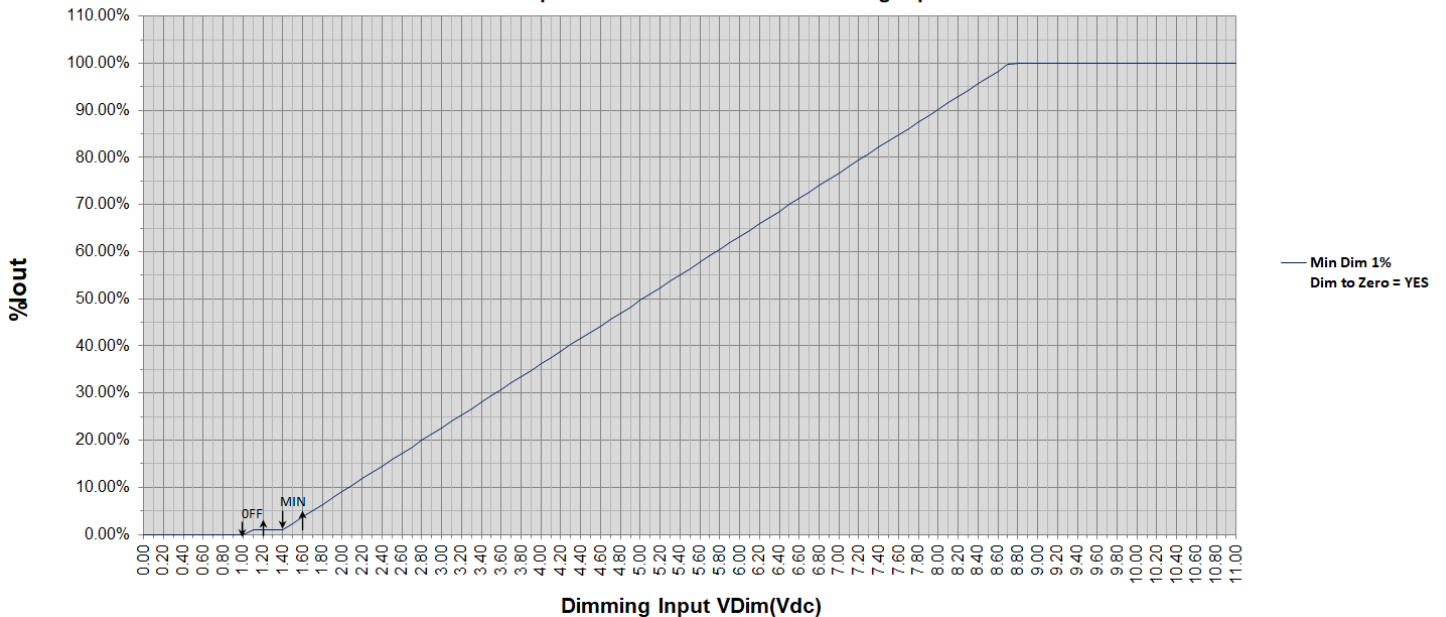

30 Watt- LD30W Series

CONSTANT CURRENT LED DRIVER WITH DIMMING & DIM TO ZERO

Input Specifications

Parameter	Min.	Typ.	Max.	Notes/Conditions
Input Voltage	100 Vac	—	305 Vac	120, 230, 240, 277 Vac Nominal Values
Input Frequency	47 Hz	—	63 Hz	50/60Hz Nominal
Input AC Current	—	—	0.30 A	Measured at 120Vac/60Hz Input, Output Full load.
	—	—	0.13 A	Measured at 277Vac/60Hz Input, Output Full load.
Inrush Current (Peak) Ipk 10%Pw <60usec	—	—	40 A	Measured at 120Vac/60Hz Input, Output Full Load, Ta 25°C, Cold Start
	—	—	50 A	Measured at 277Vac/60Hz Input, Output Full Load, Ta 25°C, Cold Start
Leakage Current	—	—	0.50mA	Measured at 120Vac/60Hz Input, Output Full load.
	—	—	0.70mA	Measured at 277Vac/60Hz Input, Output Full load.
THD	—	—	20%	Measured at 120, 230, 277Vac Input, Output ≥50% Load
Power Factor (PF)	0.90	—	—	Measured at 120, 230, 277Vac Input, Output ≥50% Load
Standby Power (Dim to Zero)	—	—	0.5W	Measured at 120/230/277Vac, Dimmed to Zero (Vdim ≤0.9V)

Output Specifications

Parameter	Min.	Typ.	Max.	Notes/Conditions
DC Output Voltage	Per Table	—	Per Table	Per Tables on Page 1
DC Output Constant Current	-5%	Per Table	+5%	Per Tables on Page 1
Output Power	—	—	Per Table	Per Tables on Page 1
Ripple & Noise (Vpk-pk)	—	—	20% Vo	20 MHz BW, Full load output in parallel with 0.1 μF ceramic & 10 μF Electrolytic.
Ripple (Ipk-pk)	—	—	50% Io	20 MHz BW, Full load output in parallel with 0.1 μF ceramic & 10 μF Electrolytic. 120 Hz component
Start-up Time	—	—	500 mS	Measured at 120Vac/60Hz Input, Output Full load, VDim = 10.0V
Output Overshoot	-5%	—	+10%	Measured at 120Vac/60Hz Input, Output Full load @ AC Power ON

Environmental Specifications

Parameter	Min.	Typ.	Max.	Notes/Conditions
Case Temperature (Tc)	-40 °C	—	+90 °C	Measured at location specified on case.
Operating Temperature (Ta)	-40 °C	—	+60 °C	This is a reference range. Tc controls temperature range.
Storage Temperature (Ts)	-40 °C	—	+85 °C	Non operating temperature range.
Operating Humidity	—	—	95% RH	Relative Humidity, non-condensing.
Vibration	5 Hz	—	55 Hz	2G, 10 minutes/1 cycle, period 30 minutes, each along X, Y, Z axis.
MTBF	—	474,000 Hours	—	MIL-HDBK-217F Notice 2, Tc = 80C, Output Full Load.

Protection Specifications

Parameter	Min.	Typ.	Max.	Notes/Conditions
Output Short Circuit (SCP)	—	—	—	No Damage, Auto recovery after short is removed.
Output Over Current (OCP)	—	—	+10% Io	Constant Current Limiting circuit.
Output Over Voltage (OVP)	—	—	+20% Vo	No Damage, Auto recovery after fault is removed.
Over Temp Protection (OTP)	95 °C	—	100 °C	Iout Foldback at Tc ≥95C, OFF @ Tc ~110C

30 Watt- LD30W Series

CONSTANT CURRENT LED DRIVER WITH DIMMING & DIM TO ZERO

Safety Compliance

Safety	Notes/Standards
UL/CUL	UL8750 & CAN/CSA C22.2 No. 250.13, UL Type HL
CE	EN61347-1, EN61347-2-13, EN62493
Dielectric Withstand Voltage	Input to Output & Dimming: 3750 Vac (CE, ENEC covers UL 2000V requirement) Dimming to Output: 2500 Vac
Isolation Resistance	Input to Output: >100 MΩ, 500VDC @ 25 °C, 70 % RH
0-10V Class 2 Isolated Dimming Circuit	Dim+ VIOLET/Dim- PINK are Class 2 Isolated from all other inputs & outputs. 0-10VDC Dimming suitable for Class 1 or Class 2 circuit.
Sound Rating	<24dB Class A @ 1 Meter

EMC Compliance

Standard	Notes/Conditions
FCC, 47CFR Part 15 ANSI C63.4	Class B @120Vac, Class A @ 277Vac
EN 55015	Limits and methods of measurement of radio disturbance characteristics of electrical lighting and similar equipment.
EN 61000-3-2	Part 3-2: Limits for harmonic current emissions Class C, ≥50% Rated Power
EN 61000-3-3	Part 3-3: Limitation of voltage changes, voltage fluctuations and flicker.
EN 61000-4-5	Part 4-5: Surge Immunity test, 2 kV L-N
Energy Star	Energy Star transient protection: Ballast or driver shall comply with ANSI/IEEE C62.41.1-2002 and ANSI/IEEE C62.41.2-2002, Category A operation. The line transient shall consist of seven strikes of a 100 kHz ring wave, 2.5 kV level, for both common mode and differential mode.

Power Factor Curves (Typical)

PF vs. Output Power

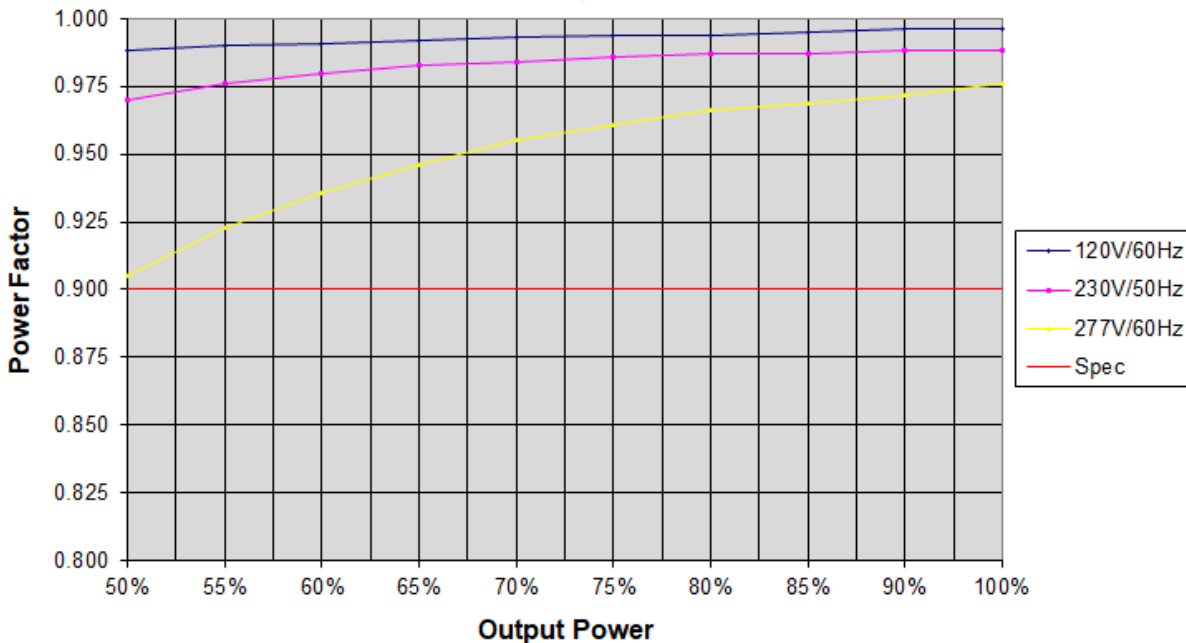

30 Watt- LD30W Series

CONSTANT CURRENT LED DRIVER WITH DIMMING & DIM TO ZERO

THD Curves (Typical)

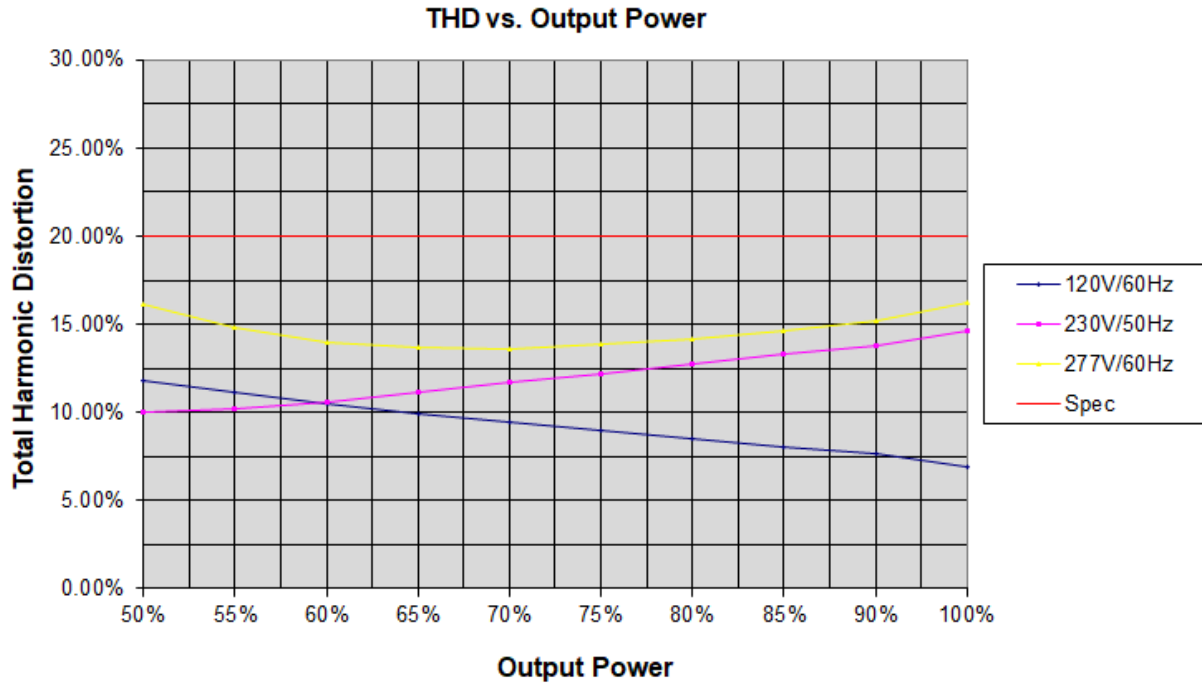

Efficiency Curve (Typical)

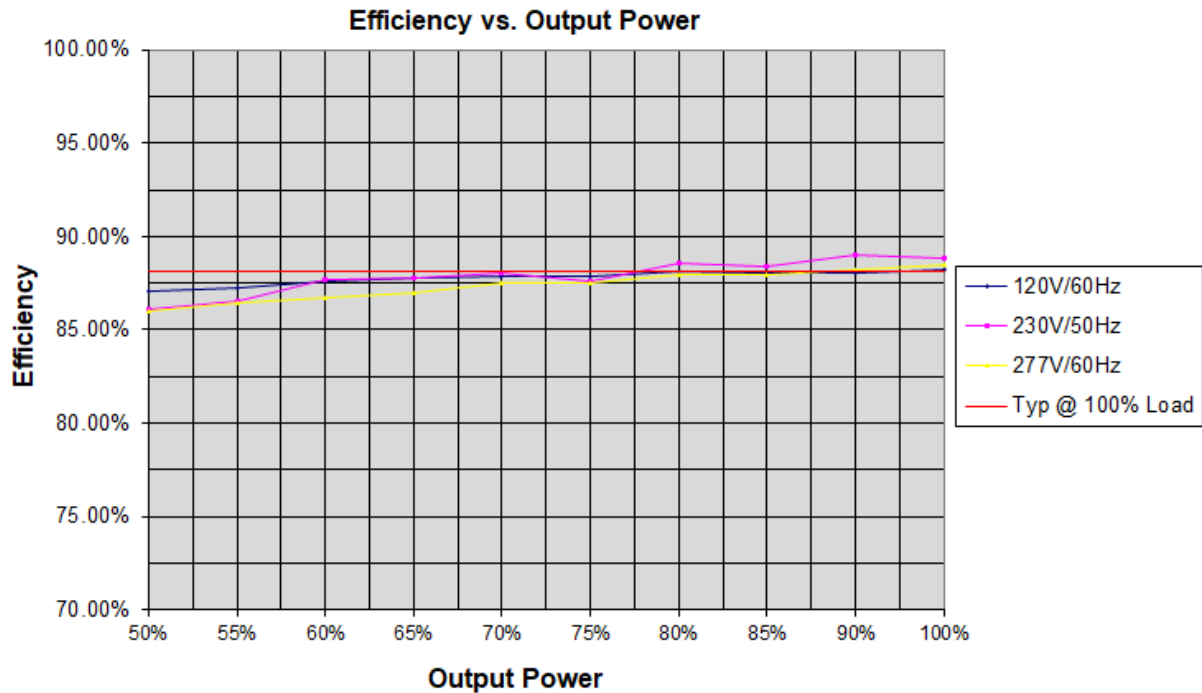

30 Watt- LD30W Series

CONSTANT CURRENT LED DRIVER WITH DIMMING & DIM TO ZERO

Life vs. Ambient Temperature

LD30W Estimated Life Full Load @ 120Vac

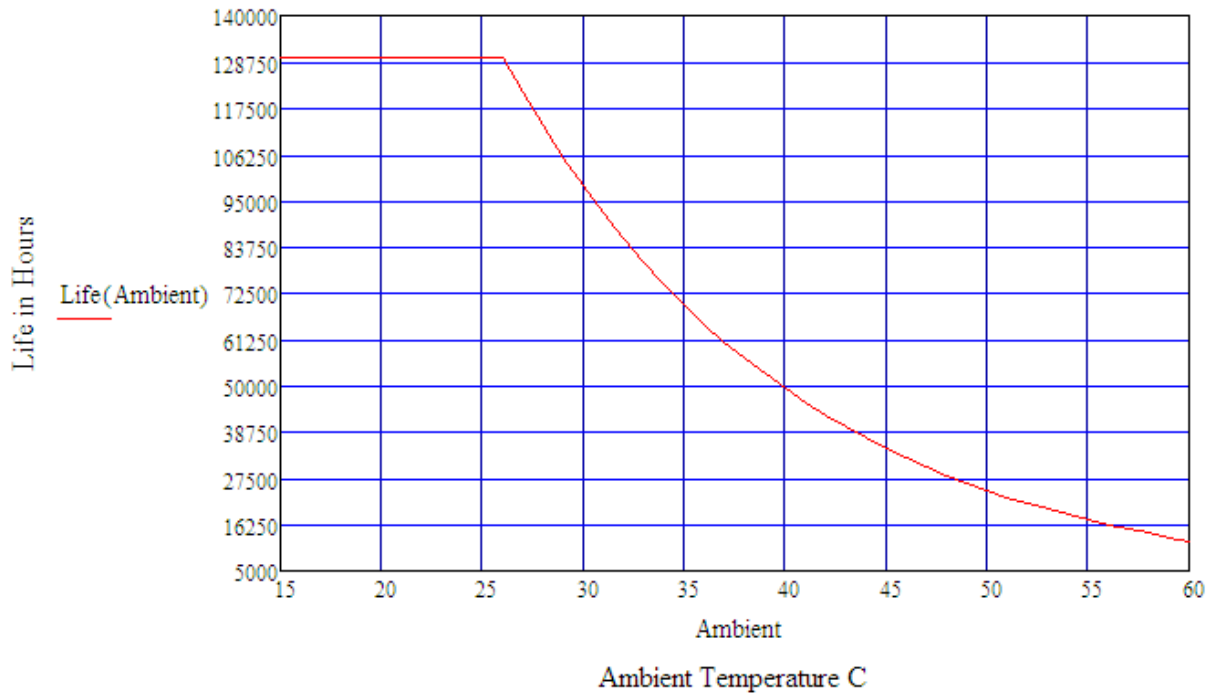

Life vs. Case (Tc) Temperature

LD30W Estimated Life Full Load @ 120Vac

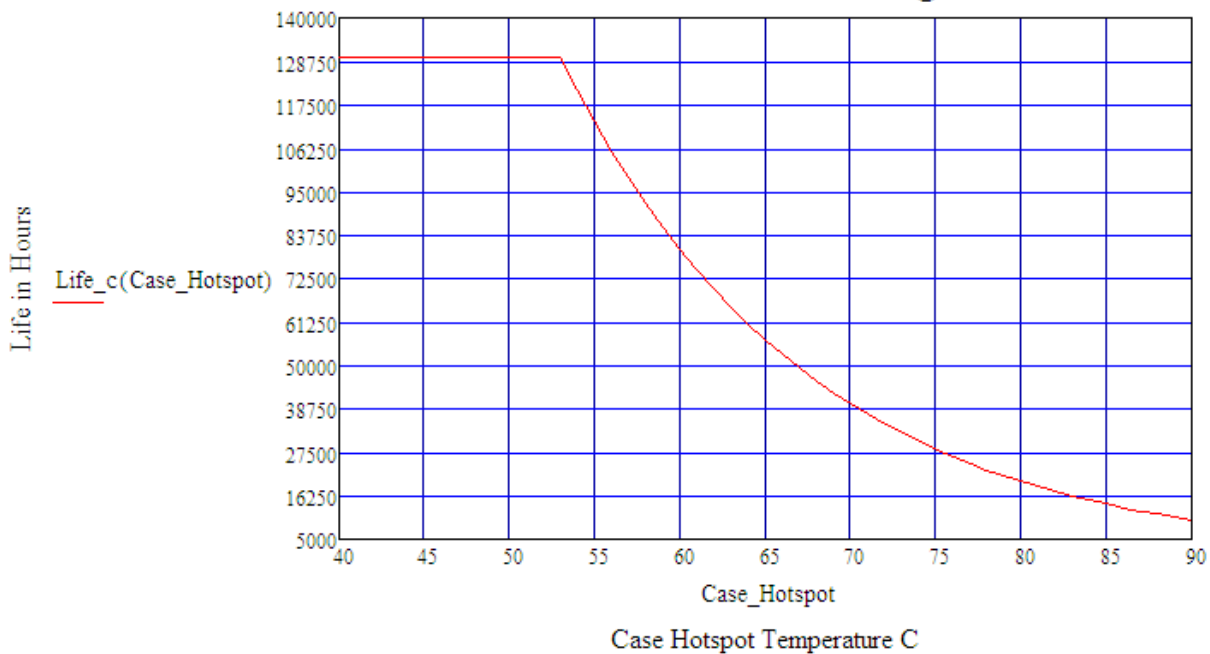

30W

LD30W Series

DIMMING



LED Optimized Drivers

30 Watt- LD30W Series

CONSTANT CURRENT LED DRIVER WITH DIMMING & DIM TO ZERO

Revision History

REV - Change Date	Description of Changes		
	Items	Changed From	Changed To
REV F - 11/01/2020	Initial spec release	REV A1.2	REV F
REV F - 06/18/2021	DIM Wire Colors	PURPLE/GREY	VIOLET/PINK, per NEMA 100