

# L200CUB500-3.8V

## Super Blue

5mm, Flanged Cylindrical, 8.6mm Height  
12° viewing angle

DWG BY:  
BL / GP  
06-13-07

CHK BY:  
PL  
08-06-07

QA:  
\_\_\_\_\_  
\_\_-\_\_-\_\_

MFG:  
\_\_\_\_\_  
\_\_-\_\_-\_\_

REVISION LTR: -

08-06-07

● **Features:**

1. Chip material: InGaN
2. Emitted color : Super Blue
3. Lens Appearance : Water Clear
4. Low power consumption.
5. High efficiency.
6. Versatile mounting on P.C. Board or panel.
7. Low current requirement.
8. 5mm diameter package.
9. This product is RoHS compliant.

● **Applications:**

1. TV set
2. Monitor
3. Telephone
4. Computer
5. Circuit board

● **Package dimensions:**

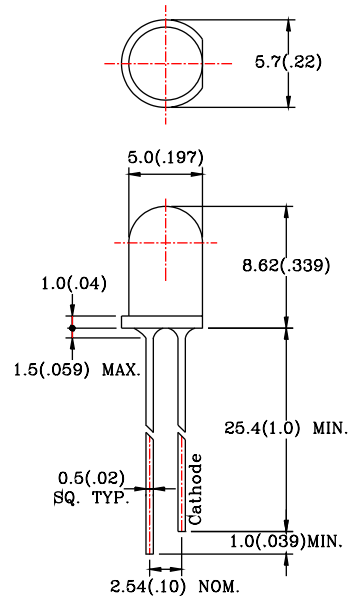

Notes:

1. All dimensions are in millimeters (inches).
2. Tolerance is  $\pm 0.25$ mm (0.01") unless otherwise specified.
3. Lead spacing is measured where the leads emerge from the package.
4. Specifications are subject to change without notice.

● **Absolute Maximum Ratings(Ta=25°C)**

Parameter	Symbol	Rating	Unit
Power Dissipation	Pd	120	mW
Forward Current	I <sub>F</sub>	30	mA
Peak Forward Current* <sup>1</sup>	I <sub>FP</sub>	150	mA
Reverse Voltage	V <sub>R</sub>	5	V
Operating Temperature	Topr	-40°C~80°C	
Storage Temperature	Tstg	-40°C~85°C	
Soldering Temperature	Tsol	260°C (for 5 seconds)	

\*<sup>1</sup>Condition for I<sub>FP</sub> is pulse of 1/10 duty and 0.1msec width.

● **Electrical and optical characteristics(Ta=25°C)**

Parameter	Symbol	Condition	Min.	Typ.	Max.	Unit
Forward Voltage	V <sub>F</sub>	I <sub>F</sub> =20mA	-	3.9	4.5	V
Luminous Intensity	I <sub>v</sub>	I <sub>F</sub> =20mA	-	250	-	mcd
Reverse Current	I <sub>R</sub>	V <sub>R</sub> =5V	-	-	100	μA
Peak Wave Length	λ <sub>p</sub>	I <sub>F</sub> =20mA	-	426	-	nm
Dominant Wave Length	λ <sub>d</sub>	I <sub>F</sub> =20mA	-	462	-	nm
Spectral Line Half-width	Δλ	I <sub>F</sub> =20mA	-	60	-	nm
Viewing Angle	2θ <sub>1/2</sub>	I <sub>F</sub> =20mA	-	12	-	deg
Radiant Intensity		I <sub>F</sub> =20mA	-	5500	-	μW/sr
Chromaticity Coordinates	X	I <sub>F</sub> =20mA	-	0.15	-	
	Y		-	0.06	-	

● **Typical electro-optical characteristics curves**

Fig.1 Relative intensity vs. Wavelength

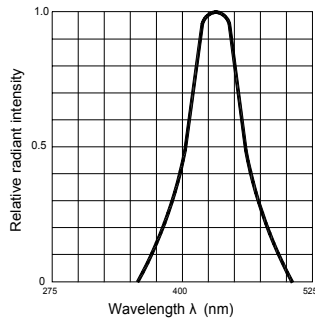

Fig.2 Forward current derating curve vs. Ambient temperature

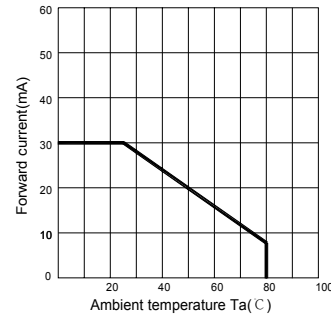

Fig.3 Forward current vs. Forward voltage

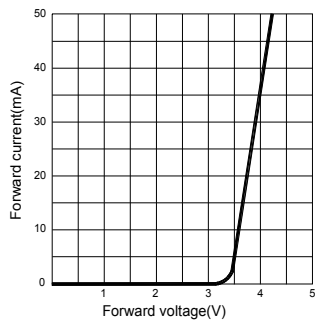

Fig.4 Relative luminous intensity vs. Ambient temperature

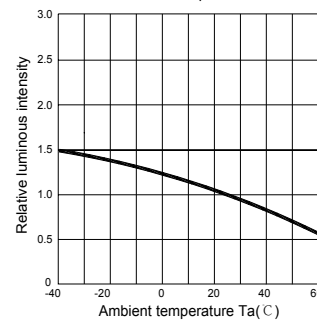

Fig.5 Relative luminous intensity vs. Forward current

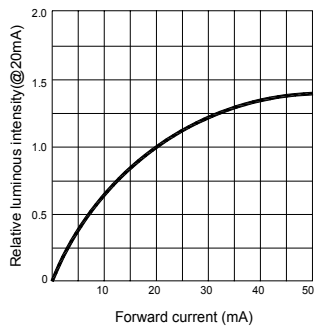
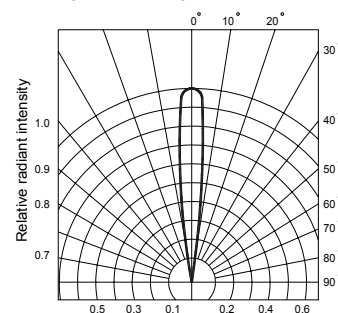

Fig.6 Radiation diagram



● **Bin Limits**

1. Intensity bin limits (At  $I_F=20\text{mA}$ )

<b>Bin Code</b>	<b>Min. (mcd)</b>	<b>Max. (mcd)</b>
M	28	42
N	42	63
P	63	94
Q	94	140
R	140	210

2.  $V_F$  Bin Limits (At  $I_F=20\text{mA}$ )

<b>Bin Code</b>	<b>Min. (v)</b>	<b>Max. (v)</b>
J	3.2	3.4
K	3.4	3.6
L	3.6	3.8
M	3.8	4.0

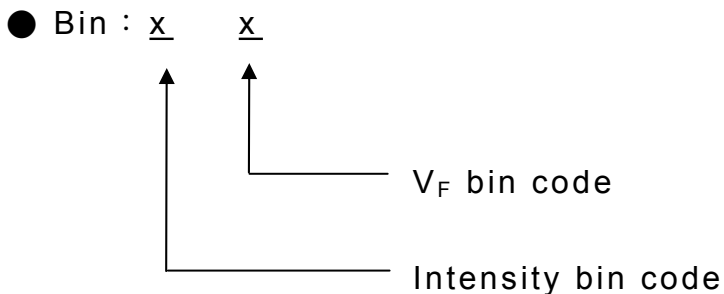

- NOTES: 1. Tolerance of measurement of luminous intensity. :±15%  
 2. Tolerance of measurement of forward voltage :±0.05V