

# SML10AG3KH-TR

Aqua Green

Surface Mount LED

3.2 × 1.6 × 1.1 mm Chip LED

120° viewing angle

DWG BY:  
BL / GP  
10-11-06

CHK BY:  
PL  
10-11-06

QA:  
\_\_  
10-\_\_-06

MFG:  
\_\_  
\_\_-\_\_-\_\_

REVISION LTR: -  
10-11-06

● **Features:**

1. Emitted Color : Aqua Green
2. Lens Appearance: Water Clear
3. Mono-color type.
4. 3.2x1.6x1.1mm(1206) standard package.
5. Suitable for all SMT assembly methods.
6. Compatible with infrared and vapor phase reflow solder process
7. Compatible with automatic placement equipment.

● **Applications:**

1. Automotive : Dashboards, stop lamps, turn signals.
2. Backlighting : LCDs, Key pads advertising.
3. Status indicators : Consumer & industrial electronics.
4. General use.

● **Package Dimensions:**

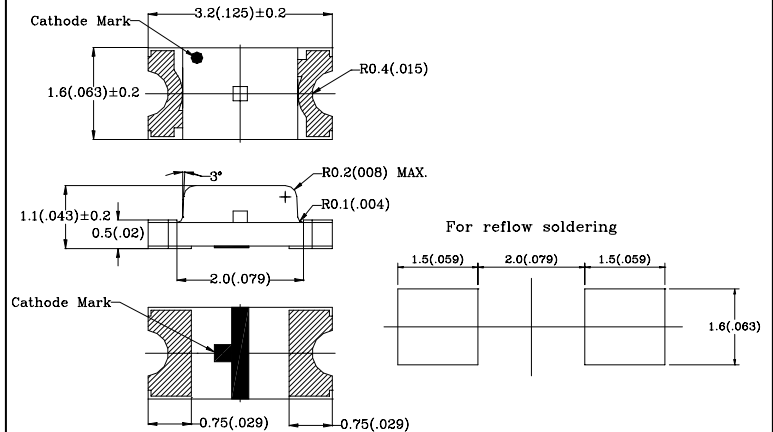

NOTES:

1. All dimensions are in millimeters (inches).
2. Tolerance is ±0.10mm (0.004") unless otherwise specified.
3. Specifications are subject to change without notice.

● **Absolute Maximum Ratings (Ta=25 °C)**

Parameter	Symbol	Rating	Unit
Power Dissipation	Pd	120	mW
Forward Current	I <sub>F</sub>	30	mA
Peak Forward Current * 1	I <sub>FP</sub>	100	mA
Reverse Voltage	V <sub>R</sub>	5	V
Operating Temperature	T <sub>opr</sub>	-25°C ~80°C	-
Storage Temperature	T <sub>stg</sub>	-30°C ~85°C	-
Soldering Temperature	T <sub>sol</sub>	See Page 6	-

\* 1 Condition for I<sub>FP</sub> is pulse of 1/10 duty and 0.1msec width.

● **Electrical and optical characteristics(Ta=25°C)**

Parameter	Symbol	Condition	Min.	Typ.	Max.	Unit
Forward Voltage	V <sub>F</sub>	I <sub>F</sub> =20mA	-	3.2	3.5	V
Luminous Intensity	I <sub>v</sub>	I <sub>F</sub> =20mA	-	300	-	mcd
Reverse Current	I <sub>R</sub>	V <sub>R</sub> =5V	-	-	100	μA
Peak Wave Length	λ <sub>p</sub>	I <sub>F</sub> =20mA	-	521	-	nm
Dominant Wave Length	λ <sub>d</sub>	I <sub>F</sub> =20mA	-	528	-	nm
Spectral Line Half-width	Δλ	I <sub>F</sub> =20mA	-	39	-	nm
Viewing Angle	2θ <sub>1/2</sub>	I <sub>F</sub> =20mA	-	120	-	deg
Radiant Intensity		I <sub>F</sub> =20mA	-	-	-	μW/sr
Chromaticity Coordinates	X	I <sub>F</sub> =20mA	-	0.19	-	
	Y		-	0.70	-	

● **Typical Electro-Optical Characteristics Curves**

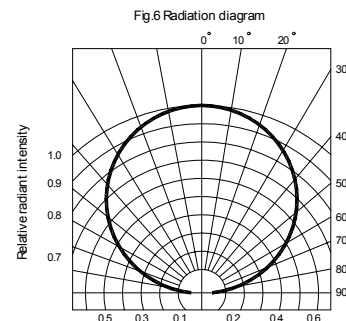
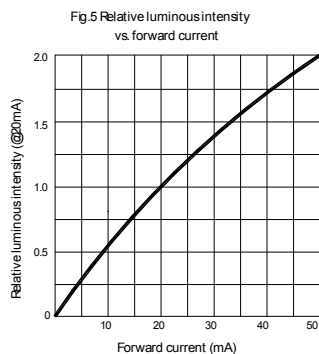
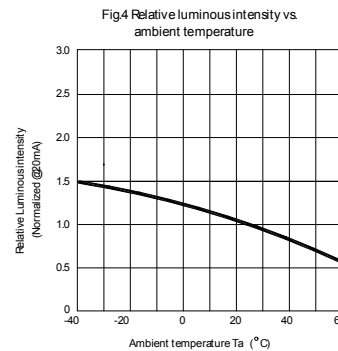
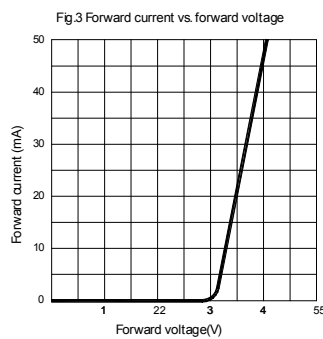
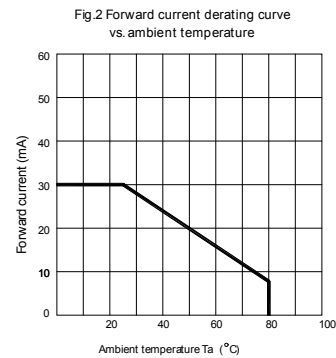
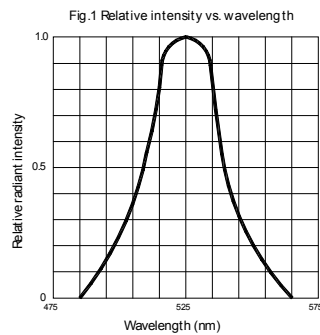

● **Tape and reel packaging specifications(Units: mm)**

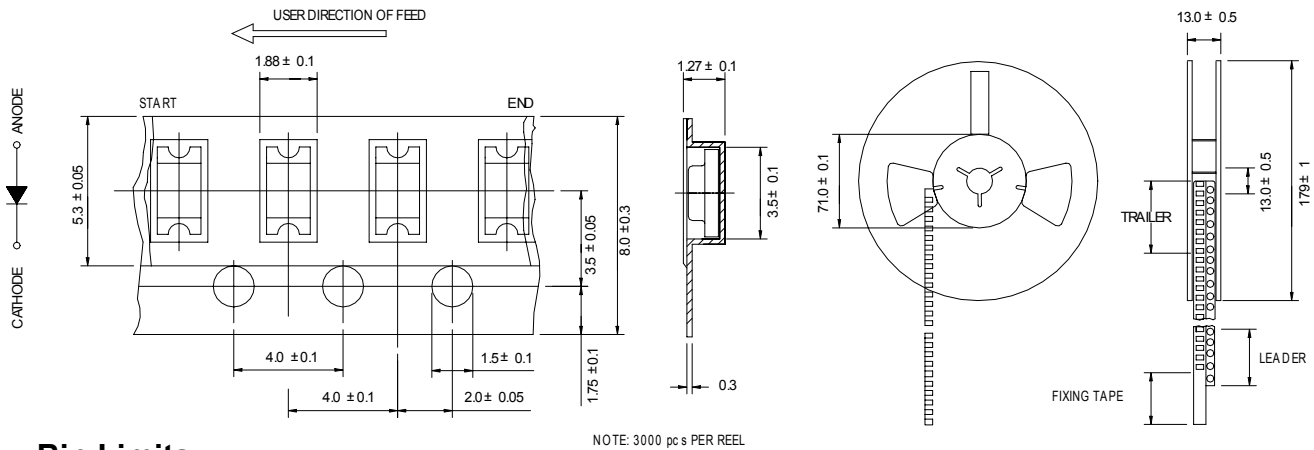

● **Bin Limits**

Intensity Bin Limits (At 20mA)

BIN CODE	Min. (mcd)	Max. (mcd)
Q	82.0	160.0
R	120.0	240.0
S	180.0	360.0
T	280.0	550.0

Color Bin Limits (At 20mA)

BIN CODE	Min. (nm)	Max. (nm)
6	519	526
7	524	531

V<sub>F</sub> Bin Limits (At 20mA)

BIN CODE	Min.(v)	Max.(v)
H	2.95	3.25
J	3.15	3.45
K	3.35	3.65
L	3.55	3.85
M	3.75	4.05

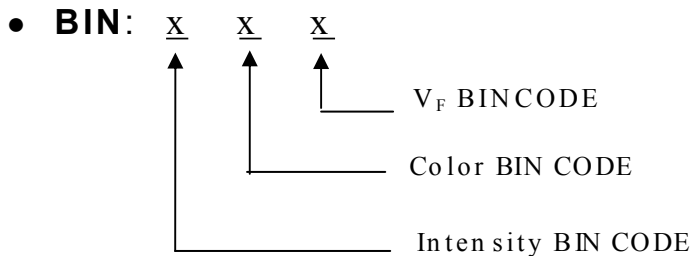

● **Reliability Test**

Classification	Test Item	Reference Standard	Test Conditions	Result
Endurance Test	OperationLife	MIL-STD-750:1026 MIL-STD-883:1005 JIS-C-7021 :B-1	Connect with a power $I_f=20\text{mA}$ $T_a$ =Under room temperature Test time=1,000hrs	0/20
	High Temperature High Humidity Storage	MIL-STD-202:103B JIS-C-7021 :B-11	$T_a=+65^\circ\text{C} \pm 5^\circ\text{C}$ RH=90%-95% Test time=240hrs	0/20
	High Temperature Storage	MIL-STD-883:1008 JIS-C-7021 :B-10	High $T_a=+85^\circ\text{C} \pm 5^\circ\text{C}$ Test time=1,000hrs	0/20
	Low Temperature Storage	JIS-C-7021 :B-12	Low $T_a=-35^\circ\text{C} \pm 5^\circ\text{C}$ Test time=1,000hrs	0/20
Environmental Test	Temperature Cycling	MIL-STD-202:107D MIL-STD-750:1051 MIL-STD-883:1010 JIS-C-7021 :A-4	$-35^\circ\text{C} \sim +25^\circ\text{C} \sim +85^\circ\text{C} \sim +25^\circ\text{C}$ 60min 20min 60min 20min Test Time=5cycle	0/20
	ThermalShock	MIL-STD-202:107D MIL-STD-750:1051 MIL-STD-883:1011	$-35^\circ\text{C} \pm 5^\circ\text{C} \sim +85^\circ\text{C} \pm 5^\circ\text{C}$ 20min 20min Test Time=10cycle	0/20
	Solder Resistance	MIL-STD-202:201A MIL-STD-750:2031 JIS-C-7021 :A-1	Preheating : 140°C -160°C ,within 2 minutes. Operation heating : 235°C (Max.), within 10seconds.(Max.)	0/20

● **Judgment criteria of failure for reliability**

Measuring items	Symbol	Measuring conditions	Judgement criteria for failure
Forwardvoltage	$V_F$ (V)	$I_F=20\text{mA}$	Over $U_{x12}$
Reverse current	$I_R$ ( $\mu\text{A}$ )	$V_R=5\text{V}$	Over $U_{x2}$
Luminous intensity	$I_v$ (mcd)	$I_F=20\text{mA}$	Below $SX0.5$

Note: 1. U means the upper limit of specified characteristics. S means initial value.

2. Measurement shall be taken between 2 hours and after the test pieces have been returned to normal ambient conditions after completion of each test.

● **Soldering :**

1. Manual Of Soldering

The temperature of the iron tip should not be higher than 300°C (572°F) and Soldering within 3 seconds per solder-land is to be observed.

2. Reflow Soldering

Preheating : 140°C ~160°C ±5°C ,within 2 minutes.

Operation heating :235°C (Max.)within 10 seconds.(Max)

Gradual Cooling (Avoid quenching).

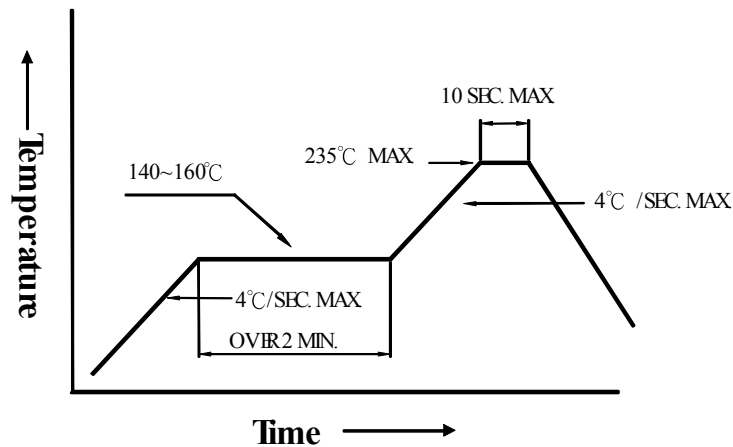

3. DIP soldering (Wave Soldering):

Preheating : 120°C~150°C , within 120~180 sec

Operation heating :245°C ± 5°C within 5 sec. 260°C (Max)

Gradual Cooling ( Avoid quenching).

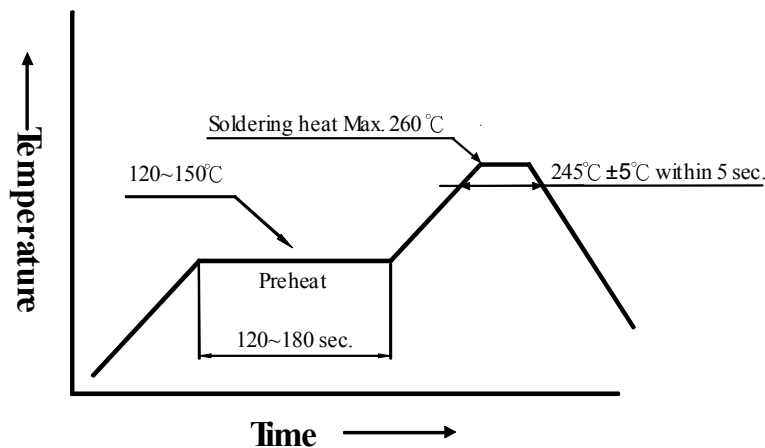

● **Handling :**

Care must be taken not to cause damage to the epoxy resin portion of LEDs while it is exposed to high temperatures, or abrade the epoxy resin portion of LEDs with hard or sharp items as from sand blasting and the use of sharp metallic objects.