



MBR2020 THRU MBR20100

SCHOTTKY BARRIER RECTIFIER

Reverse Voltage - 20 to 100 Volts Forward Current - 20.0 Amperes

TO-220AC

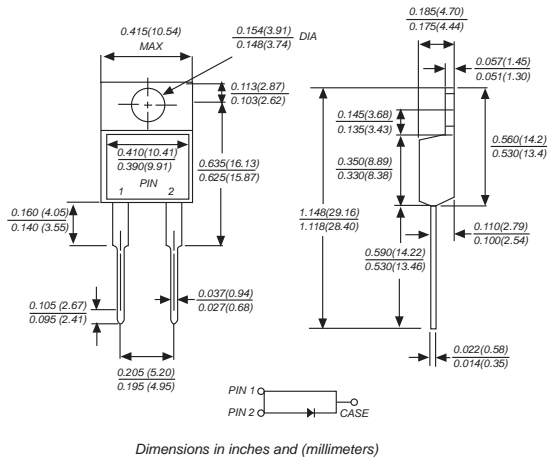

FEATURES

- ◆ The plastic package carries Underwriters Laboratory Flammability Classification 94V-0
- ◆ Construction utilizes void-free molded plastic technique
- ◆ Low reverse leakage
- ◆ High forward surge current capability
- ◆ High temperature soldering guaranteed: 250°C, 0.25" (6.35mm) from case for 10 seconds

MECHANICAL DATA

Case: TO-220AC molded plastic body
Terminals: Leads solderable per MIL-STD-750, Method 2026
Polarity: As marked
Mounting Position: Any
Weight: 0.064 ounce, 1.81 grams

MAXIMUM RATINGS AND ELECTRICAL CHARACTERISTICS

Ratings at 25°C ambient temperature unless otherwise specified.
 Single phase half-wave 60Hz, resistive or inductive load, for capacitive load current derate by 20%.

MDD Catalog Number	SYMBOLS	MBR 2020	MBR 2030	MBR 2040	MBR 2045	MBR 2050	MBR 2060	MBR 2070	MBR 2080	MBR 2090	MBR 20100	UNITS
Maximum repetitive peak reverse voltage	V_{RRM}	20	30	40	45	50	60	70	80	90	100	VOLTS
Maximum RMS voltage	V_{RMS}	14	21	28	32	35	42	49	56	63	70	VOLTS
Maximum DC blocking voltage	V_{DC}	20	30	40	45	50	60	70	80	90	100	VOLTS
Maximum average forward rectified current at T_c (see fig.1)	I_{AV}	20.0										Amps
Peak forward surge current 8.3ms single half sine-wave superimposed on rated load (JEDEC Method)	I_{FSM}	150.0										Amps
Maximum instantaneous forward voltage at 10.0A	V_F	0.55			0.75		0.85					Volts
Maximum DC reverse current at rated DC blocking voltage	I_R	15.0		50.0		1.0						mA
Typical junction capacitance (NOTE 1)	C_J	550			450						pF	
Typical thermal resistance (NOTE 2)	$R_{\theta JC}$	2.0										°C/W
Operating junction temperature range	T_J	-50 to +125				-50 to +150						°C
Storage temperature range	T_{STG}	-50 to +150										°C

Note: 1. Measured at 1MHz and applied reverse voltage of 4.0V D.C.

2. Thermal resistance from junction to case



www.mikrocode.com

RATINGS AND CHARACTERISTIC CURVES MBR2020 THRU MBR20100

AVERAGE FORWARD RECTIFIED CURRENT,
AMPERES

FIG. 1- FORWARD CURRENT DERATING CURVE

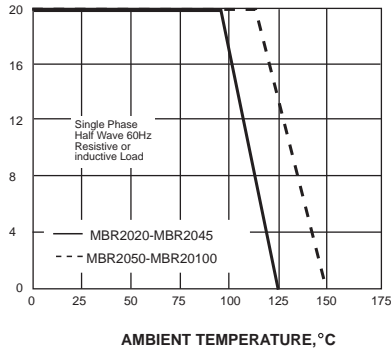

PEAK FORWARD SURGE CURRENT,
AMPERES

FIG. 2-MAXIMUM NON-REPETITIVE PEAK FORWARD SURGE CURRENT

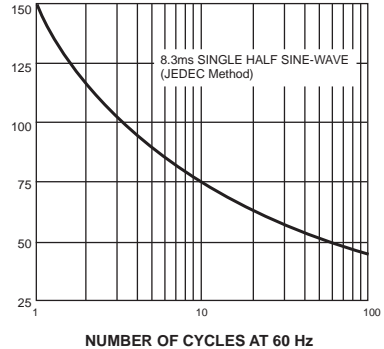

INSTANTANEOUS FORWARD CURRENT, AMPERES

FIG. 3-TYPICAL INSTANTANEOUS FORWARD CHARACTERISTICS

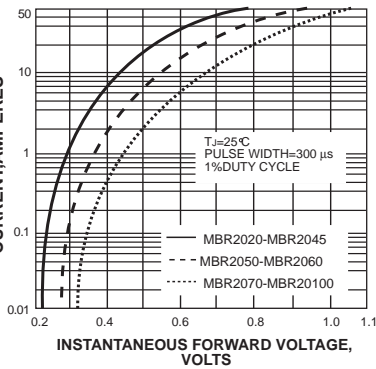

INSTANTANEOUS REVERSE CURRENT,
MILLIAMPERES

FIG. 4-TYPICAL REVERSE CHARACTERISTICS

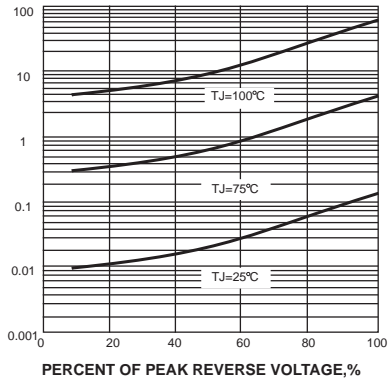

JUNCTION CAPACITANCE, pF

FIG. 5-TYPICAL JUNCTION CAPACITANCE

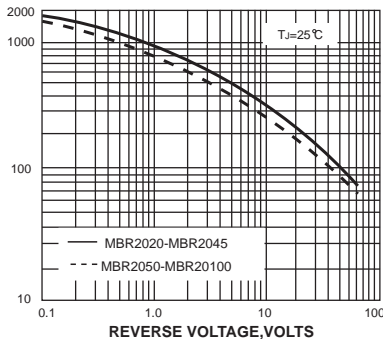

TRANSIENT THERMAL IMPEDANCE,
°C/W

FIG. 6-TYPICAL TRANSIENT THERMAL IMPEDANCE

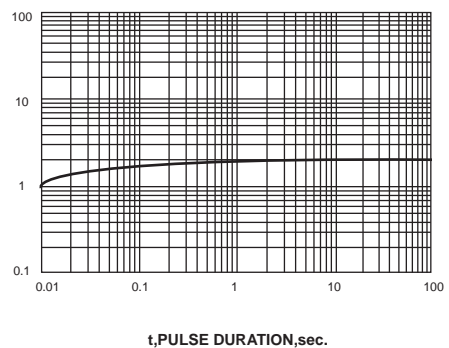

The cruve graph is for reference only, can't be the basis for judgment(曲线图仅供参考!)

