

12000X778 series

High performance toggle switches •
threaded bushing Ø 11.9 mm



DISTINCTIVE FEATURES

CECC approved - conforms to MIL specifications

Highly reliable contacts

Pinned lever

Double shell case for high mechanical strength and high electrical insulation

Compact size



ELECTRICAL SPECIFICATIONS

- Max. current/voltage rating with resistive load: 4 A 28 VDC
- Minimum load: 10 mA 50 mV, 10 μ A 5 VDC
When used above 300 mA 28 VDC, the gold plating is removed on contact areas and is considered only as a protection against oxidation during storage.
- Initial contact resistance: 10 m Ω max.
- Insulation resistance: 1,000 M Ω min. at 500 VDC
- Dielectric strength:
1,000 Vrms 50 Hz min. between terminals
2,000 Vrms 50 Hz min. between poles
2,000 Vrms 50 Hz min. between terminals and frame
- Contact bounce: 2 ms max.
- Electrical life:
 - At 4 A 28 VDC : 20,000 cycles (10,000 for functions 5, 4-1R, 4-2R)
 - At low level (50 mV 10 mA):
150,000 cycles (switches with 2 maintained positions)
100,000 cycles (switches with 3 maintained positions)
50,000 cycles (momentary functions 7, 8, 4-1R, 4-2R, 5)

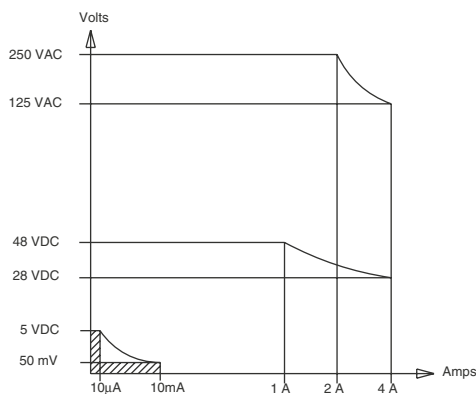

The company reserves the right to change specifications without notice.



12000X778 series

High performance toggle switches • threaded bushing Ø 11.9 mm



ENVIRONMENTAL SPECIFICATIONS

- Shock test: 50 g - 11 ms (IEC 68-2-27)
- Vibrations: 10-500 Hz - 10g (IEC68-2-6)
- Humidity test: 56 days, 93 % R.H., 40 °C (IEC 68-2-3)
- Salt spray test: 96 hours (IEC 68-2-11)
- Operating temperature: -40 °C to +85 °C (-40 °F to +185 °F)



GENERAL SPECIFICATIONS

- Torque: 1.50 Nm (1.10 Ft.lb) max. applied to nut
- Panel thickness: 8 mm (.314) max. - 3 mm (.118) min.



SEALING

- Front panel sealing by two O-rings
Flatted bush for precise orientation
- Panel seal withstands 1 bar pressure and remains sealed even when the switch is operated.
- Epoxy sealed terminals
- Splash-proof case

→ FLAT

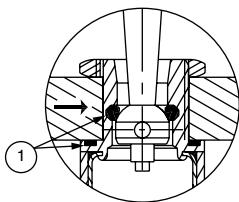

① - O-rings

AGENCY APPROVALS



CECC 96201-005
CECC 96201-008

Designed to MIL specifications

Availability : consult factory for details of approved models.
Marking : to order switches marked CECC, complete appropriate box of ordering format.



MATERIALS

- Case: diallyphthalate (DAP) with plastic external shell (epoxy sealed)
- Actuator: brass, black chrome plated
- Bushing: brass, black chrome plated
- Contacts: solid rivet - gold plated silver/nickel alloy

APEM products may be recycled at end-of-life for the re-claiming of valuable metal components.



TERMINALS

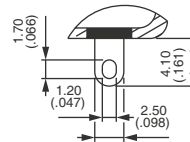

Solder lugs

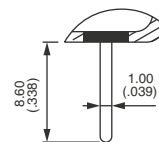

Straight PC



ELECTRICAL FUNCTIONS

→ FLAT

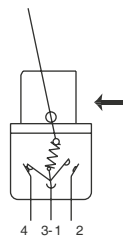

Function 6

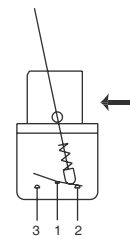

Other functions



PANEL CUT-OUT

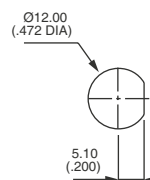

12000X778 series

High performance toggle switches • threaded bushing Ø 11.9 mm



BUILD YOUR PART NUMBER

BASIC PART NUMBER

12	—	—	—	—
SERIES	TERMINALS AND BUSHINGS	NUMBER OF POLES	ELECTRICAL FUNCTIONS	MOMENTARY FOR FUNCTION 4
	<p>1 Solder lug terminals</p> <p>2 Straight PC terminals</p> <p>All models with threaded bushing Ø 11.9 (15/32)</p>	<p>4 Double pole</p> <p>5 Three pole</p> <p>6 Four pole</p>	<p>6 ON - ON</p> <p>9 ON OFF ON</p> <p>7 MOM OFF MOM</p> <p>8 ON OFF MOM</p> <p>4 ON ON ON ON ON MOM Δ MOM ON MOM Δ</p> <p>5 - ON MOM</p> <p>Function 4 For 2 and 4 poles only. Δ Must not have blank in «momentary» box.</p>	<p>1R ON ON MOM</p> <p>2R MOM ON MOM</p> <p>For function 4 only. Leave blank for other functions.</p>

OPTIONS

—	—	—	—
FLUORESCENT TIP	LEVERS	X778	APPROVAL
<p>Blank None</p> <p>-038 White fluorescent tip to lever</p>	<p>Blank Standard lever</p> <p>-12 Short lever</p> <p style="text-align: center;">⋮</p> <p style="text-align: center;">LOCKING LEVERS</p> <p>-1V 1 locked position</p> <p>-2V 2 locked positions</p> <p>-3V 3 locked positions</p> <p>Other : see following pages.</p>	<p>High performance fully sealed black switches.</p>	<p>CECC Availability: Consult factory for details of approved models.</p>



ABOUT THIS SERIES

- ⚠ **Notice:** please note that not all combinations of above numbers are available. Refer to the following pages for further information.
- 💧 **Sealing boots** can be used to further protect the switches against dust and water. See "Sealing Boots" section of website.
- 🔩 **Mounting accessories:** standard hardware supplied with all models : 1 hex nut 14 mm (.551) across flats, part number U41.
- 🛡️ **Switch guards** are available to prevent inadvertent lever operation. See "Switch Guards" section of website.

12000X778 series

High performance toggle switches • threaded bushing Ø 11.9 mm

SOLDER LUG TERMINALS - DOUBLE POLE



BASIC P/N	Angle of throw (A)	I	II	III
12146 X778	26°	ON	-	ON
12149 X778	20°	ON	OFF	ON
12147 X778	20°	MOM	OFF	MOM
12148 X778	20°	ON	OFF	MOM
12144 X778	20°	ON	ON	ON
12144-1R X778	20°	MOM	ON	ON
12144-2R X778	20°	MOM	ON	MOM
12145 X778	12°	-	ON	MOM

SOLDER LUG TERMINALS - THREE POLE



BASIC P/N	Angle of throw (A)	I	II	III
12156 X778	26°	ON	-	ON
12159 X778	20°	ON	OFF	ON
12157 X778	20°	MOM	OFF	MOM
12158 X778	20°	ON	OFF	MOM

SOLDER LUG TERMINALS - FOUR POLE



BASIC P/N	Angle of throw (A)	I	II	III
12166 X778	26°	ON	-	ON
12169 X778	20°	ON	OFF	ON
12167 X778	20°	MOM	OFF	MOM
12168 X778	20°	ON	OFF	MOM
12164 X778	20°	ON	ON	ON
12164-1R X778	20°	ON	ON	MOM
12164-2R X778	20°	MOM	ON	MOM

STRAIGHT PC TERMINALS - DOUBLE POLE ▲



BASIC P/N	Angle of throw (A)	I	II	III
12246 X778	26°	ON	-	ON

→ FLAT

Shown with standard lever

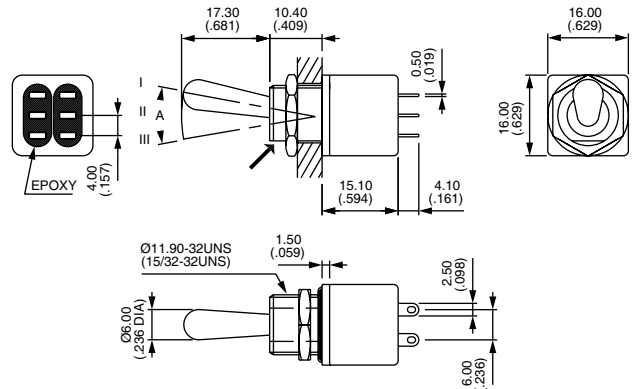

→ FLAT

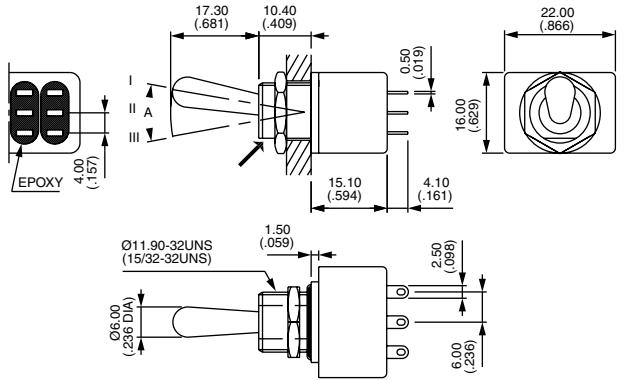

→ FLAT

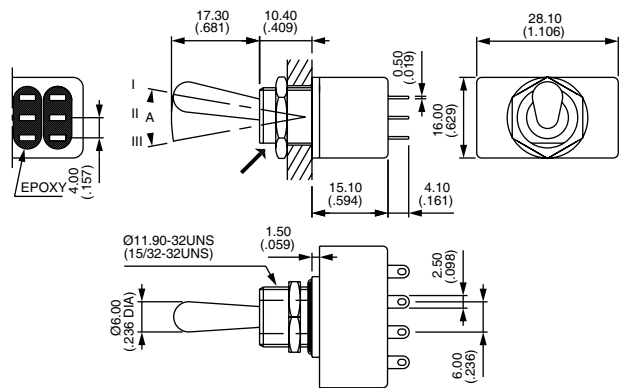

→ FLAT

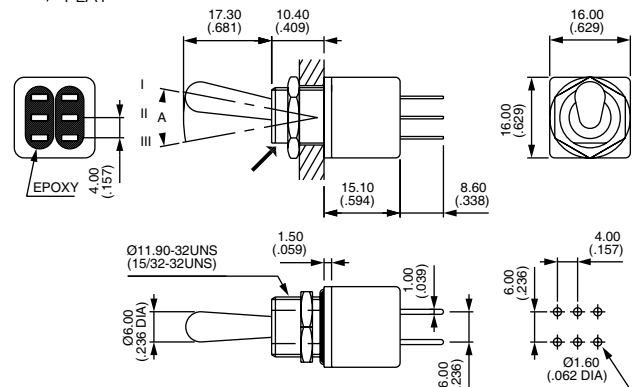

12000X778 series

High performance toggle switches • threaded bushing Ø 11.9 mm

STRAIGHT PC TERMINALS - THREE POLE ▲



BASIC P/N	Angle of throw (A)	I	II	III
12256 X778	26°	ON	-	ON

STRAIGHT PC TERMINALS - FOUR POLE ▲



BASIC P/N	Angle of throw (A)	I	II	III
12266 X778	26°	ON	-	ON

▲ 3.5 mm (.138) short terminals available on request for function 6. Standard for functions 9, 7, 8, 4 and 5.

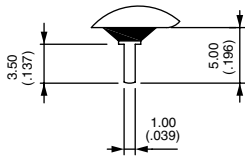

STANDARD HARDWARE - HEX NUT - U41 - BLACK

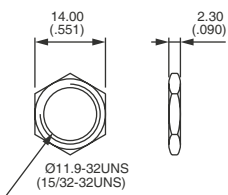

→ FLAT

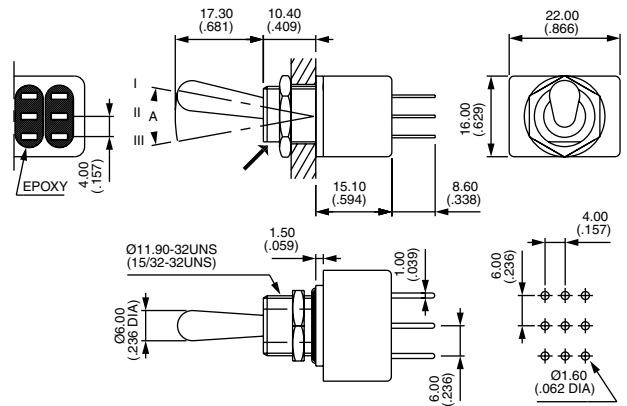

→ FLAT

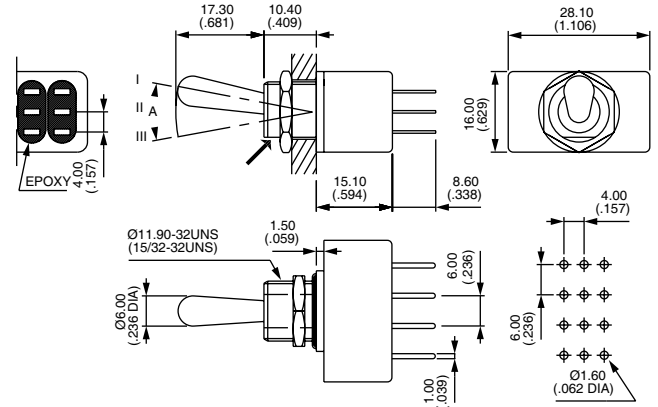

12000X778 series

High performance toggle switches • threaded bushing Ø 11.9 mm



POSITIONS AND CONNECTIONS

FUNCTION	LEVER POSITION AND CONNECTIONS			TERMINAL IDENTIFICATION	WIRING FOR 3-WAY SWITCHES (FUNCTION 4)
	I	II	III (FLAT)		
12146	ON (1-3)-4 (5-7)-8	-	ON (1-3)-2 (5-7)-6		<p>→EXTERNAL JUMPER (ADDED BY CUSTOMER)</p> <p>12144 </p> <p>12144-1R </p> <p>12144-2R </p>
12147 12148 12149 12148CT	MOM ON ON MOM	OFF OFF OFF OFF	MOM MOM ON ON	<p>→ FLAT</p>	
12145	-	ON	MOM		
12144 12144-1R 12144-2R	ON MOM MOM	ON ON ON	ON ON MOM		
	1-2 4-5	1-3 4-5	1-3 4-6		
12156	ON (1-3)-4 (5-7)-8 (9-11)-12	-	ON (1-3)-2 (5-7)-6 (9-11)-10		
12166	ON 1A - 3A 1C - 3C 1E - 3E 1G - 3G	-	ON 1A - 2A 1C - 2C 1E - 2E 1G - 2G		
12164	ON 1A - 2A 1C - 2C 1E - 2E 1G - 2G	ON 1A - 2A 1C - 3C 1E - 2E 1G - 3G	ON 1A - 3A 1C - 3C 1E - 3E 1G - 3G		
				<p>12164 </p>	

12000X778 series

High performance toggle switches • threaded bushing Ø 11.9 mm

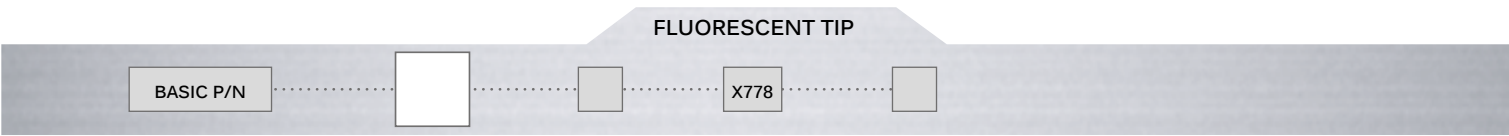

Blank None
038 White fluorescent tip. Becomes luminous when submitted to ultra-violet rays.

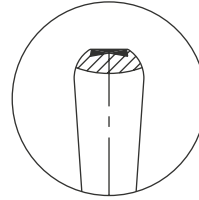

Standard lever

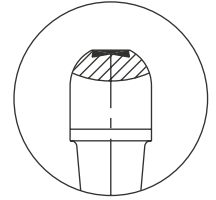

Locking lever

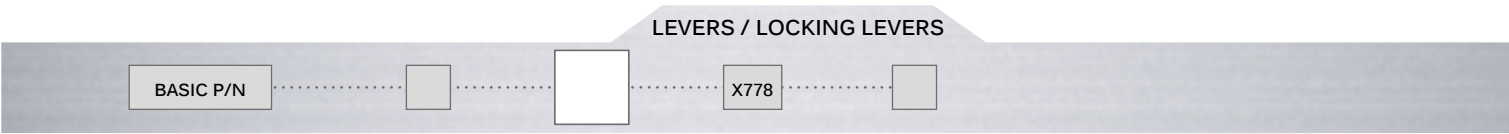

Dash compulsory before lever code.
 Switch guards and sealing boot: see "Switch Guards" and "Sealing boots" sections of website.

LEVERS

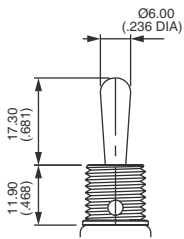

Blank Standard

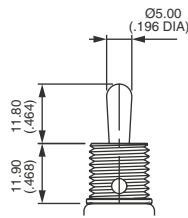

-12 Short lever

LOCKING LEVERS

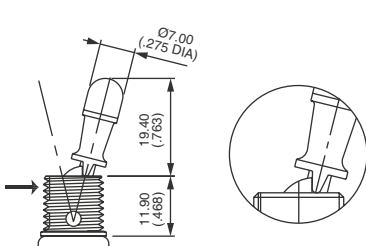

-1V
 1 locked position (function 6)
 Typical angle of throw : 26°

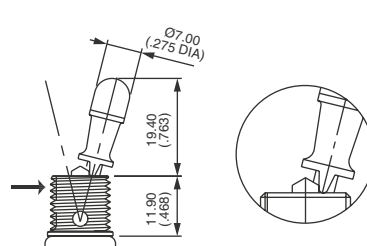

-2V
 2 locked positions (function 6)
 Typical angle of throw : 26°

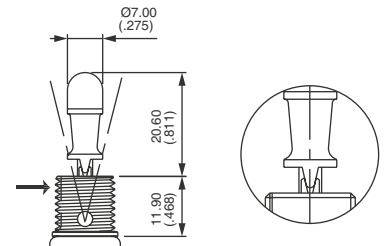

-3V
 3 locked positions (functions 9 and 4)
 Typical angle of throw : 20°

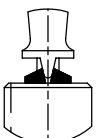

-4V
 Functions 9 & 4

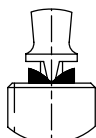

-5V
 Functions 7 & 442R

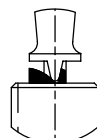

-7V
 Functions 8 & 441R

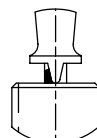

-8V
 Functions 8, 9, 44 & 441R

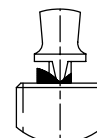

-9V
 Functions 8 & 441R

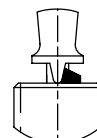

-11V
 Functions 8, 9, 44 & 441R

12000X778 series

High performance toggle switches • threaded bushing Ø 11.9 mm

LOCKING LEVERS (CONTINUED)

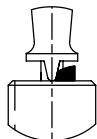

-12V
Functions 8 & 441R

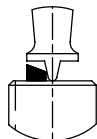

-13V
Funct. 8, 5 & 441R

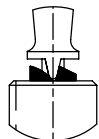

-15V
Functions 8 & 441R

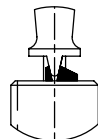

-16V
Functions 4 & 9

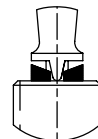

-17V
Functions 7 & 442R

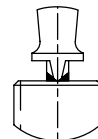

-20V
Functions 9 & 44

Note: -5V and -12V are not true locking levers: no pulling is required before actuation.

AGENCY APPROVAL



- CECC** CECC 96201-005 and CECC 96201-008
Availability: consult factory for details of approved models.
Marking: to order switches marked CECC, complete above box with "CECC".
- Blank** No agency approval required.