

Old P/N.:0800 Series

0.8mm Housing IDC / Wafer SMT Straight & SMT Right Angle Type

Specifications

Current Rating: 0.5A AC,DC
 Voltage Rating: 30V AC,DC
 Temperature Range: -25°C to +85°C
 Contact Resistance: 20mΩ Max
 Insulation Resistance: 100MΩ Min
 Withstanding Voltage: 200V AC/minute
 Terminal: Phosphor Bronze / Tin Plated
 Solder Tabs: Phosphor Bronze / Tin Plated
 Material: Housing: Nylon 46, UL94V-0
 Wafer: Nylon 6T, UL94V-0

No. of Contacts	Dimensions			No. of Contacts	Dimensions		
	A	B	C		A	B	C
2	0.80	2.40	3.20	10	7.20	8.80	9.60
3	1.60	3.20	4.00	12	8.80	10.40	11.20
4	2.40	4.00	4.80	14	10.40	12.00	12.80
5	3.20	4.80	5.60	15	11.20	12.80	13.60
6	4.00	5.60	6.40	16	12.00	13.60	14.40
7	4.80	6.40	7.20	17	12.80	14.40	15.20
8	5.60	7.20	8.00	20	15.20	16.80	17.60

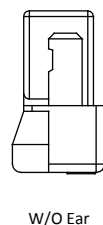
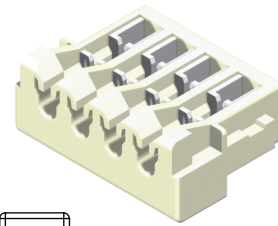
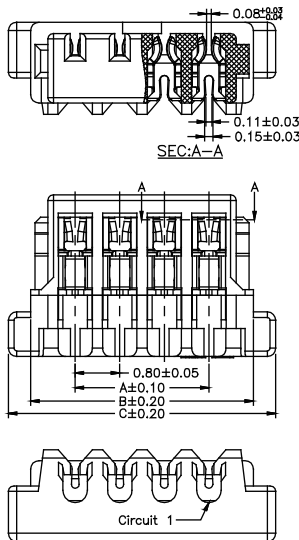

P/N.:5W0800DHX-XXT0WBU-01
 1:With Ear
 0:W/O Ear

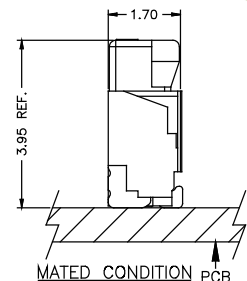
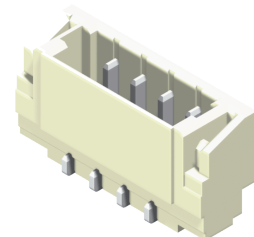
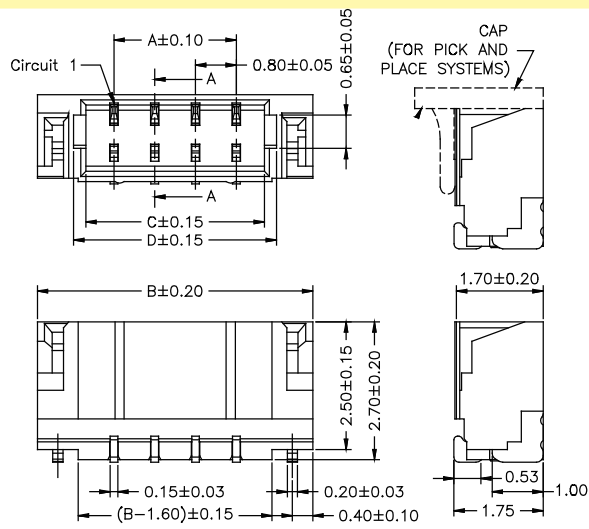
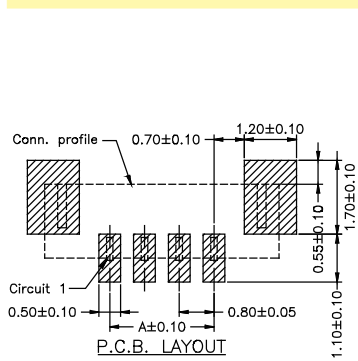

No. of Contacts	Dimensions			
	A	B	C	D
2	0.80	3.80	1.90	2.38
3	1.60	4.60	2.70	3.18
4	2.40	5.40	3.50	3.98
5	3.20	6.20	4.30	4.78
6	4.00	7.00	5.10	5.58
7	4.80	7.80	5.90	6.38
8	5.60	8.60	6.70	7.18
10	7.20	10.20	8.30	8.78
12	8.80	11.80	9.90	10.38
14	10.40	13.40	11.50	11.98
15	11.20	14.20	12.30	12.78
16	12.00	15.00	13.10	13.58
17	12.80	15.80	13.90	14.38
20	15.20	18.20	16.30	16.78

P/N.:5W0800G0-1XXT0WRU-01

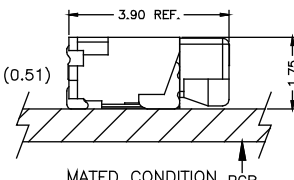
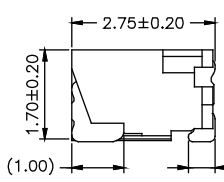
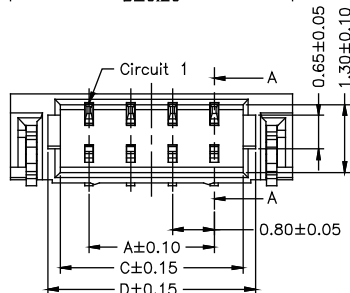
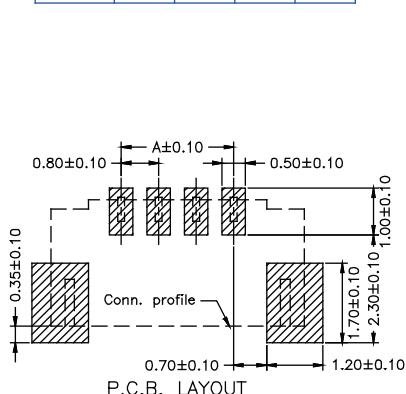
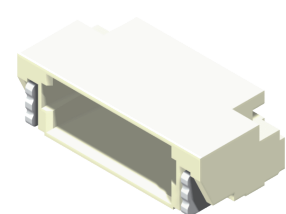
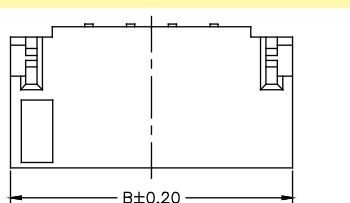

P/N.:5W0800H0-1XXT0WRU-01