



# 2N7002

## 60V N-Channel Enhancement Mode MOSFET

### FEATURES

- $R_{DS(ON)}, V_{GS} @ 10V, I_{DS} @ 500mA = 5\Omega$
- $R_{DS(ON)}, V_{GS} @ 4.5V, I_{DS} @ 75mA = 7.5\Omega$
- Advanced Trench Process Technology
- High Density Cell Design For Ultra Low On-Resistance
- Specially Designed for Battery Operated Systems, Solid-State Relays Drivers : Relays, Displays, Lamps, Solenoids, Memories, etc.
- Lead free in comply with EU RoHS 2011/65/EU directives
- Green molding compound as per IEC61249 Std. . (Halogen Free)

### MECHANICAL DATA

- Case : SOT-23 Package
- Terminals : Solderable per MIL-STD-750, Method 2026
- Approx. Weight : 0.0003 ounces, 0.008 grams
- Marking : S72

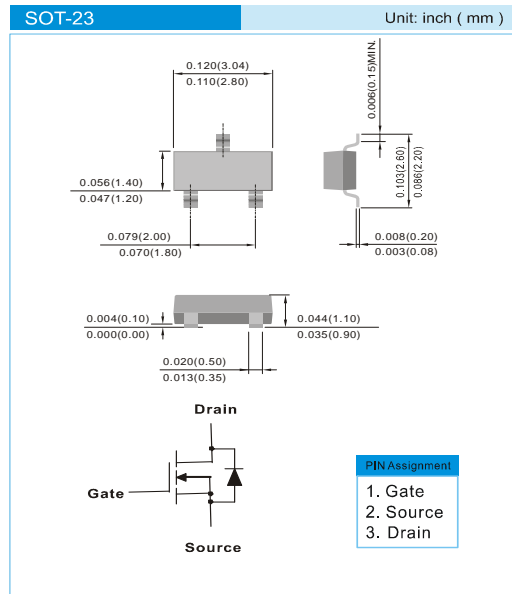

### Maximum Ratings and Thermal Characteristics ( $T_A = 25^\circ\text{C}$ unless otherwise noted )

PARAMETER	Symbol	Limit	Units
Drain-Source Voltage	$V_{DS}$	60	V
Gate-Source Voltage	$V_{GS}$	$\pm 20$	V
Continuous Drain Current	$I_D$	250	mA
Pulsed Drain Current <sup>1)</sup>	$I_{DM}$	1300	mA
Maximum Power Dissipation	$P_D$	$T_A = 25^\circ\text{C}$ 350 $T_A = 75^\circ\text{C}$ 210	mW
Operating Junction and Storage Temperature Range	$T_J, T_{STG}$	-55 to + 150	$^\circ\text{C}$
Junction-to Ambient Thermal Resistance(PCB mounted) <sup>2)</sup>	$R_{\theta JA}$	357	$^\circ\text{C}/\text{W}$

Note:1. Maximum DC current limited by the package  
2. Surface mounted on FR4 board,  $t \leq 10$  sec



# 2N7002

## ELECTRICAL CHARACTERISTICS

Parameter	Symbol	Test Condition	Min.	Typ.	Max.	Units
Static						
Drain-Source Breakdown Voltage	$BV_{DSS}$	$V_{GS}=0V, I_D=10\mu A$	60	-	-	V
Gate Threshold Voltage	$V_{GS(th)}$	$V_{DS}=V_{GS}, I_D=250\mu A$	1	-	2.5	V
Drain-Source On-State Resistance	$R_{DS(on)}$	$V_{GS}=4.5V, I_D=75mA$	-	-	7.5	$\Omega$
Drain-Source On-State Resistance	$R_{DS(on)}$	$V_{GS}=10V, I_D=500mA$	-	-	5	
Zero Gate Voltage Drain Current	$I_{DSS}$	$V_{DS}=60V, V_{GS}=0V$	-	-	1	$\mu A$
Gate Body Leakage	$I_{GSS}$	$V_{GS}=\pm 20V, V_{DS}=0V$	-	-	$\pm 100$	nA
Forward Transconductance	$g_{fs}$	$V_{DS}=15V, I_D=250mA$	200	-	-	mS
Dynamic						
Total Gate Charge	$Q_g$	$V_{DS}=15V, I_D=500mA$ $V_{DD}=4.5V$	-	0.6	0.7	nC
Gate-Source Charge	$Q_{gs}$		-	0.1	-	
Gate-Drain Charge	$Q_{gd}$		-	0.08	-	
Turn-On Time	$t_{on}$	$V_{DD}=10V, R_L=20\Omega$ $I_D=500mA, V_{GEN}=10V$ $R_G=10\Omega$	-	9	15	ns
Turn-Off Time	$t_{off}$		-	21	26	
Input Capacitance	$C_{iss}$	$V_{DS}=25V, V_{GS}=0V$ $f=1.0MHz$	-	-	50	pF
Output Capacitance	$C_{oss}$		-	-	25	
Reverse Transfer Capacitance	$C_{rss}$		-	-	5	
Source-Drain Diode						
Max. Diode Forward Current	$I_s$	-	-	-	250	mA
Diode Forward Voltage	$V_{SD}$	$I_s=250mA, V_{GS}=0V$	-	0.93	1.2	V

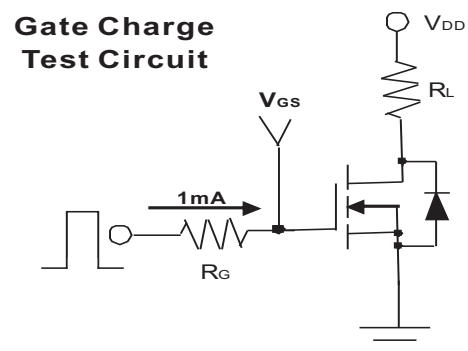
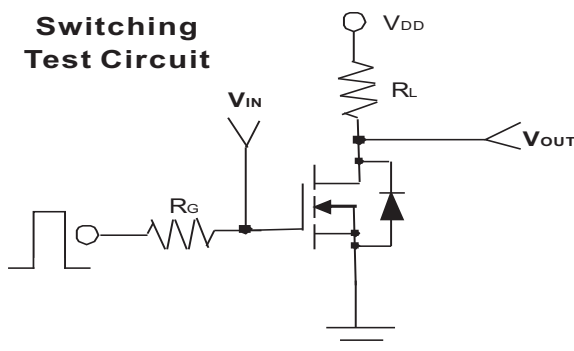



# 2N7002

Typical Characteristics Curves ( $T_A=25^\circ\text{C}$ , unless otherwise noted)

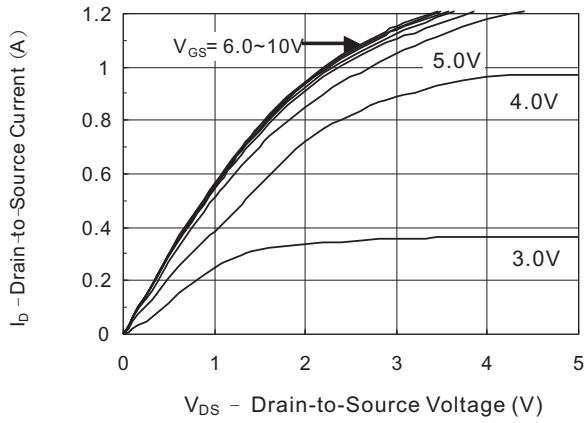

FIG.1- Output Characteristic

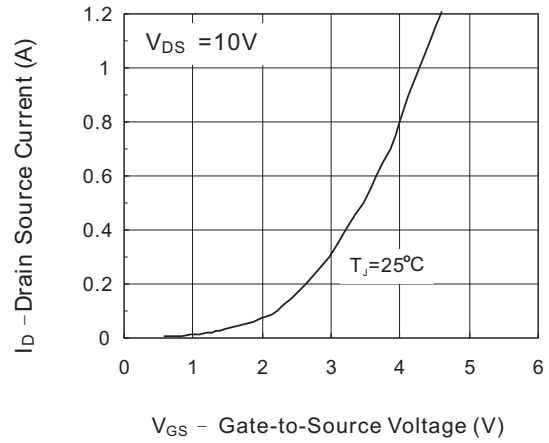

FIG.2- Transfer Characteristic

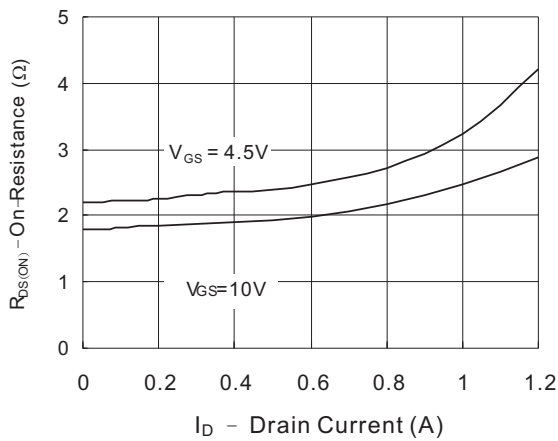

FIG.3- On Resistance vs Drain Current

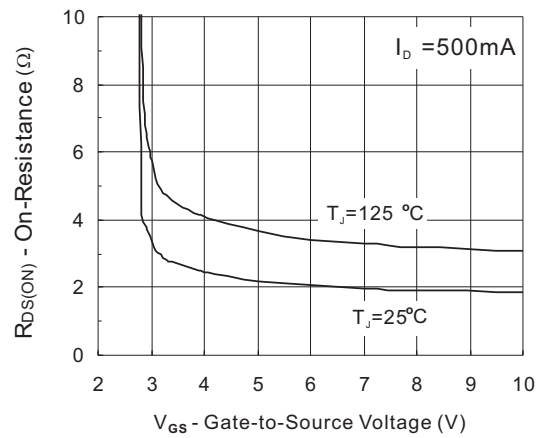

FIG.4- On Resistance vs Gate to Source Voltage

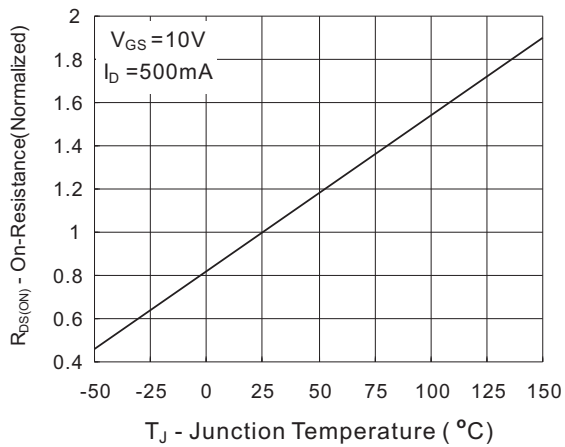

FIG.5- On Resistance vs Junction Temperature



# 2N7002

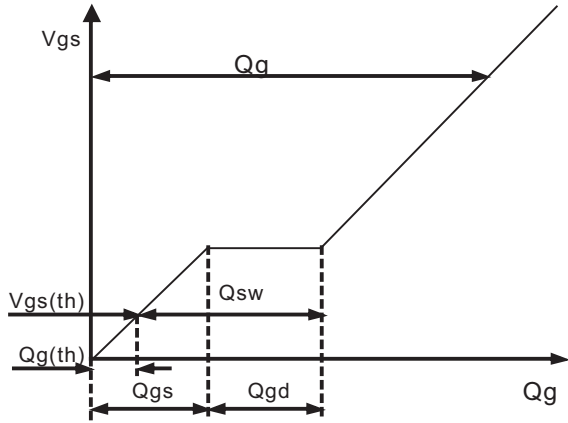

Fig.6 - Gate Charge Waveform

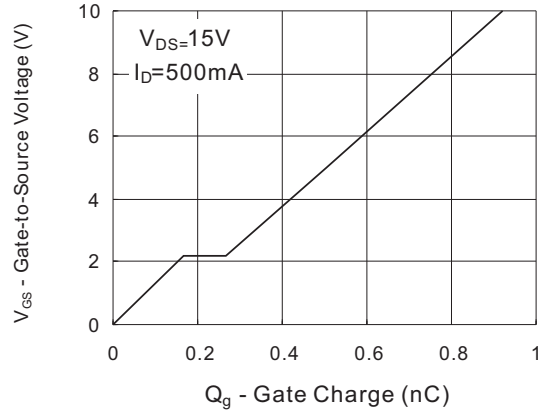

Fig.7 - Gate Charge

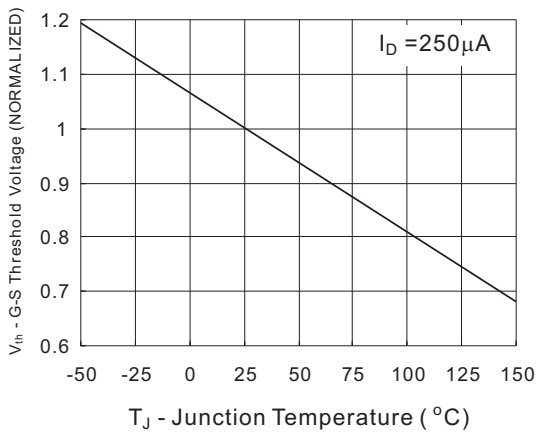

Fig.8 - Threshold Voltage vs Temperature

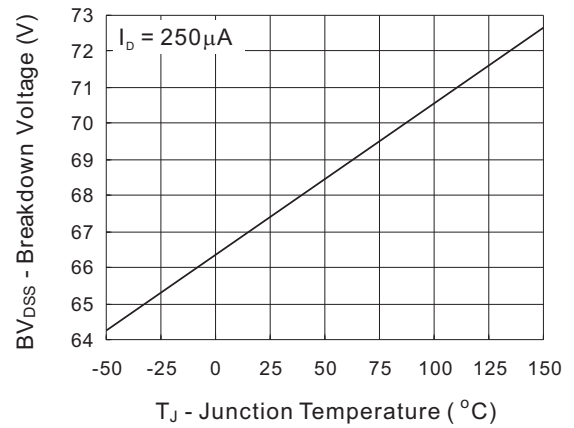

Fig.9 - Breakdown Voltage vs Junction Temperature

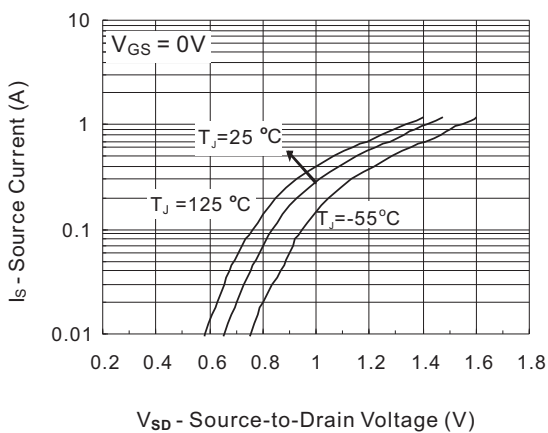

Fig.10 - Source-Drain Diode Forward Voltage

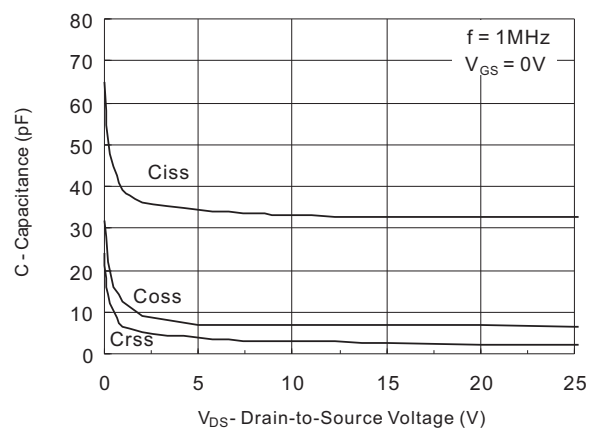

Fig.11 - Capacitance vs Drain to Source Voltage



# 2N7002

## MOUNTING PAD LAYOUT

**SOT-23**

Unit : inch(mm)

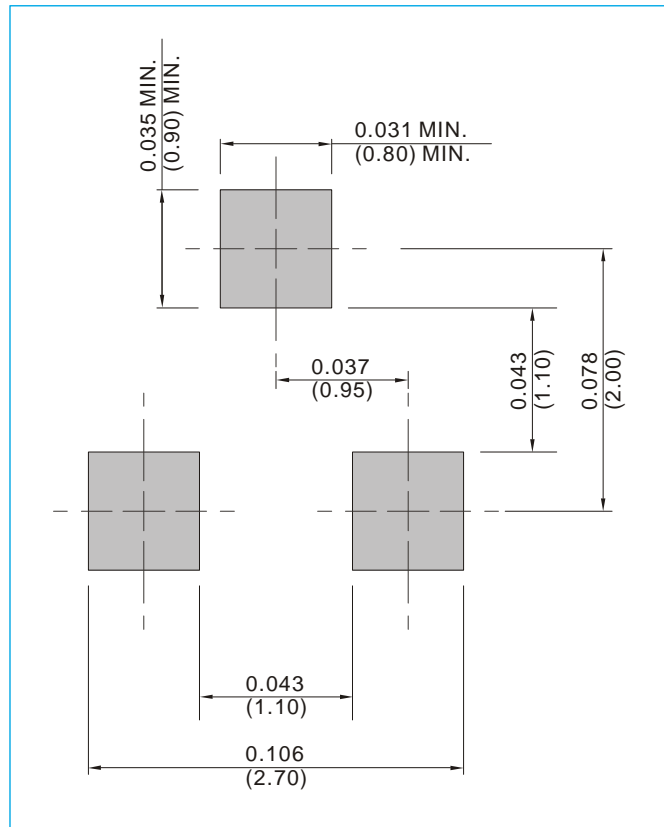

## ORDER INFORMATION

- Packing information
  - T/R - 12K per 13" plastic Reel
  - T/R - 3K per 7" plastic Reel



# 2N7002

## Part No\_packing code\_Version

2N7002\_R1\_00001

2N7002\_R2\_00001

For example :

**RB500V-40\_R2\_00001**



Packing Code XX				Version Code XXXXX		
Packing type	1 <sup>st</sup> Code	Packing size code	2 <sup>nd</sup> Code	HF or RoHS	1 <sup>st</sup> Code	2 <sup>nd</sup> ~5 <sup>th</sup> Code
Tape and Ammunition Box (T/B)	A	N/A	0	HF	0	serial number
Tape and Reel (T/R)	R	7"	1	RoHS	1	serial number
Bulk Packing (B/P)	B	13"	2			
Tube Packing (T/P)	T	26mm	X			
Tape and Reel (Right Oriented) (TRR)	S	52mm	Y			
Tape and Reel (Left Oriented) (TRL)	L	PANASERT T/B CATHODE UP (PBCU)	U			
FORMING	F	PANASERT T/B CATHODE DOWN (PBCD)	D			



## 2N7002

---

### Disclaimer

- Reproducing and modifying information of the document is prohibited without permission from Panjit International Inc..
- Panjit International Inc. reserves the rights to make changes of the content herein the document anytime without notification. Please refer to our website for the latest document.
- Panjit International Inc. disclaims any and all liability arising out of the application or use of any product including damages incidentally and consequentially occurred.
- Panjit International Inc. does not assume any and all implied warranties, including warranties of fitness for particular purpose, non-infringement and merchantability.
- Applications shown on the herein document are examples of standard use and operation. Customers are responsible in comprehending the suitable use in particular applications. Panjit International Inc. makes no representation or warranty that such applications will be suitable for the specified use without further testing or modification.
- The products shown herein are not designed and authorized for equipments requiring high level of reliability or relating to human life and for any applications concerning life-saving or life-sustaining, such as medical instruments, transportation equipment, aerospace machinery et cetera. Customers using or selling these products for use in such applications do so at their own risk and agree to fully indemnify Panjit International Inc. for any damages resulting from such improper use or sale.
- Since Panjit uses lot number as the tracking base, please provide the lot number for tracking when complaining.