

### SPECIFICATIONS

Current Rating: 1A AC,DC  
 Voltage Rating: 50V AC,DC  
 Temperature Range: -25°C to +85°C  
 Contact Resistance: 20mΩ Max  
 Insulation Resistance: 100MΩ Min  
 Withstanding Voltage:500V AC/minute

### MATERIAL

Insulator:Hi-Temp. Thermoplastic,UL94V-0  
 Contact:Copper Alloy

### ORDER INFORMATION

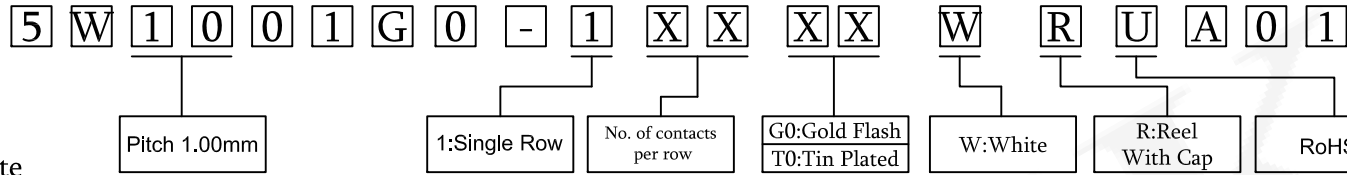

Circuit No.	Dimensions			Circuit No.	Dimensions		
	A	B	C		A	B	C
02P	1.00	4.00	2.45	12P	11.00	14.00	12.45
03P	2.00	5.00	3.45	13P	12.00	15.00	13.45
04P	3.00	6.00	4.45	14P	13.00	16.00	14.45
05P	4.00	7.00	5.45	15P	14.00	17.00	15.45
06P	5.00	8.00	6.45	16P	15.00	18.00	16.45
07P	6.00	9.00	7.45	17P	16.00	19.00	17.45
08P	7.00	10.00	8.45	18P	17.00	20.00	18.45
09P	8.00	11.00	9.45	19P	18.00	21.00	19.45
10P	9.00	12.00	10.45	20P	19.00	22.00	20.45
11P	10.00	13.00	11.45	24P	23.00	26.00	24.45

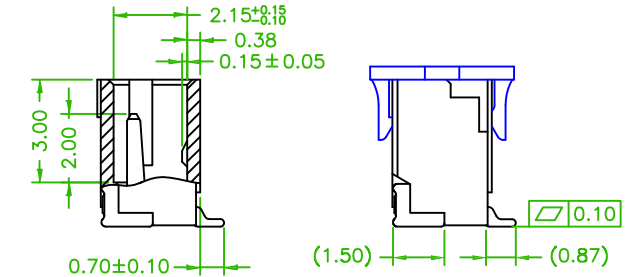
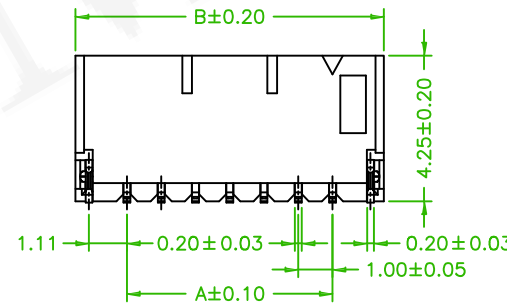
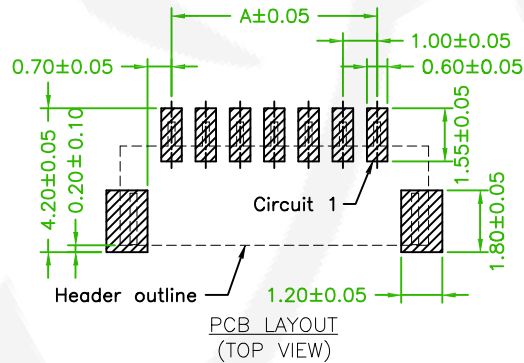
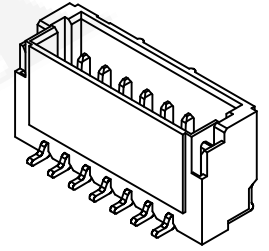
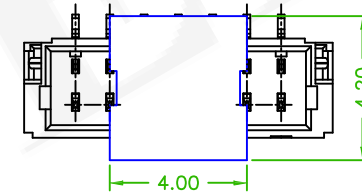
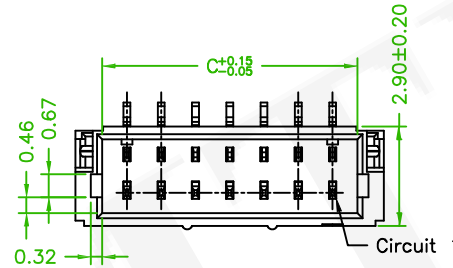

Old Part No.:1001MS-1XXXW-U

REV.	ECN NO. OR DESCRIPTION	REVISED	DATE

 糧德精密有限公司 Amtek Technology Co., Ltd. TEL: 886-2-2260-6878 FAX: 886-2-2260-8030	品名 TITLE	1.0mm WAFER SMT STRAIGHT			頁數 Page	1/1
	品號 PART NO.	5W1001G0-1XXXXWRUA01			繪圖 DRAWN	Roy 2016/08/17
	圖號 DRAWING NO.		版本 REV.	A	核對 CHECKED	Boris 2016/08/17
	客戶品號 CUSTOMER P/N		比例 SCALE	None	承認 APPROVED	Boris 2016/08/17
	公差 TOLERANCE	.X ± 0.25 .XX ± 0.15	.X° ± 1°	單位 UNIT	mm	THIRD ANGLE PROJECTION