

# General Purpose Ceramic Capacitors (C Series)

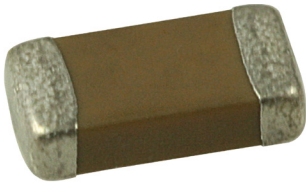

## Features:

- RoHS Compliant and Halogen Free
- Capacitance range: 0.1pF to 220uF
- Voltage range: 4V to 100V
- Terminations: 100% matte Tin (Sn), Palladium (Pd-Ag), Gold (Au) and Lead (Pb)
- Very low ESR in X7R/X5R (<10mΩ typical)

## Part Number Structure

C Series	0805 Size	COG Temperature Characteristic (Dielectric)	500 Rated Voltage	101 Capacitance (picofarads)	J Tolerance	N Termination	P Packaging	Optional Thickness Identifier
01005	0201	COG	1st two digits are significant followed by number of zeroes.	1st two digits are significant, followed by number of zeroes. <b>e.g:</b> 101 = 100pF	* B = ± 0.1pF * C = ± 0.25pF * D = ± 0.5pF F = ± 1% G = ± 2% J = ± 5% K = ± 10% M = ± 20% N = ± 30% Z = +80 - 20% * For values below 10pF only.	N = 100% matte Tin (Sn) over Nickel * P = Palladium Silver * G = Gold over Nickel Pb = 90% Tin (Sn)/10% Lead (Pb) * Pd/Ag & Gold terminations have limited values & sizes available.	D = Paper Tape (10" Reel) E = Embossed Tape (7" Reel) P = Paper Tape (7" Reel) R = Paper Tape (13" Reel) U = Embossed Tape (13" Reel)	Leave blank for standard thickness. Designate "-" for Min. "*" for Max. followed by Thickness Code <b>e.g:</b> -E (min. thickness of .026") *E (max. thickness of .026")
0402	0504	X7R	4R0 = 4.0 VDCW	R denotes decimal				
0603	0805	X6S	6R3 = 6.3 VDCW	6R8 = 6.8pF				
0805	1206	X5R	100 = 10 VDCW					
1206	1210	Y5V	160 = 16 VDCW					
1812	2220	Z5U	250 = 25 VDCW					
2220	2221		500 = 50 VDCW 630 = 63 VDCW 101 = 100 VDCW					

Example P/N: C0805C0G500-101JNP

### Optional Thickness Identifier Codes:

CODE:	C	D	E	F	G	H	I	J	K	L	M	N	O	P	Q	R	S	T	U	V	6
DIMENSION:	.015	.020	.026	.030	.035	.040	.045	.050	.055	.060	.065	.070	.075	.080	.085	.090	.095	.100	.105	.110	.023

## Dimensions

Unit: inches (mm)

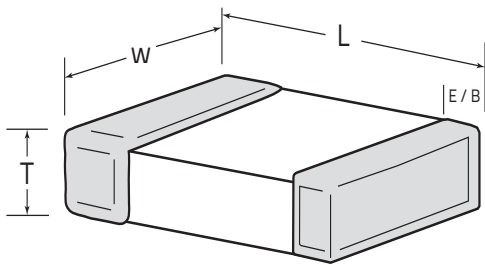

Size	L	W	T	E/B
01005	0.016 ± 0.0008 (0.4 ± 0.02)	0.008 ± 0.0008 (0.2 ± 0.02)	See Specific Value	0.002 (min.) (0.05)
0201	0.024 ± 0.002 (0.6 ± 0.05)	0.012 ± 0.002 (0.3 ± 0.05)	See Specific Value	0.002 (min.) (0.20)
0402	0.040 ± 0.002 (1.0 ± 0.05)	0.020 ± 0.002 (0.5 ± 0.05)	See Specific Value	0.004 (min.) (0.10)
0603	0.063 ± 0.006 (1.6 ± 0.15)	0.031 ± 0.0046 (0.8 ± 0.15)	See Specific Value	0.008 (min.) (0.20)
0805	0.08 ± 0.008 (2.0 ± 0.20)	0.050 ± 0.008 (1.25 ± 0.20)	See Specific Value	0.020 ± 0.010 (0.508 ± 0.254)
1206	0.126 ± 0.008 (3.2 ± 0.20)	0.063 ± 0.008 (1.6 ± 0.20)	See Specific Value	0.020 ± 0.010 (0.508 ± 0.254)
1210	0.126 ± 0.008 (3.2 ± 0.20)	0.098 ± 0.008 (2.50 ± 0.20)	See Specific Value	0.020 ± 0.010 (0.508 ± 0.254)
1812	0.177 ± 0.012 (4.495 ± 0.30)	0.126 ± 0.012 (3.20 ± 0.30)	See Specific Value	0.024 ± 0.015 (0.6096 ± 0.381)
2220	0.225 ± 0.016 (5.715 ± 0.41)	0.200 ± 0.006 (5.08 ± 0.41)	See Specific Value	0.025 ± 0.015 (0.635 ± 0.381)

## Structure

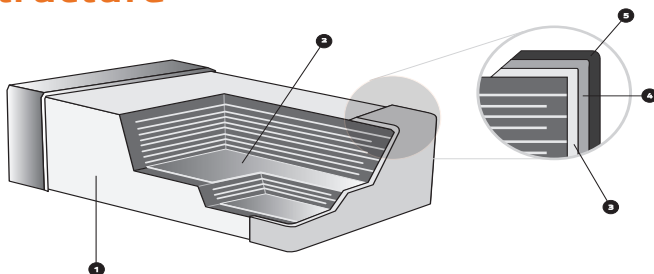

1	Ceramic Body (dielectric)	4	Nickel Plating
2	Inner Electrode	5	Tin Plating
3	Inner Termination		

# General Purpose Ceramic Capacitors (C Series)

## Electrical Specifications

### NPO/COG

Typical Capacitance Change vs. Temperature

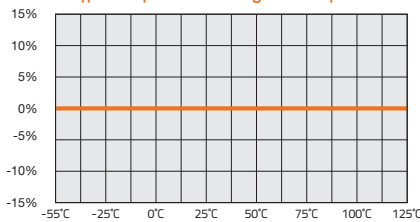

**Operating Temperature Range:**  
-55°C to +125°C

**Temperature Coefficient:**  
0 ±30PPM/°C

**Temperature Voltage Coefficient:**  
0 ±30PPM/°C

**Insulation Resistance:**  
>1000 Ω-F or 10 GΩ, for values ≤ 0.047μF (whichever is less at 25°C, VDCV).  
For Capacitance values > 0.047μF, the 500 Ω-F rule applies. (The IR at 125°C is 10% of the value at 25°C)

**Ageing:**  
None

**Withstanding Voltage:**  
>2.5 times VDCV

**Capacitance Tolerance:**  
B,C,D,F,G,J,K

**Dissipation Factor:**  
0.1% max

### X7R

Typical Capacitance Change vs. Temperature

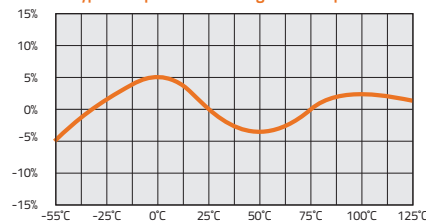

**Operating Temperature Range:**  
-55°C to +125°C

**Temperature Coefficient:**  
0 ±15%Δ°C MAX.

**Temperature Voltage Coefficient:**  
X7R not applicable

**Insulation Resistance:**  
>100 Ω-F or 10 GΩ, whichever is less at 25°C, VDCV. (The IR at 125°C is 10% of the value at 25°C)

**Ageing:**  
2.5% per decade hour, typical

**Withstanding Voltage:**  
>2.5 times VDCV

**Capacitance Tolerance:**  
J,K,M

Rated Voltage	D.F.	Exception of D.F.	
≥50V	≤2.5%	≤3%	0201 (50V); 0603≥0.047μF 0805≥0.22μF; 1206≥0.47μF
		≤5%	0603≥1μF; 0805≥1μF; 1206≥4.7μF; 1210≥4.7μF
25V	≤2.5%	≤5%	0201≥0.01μF; 0805≥1μF; 1210≥4.7μF
		≤10%	0402≥0.10μF; 0603≥0.33μF; 0805≥2.2μF 1206≥4.7μF; 1210≥22μF
16V	≤3.5%	≤5%	0201≥0.01μF; 0402≥0.033μF; 0805≥0.68μF; 1206≥2.2μF; 1210≥4.7μF
		≤10%	0402≥0.47μF; 0603≥0.68μF; 0805≥2.2μF; 1206≥4.7μF; 1210≥22μF
10V	≤5%	≤10%	0402≥0.33μF; 0603≥0.33μF; 0805≥2.2μF; 1206≥2.2μF; 1210≥22μF
6.3V	≤10%		

### X5R

Typical Capacitance Change vs. Temperature

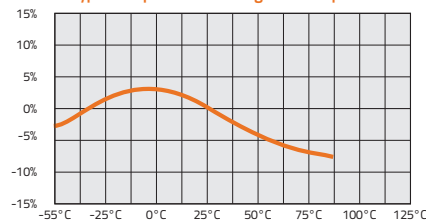

**Operating Temperature Range:**  
-55°C to +85°C

**Temperature Coefficient:**  
0 ±15%Δ°C MAX.

**Temperature Voltage Coefficient:**  
X5R not applicable

**Insulation Resistance:**  
>100 Ω-F or 10 GΩ, whichever is less at 25°C, VDCV. (The IR at 125°C is 10% of the value at 25°C)

**Ageing:**  
2.5% per decade hour, typical

**Withstanding Voltage:**  
>2.5 times VDCV

**Capacitance Tolerance:**  
K,M

Rated Voltage	D.F.	Exception of D.F.	
≥50V	≤2.5%	≤3%	0201 (50V); 0603≥0.047μF 0805≥0.22μF; 1206≥0.47μF
		≤5%	0603≥1μF; 0805≥1μF; 1206≥4.7μF; 1210≥4.7μF
25V	≤2.5%	≤5%	0201≥0.01μF; 0805≥1μF; 1210≥4.7μF
		≤10%	0402≥0.10μF; 0603≥0.33μF; 0805≥2.2μF 1206≥4.7μF; 1210≥22μF
16V	≤3.5%	≤5%	0201≥0.01μF; 0402≥0.033μF; 0805≥0.68μF; 1206≥2.2μF; 1210≥4.7μF
		≤10%	0402≥0.47μF; 0603≥0.68μF; 0805≥2.2μF; 1206≥4.7μF; 1210≥22μF
10V	≤5%	≤10%	0402≥0.33μF; 0603≥0.33μF; 0805≥2.2μF; 1206≥2.2μF; 1210≥22μF
6.3V	≤10%		

### Z5U

Typical Capacitance Change vs. Temperature

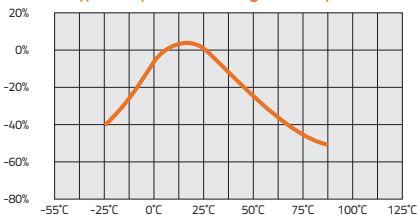

**Operating Temperature Range:**  
+10°C to +85°C

**Temperature Coefficient:**  
+22% - 56%Δ°C MAX.

**Insulation Resistance:**  
>100 Ω-F or 10 GΩ, whichever is less at 25°C, VDCV. (The IR at 125°C is 10% of the value at 25°C)

**Ageing:**  
5% per decade hour, typical

**Withstanding Voltage:**  
>2.5 times VDCV

**Capacitance Tolerance:**  
M,Z

Rated Voltage	D.F.	Exception of D.F.	
≥50V	≤5%	≤9%	0603≥0.1μF; 0805≥0.47μF; 1206≥4.7μF;
25V	≤5%	≤9%	0402≥0.047μF; 0603≥0.1μF; 0805≥0.33μF; 1206≥1μF; 1210≥4.7μF
		≤12.5%	0603≥2.2μF; 0805≥3.3μF; 1206≥10μF; 1210≥22μF; 1812≥47μF
10V	≤12.5%	≤16%	0603≥2.2μF; 0805≥3.3μF; 1206≥4.7μF; 1210≥10μF; 1812≥47μF
6.3V	≤16%		

# General Purpose Ceramic Capacitors (C Series)

## Electrical Specifications

### Y5V

Typical Capacitance Change vs. Temperature

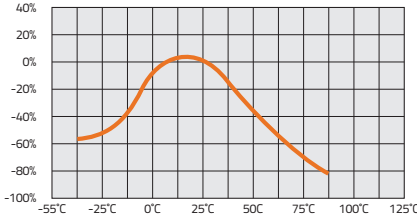

**Operating Temperature Range:**  
-30°C to +85°C  
**Temperature Coefficient:**  
+22% - 82%Δ°C MAX.  
**Insulation Resistance:**  
>100 Ω-F or 10 GΩ, whichever is less at 25°C, WDCV. (The IR at 125°C is 10% of the value at 25°C)  
**Ageing:**  
7% per decade hour, typical  
**Withstanding Voltage:**  
>2.5 times VDCW  
**Capacitance Tolerance:**  
M,Z

Rated Voltage	D.F.	Exception of D.F.	
≥50V	≤5%	≤9%	0603≥0.1uF; 0805≥0.47uF; 1206≥4.7uF;
25V	≤5%	≤9%	0402≥0.047uF; 0603≥0.1uF; 0805≥0.33uF; 1206≥1uF; 1210≥4.7uF
16V	≤9%	≤12.5%	0603≥2.2uF; 0805≥3.3uF; 1206≥10uF; 1210≥22uF; 1812≥47uF
10V	≤12.5%	≤16%	0603≥2.2uF; 0805≥3.3uF; 1206≥4.7uF; 1210≥10uF; 1812≥47uF
6.3V	≤16%		

## Test Parameters

Test parameters for Multilayer Ceramic Capacitors - X7R, X5R and Y5V:

1KHz ± 100Hz at 1.0 ± 0.2 Vrms < 10uF (10 V min.)  
1KHz ± 100Hz at 0.5 ± 0.1 Vrms < 10uF (6.3V max.)  
120Hz ± 24Hz at 1.0 ± 0.1 Vrms ≥ 10uF

Test parameters for Multilayer Ceramic Capacitors - NPO/COG:

1MHz ± 100KHz at 1.0 ± 0.2 Vrms ≤ 1000pF, 25°C  
1KHz ± 100Hz at 1.0 ± 0.2 Vrms > 1000pF, 25°C

**Note:** To ensure proper capacitance readings, the voltage level must be held constant. The HP4284 and Agilent E4980 has a "ALC" (Automatic Level Control) function and should be switched to the "ON" position for accurate capacitance readings.

## Voltage and Capacitance Range

### COG (NPO) Dielectric

Values that are typically available.

(All measurements in inches)

Size	01005 (± 0.0008)		0201 (± 0.002)		0402 (± 0.004)		0504 (± 0.008)		0603 (± 0.006)		0805 (± 0.008)			1206 (± 0.008)		1210 (± 0.008)		1812 (± 0.012)			
	T (max)	0.008	0.012	0.025	0.040	0.033	0.055	0.070	0.075	0.085											
Min E/B	0.002	0.002	0.004	0.005	0.008	0.020 ± .010	0.020 ± .010	0.020 ± .010	0.024 ± .015												
VDCW (MAX)	6.3V	16V	25V	50V	25V	50V	25V	50V	100V	50V	100V	50V	100V	25V	50V	100V	50V	100V	50V	100V	
OR1	0.1pF																				
OR2	0.2pF																				
OR3	0.3pF																				
OR4	0.4pF																				
OR5	0.5pF																				
1R0	1.0pF																				
1R2	1.2																				
1R5	1.5																				
1R8	1.8																				
2R2	2.2																				
2R7	2.7																				
3R3	3.3																				
3R9	3.9																				
4R7	4.7																				
5R0	5.0																				
5R6	5.6																				
6R8	6.8																				
8R2	8.2																				
100	10pF																				
120	12																				
150	15																				
180	18																				
220	22																				

**Note:** Additional values may be available. Please contact us for more information. Due to demand and raw material fluctuations, specific values may not be available.

# General Purpose Ceramic Capacitors (C Series)

## Voltage and Capacitance Range

### COG (NPO) Dielectric

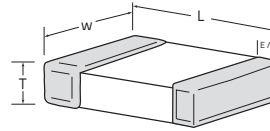

Values that are typically available.

(All measurements in inches)

Size	01005 (± 0.0008)		0201 (± 0.002)		0402 (± 0.004)		0504 (± 0.008)		0603 (± 0.006)		0805 (± 0.008)		1206 (± 0.008)		1210 (± 0.008)		1812 (± 0.012)		2220 / 2221 (± 0.016)				
L	0.016		0.024		0.040		0.053		0.063		0.080		0.126		0.126		0.177		0.225 / .225				
W	0.008		0.012		0.020		0.040		0.032		0.050		0.063		0.098		0.126		0.200 / .210				
T (max)	0.008		0.012		0.025		0.040		0.033		0.055		0.070		0.075		0.085		0.108 / .108				
Min E/B	0.002		0.002		0.004		0.005		0.008		0.020 ± .010		0.020 ± .010		0.020 ± .010		0.024 ± .015		0.025 ± .015				
VDCW (MAX)	6.3V	16V	25V	50V	25V	50V	25V	50V	100V	50V	100V	50V	100V	25V	50V	100V	50V	100V	50V	100V	50V	100V	
270	27																						
330	33																						
390	39																						
470	47																						
560	56																						
680	68																						
820	82																						
101	100pF																						
121	120																						
151	150																						
181	180																						
221	220																						
271	270																						
331	330																						
391	390																						
471	470																						
561	560																						
681	680																						
821	820																						
102	1000pF																						
122	1200																						
152	1500																						
182	1800																						
222	2200																						
272	2700																						
332	3300																						
392	3900																						
472	4700																						
562	5600																						
682	6800																						
822	8200																						
103	.01uF																						
123	.012																						
153	.015																						
183	.018																						
223	.022																						
273	.027																						
333	.033																						
393	.039																						
473	.047																						
563	.056																						
683	.068																						
823	.082																						
104	.10uF																						
124	.120																						
154	.150																						
184	.180																						
224	.220																						
274	.270																						
334	.330																						
394	.390																						
474	.470																						
564	.560																						
684	.680																						
824	.820																						

Note: Additional values may be available. Please contact us for more information. Due to demand and raw material fluctuations, specific values may not be available.

# General Purpose Ceramic Capacitors (C Series)

## Voltage and Capacitance Range

### X7R Dielectric

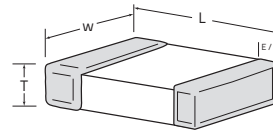

Values that are typically available.

(All measurements in inches)

Size	01005 (± 0.0008)		0201 (± 0.002)				0402 (± 0.004)				0504 (± 0.008)			0603 (± 0.006)				0805 (± 0.008)				
L	0.016		0.024				0.040				0.053			0.063				0.080				
W	0.008		0.012				0.020				0.040			0.032				0.050				
T (max)	0.008		0.012				0.025				0.040			0.038				0.058				
Min E/B	0.002		0.002				0.004				0.005			0.008				0.020 ± .010				
VDCW (MAX)	6.3V	10V	6.3V	10V	16V	25V	16V	25V	50V	100V	25V	50V	100V	10V	16V	25V	50V	100V	25V	50V	100V	
101	100pF																					
121	120																					
151	150																					
181	180																					
221	220																					
271	270																					
331	330																					
391	390																					
471	470																					
561	560																					
681	680																					
821	820																					
102	1000pF																					
122	1200																					
152	1500																					
182	1800																					
222	2200																					
272	2700																					
332	3300																					
392	3900																					
472	4700																					
562	5600																					
682	6800																					
822	8200																					
103	.01uF																					
123	.012																					
153	.015																					
183	.018																					
223	.022																					
273	.027																					
333	.033																					

**Note:** Additional values may be available. Please contact us for more information. Due to demand and raw material fluctuations, specific values may not be available.  
All components manufactured with the X7R dielectric are also available as an X5R dielectric.

# General Purpose Ceramic Capacitors (C Series)

## Voltage and Capacitance Range

### X7R Dielectric

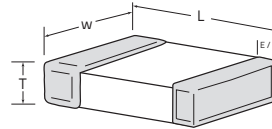

Values that are typically available.

(All measurements in inches)

Size	0201 (± 0.002)			0402 (± 0.004)					0603 (± 0.006)					0805 (± 0.008)						
L	0.024			0.040					0.063					0.080						
W	0.012			0.020					0.032					0.050						
T (max)*	0.012			0.025					0.038					0.058						
Min E/B	0.002			0.004					0.008					0.020 ± .010						
VDCW (MAX)	4V	6.3V	10V	6.3V	10V	16V	25V	50V	6.3V	10V	16V	25V	50V	100V	6.3V	10V	16V	25V	50V	100V
393	.039																			
473	.047																			
563	.056																			
683	.068																			
823	.082																			
104	.100uF																			
124	.120																			
154	.150																			
184	.180																			
224	.220																			
274	.270																			
334	.330																			
394	.390																			
474	.470																			
564	.560																			
684	.680																			
824	.820																			
105	1.00uF																			
125	1.20																			
155	1.50																			
185	1.80																			
225	2.20																			
335	3.30																			
475	4.70																			
685	6.80																			
106	10.0uF																			
156	15.0uF																			
226	22.0uF																			
476	47.0uF																			
107	100.0uF																			

\* For values above 1uF, thickness may be greater than specified above.  
T(max): 0603 – 0.040"  
0805 – 0.060"

**Note:** Additional values may be available. Please contact us for more information. Due to demand and raw material fluctuations, specific values may not be available.  
All components manufactured with the X7R dielectric are also available as an X5R dielectric.

# General Purpose Ceramic Capacitors (C Series)

## Voltage and Capacitance Range

### X7R Dielectric

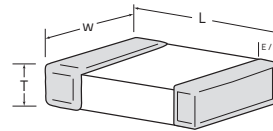

Values that are typically available.

(All measurements in inches)

Size	1206 (± 0.008)					1210 (± 0.008)					1812 (± 0.012)					2220 / 2221 °(± 0.016)				
L	0.126					0.126					0.177					0.225 / .225				
W	0.063					0.098					0.126					0.200 / .210				
T (max)*	0.070					0.125					0.085					0.108 / .108				
Min E/B	0.020 ± .010					0.020 ± .010					.024 ± .015					00.025 ± .015				
VDCW (MAX)	10V	16V	25V	50V	100V	10V	16V	25V	50V	100V	6.3V	10V	16V	25V	50V	100V	16V	25V	50V	100V
102	1000pF																			
122	1200																			
152	1500																			
182	1800																			
222	2200																			
272	2700																			
332	3300																			
392	3900																			
472	4700																			
562	5600																			
682	6800																			
822	8200																			
103	.01uF																			
123	.012																			
153	.015																			
183	.018																			
223	.022																			
273	.027																			
333	.033																			
393	.039																			
473	.047																			
563	.056																			
683	.068																			
823	.082																			
104	.100uF																			
124	.120																			
154	.150																			
184	.180																			
224	.220																			
274	.270																			
334	.330																			

\* For values above 1uF, thickness may be greater than specified above.

T(max): 1206 – 0.075"    1812 – 0.130"  
 1210 – 0.125"    2220 – 0.135"

**Note:** Additional values may be available. Please contact us for more information. Due to demand and raw material fluctuations, specific values may not be available.  
 All components manufactured with the X7R dielectric are also available as an X5R dielectric.

# General Purpose Ceramic Capacitors (C Series)

## Voltage and Capacitance Range

### X7R Dielectric

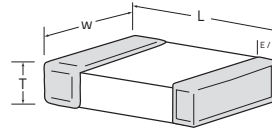

Values that are typically available.

(All measurements in inches)

Size	1206 (± 0.008)						1210 (±0.008)						1812 (±0.012)						2220 / 2221 (±0.016)			
L	0.126						0.126						0.177						0.225 / .225			
W	0.063						0.098						0.126						0.200 / .210			
T (max)*	0.070						0.125						0.095						0.108 / .108			
Min E/B	0.020 ± .010						0.020 ± .010						0.024 ± .015						0.025 ± .015			
VDCW (MAX)	6.3V	10V	16V	25V	50V	100V	6.3V	10V	16V	25V	50V	100V	6.3V	10V	16V	25V	50V	100V	16V	25V	50V	100V
394	.390																					
474	.470																					
564	.560																					
684	.680																					
824	.820																					
105	1.00uF																					
125	1.20																					
155	1.50																					
185	1.80																					
225	2.20																					
335	3.30																					
475	4.70																					
685	6.80																					
106	10.0uF																					
156	15.0uF																		X7S	X7S	X7S	
226	22.0uF																					
476	47.0uF																					
107	100.0uF																					

\* For values above 1uF, thickness may be greater than specified above.

T(max): 1206 – 0.075"    1812 – 0.130"  
 1210 – 0.125"    2220 – 0.135"

**Note:** Additional values may be available. Please contact us for more information. Due to demand and raw material fluctuations, specific values may not be available.  
 All components manufactured with the X7R dielectric are also available as an X5R dielectric.



# General Purpose Ceramic Capacitors (C Series)

## Voltage and Capacitance Range

### X5R Dielectric

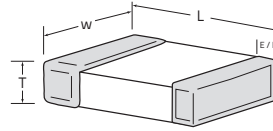

Values that are typically available.

(All measurements in inches)

Size	01005 (± 0.0008)		0201 (± 0.002)				0402 (± 0.004)				0603 (± 0.006)				0805 (± 0.008)				1206 (± 0.008)				1210 (±0.016)		1812 (±0.016)							
L	0.016		0.024				0.040				0.063				0.080				0.126				0.126		0.177							
W	0.008		0.012				0.020				0.032				0.050				0.063				0.098		0.126							
T (max)	0.008		0.0216				0.025				0.040				0.060				0.072				0.125		0.130							
Min. E/B	0.002		0.002				0.004				0.008				0.020 ± .010				0.020 ± .010				0.020 ± .010		0.024 ± .015							
VDCW (MAX)	6.3V 10V		4V	6.3V	10V	16V	25V	4V	6.3V	10V	16V	25V	50V	6.3V	10V	16V	25V	35V	50V	6.3V	10V	16V	25V	50V	6.3V	10V	16V	25V	16V	25V	16V	25V
102	1000pF																															
122	1200																															
152	1500																															
182	1800																															
222	2200																															
272	2700																															
332	3300																															
392	3900																															
472	4700																															
562	5600																															
682	6800																															
822	8200																															
103	.01uF																															
153	.015																															
223	.022																															
333	.033																															
393	.039																															
473	.047																															
104	0.10uF																															
154	.150																															
224	.220																															
334	.330																															
474	.470																															
684	.680																															
105	1.00uF																															
125	1.20																															
155	1.50																															
185	1.80																															
225	2.20																															
335	3.30																															

For values above 1uF, thickness may be greater than specified above.

T(max): 1206 - 0.075"    1812 - 0.130"  
 1210 - 0.125"    2220 - 0.135"

**Note:** Additional values may be available. Please contact us for more information. Due to demand and raw material fluctuations, specific values may not be available.  
 All components manufactured with the X7R dielectric are also available as an X5R dielectric.

# General Purpose Ceramic Capacitors (C Series)

## Voltage and Capacitance Range

### X5R Dielectric (0402 - 1206)

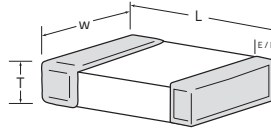

Values that are typically available.

(All measurements in inches)

Size	0201 (± 0.002)			0402 (± 0.009)			0603 (± 0.006)					0805 (± 0.008)					1206 (± 0.008)						
L	0.024			0.040			0.063					0.080					0.126						
W	0.012			0.020			0.032					0.050					0.063						
T (max)	0.0216			0.0335			0.040					0.060					0.072						
Min E/B	0.002			0.004			0.008					0.020 ± .010					0.020 ± .010						
VDCW (MAX)	4V	6.3V	10V	4V	6.3V	10V	16V	4V	6.3V	10V	16V	25V	4V	6.3V	10V	16V	25V	50V	6.3V	10V	16V	25V	50V
395	3.90uF																						
475	4.70uF																						
685	6.80uF																						
106	10.0uF																						
156	15.0uF																						
226	22.0uF																						
476	47.0uF																						
107	100.0uF																						
157	150.0uF																						
227	220.0uF																						

### X5R Dielectric (1210 - 2221)

(All measurements in inches)

Size	1210 (±0.016)					1812 (±0.016)					2220 / 2221 (±0.016)				
L	0.126					0.177					0.225 / .225				
W	0.098					0.126					0.200 / .210				
T (max)	0.125					0.130					0.135				
Min E/B	0.020 ± .010					0.024 ± .015					0.025 ± .015				
VDCW (MAX)	6.3V	10V	16V	25V	50V	6.3V	10V	16V	25V	6.3V	10V	25V	50V		
395	3.90uF														
475	4.70uF														
685	6.80uF														
106	10.0uF														
156	15.0uF														
226	22.0uF														
476	47.0uF														
107	100.0uF														
157	150.0uF														
227	220.0uF														

For values above 1uF, thickness may be greater than specified above.

T(max): 1206 - 0.075"    1812 - 0.130"  
 1210 - 0.125"    2220 - 0.135"

**Note:** Additional values may be available. Please contact us for more information. Due to demand and raw material fluctuations, specific values may not be available. All components manufactured with the X7R dielectric are also available as an X5R dielectric.

# General Purpose Ceramic Capacitors (C Series)

## Voltage and Capacitance Range

### Z5U Dielectric

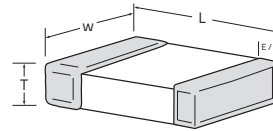

Values that are typically available.

(All measurements in inches)

Size	0504 (± 0.008)		0603 (± 0.006)		0805 (± 0.008)		1206 (± 0.008)		1210 (± 0.016)		1812 (± 0.016)		2220 / 2221 (± 0.016)	
L	0.050		0.063		0.080		0.126		0.126		0.177		0.225 / .225	
W	0.040		0.032		0.050		0.063		0.098		0.126		0.200 / .210	
T (max)	0.040		0.038		0.058		0.070		0.075		0.085		0.108 / .108	
Min E/B	0.005		0.008		0.020 ± .010		0.020 ± .010		0.020 ± .010		0.024 ± .015		0.025 ± .015	
VDCW (MAX)	25V	50V	25V	50V	25V	50V	25V	50V	25V	50V	25V	50V	25V	50V
102	1000pF													
122	1200													
152	1500													
182	1800													
222	2200													
272	2700													
332	3300													
392	3900													
472	4700													
562	5600													
682	6800													
822	8200													
103	.01uF													
123	.012													
153	.015													
183	.018													
223	.022													
273	.027													
333	.033													
393	.039													
473	.047													
563	.056													
683	.068													
823	.082													
104	.100uF													
124	.120													
154	.150													
184	.180													
224	.220													
274	.270													
334	.330													

Note: Additional values may be available. Please contact us for more information. Due to demand and raw material fluctuations, specific values may not be available.

# General Purpose Ceramic Capacitors (C Series)

## Voltage and Capacitance Range

### Z5U Dielectric

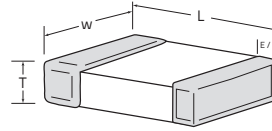

Values that are typically available.

(All measurements in inches)

Size	0504 (± 0.008)		0603 (± 0.006)		0805 (± 0.008)		1206 (± 0.008)		1210 (±0.016)		1812 (±0.016)		2220 / 2221 (±0.016)			
L	0.050		0.063		0.080		0.126		0.126		0.177		0.225 / .225			
W	0.040		0.032		0.050		0.063		0.098		0.126		0.200 / .210			
T (max)	0.040		0.038		0.058		0.070		0.075		0.085		0.108 / .108			
Min E/B	0.005		0.008		0.020 ± .010		0.020 ± .010		0.020 ± .010		0.024 ± .015		0.025 ± .015			
VDCW (MAX)	25V		50V		25V		50V		25V		50V		25V		50V	
394	.390															
474	.470															
564	.560															
684	.680															
824	.820															
105	1.00uF															
125	1.20															
155	1.50															
185	1.80															
225	2.20															
335	3.30															
395	3.90															
475	4.70															
685	6.80															
106	10.0uF															
156	15.0uF															
226	22.0uF															
476	47.0uF															
107	100.0uF															

**Note:** Additional values may be available. Please contact us for more information. Due to demand and raw material fluctuations, specific values may not be available. For values above 1uF, thickness may be greater than specified above.

# General Purpose Ceramic Capacitors (C Series)

## Voltage and Capacitance Range

### Y5V Dielectric

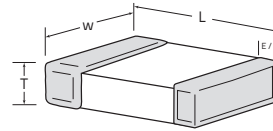

Values that are typically available.

(All measurements in inches)

Size	0201 (± 0.002)		0402 (± 0.004)			0603 (± 0.006)			0805 (± 0.008)				1206 (± 0.008)				1210 (±0.016)			1812 (±0.016)								
L	0.024		0.040			0.063			0.080				0.126				0.126			0.177								
W	0.012		0.020			0.032			0.050				0.063				0.098			0.126								
T (max)	0.012		0.025			0.038			0.058				0.070				0.096			0.085								
Min E/B	0.002		0.004			0.008			0.020 ± .010				0.020 ± .010				0.020 ± .010			0.024 ± .015								
VDCW (MAX)	10V	6.3V	10V	16V	25V	50V	6.3V	10V	16V	25V	50V	6.3V	10V	16V	25V	50V	10V	16V	25V	50V	6.3V	10V	16V	25V	6.3V	10V	25V	
102	1000pF																											
122	1200																											
152	1500																											
182	1800																											
222	2200																											
272	2700																											
332	3300																											
392	3900																											
472	4700																											
562	5600																											
682	6800																											
822	8200																											
103	.01uF																											
123	.012																											
153	.015																											
183	.018																											
223	.022																											
273	.027																											
333	.033																											
393	.039																											
473	.047																											
563	.056																											
683	.068																											
823	.082																											
104	.100uF																											
124	.120																											
154	.150																											
184	.180																											
224	.220																											
274	.270																											
334	.330																											

**Note:** Additional values may be available. Please contact us for more information. Due to demand and raw material fluctuations, specific values may not be available.  
For values above 1uF, thickness may be greater than specified above.

# General Purpose Ceramic Capacitors (C Series)

## Voltage and Capacitance Range

### Y5V Dielectric

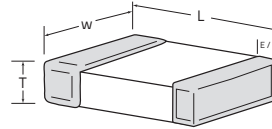

Values that are typically available.

(All measurements in inches)

Size	0201 (± 0.002)		0402 (± 0.004)		0603 (± 0.006)				0805 (± 0.008)			1206 (± 0.008)				1210 (± 0.016)				1812 (± 0.016)								
L	0.024		0.040		0.063				0.080			0.126				0.126				0.177								
W	0.012		0.020		0.032				0.050			0.063				0.098				0.126								
T (max)	0.012		0.025		0.038				0.058			0.070				0.10				0.085								
Min E/B	0.002		0.004		0.008				0.020 ± .010			0.020 ± .010				0.020 ± .010				0.024 ± .015								
VDCW (MAX)	10V		6.3V	10V	16V	6.3V	10V	16V	25V	50V	6.3V	10V	16V	25V	50V	10V	16V	25V	50V	6.3V	10V	16V	25V	50V	6.3V	10V	25V	
394	.390																											
474	.470																											
564	.560																											
684	.680																											
824	.820																											
105	1.00uF																											
125	1.20																											
155	1.50																											
185	1.80																											
225	2.20																											
335	3.30																											
395	3.90																											
475	4.70																											
685	6.80																											
106	10.0uF																											
156	15.0uF																											
226	22.0uF																											
476	47.0uF																											
107	100.0uF																											

**Note:** Additional values may be available. Please contact us for more information. Due to demand and raw material fluctuations, specific values may not be available. For values above 1uF, thickness may be greater than specified above.

# General Purpose Ceramic Capacitors (C Series)

## Tape and Reel Specifications

All tape and reel specifications must be adhered to per EIA-481-1-A.

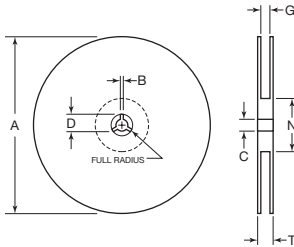

### Reel Dimensions

Unit: mm (inch)

Tape	B min	C	A (7")	A (13")	D min	N min	G	T max
4mm	2.0 (0.079)	13 ± 0.05 (0.512 ± 0.02)	178 ± 2.0 (7 ± 0.079)	-	21 ± 0.8 (0.82 ± 0.03)	50 (1.97)	5.0 ± 1.5 (0.196 ± 0.05)	8.0 max (0.315 max)
8mm	2.0 (0.07)	13 ± 0.05 (0.512 ± 0.02)	178 ± 2.0 (7 ± 0.079)	330 ± 2.0 (13 ± 0.08)	20.2 (0.795)	50 (1.97)	10 ± 1.5 (0.394 ± 0.059)	14.9 (0.587)
12mm	2.0 (0.07)	13 ± 0.05 (0.512 ± 0.02)	178 ± 2.0 (7 ± 0.079)	330 ± 2.0 (13 ± 0.08)	20.2 (0.795)	50 (1.97)	10 ± 1.5 (0.394 ± 0.059)	14.9 (0.587)

### Taping Specifications

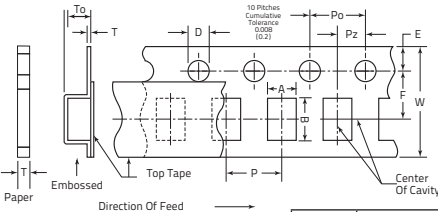

### 7 in. Reel Quantities \*\*

Size	01005 (E)	01005 (P)	0201	0402	0603	0805	1206	1210	1812	2221
Tape Size	4mm	8mm	8mm	8mm	8mm	8mm	8mm	8mm	12mm	12mm
Min Qty Per Reel	40,000*	20,000*	15,000	5,000	3,000	2,000	2,000	1,000	1,000	1,000
Max Qty Per Reel	40,000*	20,000*	15,000	10,000	4,000	5,000	5,000	5,000	3,000	1,000

Note: \*\* Quantity dependent on thickness

\*Smaller quantities may be available. Please contact us.

### Paper Tape Carrier Dimensions (8mm)

Unit: mm (inch)

Size (inches)	A	B	W	F	E	Po	Pz	D	t	P
01005	$\frac{0.25 \pm 0.05}{(0.010 \pm .002)}$	$\frac{0.45 \pm 0.05}{(0.018 \pm .002)}$	$\frac{8.0 \pm 0.2}{(.315 \pm .008)}$	$\frac{3.5 \pm 0.1}{(.138 \pm .004)}$	$\frac{1.75 \pm 0.1}{(.069 \pm .004)}$	$\frac{4.0 \pm 0.1}{(.157 \pm .004)}$	$\frac{2.0 \pm 0.05}{- 0.0}$ $\frac{(0.039 \pm .002)}{-.000}$	$\frac{1.5 \pm 0.1}{(.064 \pm .004)}$	$\frac{1.15 \text{ MAX}}{(0.045 \text{ MAX})}$	$\frac{2.0 \pm 0.05}{(.079 \pm .002)}$
0201	$\frac{0.37 \pm 0.05}{(0.014 \pm .002)}$	$\frac{0.67 \pm 0.05}{(0.026 \pm .002)}$	$\frac{8.0 \pm 0.2}{(.315 \pm .008)}$	$\frac{3.5 \pm 0.1}{(.138 \pm .004)}$	$\frac{1.75 \pm 0.1}{(.069 \pm .004)}$	$\frac{4.0 \pm 0.1}{(.157 \pm .004)}$	$\frac{2.0 \pm 0.05}{- 0.0}$ $\frac{(0.039 \pm .002)}{-.000}$	$\frac{1.5 \pm 0.1}{(.064 \pm .004)}$	$\frac{1.15 \text{ MAX}}{(0.045 \text{ MAX})}$	$\frac{2.0 \pm 0.05}{(.079 \pm .002)}$
0402	$\frac{0.65 \pm 0.1}{(.026 \pm .004)}$	$\frac{1.10 \pm 0.2}{(.043 \pm .008)}$	$\frac{8.0 \pm 0.2}{(.315 \pm .008)}$	$\frac{3.5 \pm 0.1}{(.138 \pm .004)}$	$\frac{1.75 \pm 0.1}{(.069 \pm .004)}$	$\frac{4.0 \pm 0.1}{(.157 \pm .004)}$	$\frac{2.0 \pm 0.05}{- 0.0}$ $\frac{(0.039 \pm .002)}{-.000}$	$\frac{1.5 \pm 0.1}{(.064 \pm .004)}$	$\frac{1.15 \text{ MAX}}{(0.045 \text{ MAX})}$	$\frac{2.0 \pm 0.05}{(.079 \pm .002)}$
0603	$\frac{1.10 \pm 0.2}{(.043 \pm .008)}$	$\frac{1.90 \pm 0.2}{(.075 \pm .008)}$	$\frac{8.0 \pm 0.2}{(.315 \pm .008)}$	$\frac{3.5 \pm 0.1}{(.138 \pm .004)}$	$\frac{1.75 \pm 0.1}{(.069 \pm .004)}$	$\frac{4.0 \pm 0.1}{(.157 \pm .004)}$	$\frac{2.0 \pm 0.05}{- 0.0}$ $\frac{(0.039 \pm .002)}{-.000}$	$\frac{1.5 \pm 0.1}{(.064 \pm .004)}$	$\frac{1.15 \text{ MAX}}{(0.045 \text{ MAX})}$	$\frac{4.0 \pm 0.1}{(.157 \pm .004)}$
0805	$\frac{1.16 \pm 0.2}{(.046 \pm .008)}$	$\frac{2.4 \pm 0.2}{(.095 \pm .008)}$	$\frac{8.0 \pm 0.2}{(.315 \pm .008)}$	$\frac{3.5 \pm 0.1}{(.138 \pm .004)}$	$\frac{1.75 \pm 0.1}{(.069 \pm .004)}$	$\frac{4.0 \pm 0.1}{(.157 \pm .004)}$	$\frac{2.0 \pm 0.05}{- 0.0}$ $\frac{(0.039 \pm .002)}{-.000}$	$\frac{1.5 \pm 0.1}{(.064 \pm .004)}$	$\frac{1.15 \text{ MAX}}{(0.045 \text{ MAX})}$	$\frac{4.0 \pm 0.1}{(.157 \pm .004)}$
1206	$\frac{2.0 \pm 0.2}{(.079 \pm .008)}$	$\frac{3.6 \pm 0.2}{(.142 \pm .008)}$	$\frac{8.0 \pm 0.2}{(.315 \pm .008)}$	$\frac{3.5 \pm 0.1}{(.138 \pm .004)}$	$\frac{1.75 \pm 0.1}{(.069 \pm .004)}$	$\frac{4.0 \pm 0.1}{(.157 \pm .004)}$	$\frac{2.0 \pm 0.05}{- 0.0}$ $\frac{(0.039 \pm .002)}{-.000}$	$\frac{1.5 \pm 0.1}{(.064 \pm .004)}$	$\frac{1.15 \text{ MAX}}{(0.045 \text{ MAX})}$	$\frac{4.0 \pm 0.1}{(.157 \pm .004)}$

### Embossed Carrier Dimensions (4mm, 8mm & 12mm)

Size (inches)	A	B	W	F	E	Po	Pz	D	To	T	P
01005	$\frac{0.23}{(0.009)}$	$\frac{0.43}{(0.016)}$	$\frac{4.0 \pm 0.05}{(0.157 \pm 0.002)}$	$\frac{1.8 \pm 0.02}{(0.070 \pm 0.001)}$	$\frac{0.9 \pm 0.05}{(0.035 \pm 0.002)}$	$\frac{2.0 \pm 0.04}{(0.079 \pm 0.001)}$	$\frac{2.00}{(0.079)}$	$\frac{0.8 \pm 0.04}{(0.031 \pm 0.001)}$	$\frac{0.5 \text{ max}}{(0.019 \text{ max})}$	$\frac{0.15 - 0.4}{(0.005 - 0.015)}$	$\frac{1.00}{(0.039)}$
0805	$\frac{1.48 \pm 0.2}{(.058 \pm .008)}$	$\frac{2.3 \pm 0.2}{(.091 \pm .008)}$	$\frac{8.0 \pm 0.2}{(.315 \pm .008)}$	$\frac{3.5 \pm 0.1}{(.138 \pm .004)}$	$\frac{1.75 \pm 0.1}{(.069 \pm .004)}$	$\frac{4.0 \pm 0.1}{(.157 \pm .004)}$	$\frac{2.0 \pm 0.05}{(.079 \pm .002)}$	$\frac{1.5 \pm 0.1}{- 0.0}$ $\frac{(.06 \pm .004)}{-.000}$	$\frac{2.5 \text{ MAX}}{(.098 \text{ MAX})}$	$\frac{0.6 \text{ MAX}}{(.024 \text{ MAX})}$	$\frac{4.0 \pm 0.1}{(.157 \pm .004)}$
1206	$\frac{2.0 \pm 0.2}{(.079 \pm .008)}$	$\frac{3.6 \pm 0.2}{(.142 \pm .008)}$	$\frac{8.0 \pm 0.2}{(.315 \pm .008)}$	$\frac{3.5 \pm 0.1}{(.138 \pm .004)}$	$\frac{1.75 \pm 0.1}{(.069 \pm .004)}$	$\frac{4.0 \pm 0.1}{(.157 \pm .004)}$	$\frac{2.0 \pm 0.05}{(.079 \pm .002)}$	$\frac{1.5 \pm 0.1}{- 0.0}$ $\frac{(.06 \pm .004)}{-.000}$	$\frac{2.5 \text{ MAX}}{(.098 \text{ MAX})}$	$\frac{0.6 \text{ MAX}}{(.024 \text{ MAX})}$	$\frac{4.0 \pm 0.1}{(.157 \pm .004)}$
1210	$\frac{2.9 \pm 0.2}{(.114 \pm .008)}$	$\frac{3.6 \pm 0.2}{(.142 \pm .008)}$	$\frac{8.0 \pm 0.2}{(.315 \pm .008)}$	$\frac{3.5 \pm 0.1}{(.138 \pm .004)}$	$\frac{1.75 \pm 0.1}{(.069 \pm .004)}$	$\frac{4.0 \pm 0.1}{(.157 \pm .004)}$	$\frac{2.0 \pm 0.05}{(.079 \pm .002)}$	$\frac{1.5 \pm 0.1}{- 0.0}$ $\frac{(.06 \pm .004)}{-.000}$	$\frac{2.5 \text{ MAX}}{(.098 \text{ MAX})}$	$\frac{0.6 \text{ MAX}}{(.024 \text{ MAX})}$	$\frac{4.0 \pm 0.1}{(.157 \pm .004)}$
1812	$\frac{3.6 \pm 0.2}{(.142 \pm .008)}$	$\frac{4.9 \pm 0.2}{(.193 \pm .008)}$	$\frac{12.0 \pm 0.3}{(.472 \pm .012)}$	$\frac{5.6 \pm 0.1}{(.221 \pm .004)}$	$\frac{1.75 \pm 0.1}{(.069 \pm .004)}$	$\frac{4.0 \pm 0.1}{(.157 \pm .004)}$	$\frac{2.0 \pm 0.05}{(.079 \pm .002)}$	$\frac{1.5 \pm 0.1}{- 0.0}$ $\frac{(.06 \pm .004)}{-.000}$	$\frac{3.8 \text{ MAX}}{(.150 \text{ MAX})}$	$\frac{0.6 \text{ MAX}}{(.024 \text{ MAX})}$	$\frac{8.0 \pm 0.1}{(.315 \pm .004)}$

# General Purpose Ceramic Capacitors (C Series)

## Environmental Test Criteria

NO	ITEM		PERFORMANCE	TEST CONDITION		
1	APPEARANCE		NO ABNORMAL EXTERIOR APPEARANCE	THROUGH MICROSCOPE (X10)		
2	INSULATION RESISTANCE		10,000M OR 500M $\mu$ F PRODUCT WHICHEVER IS SMALLER (RATED VOLTAGE IS BELOW 16V: 10,000M OR 100M $\mu$ F)	RATED VOLTAGE SHALL BE APPLIED. MEASUREMENT TIME IS 60 - 120 RATED VOLTAGE TIME 60 SEC .		
3	WITHSTANDING VOLTAGE		NO DIELECTRIC BREAKDOWN OR MECHANICAL BREAKDOWN	CLASS I : 300% OF THE RATED VOLTAGE FOR 1-5 SEC, CLASS II: 250% OF THE RATED VOLTAGE FOR 1-5 SEC IS APPLIED WITH LESS THAN 50 mA CURRENT		
4	CAPACITANCE	CLASS I	WITHIN THE SPECIFIED TOLERANCE	CAPACITANCE	FREQUENCY	VOLTAGE
				1,000pF AND BELOW	1MHz $\pm$ 10%	0.5 - 5 Vrms
		MORE THAN 1,000 pF		1kHz $\pm$ 10%		
		CLASS II		CAPACITANCE	FREQUENCY	VOLTAGE
10 $\mu$ F AND BELOW	1kHz $\pm$ 10%		1.0 $\pm$ 0.2Vrms			
MORE THAN 10 $\mu$ F	120Hz $\pm$ 20%		0.5 $\pm$ 0.1Vrms			
5	Q	CLASS I	OVER 30pF : Q 1,000 LESS THAN 30pF: Q 400 +20C (C: CAPACITANCE)	CAPACITANCE	FREQUENCY	VOLTAGE
				1,000pF AND BELOW	1MHz $\pm$ 10%	0.5 - 5 Vrms
				MORE THAN 1,000 pF	1kHz $\pm$ 10%	
6	DISSIPATION FACTOR (Tan $\theta$ CLASS II)	CLASS II	<b>X7R, X6S, X5R</b>			
			<b>Rated Voltage</b>	<b>D.F.</b>	<b>Exception of D.F.</b>	
			$\geq$ 50V	$\leq$ 2.5%	$\leq$ 3%	0201 (50V); 0603 $\geq$ 0.047 $\mu$ F 0805 $\geq$ 0.22 $\mu$ F; 1206 $\geq$ 0.47 $\mu$ F
					$\leq$ 5%	0603 $\geq$ 1 $\mu$ F; 0805 $\geq$ 1 $\mu$ F; 1206 $\geq$ 4.7 $\mu$ F; 1210 $\geq$ 4.7 $\mu$ F
			25V	$\leq$ 2.5%	$\leq$ 5%	0201 $\geq$ 0.01 $\mu$ F; 0805 $\geq$ 1 $\mu$ F; 1210 $\geq$ 4.7 $\mu$ F
					$\leq$ 10%	0402 $\geq$ 0.10 $\mu$ F; 0603 $\geq$ 0.33 $\mu$ F; 0805 $\geq$ 2.2 $\mu$ F 1206 $\geq$ 4.7 $\mu$ F; 1210 $\geq$ 22 $\mu$ F
			16V	$\leq$ 3.5%	$\leq$ 5%	0201 $\geq$ 0.01 $\mu$ F; 0402 $\geq$ 0.033 $\mu$ F; 0805 $\geq$ 0.68 $\mu$ F; 1206 $\geq$ 2.2 $\mu$ F; 1210 $\geq$ 4.7 $\mu$ F
					$\leq$ 10%	0402 $\geq$ 0.47 $\mu$ F; 0603 $\geq$ 0.68 $\mu$ F; 0805 $\geq$ 2.2 $\mu$ F; 1206 $\geq$ 4.7 $\mu$ F; 1210 $\geq$ 22 $\mu$ F
			10V	$\leq$ 5%	$\leq$ 10%	0402 $\geq$ 0.33 $\mu$ F; 0603 $\geq$ 0.33 $\mu$ F; 0805 $\geq$ 2.2 $\mu$ F; 1206 $\geq$ 2.2 $\mu$ F; 1210 $\geq$ 22 $\mu$ F
			6.3V	$\leq$ 10%		
			<b>Y5V, Z5U</b>			
			<b>Rated Voltage</b>	<b>D.F.</b>	<b>Exception of D.F.</b>	
			$\geq$ 50V	$\leq$ 5%	$\leq$ 9%	0603 $\geq$ 0.1 $\mu$ F; 0805 $\geq$ 0.47 $\mu$ F; 1206 $\geq$ 4.7 $\mu$ F;
			25V	$\leq$ 5%	$\leq$ 9%	0402 $\geq$ 0.047 $\mu$ F; 0603 $\geq$ 0.1 $\mu$ F; 0805 $\geq$ 0.33 $\mu$ F; 1206 $\geq$ 1 $\mu$ F; 1210 $\geq$ 4.7 $\mu$ F
16V	$\leq$ 9%	$\leq$ 12.5%	0603 $\geq$ 2.2 $\mu$ F; 0805 $\geq$ 3.3 $\mu$ F; 1206 $\geq$ 10 $\mu$ F; 1210 $\geq$ 22 $\mu$ F; 1812 $\geq$ 47 $\mu$ F			
10V	$\leq$ 12.5%	$\leq$ 16%	0603 $\geq$ 2.2 $\mu$ F; 0805 $\geq$ 3.3 $\mu$ F; 1206 $\geq$ 4.7 $\mu$ F; 1210 $\geq$ 10 $\mu$ F; 1812 $\geq$ 47 $\mu$ F			
6.3V	$\leq$ 16%					



# General Purpose Ceramic Capacitors (C Series)

## Environmental Test Criteria

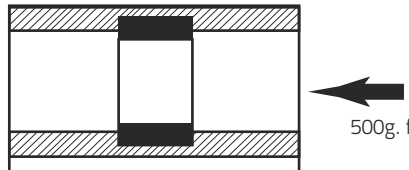
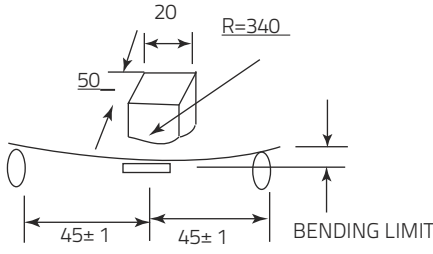
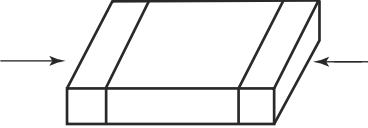
NO	ITEM		PERFORMANCE		TEST CONDITION																		
7	CAPACITANCE TEMPERATURE COEFFICIENT	CLASS I	CHARACTERISTIC	TEMP. COEFFICIENT (PPM/°C)	THESE SYMMETRICAL TOLERANCE APPLY TO 2 POINT MEASUREMENT OF TEMPERATURE COEFFICIENT: ONE AT -25°C AND AT 85°C																		
			COG/NPO	0 ± 60 (±30)	STEP	TEMPERATURE (°C)																	
				-150 ± 60	1	25 ± 2																	
				-220 ± 60	2	MIN RATED TEMP ± 2																	
				-330 ± 60	3	25 ± 2																	
				-470 ± 60	4	MAX RATED TEMP ± 2																	
				-750 ± 120	5	25 ± 2																	
+350 ~ -1000																							
8	TEMPERATURE CHARACTERISTICS	CLASS II	CAPACITANCE CHANGE		<table border="1"> <thead> <tr> <th>STEP</th> <th>TEMP. (°C) B</th> <th>TEMP. (°C) F</th> </tr> </thead> <tbody> <tr> <td>1</td> <td>25 ± 2</td> <td>25 ± 2</td> </tr> <tr> <td>2</td> <td>-55 ± 2</td> <td>-25 ± 2</td> </tr> <tr> <td>3</td> <td>25 ± 2</td> <td>25 ± 2</td> </tr> <tr> <td>4</td> <td>125 ± 2</td> <td>85 ± 2</td> </tr> <tr> <td>5</td> <td>25 ± 2</td> <td>25 ± 2</td> </tr> </tbody> </table>	STEP	TEMP. (°C) B	TEMP. (°C) F	1	25 ± 2	25 ± 2	2	-55 ± 2	-25 ± 2	3	25 ± 2	25 ± 2	4	125 ± 2	85 ± 2	5	25 ± 2	25 ± 2
			STEP	TEMP. (°C) B		TEMP. (°C) F																	
			1	25 ± 2		25 ± 2																	
			2	-55 ± 2		-25 ± 2																	
			3	25 ± 2		25 ± 2																	
			4	125 ± 2		85 ± 2																	
			5	25 ± 2		25 ± 2																	
CHAR.	CAP. CHANGE (%)	$\frac{C2 - C1}{C1} \times 100\%$ <p>C1: CAPACITANCE AT STANDARD TEMPERATURE (25°C) C2: CAPACITANCE AT EACH TEMPERATURE</p>																					
X	X7R			±15%																			
	X6S			±22%																			
	X5R			±15%																			
Y	Y5V			-82% ~ +22%																			
	Z5U			-56% ~ +22%																			
9	ADHESIVE STRENGTH OF TERMINATION			NO INDICATION OF PEELING SHALL OCCUR ON THE TERMINAL ELECTRODE		<p>A 500g.f PRESSURE SHALL BE APPLIED FOR 10±1 SECOND</p> 																	
10	BENDING STRENGTH	APPEARANCE	NO MECHANICAL DAMAGE SHALL OCCURE		<p>BENDING SHALL BE APPLIED TO THE LIMIT (1mm) WITH 0.3mm/SEC</p> 																		
		CAPACITANCE	CHARACTER	CHANGE OF CAPACITANCE																			
			CLASS I				WITHIN ±5% OR ±0.5pF WHICHEVER IS LARGER																
			CLASS II	X (X7R, X6S, X5R)			WITHIN ±12.5%																
Y (Y5V, Z5U)	WITHIN ±30%																						
11	SOLDERABILITY	MORE THAN 95% OF THE TERMINAL SURFACE IS TO BE SOLDERED NEWLY, SO METAL PART (A) DOES NOT COME OUT OR DISSOLVE		<p>SOLDER TEMPERATURE : 230 ± 5 °C SOLDER: H63A FLUX: ROSIN PRE-HEATING: AT 80 ~ 120 °C FOR 10 ~ 30 SEC.</p> 																			

# General Purpose Ceramic Capacitors (C Series)

## Environmental Test Criteria

NO	ITEM	PERFORMANCE	TEST CONDITION									
12	RESISTANCE TO SOLDERING HEAT	APPEARANCE	NO MECHANICAL DAMAGE SHALL OCCUR									
		CAPACITANCE	CHARACTERISTIC	CAP. CHANGE								
			CLASS I	WITHIN $\pm 2.5\%$ OR $\pm 0.25$ pF WHICHEVER IS LARGER								
			CLASS II	X	WITHIN $\pm 7.5\%$							
		Y		WITHIN $\pm 20\%$								
		QCLASS I	30 pF AND OVER: Q 1000 LESS THAN 30 pF: Q 400 + 20xC									
		Tan CLASS II	TO SATISFY THE SPECIFIED INITIAL VLUE									
		INSULATION RESISTANCE	TO SATISFY THE SPECIFIED INITIAL VLUE									
WITHSTANDING VOLTAGE	TO SATISFY THE SPECIFIED INITIAL VLUE											
13	VIBRATION TEST	APPEARANCE	NO MECHANICAL DAMAGE SHALL OCCUR									
		CAPACITANCE	CHARACTERISTIC	CAP. CHANGE								
			CLASS I	WITHIN $\pm 2.5\%$ OR $\pm 0.25$ pF WHICHEVER IS LARGER								
			CLASS II	X	WITHIN $\pm 5\%$							
		Y		WITHIN $\pm 20\%$								
		QCLASS I	30 pF AND OVER: Q 1000 LESS THAN 30 pF: Q 400 + 20xC									
		Tan CLASS II	TO SATISFY THE SPECIFIED INITIAL VALUE									
		INSULATION RESISTANCE	TO SATISFY THE SPECIFIED INITIAL VALUE									
			<p>DIP : SOLDER TEMPERATURE OF <math>270 \pm 5</math> °C DIP TIME : <math>10 \pm 1</math> SEC. EACH TERMINATION SHALL BE FULLY IMMERSED AND PREHEATED AS FOLLOWING:</p> <table border="1"> <thead> <tr> <th>STEP</th> <th>TEMP. (°C)</th> <th>TIME (SEC.)</th> </tr> </thead> <tbody> <tr> <td>1</td> <td>80~100</td> <td>60</td> </tr> <tr> <td>2</td> <td>150~180</td> <td>60</td> </tr> </tbody> </table> <p>MEASURE AT ROOM TEMP. AFTER COOLING FOR CLASS I : <math>24 \pm 2</math> HOURS CLASS II : <math>48 \pm 4</math> HOURS</p>	STEP	TEMP. (°C)	TIME (SEC.)	1	80~100	60	2	150~180	60
STEP	TEMP. (°C)	TIME (SEC.)										
1	80~100	60										
2	150~180	60										
			<p>THE CAPACITOR SHALL BE SUBJECTED TO A HARMONIC MOTION HAVING A TOTAL AMPLITUDE of 1.5mm.</p> <p>THE ENTIRE FREQUENCY RANGE, FROM 10 TO 55Hz AND RETURN TO 10Hz SHALL BE TRAVERSED IN 1 MINUTE.</p> <p>THIS CYCLE SHALL BE PERFORMED 2 HOURS IN EACH THREE MUTUALLY PERPENDICULAR DIRECTION, FOR TOTAL PERIOD of 6 HOURS.</p>									

# General Purpose Ceramic Capacitors (C Series)

## Environmental Test Criteria

NO	ITEM	PERFORMANCE	TEST CONDITION			
14	APPEARANCE	NO MECHANICAL DAMAGE SHALL OCCUR	TEMPERATURE : 40±2 °C RELATIVE HUMIDITY: 90~95 %RH TEST TIME : 500 +12/-0 Hr.  MEASURE AT ROOM TEMPERATURE AFTER COOLING FOR CLASS I : 24±2 Hr. CLASS II : 48±4 Hr.  SEE (FIG.3)			
	CAPACITANCE	CHARACTERISTIC		CAPACITANCE CHANGE		
		CLASS I		WITHIN ±5% OR±0.5pF WHICHEVER IS LARGER		
		CLASS II		X	WITHIN ±12.5%	
				Y	WITHIN ±30%	
	QCLASS I	30pF AND OVER : Q 350 10 ~ 30pF : Q 275 + 2.5xC LESS THAN 10pF : Q 200 + 10xC				
	DISSIPATION FACTOR (Tan $\theta$ CLASS II)	<b>X7R, X6S, X5R</b>				
		<b>Rated Voltage</b>		<b>D.F.</b>	<b>Exception of D.F.</b>	
		≥50V		≤2.5%	≤3%	0201 (50V); 0603≥0.047uF 0805≥0.22uF; 1206≥0.47uF
					≤5%	0603≥1uF; 0805≥1uF; 1206≥4.7uF; 1210≥4.7uF
25V		≤2.5%	≤5%	0201≥0.01uF; 0805≥1uF; 1210≥4.7uF		
			≤10%	0402≥0.10uF; 0603≥0.33uF; 0805≥2.2uF 1206≥4.7uF; 1210≥22uF		
16V		≤3.5%	≤5%	0201≥0.01uF; 0402≥0.033uF; 0805≥0.68uF; 1206≥2.2uF; 1210≥4.7uF		
			≤10%	0402≥0.47uF; 0603≥0.68uF; 0805≥2.2uF; 1206≥4.7uF; 1210≥22uF		
10V		≤5%	≤10%	0402≥0.33uF; 0603≥0.33uF; 0805≥2.2uF; 1206≥2.2uF; 1210≥22uF		
6.3V		≤10%				
<b>Y5V, Z5U</b>						
<b>Rated Voltage</b>	<b>D.F.</b>	<b>Exception of D.F.</b>				
≥50V	≤5%	≤9%	0603≥0.1uF; 0805≥0.47uF; 1206≥4.7uF;			
25V	≤5%	≤9%	0402≥0.047uF; 0603≥0.1uF; 0805≥0.33uF; 1206≥1uF; 1210≥4.7uF			
16V	≤9%	≤12.5%	0603≥2.2uF; 0805≥3.3uF; 1206≥10uF; 1210≥22uF; 1812≥47uF			
10V	≤12.5%	≤16%	0603≥2.2uF; 0805≥3.3uF; 1206≥4.7uF; 1210≥10uF; 1812≥47uF			
6.3V	≤16%					
INSULATION RESISTANCE	MINIMUM INSULATION RESISTANCE: 1,000 M OR 50M .μF PRODUCT WHICHEVER IS SMALLER					

# General Purpose Ceramic Capacitors (C Series)

## Environmental Test Criteria

NO	ITEM	PERFORMANCE	TEST CONDITION																																
15	APPEARANCE	NO MECHANICAL DAMAGE SHALL OCCUR	<p>APPLIED VOLTAGE: RATED VOLTAGE TEMPERATURE : 40±2 °C RELATIVE HUMIDITY: 90~95%RH TEST TIME : 500 +12/-0 Hr. CURRENT APPLIED: 50mA MAX.</p> <p>MEASURING AT ROOM TEMPERATURE AFTER COOLING FOR CLASS I : 24±2 Hr. CLASS II : 48±4 Hr.</p> <p>SEE (FIG.3)</p>																																
	CAPACITANCE	CHARACTERISTIC		CAPACITANCE CHANGE																															
		CLASS I		WITHIN ±7.5% OR±0.75pF WHICHEVER IS LARGER																															
		CLASS II		X	WITHIN ±12.5%																														
	Y			WITHIN ±30%																															
	QCLASS I	30pF AND OVER : Q 200 30pF AND BELOW : Q 100+ 10/3xC																																	
	MOISTURE RESISTANCE	DISSIPATION FACTOR (Tan $\theta$ CLASS II)		<b>X7R, X6S, X5R</b> <table border="1"> <thead> <tr> <th>Rated Voltage</th> <th>D.F.</th> <th colspan="2">Exception of D.F.</th> </tr> </thead> <tbody> <tr> <td rowspan="2">≥50V</td> <td rowspan="2">≤2.5%</td> <td>≤3%</td> <td>0201 (50V); 0603≥0.047uF 0805≥0.22uF; 1206≥0.47uF</td> </tr> <tr> <td>≤5%</td> <td>0603≥1uF; 0805≥1uF; 1206≥4.7uF; 1210≥4.7uF</td> </tr> <tr> <td rowspan="2">25V</td> <td rowspan="2">≤2.5%</td> <td>≤5%</td> <td>0201≥0.01uF; 0805≥1uF; 1210≥4.7uF</td> </tr> <tr> <td>≤10%</td> <td>0402≥0.10uF; 0603≥0.33uF; 0805≥2.2uF 1206≥4.7uF; 1210≥22uF</td> </tr> <tr> <td rowspan="2">16V</td> <td rowspan="2">≤3.5%</td> <td>≤5%</td> <td>0201≥0.01uF; 0402≥0.033uF; 0805≥0.68uF; 1206≥2.2uF; 1210≥4.7uF</td> </tr> <tr> <td>≤10%</td> <td>0402≥0.47uF; 0603≥0.68uF; 0805≥2.2uF; 1206≥4.7uF; 1210≥22uF</td> </tr> <tr> <td>10V</td> <td>≤5%</td> <td>≤10%</td> <td>0402≥0.33uF; 0603≥0.33uF; 0805≥2.2uF; 1206≥2.2uF; 1210≥22uF</td> </tr> <tr> <td>6.3V</td> <td>≤10%</td> <td></td> <td></td> </tr> </tbody> </table>		Rated Voltage	D.F.	Exception of D.F.		≥50V	≤2.5%	≤3%	0201 (50V); 0603≥0.047uF 0805≥0.22uF; 1206≥0.47uF	≤5%	0603≥1uF; 0805≥1uF; 1206≥4.7uF; 1210≥4.7uF	25V	≤2.5%	≤5%	0201≥0.01uF; 0805≥1uF; 1210≥4.7uF	≤10%	0402≥0.10uF; 0603≥0.33uF; 0805≥2.2uF 1206≥4.7uF; 1210≥22uF	16V	≤3.5%	≤5%	0201≥0.01uF; 0402≥0.033uF; 0805≥0.68uF; 1206≥2.2uF; 1210≥4.7uF	≤10%	0402≥0.47uF; 0603≥0.68uF; 0805≥2.2uF; 1206≥4.7uF; 1210≥22uF	10V	≤5%	≤10%	0402≥0.33uF; 0603≥0.33uF; 0805≥2.2uF; 1206≥2.2uF; 1210≥22uF	6.3V	≤10%		
				Rated Voltage	D.F.	Exception of D.F.																													
	≥50V	≤2.5%		≤3%	0201 (50V); 0603≥0.047uF 0805≥0.22uF; 1206≥0.47uF																														
				≤5%	0603≥1uF; 0805≥1uF; 1206≥4.7uF; 1210≥4.7uF																														
25V	≤2.5%	≤5%	0201≥0.01uF; 0805≥1uF; 1210≥4.7uF																																
		≤10%	0402≥0.10uF; 0603≥0.33uF; 0805≥2.2uF 1206≥4.7uF; 1210≥22uF																																
16V	≤3.5%	≤5%	0201≥0.01uF; 0402≥0.033uF; 0805≥0.68uF; 1206≥2.2uF; 1210≥4.7uF																																
		≤10%	0402≥0.47uF; 0603≥0.68uF; 0805≥2.2uF; 1206≥4.7uF; 1210≥22uF																																
10V	≤5%	≤10%	0402≥0.33uF; 0603≥0.33uF; 0805≥2.2uF; 1206≥2.2uF; 1210≥22uF																																
6.3V	≤10%																																		
		<b>Y5V, Z5U</b> <table border="1"> <thead> <tr> <th>Rated Voltage</th> <th>D.F.</th> <th colspan="2">Exception of D.F.</th> </tr> </thead> <tbody> <tr> <td>≥50V</td> <td>≤5%</td> <td>≤9%</td> <td>0603≥0.1uF; 0805≥0.47uF; 1206≥4.7uF;</td> </tr> <tr> <td rowspan="2">25V</td> <td rowspan="2">≤5%</td> <td>≤9%</td> <td>0402≥0.047uF; 0603≥0.1uF; 0805≥0.33uF; 1206≥1uF; 1210≥4.7uF</td> </tr> <tr> <td>≤12.5%</td> <td>0603≥2.2uF; 0805≥3.3uF; 1206≥10uF; 1210≥22uF; 1812≥47uF</td> </tr> <tr> <td rowspan="2">16V</td> <td rowspan="2">≤9%</td> <td>≤16%</td> <td>0603≥2.2uF; 0805≥3.3uF; 1206≥4.7uF; 1210≥10uF; 1812≥47uF</td> </tr> <tr> <td>≤16%</td> <td></td> </tr> </tbody> </table>		Rated Voltage	D.F.	Exception of D.F.		≥50V	≤5%	≤9%	0603≥0.1uF; 0805≥0.47uF; 1206≥4.7uF;	25V	≤5%	≤9%	0402≥0.047uF; 0603≥0.1uF; 0805≥0.33uF; 1206≥1uF; 1210≥4.7uF	≤12.5%	0603≥2.2uF; 0805≥3.3uF; 1206≥10uF; 1210≥22uF; 1812≥47uF	16V	≤9%	≤16%	0603≥2.2uF; 0805≥3.3uF; 1206≥4.7uF; 1210≥10uF; 1812≥47uF	≤16%													
Rated Voltage	D.F.	Exception of D.F.																																	
≥50V	≤5%	≤9%	0603≥0.1uF; 0805≥0.47uF; 1206≥4.7uF;																																
25V	≤5%	≤9%	0402≥0.047uF; 0603≥0.1uF; 0805≥0.33uF; 1206≥1uF; 1210≥4.7uF																																
		≤12.5%	0603≥2.2uF; 0805≥3.3uF; 1206≥10uF; 1210≥22uF; 1812≥47uF																																
16V	≤9%	≤16%	0603≥2.2uF; 0805≥3.3uF; 1206≥4.7uF; 1210≥10uF; 1812≥47uF																																
		≤16%																																	
INSULATION RESISTANCE	MINIMUM INSULATION RESISTANCE: 100 M OR 25M .μF PRODUCT, WHICHEVER IS SMALLER																																		

# General Purpose Ceramic Capacitors (C Series)

## Environmental Test Criteria

NO	ITEM	PERFORMANCE	TEST CONDITION			
16	APPEARANCE	NO MECHANICAL DAMAGE SHALL OCCUR	APPLIED VOLTAGE: 200% OF RATED VOLTAGE TEST TIME : 1000 +48/-0 Hr. CURRENT APPLIED: 50mA MAX.			
	CAPACITANCE	CHARACTERISTIC		CAP. CHANGE		
		CLASS I		WITHIN $\pm 3\%$ OR $\pm 0.3\text{pF}$ , WHICHEVER IS LARGER		
	CLASS II	X	WITHIN $\pm 12.5\%$	CHAR.	TEMP.	
		Y	WITHIN $\pm 30\%$	CLASS I	125 $\pm 3$ °C	
	QCLASS I	30pF AND OVER : Q 350 10 - 30 pF : Q 275 + 2.5xC LESS THAN 10pF : Q 200 + 10xC	CLASS II	X	125 $\pm 3$ °C	
	DISSIPATION FACTOR (Tan $\theta$ CLASS II)	HIGH TEMPERATURE RESISTANCE	X7R, X6S, X5R			
			Rated Voltage	D.F.	Exception of D.F.	
			$\geq 50\text{V}$	$\leq 2.5\%$	$\leq 3\%$	0201 (50V); 0603 $\geq 0.047\mu\text{F}$ 0805 $\geq 0.22\mu\text{F}$ ; 1206 $\geq 0.47\mu\text{F}$
					$\leq 5\%$	0603 $\geq 1\mu\text{F}$ ; 0805 $\geq 1\mu\text{F}$ ; 1206 $\geq 4.7\mu\text{F}$ ; 1210 $\geq 4.7\mu\text{F}$
25V			$\leq 2.5\%$	$\leq 5\%$	0201 $\geq 0.01\mu\text{F}$ ; 0805 $\geq 1\mu\text{F}$ ; 1210 $\geq 4.7\mu\text{F}$	
				$\leq 10\%$	0402 $\geq 0.10\mu\text{F}$ ; 0603 $\geq 0.33\mu\text{F}$ ; 0805 $\geq 2.2\mu\text{F}$ 1206 $\geq 4.7\mu\text{F}$ ; 1210 $\geq 22\mu\text{F}$	
16V			$\leq 3.5\%$	$\leq 5\%$	0201 $\geq 0.01\mu\text{F}$ ; 0402 $\geq 0.033\mu\text{F}$ ; 0805 $\geq 0.68\mu\text{F}$ ; 1206 $\geq 2.2\mu\text{F}$ ; 1210 $\geq 4.7\mu\text{F}$	
				$\leq 10\%$	0402 $\geq 0.47\mu\text{F}$ ; 0603 $\geq 0.68\mu\text{F}$ ; 0805 $\geq 2.2\mu\text{F}$ ; 1206 $\geq 4.7\mu\text{F}$ ; 1210 $\geq 22\mu\text{F}$	
10V			$\leq 5\%$	$\leq 10\%$	0402 $\geq 0.33\mu\text{F}$ ; 0603 $\geq 0.33\mu\text{F}$ ; 0805 $\geq 2.2\mu\text{F}$ ; 1206 $\geq 2.2\mu\text{F}$ ; 1210 $\geq 22\mu\text{F}$	
6.3V			$\leq 10\%$			
Y5V, Z5U						
Rated Voltage	D.F.	Exception of D.F.				
$\geq 50\text{V}$	$\leq 5\%$	$\leq 9\%$	0603 $\geq 0.1\mu\text{F}$ ; 0805 $\geq 0.47\mu\text{F}$ ; 1206 $\geq 4.7\mu\text{F}$ ;			
25V	$\leq 5\%$	$\leq 9\%$	0402 $\geq 0.047\mu\text{F}$ ; 0603 $\geq 0.1\mu\text{F}$ ; 0805 $\geq 0.33\mu\text{F}$ ; 1206 $\geq 1\mu\text{F}$ ; 1210 $\geq 4.7\mu\text{F}$			
16V	$\leq 9\%$	$\leq 12.5\%$	0603 $\geq 2.2\mu\text{F}$ ; 0805 $\geq 3.3\mu\text{F}$ ; 1206 $\geq 10\mu\text{F}$ ; 1210 $\geq 22\mu\text{F}$ ; 1812 $\geq 47\mu\text{F}$			
10V	$\leq 12.5\%$	$\leq 16\%$	0603 $\geq 2.2\mu\text{F}$ ; 0805 $\geq 3.3\mu\text{F}$ ; 1206 $\geq 4.7\mu\text{F}$ ; 1210 $\geq 10\mu\text{F}$ ; 1812 $\geq 47\mu\text{F}$			
6.3V	$\leq 16\%$					
INSULATION RESISTANCE	MINIMUM INSULATION RESISTANCE: 1,000M OR 50M. $\mu\text{F}$ PRODUCT WHICHEVER IS SMALLER					
			(INITIAL VALUE MEASUREMENT) FOR CLASS II CAPACITORS, 200 % OF RATED VOLTAGE SHALL BE APPLIED FOR 1 HOUR AT THE MAXIMUM OPERATING TEMPERATURE, THEN KEEP IT AT ROOM TEMPERATURE. FOR 48 $\pm 4$ Hrs. SEE (FIG.3)			

# General Purpose Ceramic Capacitors (C Series)

## Tape and Reel Specifications

NO	ITEM	PERFORMANCE	TEST CONDITION																														
17	APPEARANCE	NO MECHANICAL DAMAGE SHALL OCCUR	CAPACITORS SHALL BE SUBJECTED TO FIVE CYCLES OF THE TEMPERATURE CYCLE AS FOLLOWING																														
	CAPACITANCE	CHARACTERISTIC		CAP. CHANGE																													
		CLASS I		WITHIN $\pm 2.5\%$ OR $\pm 0.25\text{pF}$ WHICHEVER IS LARGER																													
		CLASS II		WITHIN $\pm 7.5\%$																													
		X	WITHIN $\pm 7.5\%$	STEP	TEMP.(°C)	TIME (MIN)																											
		Y	WITHIN $\pm 20\%$	1	MIN. RATED TEMP. +0/-3	30																											
	QCLASS I	30 pF AND OVER : Q 1000 LESS THAN 30pF:Q 400+20xC	2	25	2 ~ 3																												
	TEMPERATURE CYCLE	TAN CLASS II	X7R, X6S, X5R	3	MAX. RATED TEMP. +3/-0	30																											
				4	25	2 ~ 3																											
			<table border="1"> <thead> <tr> <th>Rated Voltage</th> <th>D.F.</th> <th colspan="2">Exception of D.F.</th> </tr> </thead> <tbody> <tr> <td rowspan="2"><math>\geq 50\text{V}</math></td> <td rowspan="2"><math>\leq 2.5\%</math></td> <td><math>\leq 3\%</math></td> <td>0201 (50V); 0603<math>\geq 0.047\mu\text{F}</math> 0805<math>\geq 0.22\mu\text{F}</math>; 1206<math>\geq 0.47\mu\text{F}</math></td> </tr> <tr> <td><math>\leq 5\%</math></td> <td>0603<math>\geq 1\mu\text{F}</math>; 0805<math>\geq 1\mu\text{F}</math>; 1206<math>\geq 4.7\mu\text{F}</math>; 1210<math>\geq 4.7\mu\text{F}</math></td> </tr> <tr> <td rowspan="2">25V</td> <td rowspan="2"><math>\leq 2.5\%</math></td> <td><math>\leq 5\%</math></td> <td>0201<math>\geq 0.01\mu\text{F}</math>; 0805<math>\geq 1\mu\text{F}</math>; 1210<math>\geq 4.7\mu\text{F}</math></td> </tr> <tr> <td><math>\leq 10\%</math></td> <td>0402<math>\geq 0.10\mu\text{F}</math>; 0603<math>\geq 0.33\mu\text{F}</math>; 0805<math>\geq 2.2\mu\text{F}</math> 1206<math>\geq 4.7\mu\text{F}</math>; 1210<math>\geq 22\mu\text{F}</math></td> </tr> <tr> <td rowspan="2">16V</td> <td rowspan="2"><math>\leq 3.5\%</math></td> <td><math>\leq 5\%</math></td> <td>0201<math>\geq 0.01\mu\text{F}</math>; 0402<math>\geq 0.033\mu\text{F}</math>; 0805<math>\geq 0.68\mu\text{F}</math>; 1206<math>\geq 2.2\mu\text{F}</math>; 1210<math>\geq 4.7\mu\text{F}</math></td> </tr> <tr> <td><math>\leq 10\%</math></td> <td>0402<math>\geq 0.47\mu\text{F}</math>; 0603<math>\geq 0.68\mu\text{F}</math>; 0805<math>\geq 2.2\mu\text{F}</math>; 1206<math>\geq 4.7\mu\text{F}</math>; 1210<math>\geq 22\mu\text{F}</math></td> </tr> <tr> <td>10V</td> <td><math>\leq 5\%</math></td> <td><math>\leq 10\%</math></td> <td>0402<math>\geq 0.33\mu\text{F}</math>; 0603<math>\geq 0.33\mu\text{F}</math>; 0805<math>\geq 2.2\mu\text{F}</math>; 1206<math>\geq 2.2\mu\text{F}</math>; 1210<math>\geq 22\mu\text{F}</math></td> </tr> <tr> <td>6.3V</td> <td><math>\leq 10\%</math></td> <td></td> <td></td> </tr> </tbody> </table>	Rated Voltage	D.F.	Exception of D.F.		$\geq 50\text{V}$	$\leq 2.5\%$	$\leq 3\%$	0201 (50V); 0603 $\geq 0.047\mu\text{F}$ 0805 $\geq 0.22\mu\text{F}$ ; 1206 $\geq 0.47\mu\text{F}$	$\leq 5\%$	0603 $\geq 1\mu\text{F}$ ; 0805 $\geq 1\mu\text{F}$ ; 1206 $\geq 4.7\mu\text{F}$ ; 1210 $\geq 4.7\mu\text{F}$	25V	$\leq 2.5\%$	$\leq 5\%$	0201 $\geq 0.01\mu\text{F}$ ; 0805 $\geq 1\mu\text{F}$ ; 1210 $\geq 4.7\mu\text{F}$	$\leq 10\%$	0402 $\geq 0.10\mu\text{F}$ ; 0603 $\geq 0.33\mu\text{F}$ ; 0805 $\geq 2.2\mu\text{F}$ 1206 $\geq 4.7\mu\text{F}$ ; 1210 $\geq 22\mu\text{F}$	16V	$\leq 3.5\%$	$\leq 5\%$	0201 $\geq 0.01\mu\text{F}$ ; 0402 $\geq 0.033\mu\text{F}$ ; 0805 $\geq 0.68\mu\text{F}$ ; 1206 $\geq 2.2\mu\text{F}$ ; 1210 $\geq 4.7\mu\text{F}$	$\leq 10\%$	0402 $\geq 0.47\mu\text{F}$ ; 0603 $\geq 0.68\mu\text{F}$ ; 0805 $\geq 2.2\mu\text{F}$ ; 1206 $\geq 4.7\mu\text{F}$ ; 1210 $\geq 22\mu\text{F}$	10V	$\leq 5\%$	$\leq 10\%$	0402 $\geq 0.33\mu\text{F}$ ; 0603 $\geq 0.33\mu\text{F}$ ; 0805 $\geq 2.2\mu\text{F}$ ; 1206 $\geq 2.2\mu\text{F}$ ; 1210 $\geq 22\mu\text{F}$	6.3V	$\leq 10\%$		
Rated Voltage			D.F.	Exception of D.F.																													
$\geq 50\text{V}$			$\leq 2.5\%$	$\leq 3\%$	0201 (50V); 0603 $\geq 0.047\mu\text{F}$ 0805 $\geq 0.22\mu\text{F}$ ; 1206 $\geq 0.47\mu\text{F}$																												
				$\leq 5\%$	0603 $\geq 1\mu\text{F}$ ; 0805 $\geq 1\mu\text{F}$ ; 1206 $\geq 4.7\mu\text{F}$ ; 1210 $\geq 4.7\mu\text{F}$																												
25V			$\leq 2.5\%$	$\leq 5\%$	0201 $\geq 0.01\mu\text{F}$ ; 0805 $\geq 1\mu\text{F}$ ; 1210 $\geq 4.7\mu\text{F}$																												
				$\leq 10\%$	0402 $\geq 0.10\mu\text{F}$ ; 0603 $\geq 0.33\mu\text{F}$ ; 0805 $\geq 2.2\mu\text{F}$ 1206 $\geq 4.7\mu\text{F}$ ; 1210 $\geq 22\mu\text{F}$																												
16V			$\leq 3.5\%$	$\leq 5\%$	0201 $\geq 0.01\mu\text{F}$ ; 0402 $\geq 0.033\mu\text{F}$ ; 0805 $\geq 0.68\mu\text{F}$ ; 1206 $\geq 2.2\mu\text{F}$ ; 1210 $\geq 4.7\mu\text{F}$																												
				$\leq 10\%$	0402 $\geq 0.47\mu\text{F}$ ; 0603 $\geq 0.68\mu\text{F}$ ; 0805 $\geq 2.2\mu\text{F}$ ; 1206 $\geq 4.7\mu\text{F}$ ; 1210 $\geq 22\mu\text{F}$																												
10V	$\leq 5\%$	$\leq 10\%$	0402 $\geq 0.33\mu\text{F}$ ; 0603 $\geq 0.33\mu\text{F}$ ; 0805 $\geq 2.2\mu\text{F}$ ; 1206 $\geq 2.2\mu\text{F}$ ; 1210 $\geq 22\mu\text{F}$																														
6.3V	$\leq 10\%$																																
Y5V, Z5U	<table border="1"> <thead> <tr> <th>Rated Voltage</th> <th>D.F.</th> <th colspan="2">Exception of D.F.</th> </tr> </thead> <tbody> <tr> <td><math>\geq 50\text{V}</math></td> <td><math>\leq 5\%</math></td> <td><math>\leq 9\%</math></td> <td>0603<math>\geq 0.1\mu\text{F}</math>; 0805<math>\geq 0.47\mu\text{F}</math>; 1206<math>\geq 4.7\mu\text{F}</math>;</td> </tr> <tr> <td>25V</td> <td><math>\leq 5\%</math></td> <td><math>\leq 9\%</math></td> <td>0402<math>\geq 0.047\mu\text{F}</math>; 0603<math>\geq 0.1\mu\text{F}</math>; 0805<math>\geq 0.33\mu\text{F}</math>; 1206<math>\geq 1\mu\text{F}</math>; 1210<math>\geq 4.7\mu\text{F}</math></td> </tr> <tr> <td>16V</td> <td><math>\leq 9\%</math></td> <td><math>\leq 12.5\%</math></td> <td>0603<math>\geq 2.2\mu\text{F}</math>; 0805<math>\geq 3.3\mu\text{F}</math>; 1206<math>\geq 10\mu\text{F}</math>; 1210<math>\geq 22\mu\text{F}</math>; 1812<math>\geq 47\mu\text{F}</math></td> </tr> <tr> <td>10V</td> <td><math>\leq 12.5\%</math></td> <td><math>\leq 16\%</math></td> <td>0603<math>\geq 2.2\mu\text{F}</math>; 0805<math>\geq 3.3\mu\text{F}</math>; 1206<math>\geq 4.7\mu\text{F}</math>; 1210<math>\geq 10\mu\text{F}</math>; 1812<math>\geq 47\mu\text{F}</math></td> </tr> <tr> <td>6.3V</td> <td><math>\leq 16\%</math></td> <td></td> <td></td> </tr> </tbody> </table>	Rated Voltage	D.F.	Exception of D.F.		$\geq 50\text{V}$	$\leq 5\%$	$\leq 9\%$	0603 $\geq 0.1\mu\text{F}$ ; 0805 $\geq 0.47\mu\text{F}$ ; 1206 $\geq 4.7\mu\text{F}$ ;	25V	$\leq 5\%$	$\leq 9\%$	0402 $\geq 0.047\mu\text{F}$ ; 0603 $\geq 0.1\mu\text{F}$ ; 0805 $\geq 0.33\mu\text{F}$ ; 1206 $\geq 1\mu\text{F}$ ; 1210 $\geq 4.7\mu\text{F}$	16V	$\leq 9\%$	$\leq 12.5\%$	0603 $\geq 2.2\mu\text{F}$ ; 0805 $\geq 3.3\mu\text{F}$ ; 1206 $\geq 10\mu\text{F}$ ; 1210 $\geq 22\mu\text{F}$ ; 1812 $\geq 47\mu\text{F}$	10V	$\leq 12.5\%$	$\leq 16\%$	0603 $\geq 2.2\mu\text{F}$ ; 0805 $\geq 3.3\mu\text{F}$ ; 1206 $\geq 4.7\mu\text{F}$ ; 1210 $\geq 10\mu\text{F}$ ; 1812 $\geq 47\mu\text{F}$	6.3V	$\leq 16\%$										
Rated Voltage	D.F.	Exception of D.F.																															
$\geq 50\text{V}$	$\leq 5\%$	$\leq 9\%$	0603 $\geq 0.1\mu\text{F}$ ; 0805 $\geq 0.47\mu\text{F}$ ; 1206 $\geq 4.7\mu\text{F}$ ;																														
25V	$\leq 5\%$	$\leq 9\%$	0402 $\geq 0.047\mu\text{F}$ ; 0603 $\geq 0.1\mu\text{F}$ ; 0805 $\geq 0.33\mu\text{F}$ ; 1206 $\geq 1\mu\text{F}$ ; 1210 $\geq 4.7\mu\text{F}$																														
16V	$\leq 9\%$	$\leq 12.5\%$	0603 $\geq 2.2\mu\text{F}$ ; 0805 $\geq 3.3\mu\text{F}$ ; 1206 $\geq 10\mu\text{F}$ ; 1210 $\geq 22\mu\text{F}$ ; 1812 $\geq 47\mu\text{F}$																														
10V	$\leq 12.5\%$	$\leq 16\%$	0603 $\geq 2.2\mu\text{F}$ ; 0805 $\geq 3.3\mu\text{F}$ ; 1206 $\geq 4.7\mu\text{F}$ ; 1210 $\geq 10\mu\text{F}$ ; 1812 $\geq 47\mu\text{F}$																														
6.3V	$\leq 16\%$																																
INSULATION RESISTANCE	TO SATISFY THE SPECIFIED INITIAL VALUE																																

# General Purpose Ceramic Capacitors (C Series)

## Adhesive Strength of Termination

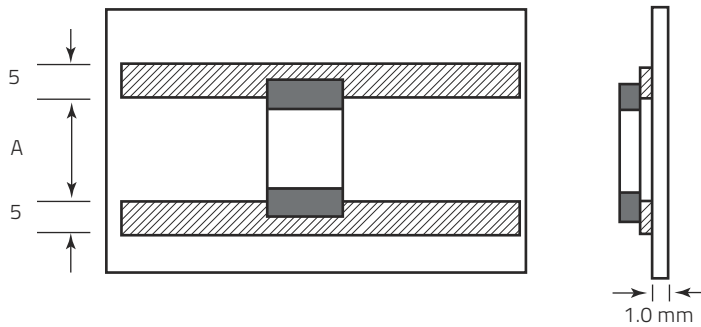

CODE	DIMENSION (mm)	A (mm)	CODE	DIMENSION (mm)	A (mm)
01005 (0402)	0.40 x 0.20	0.12	1206 (3216)	3.2 x 1.6	2.2
0201 (0603)	0.61 x 0.31	0.2	1210 (3225)	3.2 x 2.5	2.2
0402 (1005)	1.0 x 0.5	0.4	1812 (4532)	4.5 x 3.2	3.5
0603 (1608)	1.6 x 0.8	1.0	2220 (5750)	5.7 x 5.08	4.7
0805 (2012)	2.0 x 1.25	1.2			

 MATERIAL: ALUMINA SUBSTRATE (Al<sub>2</sub>O<sub>3</sub> 95% min) OR GLASS EPOXY SUBSTRATE

 COPPER FOIL ( t = 0.035mm)

## Substrate Bending Strength

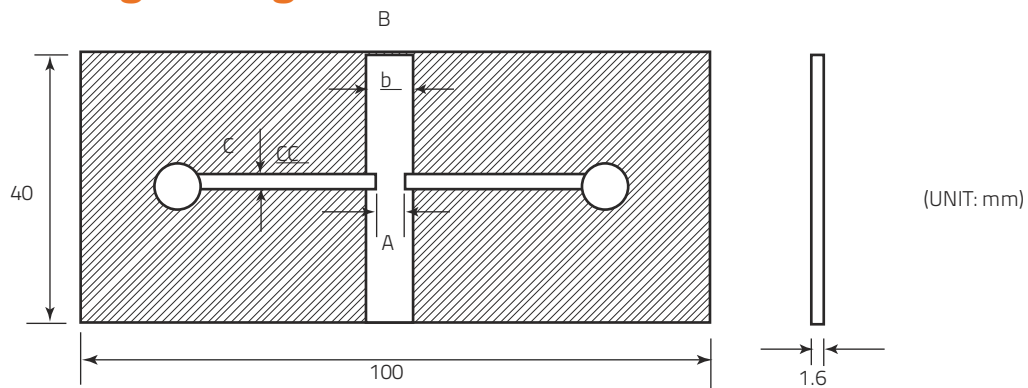

CODE	DIMENSION (mm)	A (mm)	B (mm)	C (mm)
01005 (0402)	0.40 x 0.20	0.12	0.7	0.20
0201 (0603)	0.61 x 0.31	0.2	1.0	0.4
0402 (1005)	1.0 x 0.5	0.4	1.4	0.5
0603 (1608)	1.6 x 0.8	1.0	3.0	1.0
0805 (2012)	2.0 x 1.25	1.2	4.0	1.65
1206 (3216)	3.2 x 1.6	2.2	5.0	2.0
1210 (3225)	3.2 x 2.5	2.2	5.0	3.2
1812 (4532)	4.5 x 3.2	3.5	7.0	4.0
2220 (5750)	5.7 x 5.08	4.7	8.5	5.0

MATERIAL: GLASS EPOXY SUBSTRATE

 COPPER FOIL ( t = 0.035mm)

 SOLDER RESIST

# General Purpose Ceramic Capacitors (C Series)

## Test Substrate

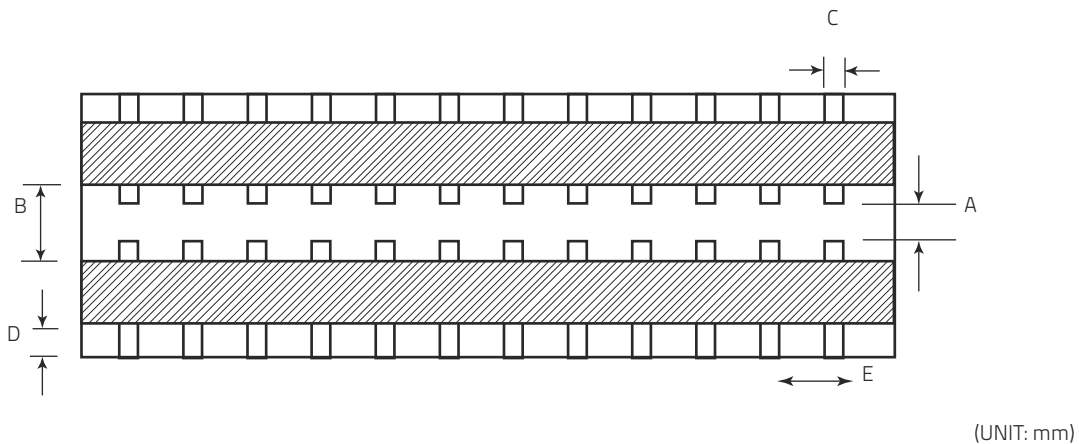

CODE	DIEMNSION (mm)	A	B	C	D	E
0201 (0603)	0.61 x 0.31	0.2	1.0	0.4	7.5	3.6
0402 (1005)	1.0 x 0.5	0.4	1.4	0.5	7.5	3.8
0603 (1608)	1.6 x 0.8	1.0	3.0	0.7	7.5	4.0
0805 (2012)	2.0 x 1.25	1.2	4.0	1.0	7.5	4.2
1206 (3216)	3.2 x 1.6	2.2	5.0	1.3	7.5	4.6
1210 (3225)	3.2 x 2.5	2.2	5.0	2.0	7.5	5.5
1812 (4532)	4.5 x 3.2	3.5	7.0	2.7	7.5	6.2
2220 (5750)	5.7 x 5.08	4.7	8.5	3.4	7.5	7.0

MATERIAL: GLASS EPOXY SUBSTRATE

