

TACT SWITCH DTS(M)(J)-6 SERIES

6x6 Surface Mounting Type (Ground Terminal Optional)

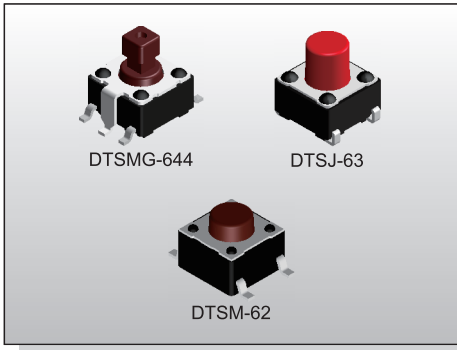

FEATURES

- ✘ 6x6mm, surface mounting type
- ✘ Optional ground pin
- ✘ Reflow solderable

APPLICATION

- ✘ Audio, OA equipment
- ✘ Instrumentation, Communication
- ✘ White goods

SPECIFICATION

| | |
|-----------------------|---|
| Contact Rating | 50mA, 12V DC |
| Contact Resistance | 100mΩ max. |
| Insulation Resistance | 100MΩ min. 500V DC |
| Dielectric Strength | 250V AC/1 minute |
| Operating Force | 100±50gf, Black(K) 160±50gf, Brown(N) 260±50gf, Red(R) 320±80gf, Salmon(S) 520±130gf, Yellow(Y) |
| Travel | 0.25mm |
| Operating Life | Phosphor Bronze Dome 50,000 cycles for 520/320gf 100,000 cycles for 260gf 200,000 cycles for 160/100 |
| | Stainless Steel Dome 300,000 cycles for 520/320gf 500,000 cycles for 260gf 1,000,000 cycles for 160/100gf |
| Operating Temp. | -25°C ~ +70°C |
| Storage Temp. | -30°C ~ +80°C |

HOW TO ORDER

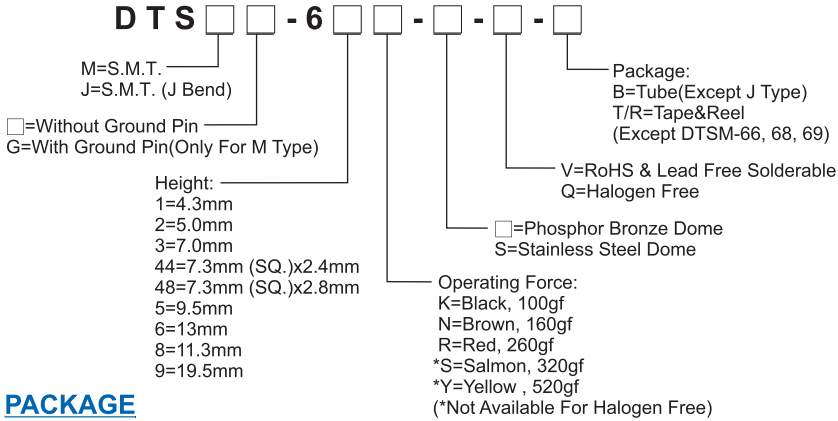

CIRCUIT

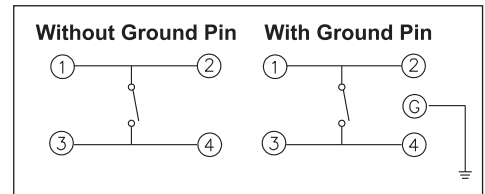

PACKAGE

<Tube>

77 pcs

<Tape & Reel>

DTSM(G)-61 / DTSMG-62:1000 pcs

DTSM-62:900 pcs

DTSM(G)-63, 64:700 pcs

DTSM(G)-65:380 pcs

DTSM-6

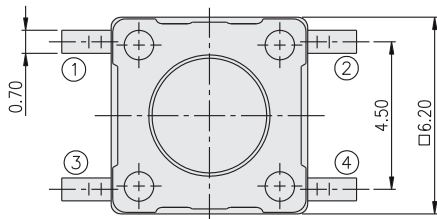

| PART NO. | H |
|----------|-------|
| DTSM-61 | 4.30 |
| DTSM-62 | 5.00 |
| DTSM-63 | 7.00 |
| DTSM-65 | 9.50 |
| DTSM-66 | 13.00 |
| DTSM-68 | 11.30 |
| DTSM-69 | 19.50 |

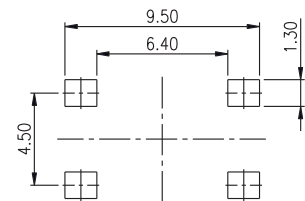
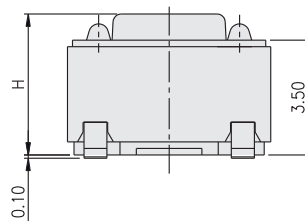
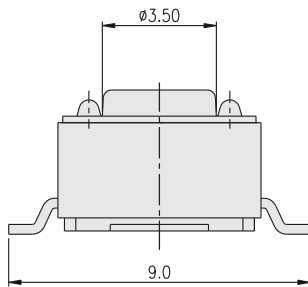

P.C.B. LAYOUT

DTSM-644(8)

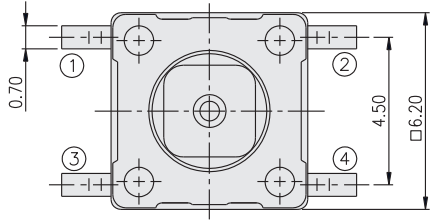

| PART NO. | □A | □B |
|----------|------|------|
| DTSM-644 | 2.40 | 1.60 |
| DTSM-648 | 2.80 | 2.00 |

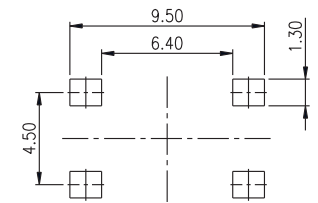
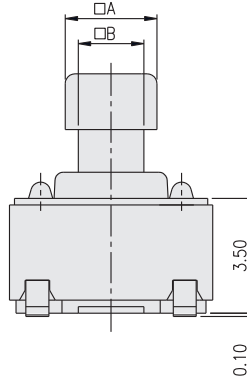
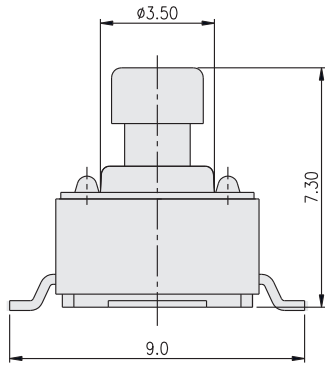

P.C.B. LAYOUT

TACT SWITCH

DTSMG-6

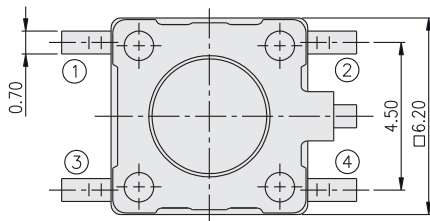

| PART NO. | H |
|----------|-------|
| DTSMG-61 | 4.30 |
| DTSMG-62 | 5.00 |
| DTSMG-63 | 7.00 |
| DTSMG-65 | 9.50 |
| DTSMG-66 | 13.00 |
| DTSMG-68 | 11.30 |
| DTSMG-69 | 19.50 |

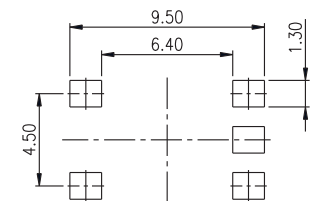
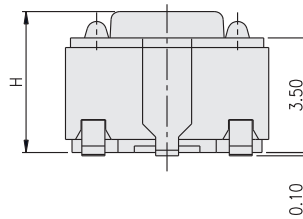
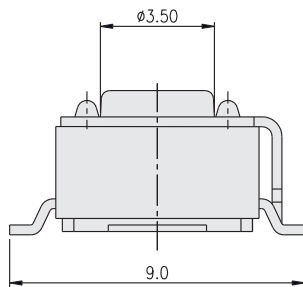

P.C.B. LAYOUT

TACT SWITCH
DTS(M)(J)-6 SERIES

**6x6 Surface Mounting Type
 (Ground Terminal Optional)**



DTSJ-6

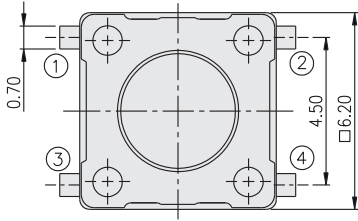

| PART NO. | H |
|----------|-------|
| DTSJ-61 | 4.30 |
| DTSJ-62 | 5.00 |
| DTSJ-63 | 7.00 |
| DTSJ-65 | 9.50 |
| DTSJ-66 | 13.00 |
| DTSJ-68 | 11.30 |
| DTSJ-69 | 19.50 |

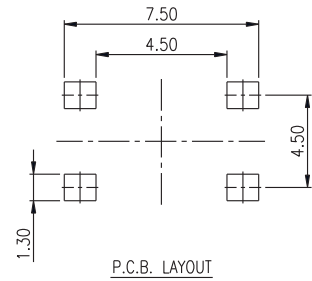
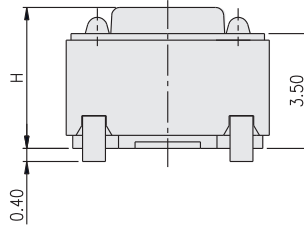
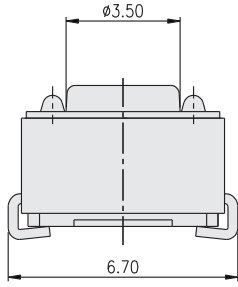

TACT SWITCH