

Lead-Free
SuperFlux LEDs

Technical Datasheet DS55



SuperFlux LEDs

Lead-Free

Introduction

The revolutionary package design allows lighting designers to reduce the number of LEDs required and provide a more uniform and unique illuminated appearance than with other LED products. This is possible through the efficient optical package design and high-current capabilities.

The low profile package can be easily coupled with reflectors or lenses to efficiently distribute light and provide the desired appearance. This product family includes red, red-orange and amber LEDs, allowing lighting designers to match the color of many lighting applications like vehicle signal lamps, specialty lighting, and electronic signs.

SuperFlux LEDs Feature

- Rugged package
- Energy saving
- Ease of handling
- Lead-Free
- RoHS Compliant
- High Luminance
- Uniform Color
- Low Power Consumption

PHILIPS
LUMILEDS

Table of Contents

General Information.....	3
Mechanical Dimensions	4
Selection Guide	5
Absolute Maximum Ratings	6
Optical Characteristics.....	7
Electrical Characteristics.....	8
Part Number Selection.....	9
Figures	12
Recommended Soldering Conditions for Pb-Free SuperFlux.....	16

General Information

Table I.

Color	Part Number
Red-Orange	HPWT-BH02
	HPWT-BH62
	HPWT-DH02
	HPWT-DH62
	HPWT-MH02
	HPWT-MH62
	HPWT-RH02
HPWT-RH62	
Amber	HPWT-BL02
	HPWT-BL62
	HPWT-DL02
	HPWT-DL62
	HPWT-ML02
	HPWT-ML62
	HPWT-RL02
HPWT-RL62	
Red	HPWT-BD02
	HPWT-BD62
	HPWT-DD02
	HPWT-DD62
	HPWT-MD02
	HPWT-MD62
	HPWT-RD02
HPWT-RD62	

Mechanical Dimensions

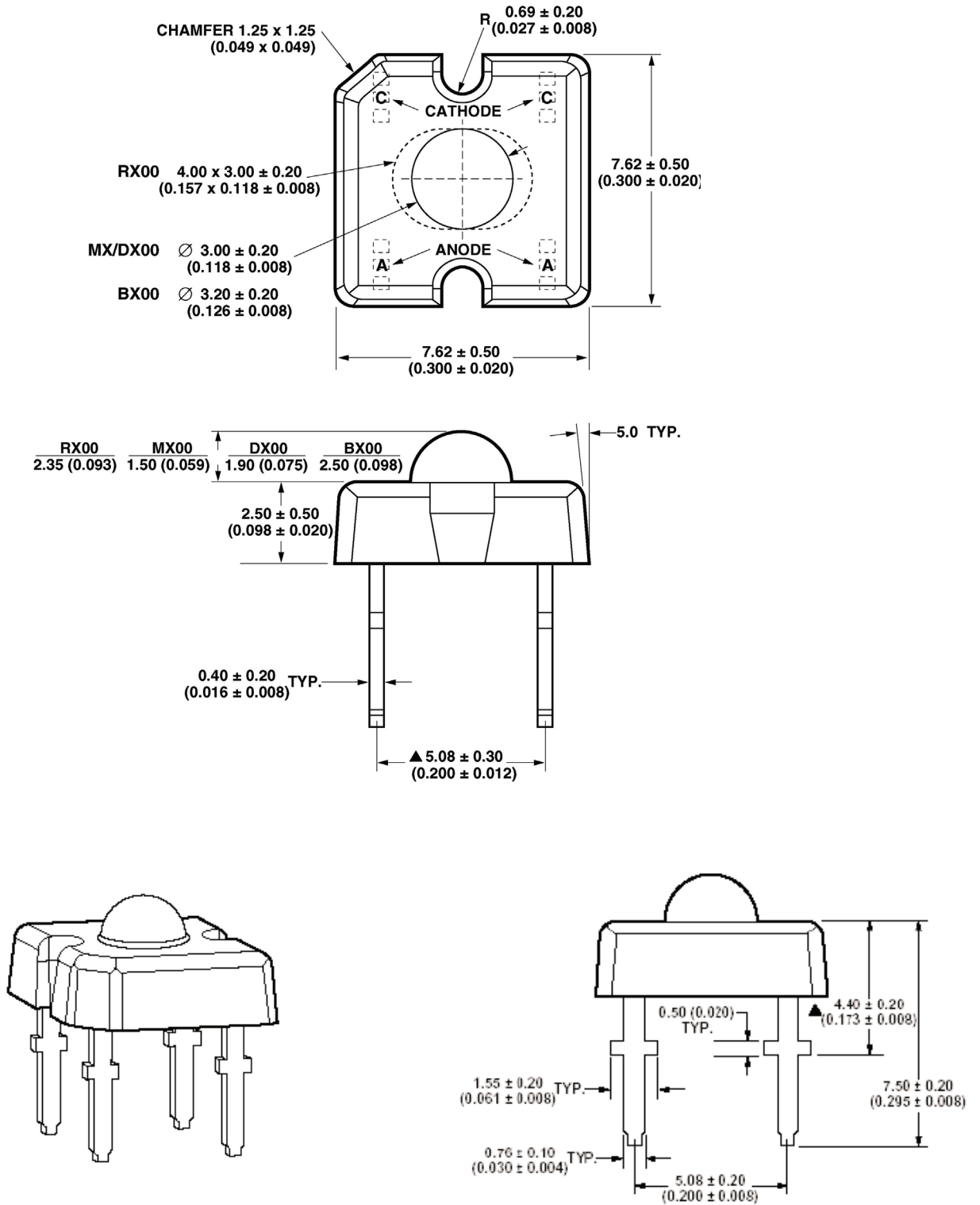

Figure 1. Package outline drawing.

Selection Guide

Table 2.

Device Type	LED Color	Total Included Angle (90V Degrees) [1] Typ.
HPWT-RD02	TS AlInGaP Red	44 × 88
HPWT-RD62		
HPWT-MD02		100
HPWT-MD62		
HPWT-DD02		70
HPWT-DD62		
HPWT-BD02	TS AlInGaP Red-Orange	50
HPWT-BD62		
HPWT-RH02		44 × 88
HPWT-RH62		
HPWT-MH02		100
HPWT-MH62		
HPWT-DH02	70	
HPWT-DH62		
HPWT-BH02	TS AlInGaP Amber	50
HPWT-BH62		
HPWT-RL02		44 × 88
HPWT-RL62		
HPWT-ML02		100
HPWT-ML62		
HPWT-DL02	70	
HPWT-DL62		
HPWT-BL02	TS AlInGaP Amber	50
HPWT-BL62		

Notes for Table 2:

1. 00.90V is the included angle at which 90% of the total luminous flux is captured.

Absolute Maximum Ratings

Table 3.

Parameter	HPWT	Units
DC Forward Current ^[1]	75	mA
Power Dissipation	221	mW
Reverse Voltage (IR = 100 mA)	10	V
Operating Temperature Range	-40 - +100	°C
Storage Temperature Range	-55 - +100	°C
High Temperature Chamber	125 °C, 2 hours	
LED Junction Temperature	125 °C	
Solder Conditions ^[2] Preheat	85 +/- 15°C, 70 sec +/- 20 sec 250 +/- 5°C, 2.5 +/- 0.5	
Temperature Solder Temperature	sec [1.5mm (0.06 in) below seating plane]	

Notes for Table 3:

1. Derate as shown in Figures 5b.
2. See “Recommended Soldering Conditions”, Page 16.

Optical Characteristics

Optical Characteristics at $T_A = 25^\circ\text{C}$, $I_F = 70\text{ mA}$, $R_{\theta\text{J-A}} = 200^\circ\text{C/W}$

Table 4.

Device Type	Peak Wavelength λ_{peak} (nm) Typ.	Dominant Wavelength λ_{dom} (nm) [1] Typ.	Total Included Angle $\theta_{0.90\text{V}}$ (Degrees) [2] Typ.	Luminous Intensity Total Flux $I_v(\text{cd})/\Phi_v(\text{lm})$	Viewing Angle (degrees) 2θ 1/2
HPWT-RD02	640	630	44 × 88	1.25	25 × 68
HPWT-RD62	640	630	44 × 88	1.25	25 × 68
HPWT-MD02	640	630	100	0.6	70
HPWT-MD62	640	630	100	0.6	70
HPWT-DD02	640	630	70	1.5	40
HPWT-DD62	640	630	70	1.5	40
HPWT-BD02	640	630	50	2	30
HPWT-BD62	640	630	50	2	30
HPWT-RH02	626	620	44 × 88	1.25	25 × 68
HPWT-RH62	626	620	44 × 88	1.25	25 × 68
HPWT-MH02	626	620	100	0.6	70
HPWT-MH62	626	620	100	0.6	70
HPWT-DH02	626	620	70	1.5	40
HPWT-DH62	626	620	70	1.5	40
HPWT-BH02	626	620	50	2	30
HPWT-BH62	626	620	50	2	30
HPWT-RL02	596	594	44 × 88	1.25	25 × 68
HPWT-RL62	596	594	44 × 88	1.25	25 × 68
HPWT-ML02	596	594	100	0.6	70
HPWT-ML62	596	594	100	0.6	70
HPWT-DL02	596	594	70	1.5	40
HPWT-DL62	596	594	70	1.5	40
HPWT-BL02	596	594	50	2	30
HPWT-BL62	596	594	50	2	30

Notes for Table 4:

1. The dominant wavelength is derived from the CIE Chromaticity Diagram and represents the perceived color of the device.
2. $\theta_{0.90\text{V}}$ is the included angle at which 90% of the total luminous flux is captured.

Electrical Characteristics

Electrical Characteristics at $T_A = 25^\circ\text{C}$

Table 5.

Device Type	Forward Voltage V_f (Volts) $I_f = 75\text{ mA}$ (HPWT)			Forward Voltage V_f (Volts) $I_f = 2.5\text{ mA}$ (HPWT)			Reverse Breakdown @ V_R (Volts) ^[1] @ $I_R = 100\ \mu\text{A}$		Capacitance C (pF) $V_f = 0$ F = 1 MHz.	Thermal Resistance $R\theta_{J-PIN}$ ($^\circ\text{C}/\text{W}$)	Speed of Response τ_s (ns) ^[2]
	Min.	Typ.	Max.	Min.	Typ.	Max.	Min.	Typ.	Typ.	Typ.	Typ.
HPWT-xD02	2.19	2.6	3.03	1.75	1.9	2.15	10	20	40	155	20
HPWT-xD62	2.19	2.6	3.03	1.75	1.9	2.15	10	20	40	155	20
HPWT-xH02	2.19	2.6	3.03	1.75	1.9	2.15	10	20	40	155	20
HPWT-xH62	2.19	2.6	3.03	1.75	1.9	2.15	10	20	40	155	20
HPWT-xL02	2.19	2.6	3.15	1.75	1.9	2.15	10	20	40	155	20
HPWT-xL62	2.19	2.6	3.15	1.75	1.9	2.15	10	20	40	155	20

Notes for Table 5:

1. Operation in reverse bias is not recommended.
2. τ_s is the time constant, et/τ_s .

Part Number Selection

Red Part Number Selection

Table 6.

Part Number	Viewing Angle $2\theta^{1/2}$ (Degrees)	Min. Flux ^[1] Φ_v (lm)	Max. Flux Φ_v (lm)	Minimum Intensity (cd)	Maximum Intensity (cd)
HPWT-RD02-00000	25 X 68	1.5		1.9	
HPWT-RD02-D4000	25 X 68	2.0	4.8	2.5	6.0
HPWT-RD02-E4000	25 X 68	2.5	6.1	3.1	7.6
HPWT-RD02-F4000	25 X 68	3.0	7.3	3.8	9.1
HPWT-BD02-00000	30	1.5		3.0	
HPWT-BD02-D4000	30	2.0	4.8	4.0	9.6
HPWT-BD02-E4000	30	2.5	6.1	5.0	12.2
HPWT-BD02-F4000	30	3.0	7.3	6.0	14.6
HPWT-DD02-00000	40	1.5		2.3	
HPWT-DD02-D4000	40	2.0	4.8	3.0	7.2
HPWT-DD02-E4000	40	2.5	6.1	3.8	9.2
HPWT-DD02-F4000	40	3.0	7.3	4.5	11.0
HPWT-MD02-00000	70	1.5		0.9	
HPWT-MD02-D4000	70	2.0	4.8	1.2	2.9
HPWT-MD02-E4000	70	2.5	6.1	1.5	3.7
HPWT-MD02-F4000	70	3.0	7.3	1.8	4.4

Note for Table 6:

1. Φ_v is the total luminous flux output as measured with an integrating sphere after the device has stabilized.

Part Number Selection, Continued

Red-Orange Part Number Selection

Table 7.

Part Number	Viewing Angle $2\theta^{1/2}$ (Degrees)	Min. Flux $\Phi_v(\text{lm})$	Max. Flux $\Phi_v(\text{lm})$	Minimum Intensity (cd)	Maximum Intensity (cd)
HPWT-RH02-00000	25 X 68	1.5		1.9	
HPWT-RH02-D4000	25 X 68	2.0	4.8	2.5	6.0
HPWT-RH02-E4000	25 X 68	2.5	6.1	3.1	7.6
HPWT-RH02-F4000	25 X 68	3.0	7.3	3.8	9.1
HPWT-RH02-G4000	25 X 68	3.5	9.7	4.4	12.1
HPWT-RH02-H4000	25 X 68	4.0	12.0	5.0	15.0
HPWT-BH02-00000	30	1.5		3.0	
HPWT-BH02-D4000	30	2.0	4.8	4.0	9.6
HPWT-BH02-E4000	30	2.5	6.1	5.0	12.2
HPWT-BH02-F4000	30	3.0	7.3	6.0	14.6
HPWT-BH62-G4000	30	3.5	9.7	7.0	19.4
HPWT-BH62-H4000	30	4.0	12.0	8.0	24.0
HPWT-DH02-00000	40	1.5		2.3	
HPWT-DH02-D4000	40	2.0	4.8	3.0	7.2
HPWT-DH02-E4000	40	2.5	6.1	3.8	9.2
HPWT-DH02-F4000	40	3.0	7.3	4.5	11.0
HPWT-DH02-G4000	40	3.5	9.7	5.3	14.6
HPWT-DH02-H4000	40	4.0	12.0	6.0	18.0
HPWT-MH02-00000	70	1.5		0.9	
HPWT-MH02-D4000	70	2.0	4.8	1.2	2.9
HPWT-MH02-E4000	70	2.5	6.1	1.5	3.7
HPWT-MH02-F4000	70	3.0	7.3	1.8	4.4
HPWT-MH02-G4000	70	3.5	9.7	2.1	5.8
HPWT-MH02-H4000	70	4.0	12.0	2.4	7.2

Part Number Selection, Continued

Amber Part Number Selection

Table 8.

Part Number	Viewing Angle $2\theta^{1/2}$ (Degrees)	Min. Flux $\Phi_v(\text{lm})$	Max. Flux $\Phi_v(\text{lm})$	Minimum Intensity (cd)	Maximum Intensity (cd)
HPWT-RL02-00000	25 X 68	1.0		1.3	
HPWT-RL02-C4000	25 X 68	1.5	4.2	1.9	5.3
HPWT-RL02-D4000	25 X 68	2.0	4.8	2.5	6.0
HPWT-BL02-00000	30	1.0		2.0	
HPWT-BL02-C4000	30	1.5	4.2	3.0	8.4
HPWT-BL02-D4000	30	2.0	4.8	4.0	9.6
HPWT-DL02-00000	40	1.0		1.5	
HPWT-DL02-C4000	40	1.5	4.2	2.3	6.3
HPWT-DL02-D4000	40	2.0	4.8	3.0	7.2
HPWT-ML02-00000	70	1.0		0.6	
HPWT-ML02-C4000	70	1.5	4.2	0.9	2.5
HPWT-ML02-D4000	70	2.0	4.8	1.2	2.9

Figures

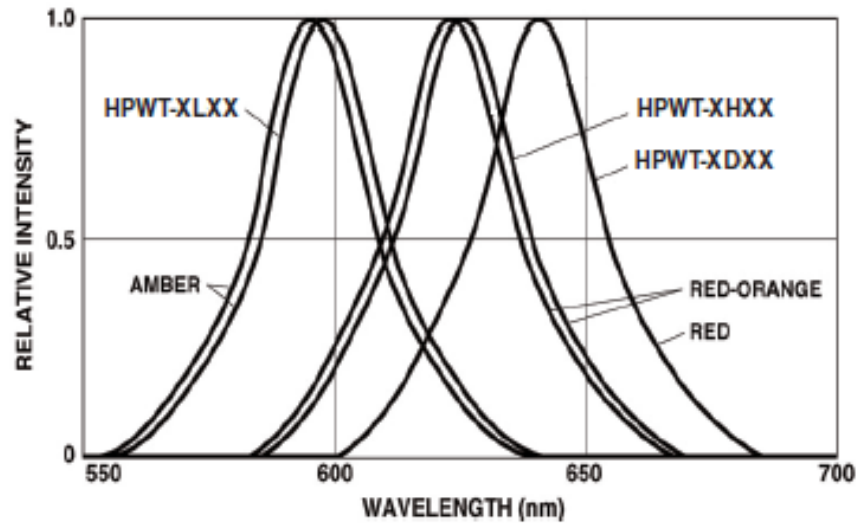

Figure 2. Relative Intensity vs. Wavelength

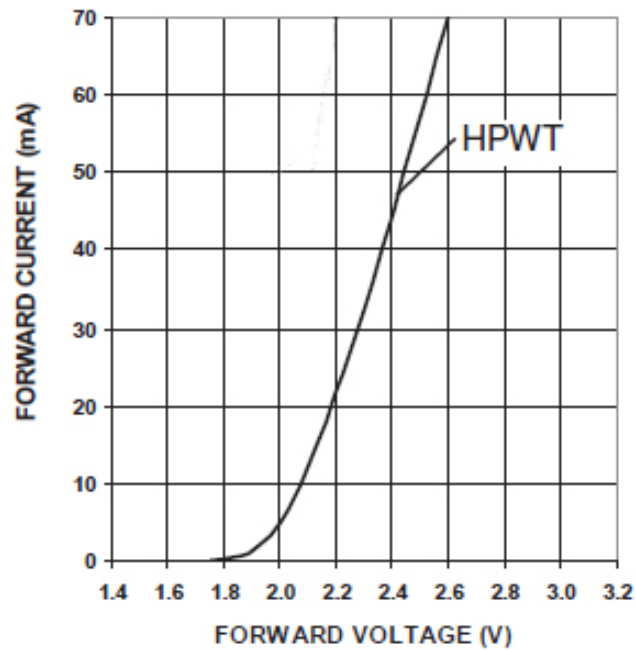

Figure 3. Forward Current vs. Forward Voltage

Figures, Continued

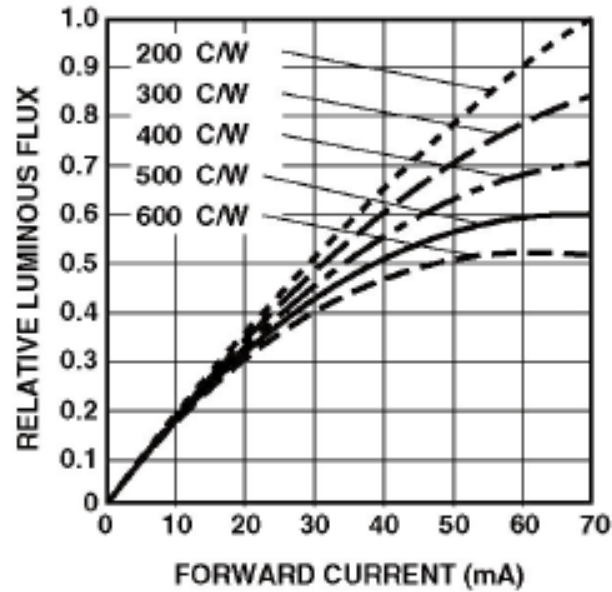

Figure 4. HPWT-xxxx Relative Luminous Flux vs. Forward Current

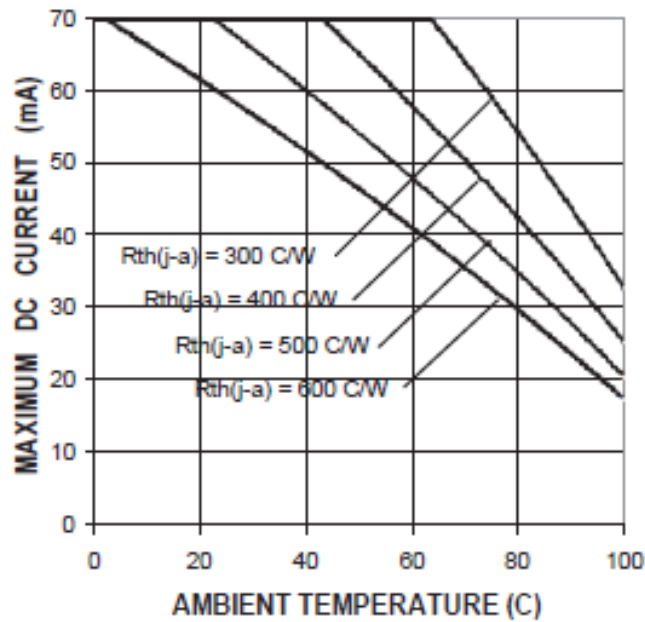

Figure 5. HPWT-xxxx Maximum DC Forward Current vs. Ambient Temperature

Note for Figure 5:

1. 24mm² of Cu pad per emitter at cathode lead is recommended for lowest thermal resistance.

Figures, Continued

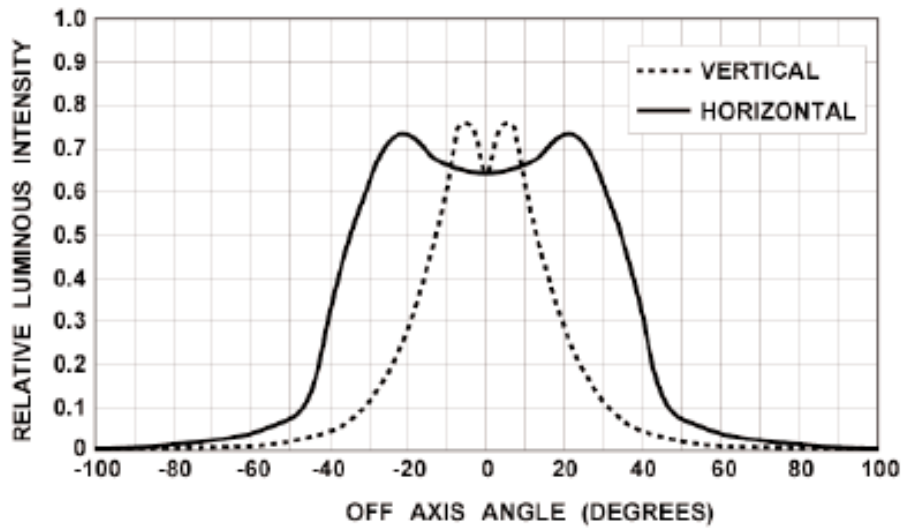

Figure 6a. HPWT-Rxxx Relative Luminous Intensity vs. Off Axis Angle

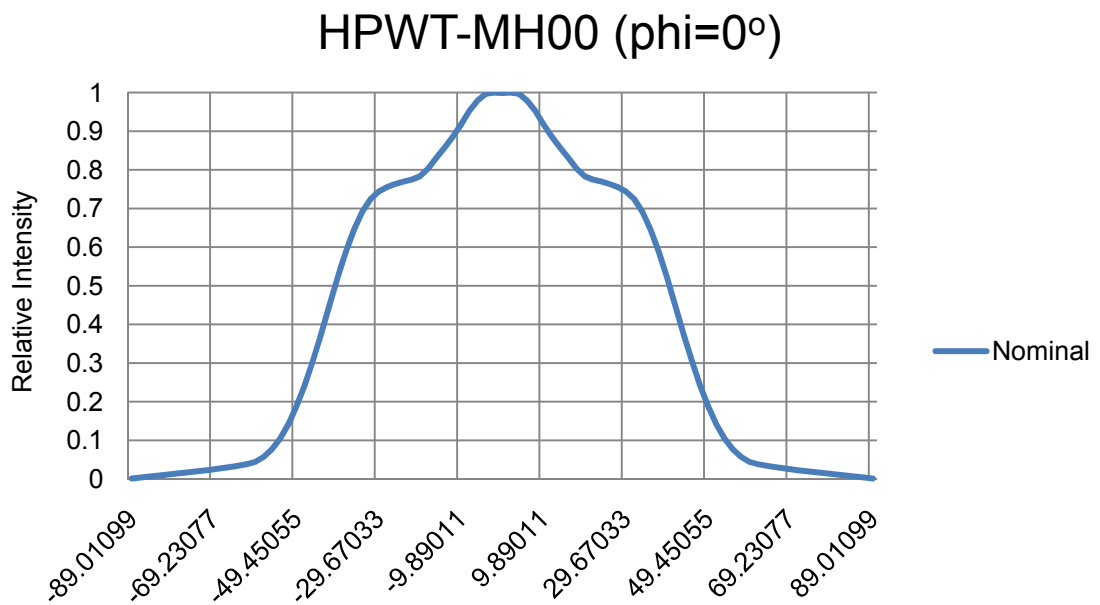

Figure 6b. HPWT-Mxxx Relative Luminous Intensity vs. Off Axis Angle

Figures, Continued

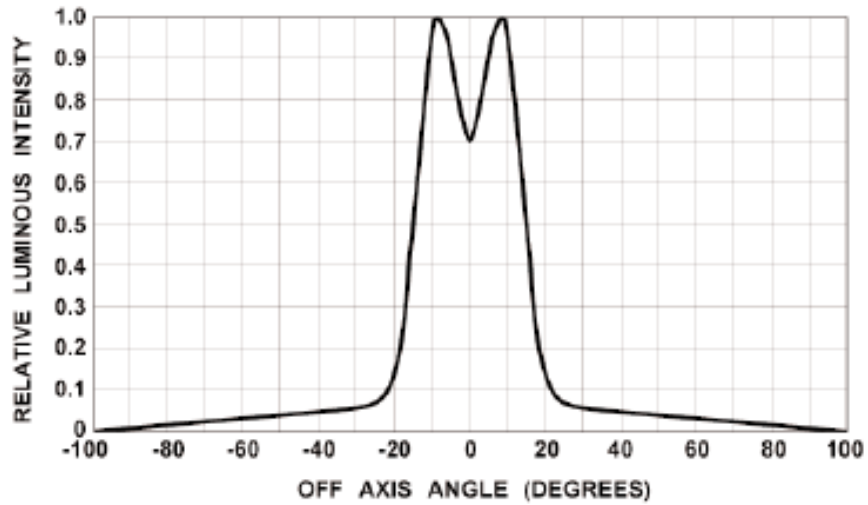

Figure 6c. HPWT-Bxxx Relative Luminous Intensity vs. Off Axis Angle

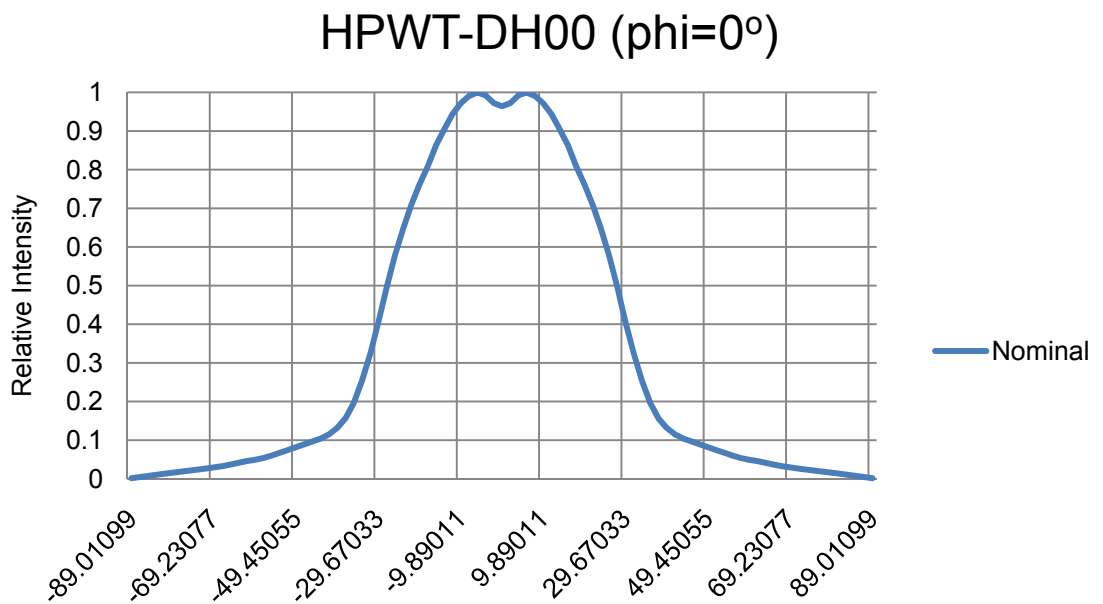

Figure 6d. HPWT-Dxxx Relative Luminous Intensity vs. Off Axis Angle

Recommended Soldering Conditions for Pb-Free SuperFlux

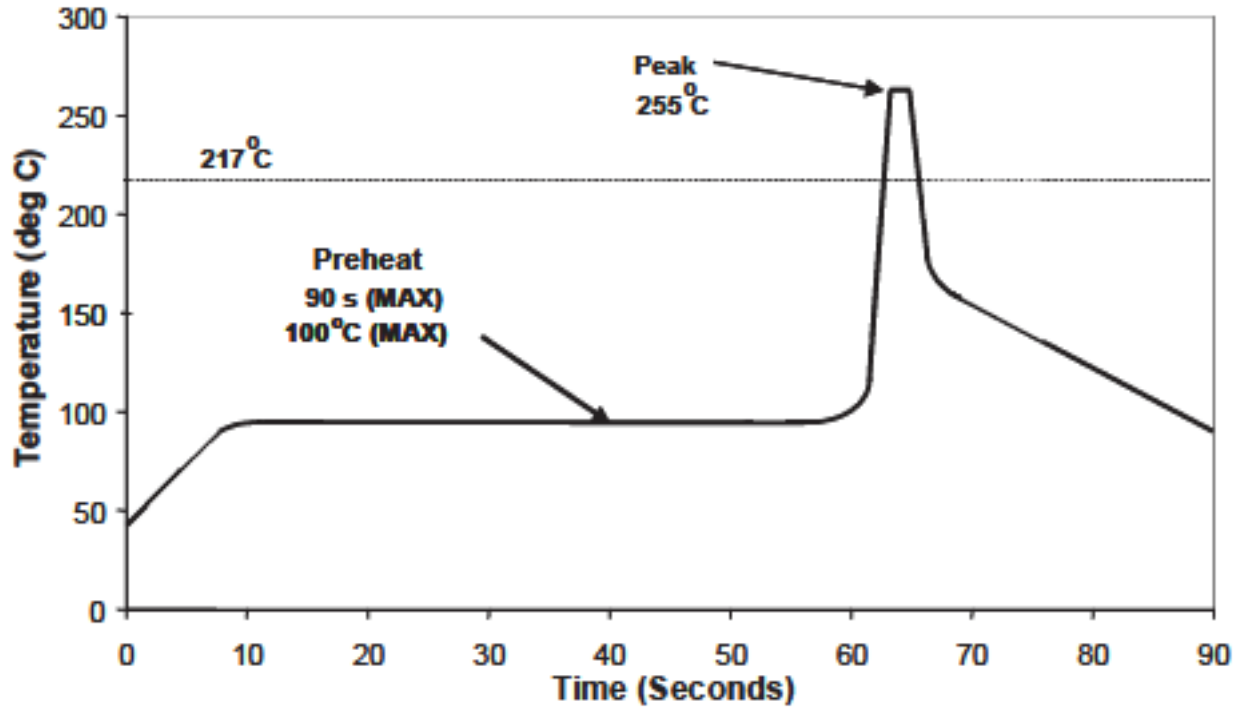

Figure 7. HPWT-Dxxx Relative Luminous Intensity vs. Off Axis Angle

Table 9. Solder Conditions

Preheat Temperature	85 +/- 15°C
Preheat Time	70s +/- 20s
Peak Profile Temperature	250 +/- 5°C
Solder Time Above 217°C	2.5 +/- 0.5s

Notes:

1. All top preheat stages are to be turned off so that the lamp body is not directly exposed to the heat source.
2. Profile taken on the LED lead at the bottom of the PCB.
3. Single wave soldering is recommended.

Company Information

Philips Lumileds is a leading provider of LEDs for everyday lighting applications. The company's records for light output, efficacy and thermal management are direct results of the ongoing commitment to advancing solid-state lighting technology and enabling lighting solutions that are more environmentally friendly, help reduce CO₂ emissions and reduce the need for power plant expansion. Philips Lumileds LUXEON® LEDs are enabling never before possible applications in outdoor lighting, shop lighting, home lighting, consumer electronics, and automotive lighting.

Philips Lumileds is a fully integrated supplier, producing core LED material in all three base colors, (Red, Green, Blue) and white. Philips Lumileds has R&D centers in San Jose, California and in the Netherlands, and production capabilities in San Jose, Singapore and Penang, Malaysia. Founded in 1999, Philips Lumileds is the high flux LED technology leader and is dedicated to bridging the gap between solid-state technology and the lighting world. More information about the company's LUXEON LED products and solid-state lighting technologies can be found at www.philipslumileds.com.

©2012 Philips Lumileds Lighting Company. All rights reserved.
Product specifications are subject to change without notice.
LUXEON is a registered trademark of the Philips Lumileds
Lighting Company in the United States and other countries.

PHILIPS
LUMILEDS

www.philipslumileds.com
www.philipslumileds.cn.com