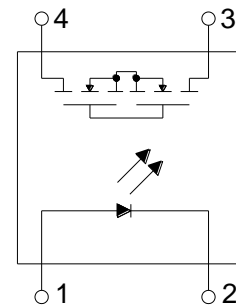


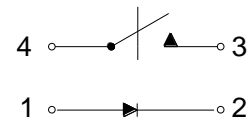
● Description

The KCP1008 series is robust, ideal for telecom and ground fault applications. It is a SPST normally open switch (1 Form A) that replaces electromechanical relays in many applications. It is constructed using a GaAlAs LED for actuation control and an integrated monolithic die for the switch output. The die is fabricated in a high-voltage dielectrically isolated technology and is comprised of a photodiode array, switch control circuitry and MOSFET switches.

● Schematic



1 FORM A
NORMALLY OPEN



● Features

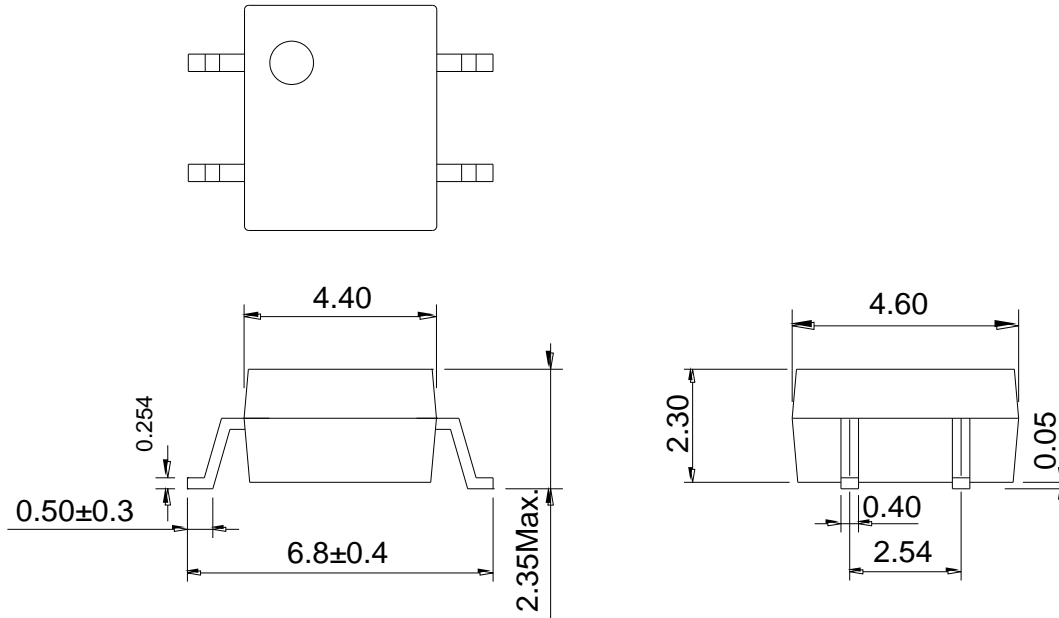
1. Normally open, single pole single throw
2. Control 100V AC or DC voltage
3. Switch 150mA loads
4. Controls low-level analog signals
5. High sensitivity, low ON resistance
6. Low-level off-state leakage current
7. High isolation voltage
8. Pb free and RoHS compliant
9. Agency Approvals :
 - UL / CUL Approved (No. E108430)
 - FIMKO Approved

● Applications

- Telecommunications (PC, electronic notepad)
- Modem
- Telephone equipment
- Security equipment
- Sensors
- Measuring and testing equipment
- Factory automation equipment
- High speed inspection machines

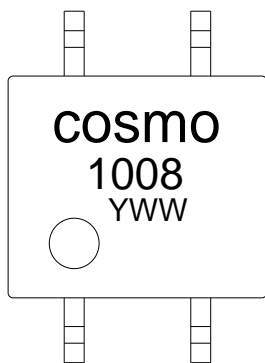
● **Outside Dimension**

Unit : mm



TOLERANCE : $\pm 0.2 \text{mm}$

● **Device Marking**



Notes :

cosmo
1008
YWW

Y : Year code / W : Week code

● Absolute Maximum Ratings

(Ta=25°C)

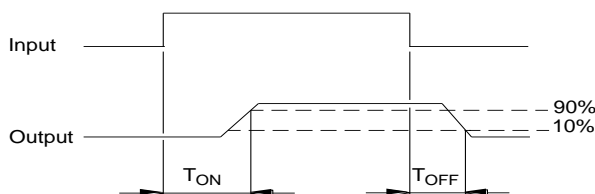
Item		Symbol	Rating	Unit
Input	Continuous forward current	I_F	50	mA
	Peak forward current	I_{FP}	1	A
	Reverse voltage	V_R	5	V
	Power dissipation	P_{in}	100	mW
	Derate linearly from 25°C	-	1.3	mW/°C
Output	Breakdown voltage	V_B	100	V
	Continuous load current	I_L	150	mA
	Power dissipation	P_{out}	500	mW
Isolation voltage		V_{iso}	1500	Vrms
Isolation resistance (Vio=500V)		R_{iso}	$\geq 10^{10}$	Ω
Total power dissipation		P_t	550	mW
Derate linearly from 25°C		-	2.5	mW/°C
Operating temperature		T_{opr}	-40 to +85	°C
Storage temperature		T_{stg}	-40 to +125	°C
Junction temperature		T_j	100	°C
Soldering temperature 10 seconds		T_{sol}	260	°C

● Electro-optical Characteristics

(Ta=25°C)

Parameter		Symbol	Conditions	Min.	Typ.	Max.	Unit
Input	Forward voltage	V_F	$I_F=10\text{mA}$	-	1.2	1.5	V
	Operation input current	I_{FON}	$V_L=20\text{V}, I_L=100\text{mA}$	-	-	2.0	mA
	Recovery input current	I_{FOFF}	$V_L=20\text{V}, I_L \leq 5\mu\text{A}$	0.2	-	-	mA
Output	Breakdown voltage	V_B	$I_B=50\mu\text{A}$	100	-	-	V
	Off-state leakage current	I_{LEAK}	$V_L=100\text{V}, I_F=0\text{mA}$	-	0.2	1.0	μA
I/O capacitance		C_{iso}	$V_B=0\text{V}, f=1\text{MHz}$	-	6	-	pF
ON resistance		R_{ON}	$I_F=10\text{mA}, I_L=100\text{mA}$	-	6	8	Ω
Turn-on time		T_{ON}	$I_F=10\text{mA}, V_L=20\text{V}$	-	0.3	2.0	ms
Turn-off time		T_{OFF}	$I_L=100\text{mA}, t=10\text{ms}$	-	0.1	1.0	ms

● Turn-on / Turn-off Time



● Schematic and Wiring Diagrams

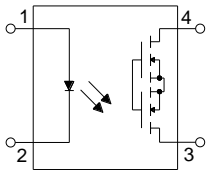
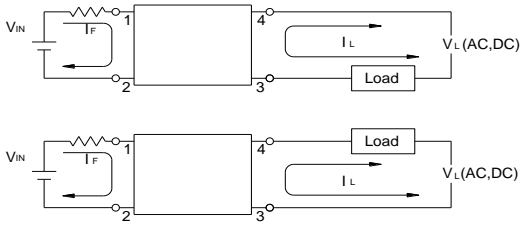
Schematic	Output Configuration	Load	Connection	Wiring Diagrams
	<p>1a</p>	<p>AC DC</p>	<p>-</p>	

Fig.1 Load Current vs. Ambient Temperature

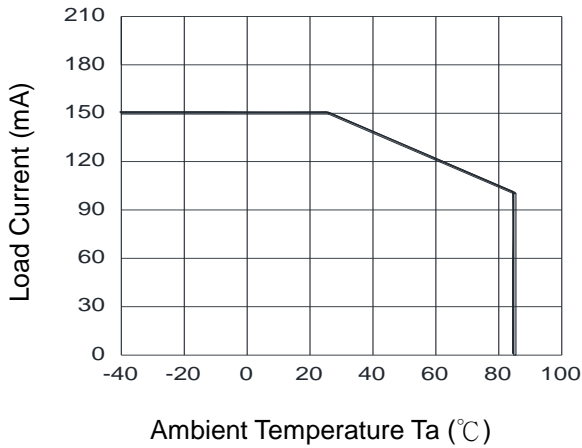


Fig.2 On Resistance vs. Ambient Temperature

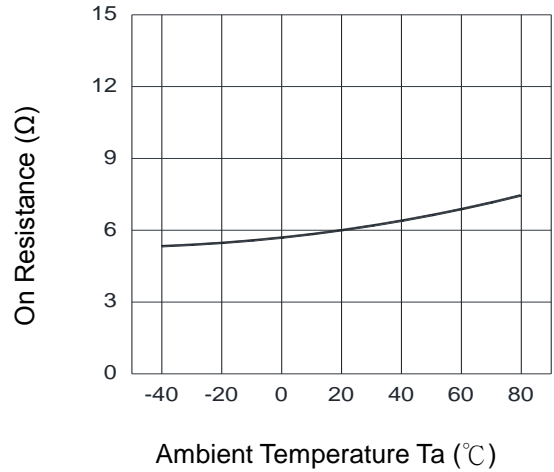


Fig.3 Turn-on Time vs. Ambient Temperature

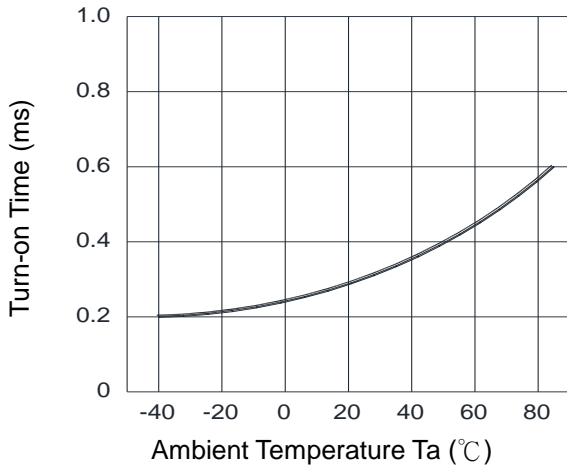


Fig.4 Turn-off Time vs. Ambient Temperature

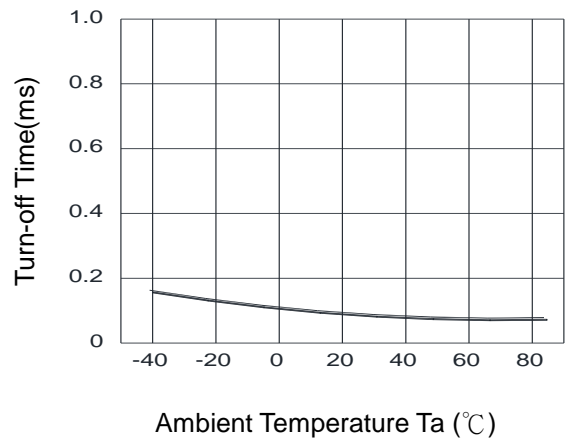


Fig.5 LED Operate Current vs. Ambient Temperature

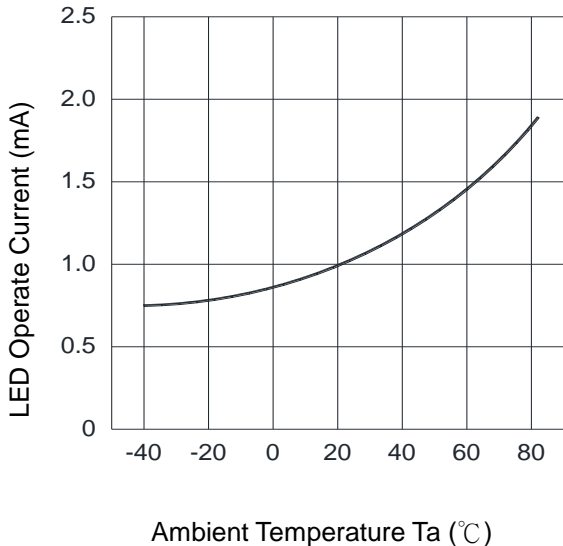


Fig.6 LED Turn-off Current vs. Ambient Temperature

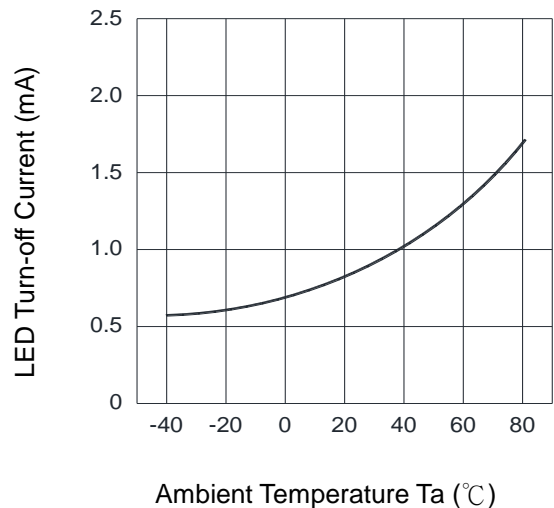


Fig.7 LED Dropout Voltage vs. Ambient Temperature

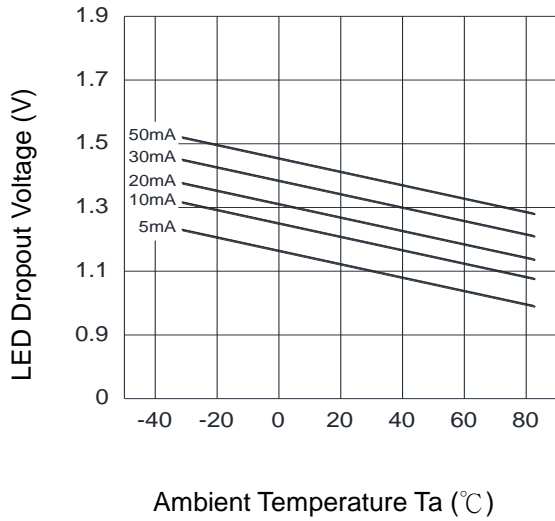


Fig.8 Voltage vs. Current Characteristics of Output at MOSFET Portion

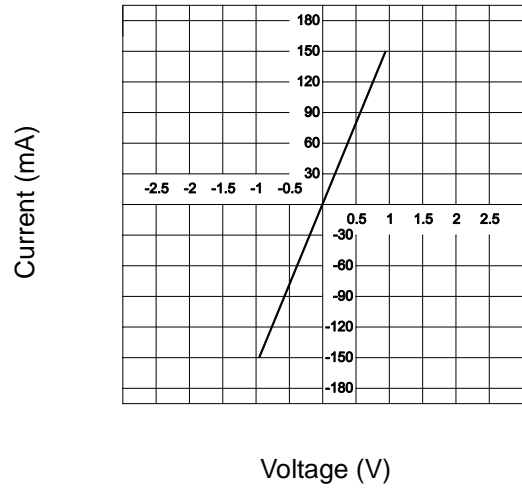


Fig.9 Turn-on Time vs. LED Forward Current

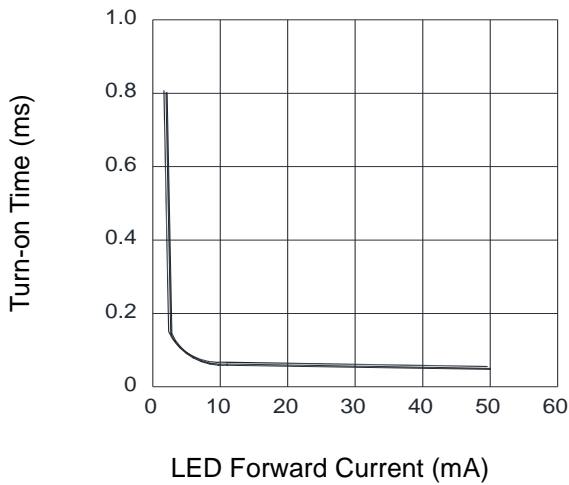


Fig.10 Off-state Leakage Current vs. Load Voltage

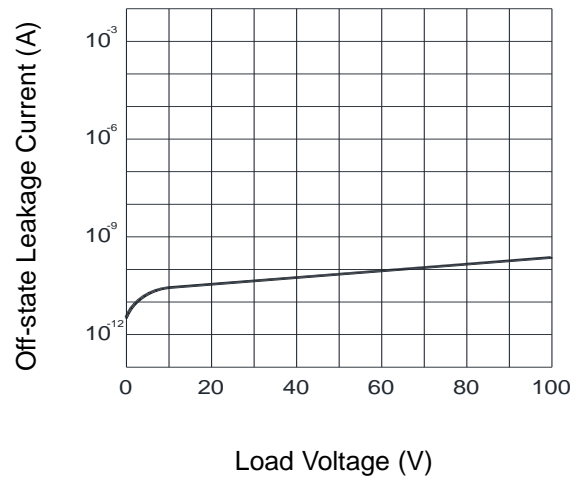


Fig.11 Turn-off Time vs. LED Forward Current

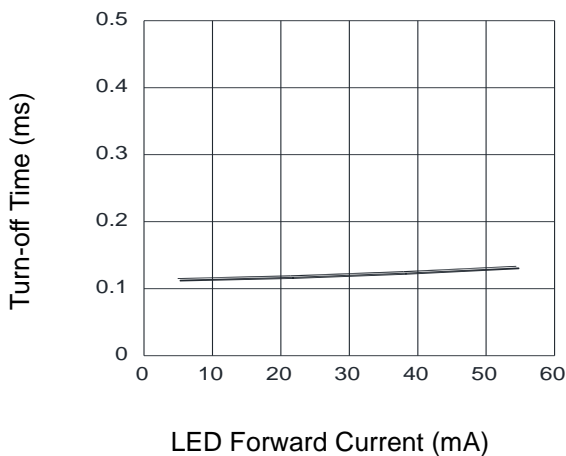
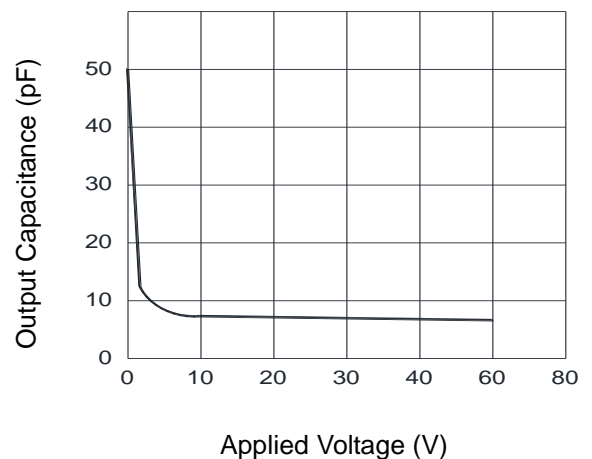
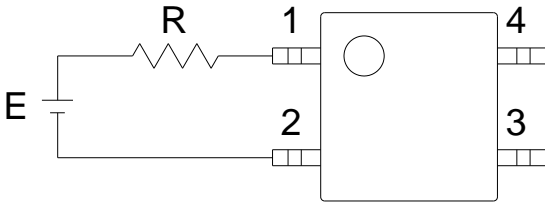


Fig.12 Output Capacitance vs. Applied Voltage



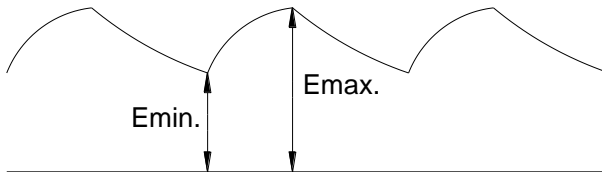
● Using Methods

Examples of resistance value to control LED forward current ($I_f=2\text{mA}$)

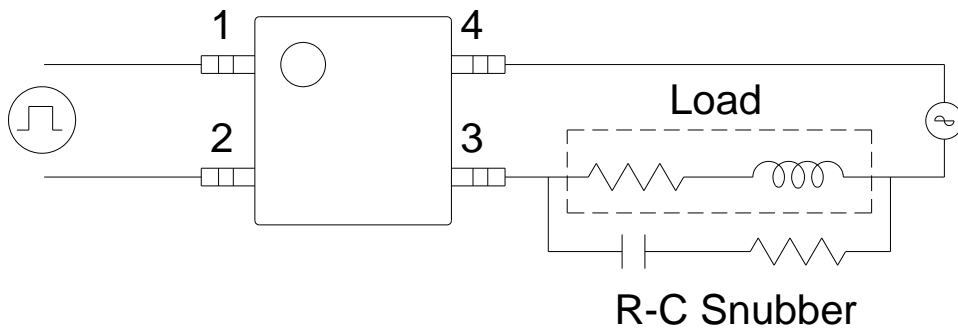
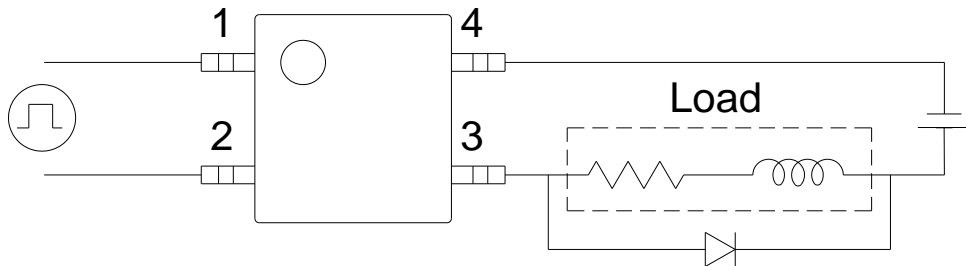


E	R
3.3V	Approx. 720 Ω
5V	Approx. 1.5K Ω
12V	Approx. 4.5K Ω
15V	Approx. 6.0K Ω
24V	Approx. 9.5K Ω

1. LED forward current must be more than 2mA , at E min.
2. LED forward current must be less than 50mA , at E max.



Regulate the spike voltage generated on the inductive load as follows :

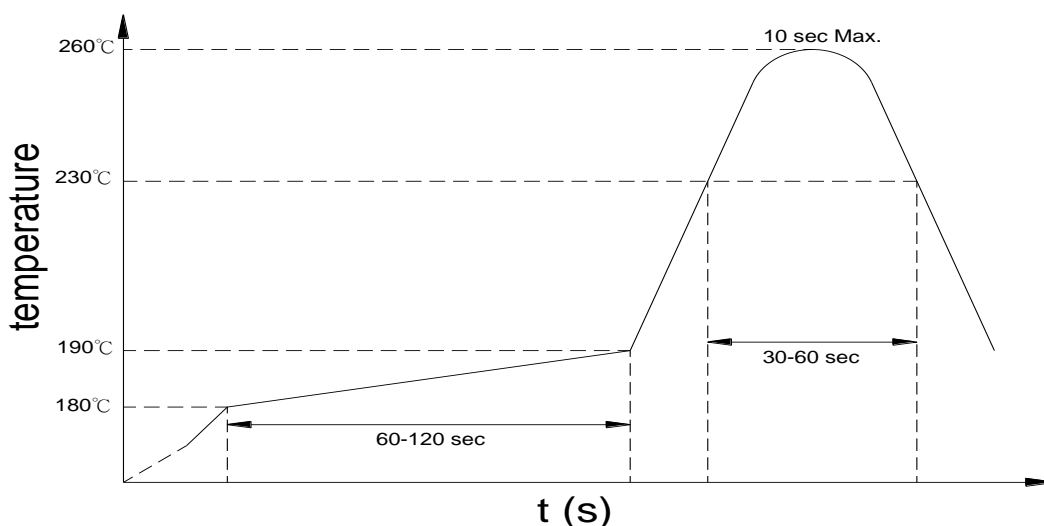


● Recommended Soldering Conditions

(a) Infrared reflow soldering :

- Peak reflow soldering : 260°C or below (package surface temperature)
- Time of peak reflow temperature : 10 sec
- Time of temperature higher than 230°C : 30-60 sec
- Time to preheat temperature from 180~190°C : 60-120 sec
- Time(s) of reflow : Two
- Flux : Rosin flux containing small amount of chlorine (The flux with a maximum chlorine content of 0.2 Wt% is recommended.)

Recommended Temperature Profile of Infrared Reflow



(b) Wave soldering :

- Temperature : 260°C or below (molten solder temperature)
- Time : 10 seconds or less
- Preheating conditions : 120°C or below (package surface temperature)
- Time(s) of reflow : One
- Flux : Rosin flux containing small amount of chlorine (The flux with a maximum chlorine content of 0.2 Wt% is recommended.)

(c) Cautions :

- Fluxes : Avoid removing the residual flux with freon-based and chlorine-based cleaning solvent.
- Avoid shorting between portion of frame and leads.

- **Numbering System**

KCP1008 (X)

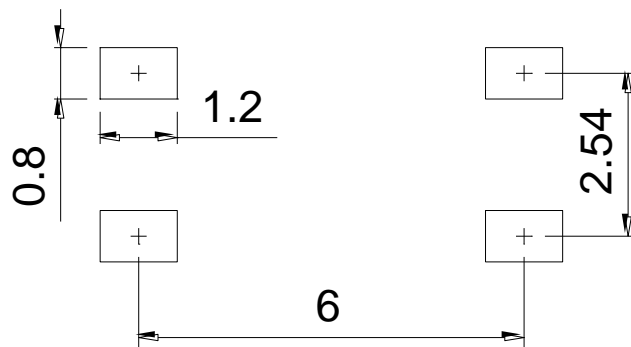
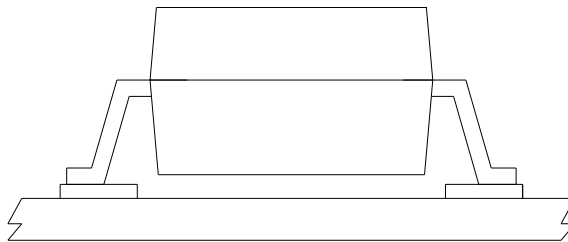
Notes :

KCP1008 = Part No.

X = Tape and reel option (TL · TR)

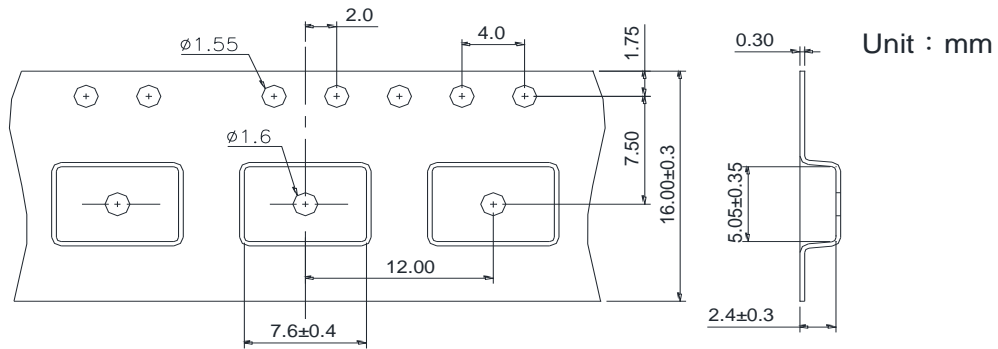
Option	Description	Packing quantity
TL	small outline for surface mount type package + TL tape & reel option	2000 units per reel
TR	small outline for surface mount type package + TR tape & reel option	2000 units per reel

- **Recommended Pad Layout for Surface Mount Lead Form**



Unit : mm

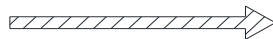
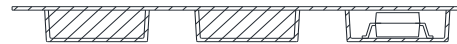
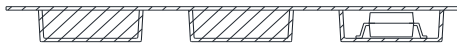
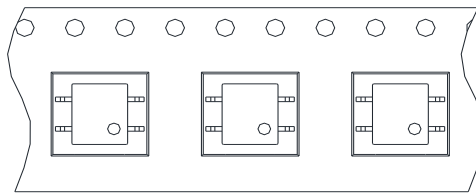
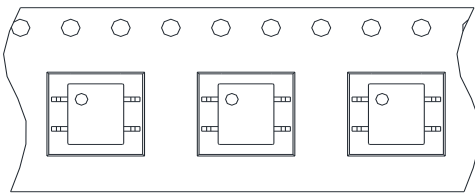
● 4-pin SOP Carrier Tape & Reel



TOLERANCE : ±0.2mm

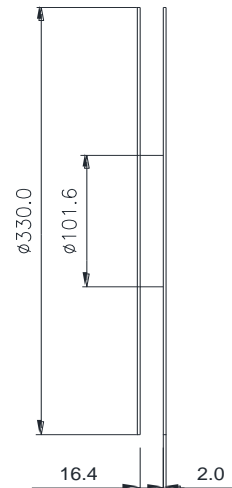
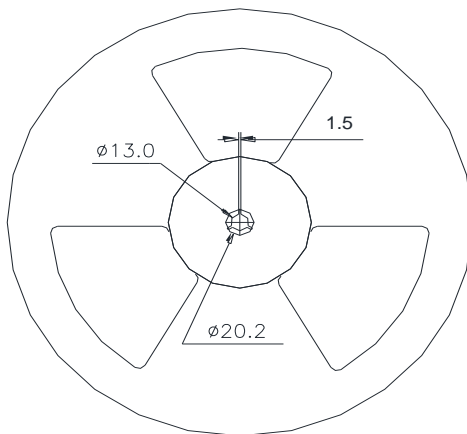
TL

TR



Direction of feed from reel

Direction of feed from reel



● Application Notice

The content of datasheet is the guidance for product use only. cosmo takes no responsibility to the accuracy of the information provided here. For continuously improving all of products, including quality, reliability, function...etc., cosmo reserves the right to change the specification, characteristics, data, materials, and structure of products without notice. Please contact with cosmo to obtain the latest specification.

It would be required to comply with the absolute maximum ratings listed in the specification. cosmo has no liability and responsibility to the damage caused by improper use of the products.

cosmo products are intended to be designed for use in general electronics application list below:

- a. Personal computer
- b. OA machine
- c. Audio / Video
- d. Instrumentation
- e. Electrical application
- f. Measurement equipment
- g. Consumer electronics
- h. Telecommunication

cosmo devices shall not be used or related with equipment requiring higher level of quality / reliability, or malfunction, or failure which may cause loss of human life, bodily injury, includes, without limitation:

- a. Medical and other life supporting equipments
- b. Space application
- c. Telecommunication equipment (trunk lines)
- d. Nuclear power control
- e. Equipment used for automotive vehicles, trains, ships...etc.

This publication is the property of cosmo. No part of this publication may be reproduced or copied in any form or any means electronically or mechanically for any purpose, in whole or in part without any written permission expressed from cosmo.