



ELECTRICAL INDUSTRIES



2011 general catalogue 2012



FPB Palazzoli

LEWDENS COMMITMENT TO YOU	2
QUALITY	3
SPECIFICATIONS & VOLTAGE IDENTIFICATION	4
TECHNICAL CLOCKING DETAIL	5
IP CLASSIFICATION	6
IK AND CHEMICALS RESISTANCE	7





INDUSTRIAL PLUGS & SOCKETS 8

	Quick Selection Table	9
	Multimax Rapid Wiring	14
	Plugs & Connectors	16
	Surface, Panel Sockets & Inlets	19
	Splitters	31
	Low Voltage	33
	7 Pin	36
	High Frequency	39
	Metal	41
	High Current	42

SWITCHED INTERLOCKED SOCKETS 44

	Moulded Switch Sockets	46
	Moulded Interlocked Switched Sockets	48
	Thermosetting GRP Interlocked Switched Sockets	50
	Aluminium Switched Interlocked Sockets	51

RCD UNITS 52

	Moulded RCD Sockets	53
	Moulded RCD Switched Interlocked Sockets	54
	Thermosetting GRP RCD Switched Interlocked Sockets	55
	Metal Clad RCD Switched Interlocked Sockets	55

REEFER CONTAINER

56



Plugs & Connectors 57



Surface, Panel Sockets & Inlets 58



Switched & Interlocked Sockets 59

NORTH AMERICAN RANGE

60



Plugs & Connectors 62



Extended Range 63

topTER SERIES - THE MODULAR SYSTEM

64

Modular system combinations 67



16A & 32A interlocked socket outlets 68



16A & 32A boxes & boards 70



63A interlocked socket outlets 72



63A boxes & boards 73



16A & 32A fixed socket outlets 74



16A & 32A boxes & boards 75



Additional accessories 76

WEATHERTIGHT METAL CLAD RANGE

82

Template of gauges 84



13A plugs 85



13A sockets & switched sockets 86



Round pin plugs & sockets 87



Round pin switch sockets 88



Mighty Seal 89



Switches 90



Bell push 91



Marshalling box 91

ISOLATORS & SWITCHES

92



Moulded isolator switches 94



Isolator switches 96



Fused switches 97

CARAVAN & MARINE

98



Hook up units 100



Mounting Stake 101



Stainless steel turrets B-Smart 102



Accessories 105

ENCLOSURES

106



G.R.P. The enclosure system - Tais Tre 108



Enclosures, junction boxes & consumer units 112



Metal enclosures & control units Alupres 115



Compact series accessories 117



GRP Enclosures 120



Steel Enclosures 120



Stainless Steel Enclosures 122



Rubber Enclosures 123



Rubber Combi Bloks 125

CABLE & CONDUIT FITTINGS

126



Die cast accessories 127



Brass Armoured cable glands 129

Cable gland capacity table 130

Selector table 131

MAESTRO PLUG IN CEILING ROSE

132



CUSTOM BUILD

134



LEWDENS COMMITMENT TO YOU...

You can be assured that at Lewden Electrical Industries we will do our utmost to:

- Support your enquiry through our Customer Service team to help with your product selection and deliver on time
- Provide a single source supply line for your requirements from our wide range of related products
- Supply products to the highest quality level, applying Quality Systems Management in accordance with ISO 9001, independently audited
- Supply products that have been manufactured from assessed facilities, the products appropriately tested against relevant standards and third party certified where required
- Provide our customers with good technical “back up” and offer a “custom made” service for those occasions where standard products do not meet the needs
- Keep our stock holding at a level to confidently provide “the best service” to our customers
- Continue to invest in improving our service and support, and welcome feed back from our customers

OUR GUARANTEE TO YOU...

“ we aim to be the best in quality and service”

OUR QUALITY COMMITMENT.....

Lewden Electrical Industries is fully committed to Quality and is compliant with the requirements of the latest Quality Management System to BS EN ISO 9001: 2008 for which we have been awarded the certificate and registered FS 37316 by our auditor British Standards Institute (BSI).

Our compliance covers design, development, manufacturing, testing sales and distribution; demonstrating our commitment to excellence.

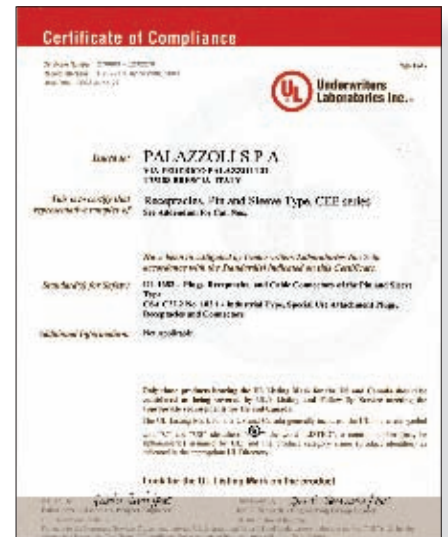

Austria



Belgium



Czech Republic
Slovakia



Denmark



Finland



France



Germany



Great Britain



Hungary



Italy



Netherlands



Norway



Spain



Poland



Sweden



Switzerland

SPECIFICATIONS

Plug pins and sockets are manufactured from solid brass.

External screws and springs are corrosion resistant.

Plugs, connectors and socket bodies within this section are manufactured from high impact, self extinguishing, durable and stable engineering plastics.

All Lewden materials are tested and approved to exceed their required glow-wire requirements for their current carrying and non-current carrying elements of each product shown in this section of the catalogue.

All Lewden materials are resistant to chemical reaction, including hydro-chemicals, mineral oils, alcohols, acids, petrol, saline (salt water) etc that we have come across.

Lewden products are suitable for use in extremes of temperature from -25°C to +50°C.

Lewden 63A and 125A plugs and sockets are fitted with a pilot contact for use in electrical interlocking circuits.

Lewden switched interlocked sockets prevent initiation of power unless the correct mating plug is fully inserted. Once inserted, the plug cannot be withdrawn until the socket is de-energised.

VOLTAGE IDENTIFICATION

COMPLIANCE WITH STANDARDS

- Lewden products, as applicable, are compliant in meeting IEC 60309-2 and its European equivalents EN 60309-2, CEI EN 60309-2 and BS EN 60309-2. This means that products manufactured to the same specification are fully compatible.

VOLTAGE IDENTIFICATION

- Lewden IEC 60309-2 products are colour coded so that the voltage at which they operate is easily identified. The diagram adjacent shows the colour codes applicable to each voltage bond.

SAFETY AND CLOCK POSITION IN IEC 60309-2 PRODUCTS

- The IEC 60309-2 Standard and its system, ensures that only the correct plug can only be inserted in its mating socket. For each of the current ratings (amperes), the plugs are different in diameter, the pins are different in size and the separation between pins is varied. The plug is matched to its socket by the combination of a key to keyway and an Earth pin; which is larger in diameter than other pins; to align and insert into the Earth Contact Tube. The clock position of the Earth to the Key is different for each voltage in plugs and sockets of same amperage.

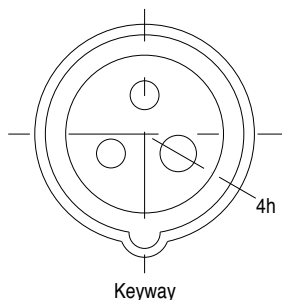

EXAMPLE: 16A - 110V SOCKET – 3 PIN SOCKET

- Larger diameter representing the Earth tube.
- Imagine as clock face
- Key is at 6 o'clock
- Earth tube is at 4 o'clock
- Diameter size relevant to Amps

Note- Low Voltage plug and sockets use a different system to achieve the same degree of Protection, in achieving non-interchange ability.

CLOCKING DETAIL

Earth "clock" position on over 50V equipment

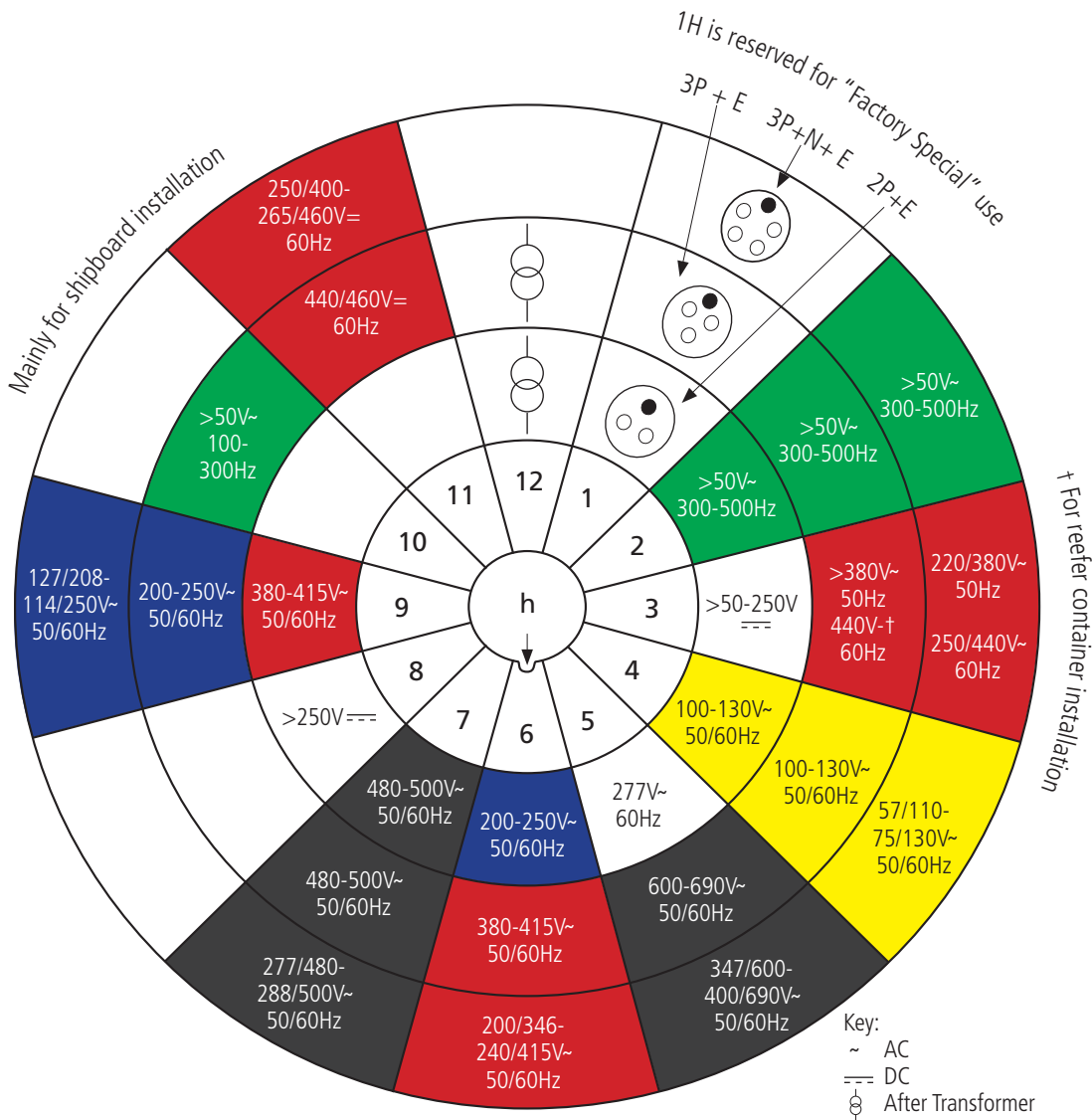

Minor keyway position in relation to the major keyway (at 6H) on low voltage (less than 50V) equipment (as viewed from the front of the socket).

No of Poles	Frequency Hz	Voltage	Minor keyway Position
2 or 3	50/60	20-25	None
2 or 3	50/60	40-50	12h
2 or 3	100-200	40-50	4h
2 or 3	300	20-25 40-50	2h
2 or 3	400	20-25 40-50	3h
2 or 3	>400-500	20-25 40-50	11h
2 or 3	Direct Current	< 50	10h

IP CLASSIFICATION

ENCLOSURE INGRESS PROTECTION RATING - IP PROTECTION RATING

IP protection rating is the code system used to indicate the levels of protection of casings against the ingress of hazardous parts or the penetration of solid foreign bodies, and/or water ingress.

According to the installation environment, the level of pollution (presence of dust, metal or non-metal particles, humidity etc) or the presence of water, an electric device protected by enclosure may encounter penetration of solid bodies and/or water inside the enclosure and this can come into contact with live parts, generating hazards and/or undesired phenomena such as ground current, tracking, electrical arcing, short circuits etc.

For this reason Product Standards foresee the verification of the IP protection rating (in some cases the minimum threshold is also stated) and the Plant Regulations require the minimum IP protection rating according to the installation environment.

Furthermore, the IP protection rating allows the implementation of protection for persons against direct contact.

IP CODE STRUCTURE

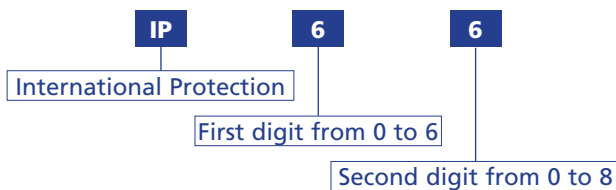

FIRST FIGURE: protection against the ingress of hazardous parts and the penetration of solid foreign bodies

IP 0X	IP 1X	IP 2X	IP 3X	IP 4X	IP 5X	IP 6X
No protection	Protection against access to dangerous parts by the back of the hand. Protection against solid foreign objects with a diameter of 50 mm.	Protection against access to dangerous parts by fingers.	Protection against access to dangerous parts with tools (e.g. screwdriver).	Protection against solid foreign objects with a diameter of 2.5 mm. Protection against access to dangerous parts with a wire.	Protection against solid foreign objects with a diameter of 1 mm. Protection against the damaging penetration of dusts.	Complete protection against dust. (dust cannot penetrate.)

SECOND FIGURE: protection against the ingress of water

Up to the second characteristic figure 6 included, the higher figure includes also the conformity to the lower one.

IP X0	IP X1	IP X2	IP X3	IP X4	IP X5	IP X6	IP X7	IP X8
No protection	Protection against vertical falling drops of water.	Protection against vertically falling drops of water with an enclosure angled up to 15°.	Protection against rain. (at up to 60° difference to the vertical).	Protection against splashed water (from all directions).	Protection against jets of water (from all directions).	Protection against powerful jets of water (from all directions).	Protection from damage by temporary immersion.	Protection from damage by continuous immersion, in conditions agreed between the manufacturer and the user.

IEC 60309 TECHNICAL SPECIFICATIONS

IK AND CHEMICAL RESISTANCE

TEST REFERRED TO IN THE CATALOGUE

Second digit higher than 7 (included):

...“Enclosures designated with a 7 or 8 as the second figure is deemed not suitable for exposure to water jets (designated with a 5 or 6 as the second figure) and does not require compliance with 5 or 6 grade requirements unless it has been assigned a double code as follows:

Jets of water second characteristic figure	Temporary or continual immersion second characteristic figure	Designation and marking	Applications
5	7	IPX5/IPX7	Double
6	7	IPX6/IPX7	Double
5	8	IPX5/IPX8	Double
6	8	IPX6/IPX8	Double
-	7	IPX7	Simple
-	8	IPX8	Simple

The enclosures indicated for double applications seen in the last column, must meet the requirements for water jets and temporary or continual immersion.

The enclosures indicated for simple applications seen in the last column, are only suitable for temporary or continual immersion and are not suitable for water jets.

ENCLOSURE PROTECTION RATING AGAINST MECHANICAL DAMAGE - IK RATING (EN 50102 STANDARD)

IK CODE STRUCTURE

Code IK	IK00	IK01	IK02	IK03	IK04	IK05	IK06	IK07	IK08	IK09	IK10
Impact force in Joules	*)	0,15	0,2	0,35	0,5	0,7	1	2	5	10	20
*) No protection											

CHEMICAL RESISTANCE

The chemical resistance of insulating materials depends on a number of factors, specifically: type of chemical agent, concentration, exposure time, temperature, product manufacturing process and any internal voltage or external mechanical actions. This means that it is too difficult to summarize, in a quick reference table, the properties of a certain product that has been subjected to the action of one or more chemical agents, in many different conditions of installation and use. The table given below can therefore be used as a guideline for initially assessing the suitability of use of Palazzoli equipment and enclosures in environments where certain chemical agents may be present. The data below refers to average operating temperatures of max. 35°C over 24 hours and max. temperatures of 40°C. YOU ARE STRONGLY ADVISED TO CONTACT LEWDEN when installing equipment in environments with the constant presence of chemical agents, especially if in a high concentration or in temperatures above those indicated. N.B. The operating temperature is often much higher than the ambient temperature, as electrical equipment heats up during normal operation.

RESISTANCE TO CHEMICAL AND ATMOSPHERIC AGENTS

	Water	Saline atmosphere	UV Rays	Sulphuric acid 23%	Chloride acid 23%	Acetic acid 23%	Hexane	Benzyl	Gasoline	Acetone	Ammonia	Dichloromethane	Diesel oil	Mineral grease and oils	Food-grade grease and oils	Perchloroethylene	Trichloroethylene	Ethylene	Toluol	Methanol/ethylic alcohol	Wine	Fruit juices	Washing digesters	Detergents
Thermoplastic																								
high resistance				•	•	•								•										
limited resistance	•	•	•				•	•	•	•		•	•	•	•	•	•	•	•	•	•	•	•	•
Thermosetting (GRP)																								
high resistance	•	•	•	•	•	•	•		•		•		•	•	•			•	•	•	•	•	•	•
limited resistance								•		•		•				•	•							
Aluminium																								
high resistance	•	•	•	•	•	•	•	•	•	•	•	•	•	•	•	•	•	•	•	•	•	•	•	•
limited resistance																								

INDUSTRIAL PLUGS & SOCKETS



INDUSTRIAL PLUGS & SOCKETS











A Comprehensive range of Industrial Plugs, Sockets & accessories to suit all environments & applications manufactured to the highest quality & meeting IEC60309 (BS EN 60309) specifications.

- Surface, flush & cable mounting
- Interchangeable with other manufacturers products meeting IEC 60309
- Range from 16amps to 125amps
- Operating voltage up to 690V ac in varying pin configurations
- Corrosion & impact resistant
- IP rated – sealed against levels of dust & water ingress
- Colour coded to identify operating voltage
- Typical operating temperature -25°C to 50°C
- Safe & reliable
- Protection against indirect contact

INDUSTRIAL PLUGS & SOCKETS

INDUSTRIAL PLUGS AND CONNECTORS MOULDED IEC 60309











RAPID SELECTION TABLE

Rated Current (A)	Frequency (Hz)	Rated Voltage (V)	No. Poles	h ref	Plugs							Connectors			
															
					IP44 Splashproof Multimax straight	IP67 Watertight Multimax straight	IP44 Splashproof Cee Series straight	IP44 Splashproof Cee Series angled	IP67 Watertight Cee Series angled	IP67 Watertight Cee Series straight	IP67 Watertight straight	IP44 Splashproof Multimax straight	IP67 Watertight Multimax straight	IP67 Watertight Cee Series straight	IP67 Watertight straight
16	50-60	110 100+130	2P+E	4	PM16/1000FPB	710124	PM16/500FPB	475202	475203	477203		PM16/2000FPB	730124	473203	
			3P+E		700134		477212	475212	475213	477213	720134		473213		
			3P+N+E		700144		477222	475222	475223	477223	720144		473223		
		230 200+250	2P+E	9	PM16/1100FPB	710126	PM16/501FPB	475302	475303	477303		PM16/2100FPB	730126	473303	
			3P+E		700139		477312	475312	475313	477313	720139		473313		
			3P+N+E		700149		477322	475322	475323	477323	720149		473323		
		400 380+415	2P+E	6	PM16/1500FPB	710136	PM16/505FPB	475412	475413	477413		PM16/2500FPB	730136	473413	
			3P+E		PM16/1800FPB	710146	PM16/508FPB	475422	475423	477423	PM16/2800FPB	730146	473423		
			3P+N+E												
		500 480+500	2P+E	7						477273				473503	
			3P+E							477513				473513	
			3P+N+E							477523				473523	
32	50-60	110 100+130	2P+E	4	PM32/1000FPB	710224	PM32/500FPB			477206		PM32/2000FPB	730224	473206	
			3P+E		700234		477215			477216	720234		473216		
			3P+N+E		700244		477225			477226	720244		473226		
		230 200+250	2P+E	9	PM32/1100FPB	710226	PM32/501FPB			477306		PM32/2100FPB	730226	473206	
			3P+E		700239		477315			477316	720239		473216		
			3P+N+E		700249		477325			477326	720249		473226		
		400 380+415	2P+E	6	PM32/1500FPB	710236	PM32/505FPB			477416		PM32/2500FPB	730236	473316	
			3P+E		PM32/1800FPB	710246	PM32/508FPB			477426	PM32/2800FPB	730246	473326		
			3P+N+E												
		500 480+500	2P+E	7						477556				473506	
			3P+E							477516				473516	
			3P+N+E							477526				473526	
63	50-60	110 100+130	2P+E	4						477207				473207	
			3P+E							477217				473217	
			3P+N+E							477227				473227	
		230 200+250	2P+E	9						477307	PM63/601			473307	PM63/801
			3P+E							477317				473317	
			3P+N+E							477327				473327	
		400 380+415	2P+E	6						477407				473407	
			3P+E							477417	PM63/605			346338	PM63/805
			3P+N+E							477427	PM63/608			356338	PM63/808
		500 480+500	3P+E	7						477517				346350	
			3P+N+E												PM125/800
125	50-60	110 100+130	2P+E	4							PM125/600				
			3P+E							477218			473218		
			3P+N+E							477228			473228		
		230 200+250	2P+E	9							PM125/601				PM125/801
			3P+E							477318			473318		
			3P+N+E							477328			477328		
		400 380+415	3P+E	6						249538	PM125/605			349538	PM125/805
			3P+N+E							259538	PM125/608			359538	PM125/808
			3P+E							249550				349550	
		500 480+500	3P+N+E	11						477538					

INDUSTRIAL PLUGS & SOCKETS

INDUSTRIAL WALL MOUNTING INLETS AND SOCKETS MOULDED IEC 60309









RAPID SELECTION TABLE

Rated Current (A)	Frequency (Hz)	Rated Voltage (V)	No. Poles	h ref	Inlets			Sockets							
															
					IP44 Splashproof angled Page 19	IP67 Watertight angled Page 20	IP67 Watertight Cee Series angled Page 20	IP44 Splashproof angled Page 21	IP44 Splashproof topTER angled Page 22	IP44 Splashproof Heavy Duty angled Page 21	IP44 Splashproof Ter Series angled Page 24	IP67 Watertight topTER angled Page 22	IP67 Watertight Ter Series angled Page 24	IP67 Watertight angled Page 23	IP67 Watertight Cee Series angled Page 23
16	50-60	110 100+130	2P+E	4	PM16/780	PM16/740		PM16/540N	508124	471262	485124	509124	487124		
			3P+E							471272	485134		487134	489134	
			3P+N+E							471222	485144		487144	489144	
		230 200+250	2P+E	6	PM16/781	PM16/741		PM16/541N	508126	471362	485126	509126	487126		
			3P+E							471372	485139		487139	489139	
			3P+N+E							471322	485149		487149	489149	
		400 380+415	2P+E	9						471462	485129		487129	489129	
			3P+E		PM16/785	PM16/745		PM16/545	508136	471472	485136	509136	487136		
			3P+N+E		PM16/788	PM16/748		PM16/548	508146	471482	485146	509146	487146		
		500 480+500	2P+E	7						471552					
			3P+E							471572					
			3P+N+E							471562					
32	50-60	110 100+130	2P+E	4	PM32/780	PM32/740		PM32/540	508224	471266	485224	509224	487224		
			3P+E							471276	485234		487234	489234	
			3P+N+E							471286	485244		487244	489244	
		230 200+250	2P+E	6	PM32/781	PM32/741		PM32/541	508226	471366	485226	509226	487226		
			3P+E							471376	485239		487239	489239	
			3P+N+E							471386	485249		487249	489249	
		400 380+415	2P+E	9						471466	485229		487229	489229	
			3P+E		PM32/785	PM32/745		PM32/545	508236	471476	485236	509236	487236		
			3P+N+E		PM32/788	PM32/748		PM32/548	508246	471486	485246	509246	487246		
		500 480+500	2P+E	7						471555					
			3P+E							471576					
			3P+N+E							471576					
63	50-60	230 200+250	2P+E	6		PM63/741	PM63/741N						PM63/641		
			3P+E												
		400 380+415	2P+E	9											
			3P+E			PM63/745N	745338						PM63/645	445338	
		3P+N+E	6		PM63/748N	748538							PM63/648	455338	
125	50-60	110 100+130	2P+E	4										PM125/640	
			3P+E											PM125/643	
			3P+N+E											PM125/646	
		230 200+250	2P+E	6			PM125/741N								PM125/641
			3P+E												PM125/644
			3P+N+E												PM125/647
		400 380+415	2P+E	9											PM125/642
			3P+E					448538						PM125/645	448538
			3P+N+E				PM125/748FPB							PM125/648	458538

INDUSTRIAL PLUGS & SOCKETS

INDUSTRIAL PANEL APPLIANCE MOULDED IEC 60309

RAPID SELECTION TABLE

Rated Current (A)	Frequency (Hz)	Rated Voltage (V)	No. Poles	h ref	Inlets			Sockets					
													
					IP44 Page 25	IP67 Page 26	IP67 Page 26	IP44 Page 27	IP44 Page 28	IP67 Page 27	IP67 Page 28	IP67 Page 28	IP67 Page 28
					IP44 Splashproof	IP67 Watertight Cee Series straight	IP67 Watertight angled	IP44 Splashproof Cee Series straight	IP44 Splashproof topTER angled	IP67 Watertight straight	IP67 Watertight straight	IP67 Watertight topTER angled	IP67 Watertight Cee Series angled
16	50-60	110 100+130	2P+E	4	PM16/790			PM16/3000FPB	488124	PM16/660		489124	471263
			3P+E				441611	488134		489134	471273		
			3P+N+E				451611	488144		489144	471223		
		230 200+250	2P+E	6	PM16/791			PM16/3100FPB	488126	PM16/661		489126	471363
			3P+E				441622	488139		489139	471373		
			3P+N+E				451622	488149		489149	471333		
		400 380+415	2P+E	9				431638	488129			489129	471463
			3P+E		PM16/795		PM16/3500FPB	488136	PM16/665	489136	471473		
			3P+N+E		PM16/798		PM16/3800FPB	488146	PM16/668	489146	471483		
		500 480+500	2P+E	7									471553
			3P+E								471573		
			3P+N+E								471563		
32	50-60	110 100+130	2P+E	4	PM32/790			PM32/3000FPB	488224	PM32/660		489224	471267
			3P+E				443211	488234		489234	471277		
			3P+N+E				453211	488244		489244	471287		
		230 200+250	2P+E	6	PM32/791			PM32/3100FPB	488226	PM32/661		489226	471367
			3P+E				443222	488239		489239	471377		
			3P+N+E				453222	488249		489249	471387		
		400 380+415	2P+E	9				433328	488229			489229	471467
			3P+E		PM32/795		PM32/3500FPB	488236	PM32/665	489236	471477		
			3P+N+E		PM32/798		PM32/3800FPB	488246	PM32/668	489246	471487		
		500 480+500	2P+E	7									471556
			3P+E								471577		
			3P+N+E								471567		
63	50-60	110 100+130	2P+E	4		476207				436311		536311	
			3P+E			476217			446311		546311		
			3P+N+E			476227			456311		556311		
		230 200+250	2P+E	6		476307	PM63/751			PM63/661		536322	
			3P+E			476317			446332		546322		
			3P+N+E			476327			456322		556322		
		400 380+415	2P+E	9		476407				436338		536338	
			3P+E			746338	PM63/755		PM63/665		546338		
			3P+N+E			756338	PM63/758		PM63/668		556338		
		500 480+500	3P+E	7		476517						546350	
			3P+N+E										
125	50-60	110 100+130	2P+E	4						PM125/660			
			3P+E			476218			449311		549311		
			3P+N+E			476228			459311		559311		
		230 200+250	2P+E	6			PM125/751			PM125/661			
			3P+E			476318			449322		549322		
			3P+N+E			476328			459322		559322		
		400 380+415	3P+E	6		749538	PM125/755			PM125/665		549538	
			3P+N+E			459538	PM125/758		PM125/668		559538		
		500 480+500	3P+E	7		749550						549550	

INDUSTRIAL PLUGS & SOCKETS

MOULDED IEC 60309

THE TECHNIQUE

MULTIMAX SERIES - PROTECTED INDUSTRIAL PLUGS AND SOCKET-OUTLETS



DESIGN PLUS

Design Plus Prize
Frankfurt

The body of the Multimax socket-outlets and plugs are made of technopolymers with high resistance to impacts and crushing, ensuring dimensional stability and resistance to accidental treading. In addition to their safety of operation and durability, which are much higher than the minimum limits prescribed by the standards in force, Multimax plugs are characterized by easy dismantling, wiring and reassembly. The body containing the insert is fixed to the grip containing the stepped gland by 1/4 of a turn screw system. The insert terminals point in one direction to speed up cable tightening. The cable easily fits into the cord grip and the seal is obtained by manually tightening the ring nut. All these operations require less than approx. 20 seconds, which is about 1/4 of the time needed for connecting ordinary plugs. Safety is priceless and the time saved in assembly is money saved.

THE ADVANTAGES

3 GOOD REASONS FOR CHOOSING MULTIMAX

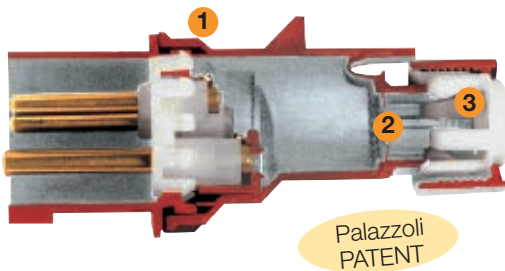

- 1 SPEED IN ASSEMBLING THE GRIP performed without tools, with 1/4 of a turn snaplock function.
- 2 GUARANTEE THAT THE CABLE REMAINS SECURE OVER TIME the cord grip with the ring nut locking device prevents accidental loosening of the cable.
- 3 SAFETY OF PROTECTION RATING even when the cable is under strain, thanks to an impossible to lose, screwless radial clamping cord grip. The membrane gasket works before the cord grip inside the grip.

WIRING TIME: 19 SECONDS!!

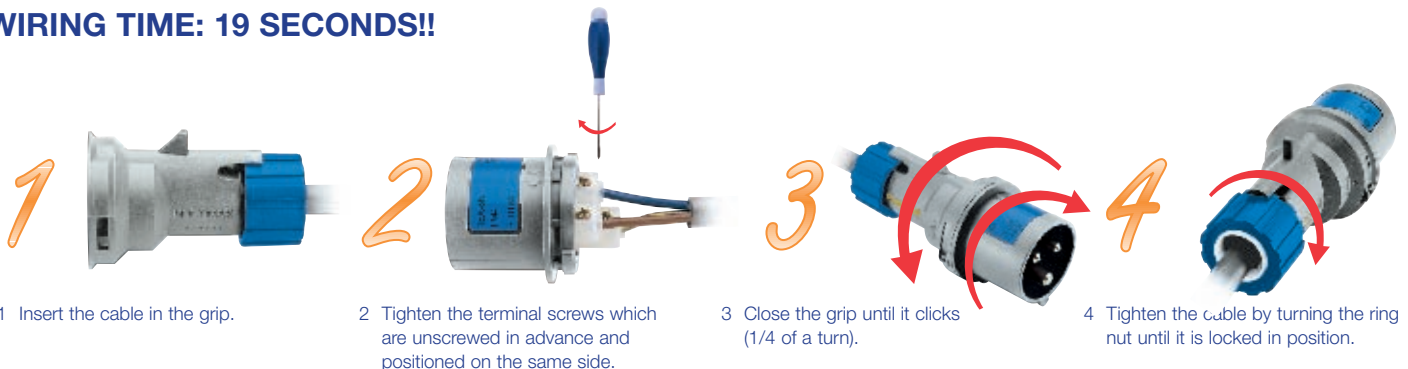

1 Insert the cable in the grip.

2 Tighten the terminal screws which are unscrewed in advance and positioned on the same side.

3 Close the grip until it clicks (1/4 of a turn).

4 Tighten the cable by turning the ring nut until it is locked in position.

ON HIGH CURRENT 63A AND 125A



The multi-lamellar crown in silver coated copper-beryllium alloy guarantees:

- wider pit-plug surface contact;
- easy removal of the plugs from the sockets;
- perfect cleaning of the plug;
- a hard-wearing, long-lasting electric contact.

INDUSTRIAL PLUGS & SOCKETS

PLUGS AND CONNECTORS MULTIMAX RAPID WIRING

Conformity to Standards:	CEI EN 60309-1	IEC 60309-1	Cable entry	16A	2P+E	min: 8	max: 13 mm
	CEI EN 60309-2	IEC 60309-2			3P+E	min: 8.5	max: 14 mm
	CEI EN 60529	IEC 60529			3P+N+E	min: 10	max: 15.5 mm
Impact resistance:	>IK 08			32A	2P+E	min: 11.5	max: 17.5 mm
Glow wire test:	850°C insert				3P+E	min: 12.5	max: 19.5 mm
Self extinguishing:	V2				3P+N+E	min: 14	max: 21.5 mm
Temperature resistance:	Operating	-25 to +50°C	Connecting sections of the wires	16A		min: 1	max: 2.5mm ²
	Storage	-30 to +70°C			32A		min: 2.5



Multimax Series

- Manufactured from thermoplastic material, suitable for general use applications.
- An economic range of plugs & connectors for trailing leads range covering 16A, 32A & 63A ratings.
- Fast & simple assembly & wiring (typically 19 seconds), supporting lower installation costs.
- Durable construction with high resistance to mechanical impact.
- Available in both IP44 & IP67 versions.
- Screwless radial cord grip technology.
- Quarter turn snap lock body shell.

MOULDED IEC 60309 PLUGS

IP44 Splashproof - Multimax





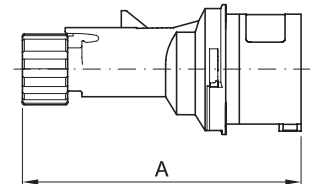

A	V	 2P+E	 3P+E	 3P+N+E
16	110	PM16/1000FPB	700134	700144
	230	PM16/1100FPB	700139	700149
	400	700129	PM16/1500FPB	PM16/1800FPB
32	110	PM32/1000FPB	700234	700244
	230	PM32/1100FPB	700239	700249
	400	700229	PM32/1500FPB	PM32/1800FPB

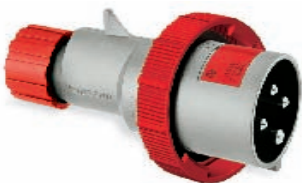

Rated current (A)	Poles	A (mm)
16	2P+E	127
	3P+E	134
	3P+N+E	142
32	2P+E	154
	3P+E	154
	3P+N+E	173

IP67 Watertight - Multimax



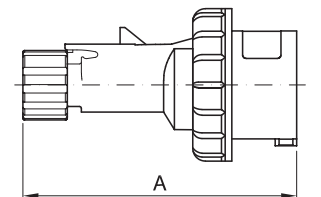

A	V	 2P+E	 3P+E	 3P+N+E
16	110	710124		
	230	710126		
	400		710136	710146
32	110	710224		
	230	710226		
	400		710236	710246



Rated current (A)	Poles	A (mm)
16	2P+E	135
	3P+E	140
	3P+N+E	150
32	2P+E	165
	3P+E	165
	3P+N+E	170

IP67 Watertight - Multimax



A	V	 2P+E	 3P+E	 3P+N+E
63	230	710326		
	400		710336	710346

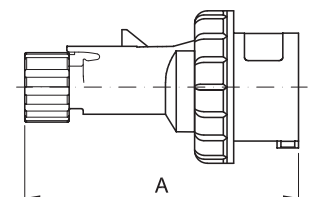



Rated current (A)	Poles	A (mm)
63	2P+E	250
	3P+E	250
	3P+N+E	250

INDUSTRIAL PLUGS & SOCKETS

MOULDED IEC 60309 PLUGS AND CONNECTORS

IP44 Splashproof - Multimax



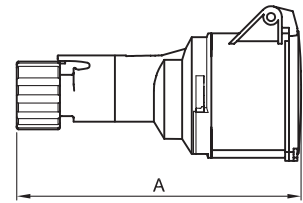

A	V	 2P+E	 3P+E	 3P+N+E
16	110	PM16/2000FPB	720134	720144
	230	PM16/2100FPB	720139	720149
	400	720129	PM16/2500FPB	PM16/2800FPB
32	110	PM32/2000FPB	720234	720244
	230	PM32/2100FPB	720239	720249
	400	720229	PM32/2500FPB	PM32/2800FPB



Rated current (A)	Poles	A (mm)
16	2P+E	134
	3P+E	143
	3P+N+E	151
32	2P+E	163
	3P+E	163
	3P+N+E	182

IP67 Watertight - Multimax



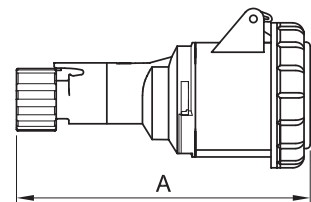

A	V	 2P+E	 3P+E	 3P+N+E
16	110	730124		
	230	730126		
	400		730136	730146
32	110	730224		
	230	730226		
	400		730236	730246



Rated current (A)	Poles	A (mm)
16	2P+E	145
	3P+E	150
	3P+N+E	165
32	2P+E	180
	3P+E	180
	3P+N+E	185

IP67 Watertight - Multimax



A	V	 2P+E	 3P+E	 3P+N+E
63	230	730326		
	400		730336	730346

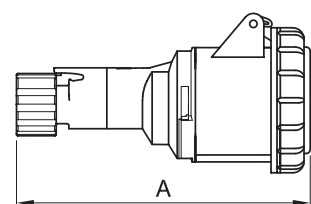

Rated current (A)	Poles	A (mm)
63	2P+E	270
	3P+E	270
	3P+N+E	270

INDUSTRIAL PLUGS & SOCKETS

PLUGS AND CONNECTORS - HEAVY DUTY

Conformity to Standards:	BS EN 60309-1	IEC 60309-1	Cable entry	63A	2P+E	min: 17	max: 26 mm
	BS EN 60309-2	IEC 60309-2			3P+E	min: 19	max: 28.5mm
	BS EN 60529	IEC 60529			3P+N+E	min: 21	max: 31.5mm
Impact resistance:	>IK 08			125A	2P+E	min: 26	max: 39.5mm
Glow wire test:	850°C				3P+E	min: 28.5	max: 43.5mm
Temperature resistance:	Operating	-25 to +50°C	Connecting sections of the wires	63A	3P+N+E	min: 31	max: 46 mm
	Storage	-40 to +80°C			125A		min: 6
						min: 16	max: 50 mm ²



Cee Series

- A high performance & heavy duty plug & socket range covering 16 to 125A ratings.
- Suitable for frequent use in the presence of knocks, vibrations, chemical agents, liquids, & dust.
- Constructed from high grade thick walled thermosetting material.
- Easy contact technology incorporated on 63 & 125A rated products.
- Non ageing elastomer sealing gaskets.
- Plugs & connectors for trailing leads feature a threaded entry gland design.
- Available in both IP44 & IP67 versions.

MOULDED IEC 60309 PLUGS

IP44 Splashproof - glanded



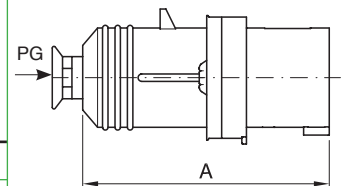

A	V			
		2P+E	3P+E	3P+N+E
16	110	PM16/500FPB	477212	477222
	230	PM16/501FPB	477312	477322
	400	477402	PM16/505FPB	PM16/508FPB
32	110	PM32/500FPB	477215	477225
	230	PM32/501FPB	477315	477325
	400	477405	PM32/505FPB	PM32/508FPB



Rated current (A)	Poles	A (mm)	PG
16	2P+E	112	13.5
	3P+E	117	16
	3P+N+E	124	16
32	2P+E	141	21
	3P+E	141	21
	3P+N+E	141	21

IP44 Splashproof - angled



A	V			
		2P+E	3P+E	3P+N+E
16	110	475202	475212	475222
	230	475302	475312	475322
	400	475402	475412	475422

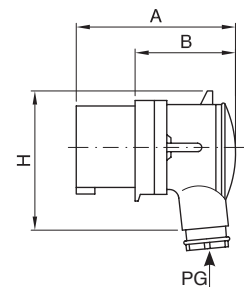



Rated current (A)	Poles	A (mm)	B (mm)	H (mm)	PG
16	2P+E	89	52	73	13.5
	3P+E	97	60	84	16
	3P+N+E	102	65	93	16

INDUSTRIAL PLUGS & SOCKETS

IP67 Watertight - angled



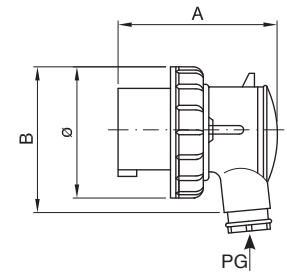

A	V			
16	110	475203	475213	475223
	230	475303	475313	475323
	400	475403	475413	475423



Rated current (A)	Poles	A (mm)	B (mm)	ø (mm)	PG
16	2P+E	97	79	73	13.5
	3P+E	97	90	80	16
	3P+N+E	102	100	88	16

IP67 Watertight - glanded



A	V			
16	110	477203	477213	477223
	230	477303	477313	477323
	400	477403	477413	477423
	500	477273	477513	477523
32	110	477206	477216	477226
	230	477306	477316	477326
	400	477406	477416	477426
	500	477556	477516	477526
63	110	477207	477217	477227
	230	477307	477317	477327
	400	477407	477417	477427
	500		477517	
125	110		477218	477228
	230		477318	477328
	400		249538	259538
	440-460			477538
	500		249550	

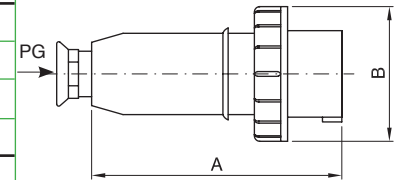



Rated current (A)	Poles	A (mm)	B (mm)	PG
16	2P+E	112	73	13.5
	3P+E	117	80	16
	3P+N+E	124	88	16
32	2P+E	141	94	21
	3P+E	141	94	21
	3P+N+E	141	101	21
63	2P+E	208	110	29
	3P+E			
	3P+N+E			
125	2P+E	283	126	2" GAS
	3P+E			
	3P+N+E			

The above plugs are fitted with a glanded entry and elastomer cable seal

IP67 Watertight - external cable clamp entry



A	V			
63	230	PM63/601		
	400		PM63/605	PM63/608
125	230	PM125/601		
	400		PM125/605	PM125/608

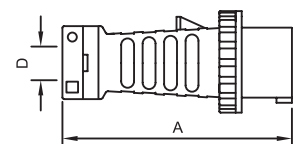
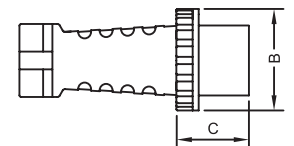

D= MAX CABLE DIAMETER

Rated current (A)	Poles	A (mm)	B (mm)	C (mm)	D (mm)
63	2P+E	238	110	75	31.5
	3P+E	238	110	75	31.5
	3P+N+E	238	110	75	31.5
125	2P+E	315	119	88	45
	3P+E	315	119	88	45
	3P+N+E	315	119	88	45



- Available in 63 & 125A ratings.
- The external cable clamp arrangement ensures a superior cable retention system, & allows acceptance of a wide range of cable diameters.

INDUSTRIAL PLUGS & SOCKETS

MOULDED IEC 60309 CONNECTORS

IP67 Watertight - glanded



A	V	 2P+E	 3P+E	 3P+N+E
16	110	473203	473213	473223
	230	473303	473313	473323
	400	473403	473413	473423
	500	473503	473513	473523
32	110	473206	473216	473226
	230	473306	473316	473326
	400	473406	473416	473426
	500	473506	473516	473526
63	110	473207	473217	473227
	230	473307	473317	473327
	400	473407	346338	356338
	500		346350	
125	110		473218	473228
	230		473318	477328
	400		349538	359538
	500		349550	

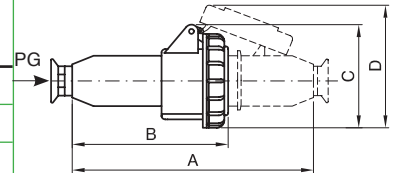



Rated current (A)	Poles	A (mm)	B (mm)	C (mm)	D (mm)	PG
16	2P+E	185	120	82	100	13.5
	3P+E	195	124	90	107	16
	3P+N+E	200	124	100	117	16
32	2P+E	238	153	105	125	21
	3P+E			110	130	
	3P+N+E					
63	2P+E	375	248	120	150	29
	3P+E					
	3P+N+E					
125	2P+E	483	290	130	168	2" GAS
	3P+E					
	3P+N+E					

The above plugs are fitted with a glanded entry and elastomer cable seal.

IP67 Watertight - external cable clamp entry



A	V	 2P+E	 3P+E	 3P+N+E
63	230	PM63/801		
	400		PM63/805	PM63/808
125	230	PM125/801		
	400		PM125/805	PM125/808

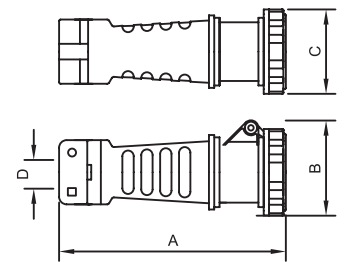

D= MAX CABLE DIAMETER

Rated current (A)	Poles	A (mm)	B (mm)	C (mm)	D (mm)
63	2P+E	255	113	110	31.5
	3P+E	255	113	110	31.5
	3P+N+E	255	113	110	31.5
125	2P+E	350	128	119	45
	3P+E	350	128	119	45
	3P+N+E	350	128	119	45

INDUSTRIAL PLUGS & SOCKETS



SURFACE APPLIANCE INLETS

Conformity to Standards:	BS EN 60309-1	IEC 60309-1	Cable entry	16A	2P+E & 3P+E	M20 Threaded
	BS EN 60309-2	IEC 60309-2		32A	3P+N+E	M25 Threaded
	BS EN 60529	IEC 60529		32A		M25 Threaded
Impact resistance:	>IK 06		Connecting sections of the wires	16A	min: 1	max: 2.5mm ²
Glow wire test:	850°C			32A	min: 2.5	max: 6 mm ²
Temperature resistance:	Operating	-25 to +50°C				
	Storage	-30 to +70°C				

MOULDED IEC 60309 SURFACE APPLIANCE INLETS

IP44 Splashproof Compact - angled



A	V			
16	110	PM16/780		
	230	PM16/781		
32	110	PM32/780		
	230	PM32/781		

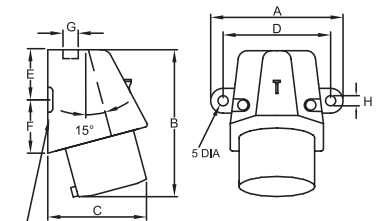



BLIND KNOCKOUT FOR REAR CABLE ENTRY 20/25mm

(A)	Poles	mm.							
		A	B	C	D	E	F	G	H
16	2P+E	86	103	69	69	37	35	M20	18
	32	2P+E	89	125	85	65	32	51	M25

IP44 Splashproof - angled



A	V			
16	400		PM16/785N	PM16/788N
32	400		PM32/785N	PM32/788N

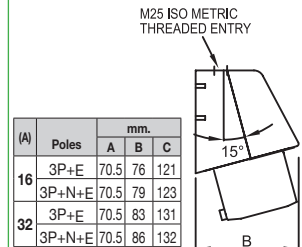

(A)	Poles	mm.		
		A	B	C
16	3P+E	70.5	76	121
	3P+N+E	70.5	79	123
32	3P+E	70.5	83	131
	3P+N+E	70.5	86	132

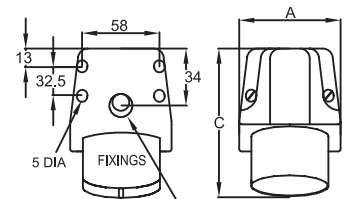







KNOCKOUT IN REAR WALL 20/25MM DIA

INDUSTRIAL PLUGS & SOCKETS

IP67 Watertight - angled



A	V			
16	110	PM16/740		
	230	PM16/741		
	400		PM16/745	PM16/748
32	110	PM32/740		
	230	PM32/741		
	400		PM32/745	PM32/748

A	V			
63	230	PM63/741N		
	400		PM63/745N	PM63/748N

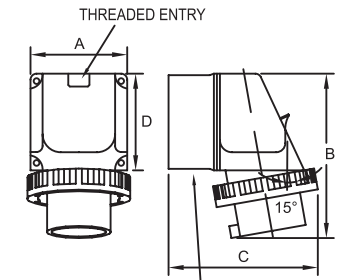

(A)	mm.					
	A	B	C	D	ENTRY	KNOCKOUTS
16	81	139	115	100	PG21	2x PG16
32	107	180	137	131	PG21	2x PG21

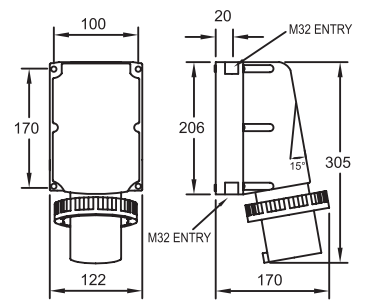

IP67 Watertight - angled



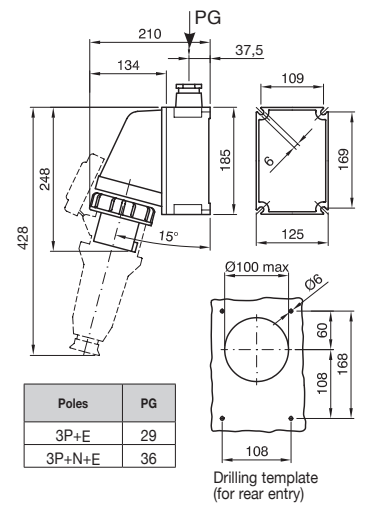

A	V			
63	400		745338	755338



Poles	PG
3P+E	29
3P+N+E	36

Drilling template (for rear entry)



A	V			
125	230	PM125/741N		
	400		748538	PM125/748FPB

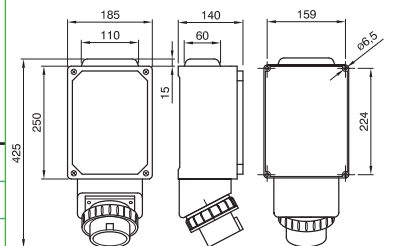

Note: IP classification of appliance inlets is tested when the connector is fully inserted.
For anti contamination caps see page 30

INDUSTRIAL PLUGS & SOCKETS



SURFACE SOCKETS

Conformity to Standards:	BS EN 60309-1	IEC 60309-1	Cable entry	16A	2P+E & 3P+E	M20 Threaded
	BS EN 60309-2	IEC 60309-2		32A	3P+N+E	M25 Threaded
	BS EN 60529	IEC 60529		63A		M25 Threaded
Impact resistance:	>IK 06 16 & 32A - >IK 07 63 & 125A					M32 Threaded
Glow wire test:	850°C					
Temperature resistance:	Operating	-25 to +50°C		16A	min: 1.5	max: 4 mm ²
	Storage	-30 to +70°C		32A	min: 2.5	max: 10 mm ²
				63A	min: 6	max: 25 mm ²

MOULDED IEC 60309 SURFACE SOCKETS

IP44 Splashproof - angled



A	V			
16	110	PM16/540N		
	230	PM16/541N		
	400		PM16/545	PM16/548
32	110	PM32/540		
	230	PM32/541		
	400		PM32/545	PM32/548

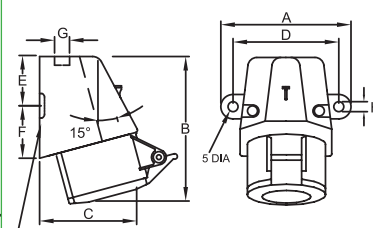



BLIND KNOCKOUT FOR REAR CABLE ENTRY 20/25mm

(A)	Poles	mm.							
		A	B	C	D	E	F	G	H
16	2P+E	86	121	88	69	37	35	M20	5.3
	3P+E	94	125	97	77	37	35	M20	5.3
	3P+N+E	89	128	104	65	32	51	M25	5.3
32	2P+E	89	138	107	65	32	51	M25	5.3
	3P+E	89	138	107	65	32	51	M25	5.3
	3P+N+E	89	138	107	65	32	51	M25	5.3

IP44 Splashproof - heavy duty wall mounted



A	V			
16	110	471262	471272	471222
	230	471362	471372	471332
	400	471462	471472	471482
	500	471552	471572	471562
32	110	471266	471276	471286
	230	471366	471376	471386
	400	471466	471476	471486
	500	471555	471576	471566

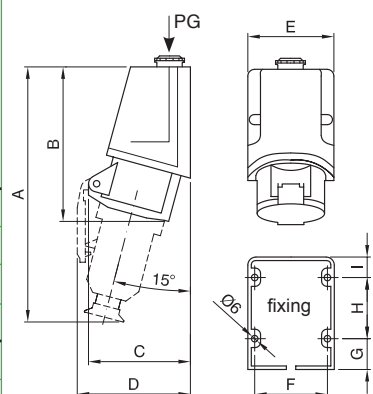



(A)	Poles	mm.									
		A	B	C	D	E	F	G	H	I	PG
16	2P+E	220	125	80	90	65	54	25	44	16	13.5
	3P+E	220	134	88	99	75	64	28	52	16	16
	3P+N+E	220	134	92	105	75	64	28	52	16	16
32	2P+E	256	154	100	115	84	72	31.5	56	22.5	21
	3P+E	256	154	100	115	84	72	31.5	56	22.5	21
	3P+N+E	258	155	103	120	84	72	31.5	56	22.5	21

INDUSTRIAL PLUGS & SOCKETS

IP44 Splashproof - topTER Series wall mounted



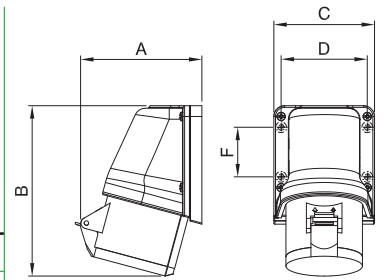

A	V			
16	110	508124		
	230	508126		
	400		508136	508146
32	110	508224		
	230	508226		
	400		508236	508246



(A)	Poles	mm.					
		A	B	C	D	F	G
16	2P+E	101	146	93,5	80	46	5,5
	3P+E	104	146	93,5	80	46	5,5
	3P+N+E	107	147	93,5	80	46	5,5
32	2P+E	114	157	93,5	80	46	5,5
	3P+E	114	157	93,5	80	46	5,5
	3P+N+E	116	158	93,5	80	46	5,5

IP67 Watertight - topTER Series wall mounted



A	V			
16	110	509124		
	230	509126		
	400		509136	509146
32	110	509224		
	230	509226		
	400		509236	509246
63	400	509326	509336	509346

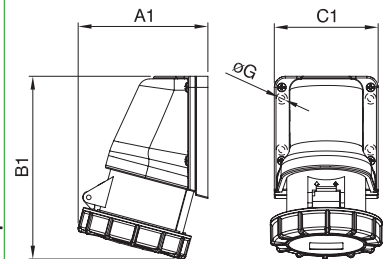



(A)	Poles	mm.					
		A 1	B 1	C 1	D	F	G
16	2P+E	101	146	93,5	80	46	5,5
	3P+E	104	146	93,5	80	46	5,5
	3P+N+E	107	147	93,5	80	46	5,5
32	2P+E	114	157	93,5	80	46	5,5
	3P+E	114	157	93,5	80	46	5,5
	3P+N+E	116	158	93,5	80	46	5,5
63	ALL	171	230	118	106	158	6

INDUSTRIAL PLUGS & SOCKETS

IP67 Watertight - wall mounted



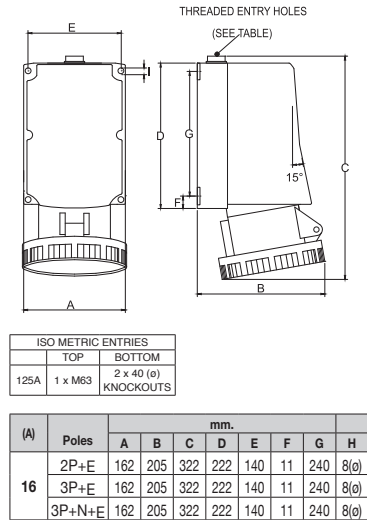

A	V	 2P+E	 3P+E	 3P+N+E
63	230	PM63/641		
	400		PM63/645	PM63/648
125	110	PM125/640	PM125/643	PM125/646
	230	PM125/641	PM125/644	PM125/647
	400	PM125/642	PM125/645	PM125/648



IP67 Watertight - wall mounted



A	V	 2P+E	 3P+E	 3P+N+E
63	400		445338	455338

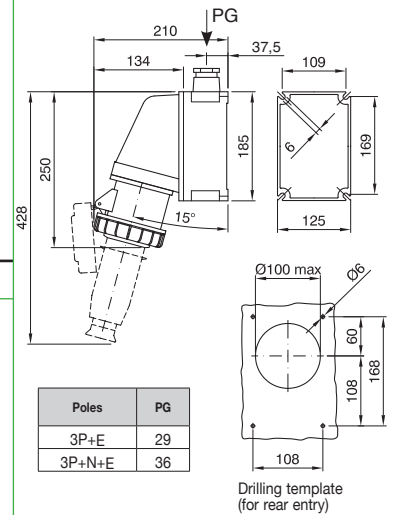

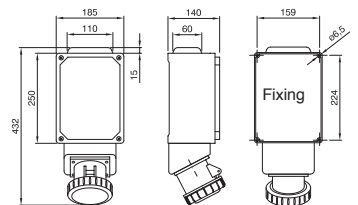

A	V	 2P+E	 3P+E	 3P+N+E
125	400		448538	458538



INDUSTRIAL PLUGS & SOCKETS

IP44 Splashproof - Ter Series wall mounted - angled



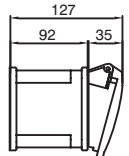
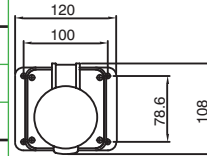

A	V	 2P+E	 3P+E	 3P+N+E
16	110	PM16/530FPB	485134	485144
	230	PM16/531FPB	485139	485149
	400	485129	485136	485146
32	110	485224	485234	485244
	230	485226	485239	485249
	400	485229	485236	485246



- Smooth walls undrilled
- Cable Entry possible on all 4 faces plus rear
- Generous wiring space

IP67 Watertight - Ter Series wall mounted - angled



A	V	 2P+E	 3P+E	 3P+N+E
16	110	487124	487134	487144
	230	487126	487139	487149
	400	487129	487136	487146
32	110	487224	487234	487244
	230	487226	487239	487249
	400	487229	487236	487246

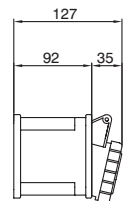
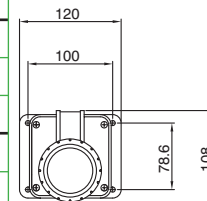

- Smooth walls undrilled
- Cable Entry possible on all 4 faces plus rear
- Generous wiring space

INDUSTRIAL PLUGS & SOCKETS



PANEL APPLIANCE INLETS

Conformity to Standards:	BS EN 60309-1	IEC 60309-1	Temperature resistance:	Operating	-25 to +50°C	
	BS EN 60309-2	IEC 60309-2		Storage	-30 to +70°C	
	BS EN 60529	IEC 60529				
Impact resistance:	>IK 06 16 & 32A - >IK 07 63 & 125A		Connecting sections of the wires	16A	min: 1	max: 2.5mm ²
Glow wire test:	850°C			32A	min: 2.5	max: 6 mm ²
				63A	min: 6	max: 16 mm ²
				125A	min: 16	max: 50 mm ²

MOULDED IEC 60309 PANEL APPLIANCE INLETS

IP44 Splashproof



A	V	 2P+E	 3P+E	 3P+N+E
16	110	PM16/790		
	230	PM16/791		
	400		PM16/795	PM16/798
32	110	PM32/790		
	230	PM32/791		
	400		PM32/795	PM32/798

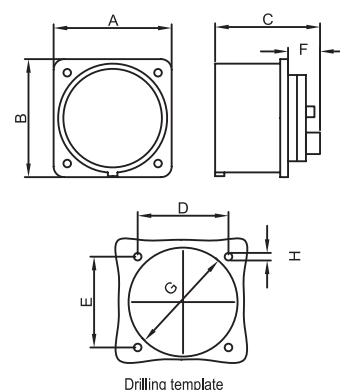



(A)	Poles	V	mm.							
			A	B	C	D	E	F	G(ø)	H(ø)
16	2P+E	110	70	70	66	56	56	25	43	5.5
	2P+E	230	77	77	65	60	60	8.5	40	5.5
	3P+E	All	70	70	66	56	56	25	43	5
	3P+N+E	All	70	70	68	56	56	26	55	5
32	2P+E	All	70	70	80	56	56	30	55	5
	3P+E	All	70	70	80	56	56	30	55	5
	3P+N+E	All	70	70	80	56	56	30	55	5

Note: IP classification of appliance inlets is tested when the connector is fully inserted.
For anti contamination caps see page 30

INDUSTRIAL PLUGS & SOCKETS

IP67 Watertight - straight



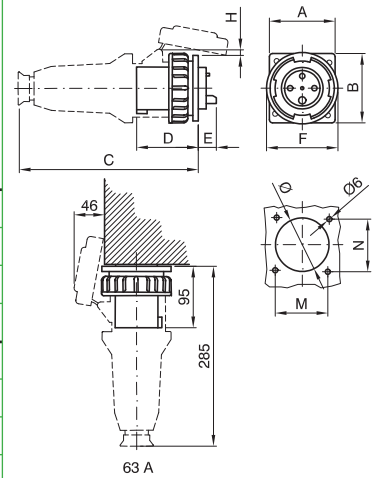

A	V			
63	110	476207	476217	476227
	230	476307	476317	476327
	400	476407	746338	756338
	500		476517	
125	110		476218	476228
	230		476318	476328
	400		749538	759538
	500		749550	



Rated current (A)	mm.								
	A	B	C	D	E	F	M	H	Ø
63	100	108	285	95	26	110	77	10	85
125	114	114	355	118	67	126	90	10	98

IP67 Watertight - angled



A	V			
63	230	PM63/751		
	400		PM63/755	PM63/758
125	230	PM125/751		
	400		PM125/755	PM125/758

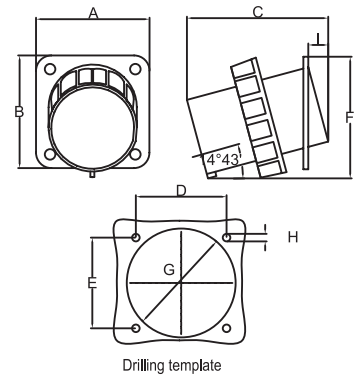

Drilling template

(A)	Poles	mm.								
		A	B	C	D	E	F	G	H(e)	I
63	2P+E	100	112	135	80	88	127	80	7	8
	3P+E	100	112	135	80	88	127	80	7	8
	3P+N+E	100	112	135	80	88	127	80	7	8
125	2P+E	120	130	147	100	108	145	80	7	8
	3P+E	120	130	147	100	108	145	80	7	8
	3P+N+E	120	130	147	100	108	143	80	7	8

Note: IP classification of appliance inlets is tested when the connector is fully inserted.
For anti contamination caps see page 30

INDUSTRIAL PLUGS & SOCKETS



PANEL SOCKETS

Conformity to Standards:	BS EN 60309-1	IEC 60309-1	Temperature resistance:	Operating	-25 to +50°C	
	BS EN 60309-2	IEC 60309-2		Storage	-30 to +70°C	
	BS EN 60529	IEC 60529				
Impact resistance:	>IK 06 16 & 32A - >IK 07 63 & 125A		Connecting sections of the wires	16A	min: 1.5	max: 4 mm ²
Glow wire test:	850°C			32A	min: 2.5	max: 10 mm ²
				63A	min: 6	max: 25 mm ²
				125A	min: 25	max: 70 mm ²

MOULDED IEC 60309 PANEL SOCKETS

IP44 Splashproof - straight



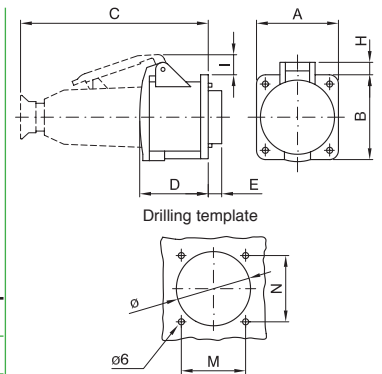

A	V			
		2P+E	3P+E	3P+N+E
16	110	PM16/3000FPB	441611	451611
	230	PM16/3100FPB	441622	451622
	400	431638	PM16/3500FPB	PM16/3800FPB
32	110	PM32/3000FPB	443211	453211
	230	PM32/3100FPB	443222	453222
	400	433238	PM32/3500FPB	PM32/3800FPB



(A)	Poles	mm.									
		A	B	C	D	E	H	I	M	N	ø
16	2P+E	62	62	130	47	18	8	18	47	47	50
	3P+E	75	75	130	47	18	8	18	60	60	63
	3P+N+E	75	75	140	47	18	10	20	60	60	63
32	2P+E	75	75	170	62	18	12	20	60	60	63
	3P+E	75	75	170	62	18	12	20	60	60	63
	3P+N+E	75	75	170	62	18	15	26	60	60	63

IP67 Watertight - straight



A	V			
		2P+E	3P+E	3P+N+E
16	110	PM16/660		
	230	PM16/661		
	400		PM16/665	PM16/668
32	110	PM32/660		
	230	PM32/661		
	400		PM32/665	PM32/668

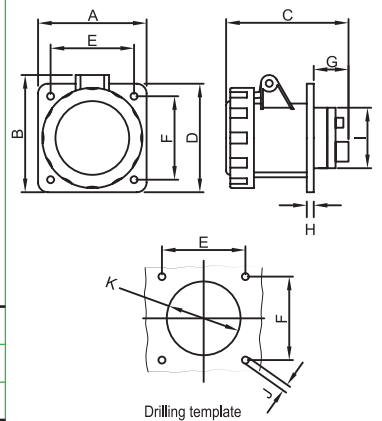



(A)	Poles	mm.										
		A	B	C	D	E	F	G	H	I	J(ø)	K
16	2P+E	78	84	74	78	60	60	14	4	43	5.5	50
	3P+E	78	88	75	78	60	60	14	4	43	5.5	50
	3P+N+E	90	98	76	90	72	72	14	6	54	5.5	60
32	2P+E	90	101	84	90	72	72	14	6	54	5.5	60
	3P+E	90	101	84	90	72	72	14	6	54	5.5	60
	3P+N+E	90	107	84	90	72	72	14	6	54	5.5	68

INDUSTRIAL PLUGS & SOCKETS

IP67 Watertight - straight



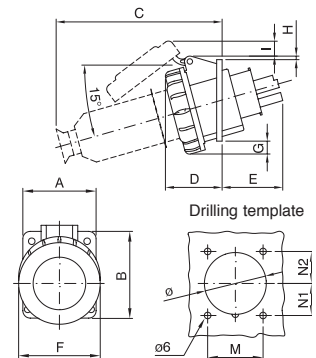

A	V			
63	110	436311	446311	456311
	230	436322	446322	456322
	400	436338	446338	456338
125	110		449311	459311
	230		449322	459322
	400		449538	459538



(A)	Poles	mm.												
		A	B	C	D	E	F	G	H	I	M	N1	N2	ø
63	All	100	108	226	80	80	109	10	8	23	77	46	39	86
125	3P+E	114	114	320	101	82	128	20	8	35	90	47	43	96
	3P+N+E													

IP44 Splashproof topTER - angled



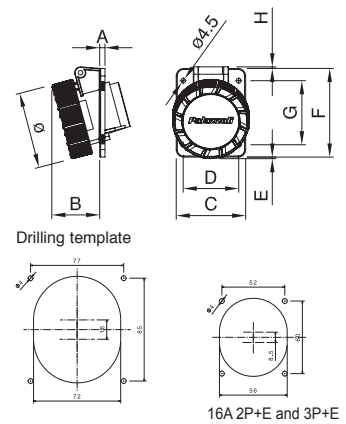

A	V			
16	110	488124	488134	488144
	230	488126	488139	488149
	400	488129	488136	488146
32	110	488224	488234	488244
	230	488226	488239	488249
	400	488229	488236	488246



(A)	Poles	mm.							
		A	B	C	D	F	G	ø	
16	2P+E	5	45	65	52	60	72	5	
	3P+E	5	46	65	52	60	72	80	
	3P+N+E	7	47	88	77	100	85	88	
32	2P+E	7	54	88	77	100	85	93	
	3P+E	7	54	88	77	100	85	93	
	3P+N+E	7	55	88	77	100	85	100	

IP67 Watertight topTER - angled



A	V			
16	110	489124	489134	489144
	230	489126	489139	489149
	400	489129	489136	489146
32	110	489224	489234	489244
	230	489226	489239	489249
	400	489229	489236	489246

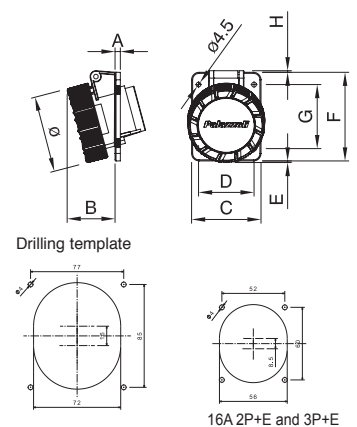

(A)	Poles	mm.							
		A	B	C	D	F	G	ø	
16	2P+E	5	45	65	52	60	72	5	
	3P+E	5	46	65	52	60	72	80	
	3P+N+E	7	47	88	77	100	85	88	
32	2P+E	7	54	88	77	100	85	93	
	3P+E	7	54	88	77	100	85	93	
	3P+N+E	7	55	88	77	100	85	100	

INDUSTRIAL PLUGS & SOCKETS

IP44 Splashproof fixed Compact Socket - outlets - angled



COMPACT BOARD SOCKET-OUTLETS

A	V	Flange dimensions mm.	 2P+E
16	110	60 x 60	488114
	230	60 x 60	488116

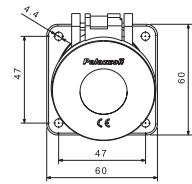

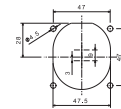

Drilling template



IP67 Watertight - Cee Series - angled



A	V	 2P+E	 3P+E	 3P+N+E
16	110	471263	471273	471223
	230	471363	471373	471333
	400	471463	471473	471483
	500	471553	471573	471563
32	110	471267	471277	471287
	230	471367	471377	471387
	400	471467	471477	471487
	500	471556	471577	471567
63	110	536311	546311	556311
	230	536322	546322	556322
	400	536338	546338	556338
	500		546350	
125	110		549311	559311
	230		549322	559322
	400		549538	559538
	500		549550	

16A 32A

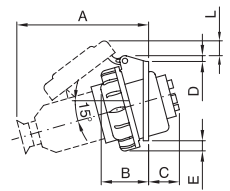

Drilling template

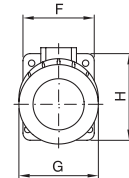

(A)	Poles	mm.												
		A	B	C	D	E	F	G	H	I	L	M	N	ø
16	2P+E	123	46	31	7	9	62	73	70	47	15	26	29	53
	3P+E	133	48	30	6	10	70	80	77	53	15	30	30	60
	3P+N+E	140	51	24	7.5	9	77	88	85	57	15	31	34	66
32	2P+E	157	56	39	3	7	85	94	97	60	20	35	37	70
	3P+E	157	56	39	3	6	85	94	97	60	20	35	37	70
	3P+N+E	158	58	38	3	7.5	90	101	105	65	20	38	42	75

63A 125A

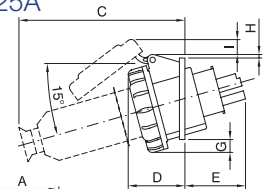

Drilling template

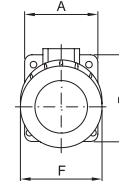



(A)	Poles	mm.												
		A	B	C	D	E	F	G	H	I	M	N1	N2	ø
63	2P+E	100	108	226	80	80	109	10	8	23	77	46	39	86
	3P+E													
	3P+N+E													
125	3P+E	114	114	320	101	82	128	20	8	35	90	47	43	96
	3P+N+E													

INDUSTRIAL PLUGS & SOCKETS

ACCESSORIES FOR MOULDED IEC 60309 APPLIANCE INLETS



IP44 Splashproof anti-contamination caps



A	 2P+E	 3P+E	 3P+N+E
16	PM16/3KC	PM16/4KC	PM16/5KC
32	PM32/3KC	PM32/4KC	PM32/5KC

IP67 Watertight anti-contamination caps



A	 2P+E	 3P+E	 3P+N+E
16	PM16/3NPCFPB	476913	476923
32	476905	476905	476925
63	PM63/345NPC		
125	PM125/345NPC		

INDUSTRIAL PLUGS & SOCKETS

SPLITTERS

Conformity to Standards:	CEI EN 60309-1	IEC 60309-1	Temperature resistance:	Operating	-25 to +50°C
	CEI EN 60309-2	IEC 60309-2		Storage	-30 to +70°C
	CEI EN 60529	IEC 60529		Cable entry	T-line: glanded for side entry 1.5mm ² x 3 core cable
Impact resistance:	>IK 06		Connecting sections of the wires	T-line: max 1.5mm ²	
Glow wire test:	850°C				

SPLITTERS

IP44 Splashproof - Splitline

- IP44 16A 110v & 230v versions to IEC60309
- 1x power inlet feeding, 3x power outlets
- Can be cable tied to rigging & piping for rapid installation
- Lightweight & compact design
- Robust construction



A	V	
16	110	PM16/A130N
	230	PM16/A131N



2P+E

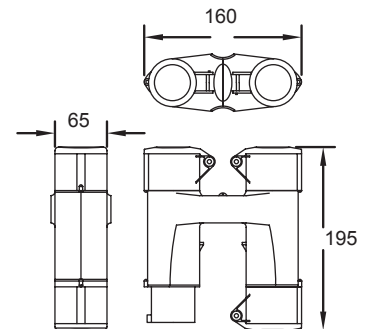

IP44 Splashproof - T-Line

- Saves time & space
- Re-wireable in line T-Connector
- IP44 16A 110v AC & 230v AC IEC60309
- Black body moulding
- Theatre, film & studio applications
- Ideal for temporary hard wired cable connection to lighting/ heating etc
- Lightweight & compact
- Robust construction



A	V	
16	110	PM16/A110T
	230	PM16/A24T



2P+E

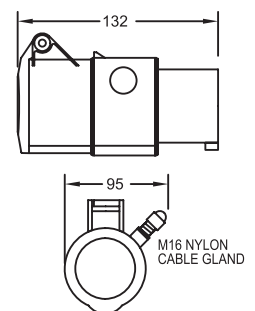

INDUSTRIAL PLUGS & SOCKETS

MULTIPLAY SERIES

Conformity to Standards:	CEI EN 60309-1	IEC 60309-1	Glow wire test:	850°C
	CEI EN 60309-2	IEC 60309-2	Self-extinguishing:	V2
	CEI 23-50	IEC 60884-1	Temperature resistance:	Operating -25 to +50°C Storage -30 to +70°C
Protection rating:	IP67 (multipliers) IPX0 (adaptors)			
Impact resistance:	> IK 08			



Multiplay – Multipliers & Adaptors

The new Multiplay series was designed & built to power mobile & portable appliances fitted with industrial plugs & multiply power distribution for all temporary uses. The main advantages consist in the single- block unit which prevents corrosive atmospheres from penetrating inside the shell.

MULTIPLIERS & ADAPTORS



IP67 Watertight - 2 Gang



A	V	 2P+E	 3P+E	 3P+N+E
16	230	752126		
	400		752136	752146

IP67 Watertight - 3 Gang



A	V	 2P+E	 3P+E	 3P+N+E
16	230	753126		
	400		753136	753146
32	400		753236	

IP44 Splashproof Plug adaptors - 1/2 Socket-Outlets for domestic use



A	V	 2P+E	 3P+E	 3P+N+E
16	230	740001		

IP44 Splashproof Plug adaptors - 1 Standard British Socket-Outlet



A	V	 2P+E	 3P+E	 3P+N+E
13	230	740003		

INDUSTRIAL PLUGS & SOCKETS

LOW VOLTAGE

Conformity to Standards:	CEI EN 60309-1	IEC 60309-1	Cable entry	16A	2P+E	min: 8	max: 13	mm
	CEI EN 60309-2	IEC 60309-2		32A	3P+E	min: 8.5	max: 14	mm
	CEI EN 60529	IEC 60529			3P+N+E	min: 10	max: 15.5	mm
Impact resistance:	>IK 08							
Glow wire test:	850°C insert							
Self extinguishing:	V2							
Temperature resistance:	Operating	-25 to +50°C	Connecting sections of the wires	16A		min: 1	max: 2.5	mm ²
	Storage	-30 to +70°C		32A		min: 2.5	max: 6	mm ²

Low voltage plugs & sockets

- This range of products are designed for use on systems with operating voltages less than 50V & suitable for either AC or DC supplies (by product selection).
- Plugs & connectors are available in either 2 or 3 pole versions.
- Products in this range can be distinguished by either a violet or white colour coding, signifying either 20-25V or 40-50V respectively.
- Incorrect mating of plugs & connectors within this range is prevented by two square mechanical keyways.
- A major keyway is located at 6H, & is consistent throughout the product range. An additional minor keyway is located at varying clock positions in relation to the major keyway.

LOW VOLTAGE PLUGS

IP44 Splashproof - Cee Series glanded



A	V	2 POLE	3 POLE
16	20-25	PM16/900FPB	PM16/903FPB
	40-50	477102	PM16/904FPB
	42Vdc	477602	PM16/905
32	20-25	477005	477065
	40-50	477105	477115
	42Vdc	477605	PM32/905

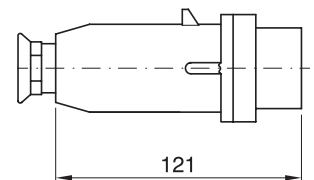

IP67 Watertight - Cee Series glanded



A	V	2 POLE	3 POLE
16	20-25	PM16/940FPB	PM16/943FPB
	40-50	477103	477113
	42Vdc	477603	
32	20-25	477006	477066
	40-50	477106	477116
	42Vdc	477606	

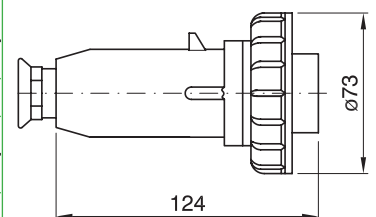

INDUSTRIAL PLUGS & SOCKETS

LOW VOLTAGE CONNECTORS AND SURFACE SOCKETS

IP44 Splashproof - Cee Series - glanded



A	V	2 POLE	3 POLE
16	20-25	473002	473062
	40-50	473102	473112
	42Vdc	473602	PM16/915
32	20-25	473005	473065
	40-50	473105	473115
	42Vdc	473605	PM32/915

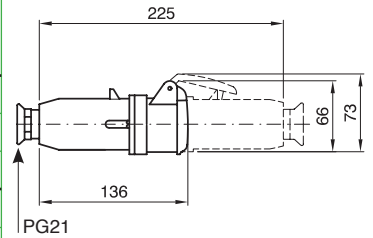

IP67 Watertight - Cee Series - glanded



A	V	2 POLE	3 POLE
16	20-25	473003	473063
	40-50	473103	473113
	42Vdc	473603	
32	20-25	473006	473066
	40-50	473106	473116
	42Vdc	473606	

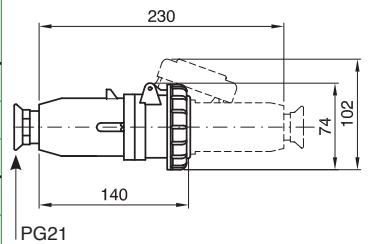

IP44 Splashproof - Cee Series - angled

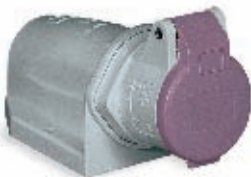

A	V	2 POLE	3 POLE
16	20-25	PM16/930FPB	PM16/933FPB
	40-50	471102	471112
	42Vdc	471602	PM16/935
32	20-25	471005	471015
	40-50	471105	471115
	42Vdc	471605	PM32/935

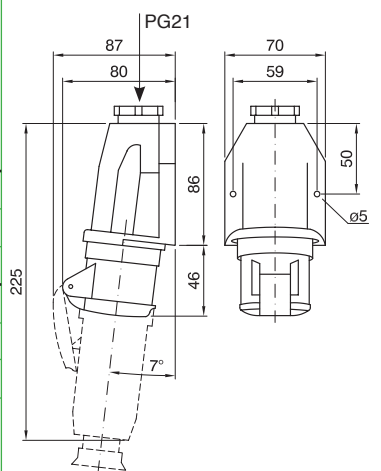

INDUSTRIAL PLUGS & SOCKETS

LOW VOLTAGE SURFACE SOCKETS AND PANEL SOCKETS

IP67 Watertight - angled



A	V	2 POLE	3 POLE
16	20-25	PM16/960	PM16/963
	42Vdc	PM16/962	PM16/964
32	20-25	PM32/960	PM32/963
	42Vdc	PM32/962	PM32/964

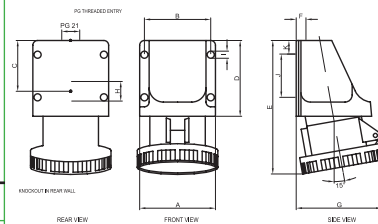

(A)	Poles	mm.										
		A	B	C	D	E	F	G	H	I	J	K
16	2P+E	70	59	32	82	118	20	82	23(ø)	5.3(ø)	33	13
	3P+E	70	59	32	82	118	20	82	23(ø)	5.3(ø)	33	13
32	2P+E	70	59	32	82	118	20	82	23(ø)	5.3(ø)	33	13
	3P+E	70	59	32	82	118	20	82	23(ø)	5.3(ø)	33	13

IP44 Splashproof Panel Socket - Cee Series - straight



A	V	2 POLE	3 POLE
16	20-25	PM16/920FPB	PM16/923FPB
	40-50	471132	471142
	42Vdc	471632	
32	20-25	471035	471045
	40-50	471135	471145
	42Vdc	471635	

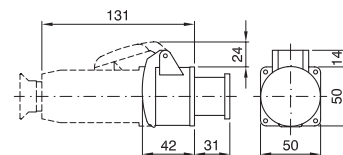

Drilling template

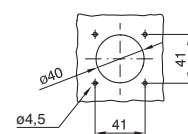

IP67 Watertight - Panel Socket - Cee Series - straight



A	V	2 POLE	3 POLE
16	20-25	471003	471063
	40-50	471103	471113
32	20-25	471007	471067
	40-50	471107	471117

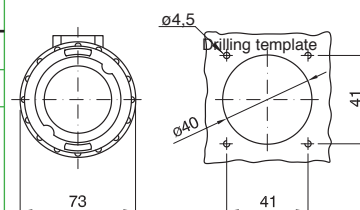
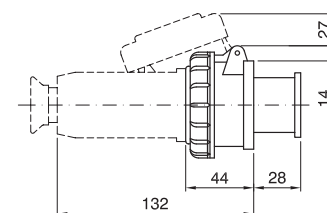

INDUSTRIAL PLUGS & SOCKETS

7 - PIN

Conformity to Standards:	BSEN 60309-1	IEC 60309-1	Cable entry	16A	2P+E	min: 8	max: 13 mm
	BSEN 60529	IEC 60529			3P+E	min: 8.5	max: 14 mm
Impact resistance:	>IK 06				3P+N+E	min: 10	max: 15.5mm
Glow wire test:	850°C			32A	2P+E	min: 11.5	max: 17.5mm
Temperature resistance:	Operating	-25 to +50°C			3P+E	min: 12.5	max: 19.5mm
	Storage	-30 to +70°C			3P+N+E	min: 14	max: 21.5mm
			Connecting sections of the wires	16A		min: 1	max: 2.5mm ²
					32A		min: 2.5

7 Pin plugs & sockets (6P+E)

- These products are available in either 230V or 400VAC operating voltage configurations.
- The 6 pins are all equally rated to carry the maximum design currents of either 16 or 32A ratings, & are generally suited to motor applications.

7 - PIN PLUGS

IP44 Splashproof - plug



A	V	
		 6P+E
16	230	PM16/71240
	400	PM16/71415
32	230	PM32/71240
	400	PM32/71415

Grommet entry

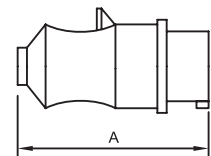

Rated current (A)	A (mm)
16	135
32	169

IP67 Watertight - plug



A	V	
		 6P+E
16	400	PM16/81415
32	400	PM32/81415

Screwed radial cord grip

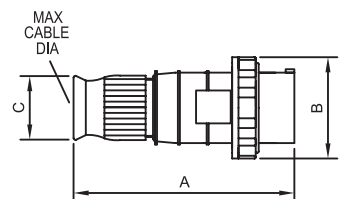

Rated current (A)	A (mm)	B (mm)	C (mm)
16	152	86(ø)	21(ø)
32	181	101(ø)	27(ø)

INDUSTRIAL PLUGS & SOCKETS

7 - PIN CONNECTORS AND SURFACE SOCKETS

IP44 Splashproof - connector



A	V	
16	230	PM16/72240
	400	PM16/72415
32	230	PM32/72240
	400	PM32/72415



6P+E

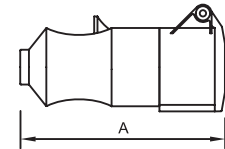

Rated current (A)	A (mm)
16	145
32	226

Grommet entry

IP67 Watertight - connector



A	V	
16	400	PM16/82415
32	400	PM32/82415



6P+E

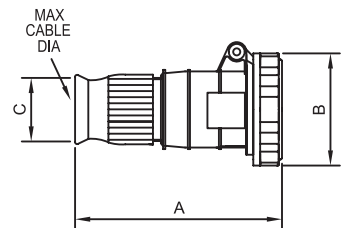

Rated current (A)	A (mm)	B (mm)	C (mm)
16	168	86.5(ø)	21(ø)
32	200	101.5(ø)	27(ø)

Screwed radial cord grip

IP44 Splashproof socket surface mounted - angled



A	V	
16	230	PM16/75240
	400	PM16/75415
32	230	PM32/75240
	400	PM32/75415



6P+E

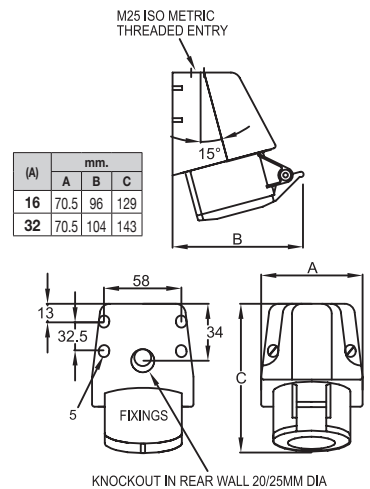

INDUSTRIAL PLUGS & SOCKETS

7 - PIN SURFACE SOCKETS AND PANEL SOCKETS

IP67 Watertight socket surface mounted - angled



A	V	
		 6P+E
16	400	PM16/85415
32	400	PM32/85415

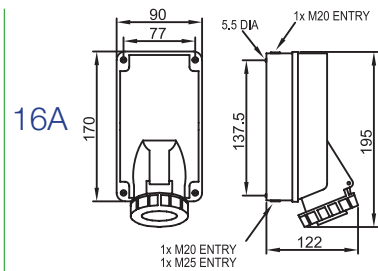

16A

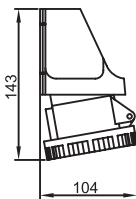

32A

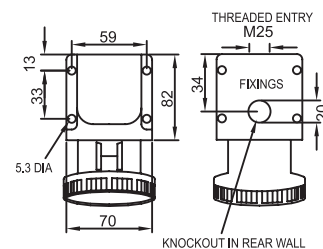

IP44 Splashproof socket panel mounted - straight



A	V	
		 6P+E
16	400	PM16/77415
32	400	PM32/77415

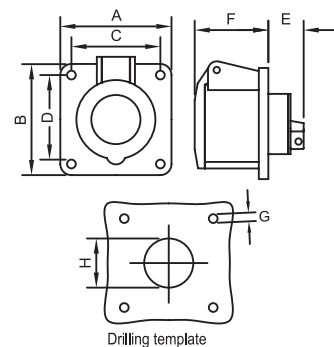

(A)	mm.							
	A	B	C	D	E	F	G	H
16	70	70	56	56	28	45	5.5	56
32	75	75	60	60	19	62	5.5	56

IP67 Watertight surface panel mounted - straight



A	V	
		 6P+E
16	400	PM16/87415
32	400	PM32/87415

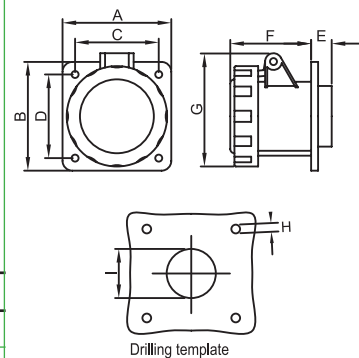

(A)	mm.								
	A	B	C	D	E	F	G	H	I
16	75	75	60	60	35.5	57	93	5.5(o)	55(o)
32	75	75	60	60	50	65	106	5.5(o)	60(o)

INDUSTRIAL PLUGS & SOCKETS

HIGH FREQUENCY

Conformity to Standards:	CEI EN 60309-1	IEC 60309-1	Cable entry	16A	2P+E	min: 8	max: 13	mm
	CEI EN 60309-2	IEC 60309-2		32A	3P+E	min: 8.5	max: 14	mm
	CEI EN 60529	IEC 60529			3P+N+E	min: 10	max: 15.5	mm
Impact resistance:	>IK 06							
Glow wire test:	850°C							
Temperature resistance:	Operating	-25 to +50°C						
	Storage	-30 to +70°C						
Connecting sections of the wires				16A		min: 1	max: 2.5	mm ²
				32A		min: 2.5	max: 6	mm ²



Multimax high frequency

- A plug & socket range available for IP44 installations.
- Suited to applications where the supply frequency is notably higher than normal mains systems, & between the ranges of 100 to 500Hz.
- Available in both 16 & 32A ratings for systems with operating voltages >50VAC.
- Plugs & trailing lead connectors in this range feature the same significant design characteristics as those in the Multimax product range.
- Products are colour coded green.

HIGH FREQUENCY PLUGS AND CONNECTORS

IP44 Splashproof plugs - Multimax



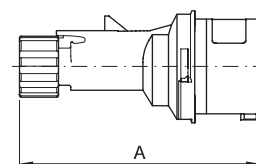

A	V	Hz	 2P+E	 3P+E	 4P+E
16	>50	100-300	700120	PM16/941FPB	700140
		300-500	700122	700132	700142
32	>50	100-300	700220	700230	700240
		300-500	700222	700232	700242



Rated current (A)	Poles	A (mm)
16	2P+E	127
	3P+E	134
	4P+E	142
32	2P+E	154
	3P+E	154
	4P+E	173

IP44 Splashproof connector - Multimax



A	V	Hz	 2P+E	 3P+E	 4P+E
16	>50	100-300	720120	720130	720140
		300-500	720122	720132	720142
32	>50	100-300	720220	720230	720240
		300-500	720222	720232	720242

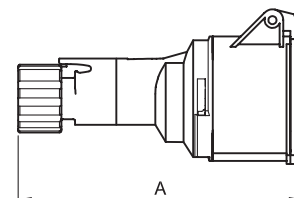



Rated current (A)	Poles	A (mm)
16	2P+E	134
	3P+E	143
	4P+E	151
32	2P+E	163
	3P+E	163
	4P+E	182

INDUSTRIAL PLUGS & SOCKETS

HIGH FREQUENCY SURFACE AND PANEL SOCKETS

IP44 Splashproof surface socket - angled



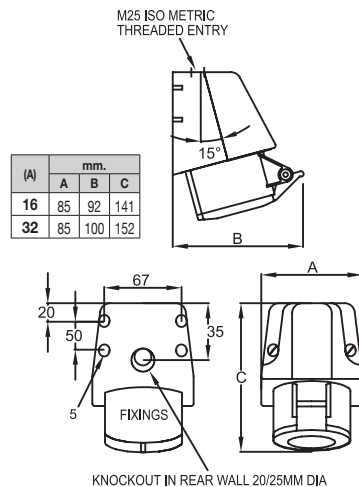

A	V	 3P+E 100-300 Hz 10h Earth	 3P+E 300-500 Hz 2h Earth
16	>50	PM16/961	PM16/965
32	>50	PM32/961	PM32/965



IP44 Splashproof panel socket - straight



A	V	 3P+E 100-300 Hz 10h Earth	 3P+E 300-500 Hz 2h Earth
16	>50	PM16/971	PM16/975
32	>50	PM32/971	PM32/975

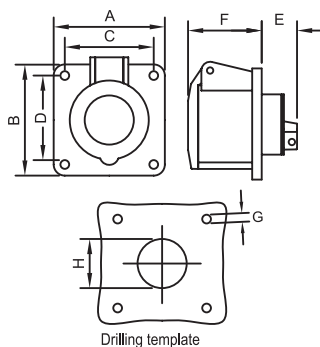

(A)	mm.							
	A	B	C	D	E	F	G	H
16	70	70	56	56	28	45	5.5	56
32	75	75	60	60	19	62	5.5	56

INDUSTRIAL PLUGS & SOCKETS

METAL 60309

Conformity to Standards:	BS EN 60309-1	IEC 60309-1	Cable entry	16A	2P+E	min: 8	max: 13 mm	
	BS EN 60309-2	IEC 60309-2			3P+E	min: 8.5	max: 14 mm	
	BS EN 60529	IEC 60529			3P+N+E	min: 10	max: 15.5mm	
Impact resistance:	>IK 06 (TOUGH ZINC DIE-CAST BODY)			32A	2P+E	min: 11.5	max: 17.5mm	
Glow wire test:	850°C insert				3P+E	min: 12.5	max: 19.5mm	
Temperature resistance:	Operating	-25 to +50°C			3P+N+E	min: 14	max: 21.5mm	
	Storage	-30 to +70°C		Connecting sections of the wires	16A	Plug	min: 1	max: 2.5mm ²
					32A	Plug	min: 2.5	max: 6 mm ²
					16A	Socket	min: 1.5	max: 4 mm ²
					32A	Socket	min: 2.5	max: 10 mm ²



Metal 60309 plugs & sockets

- An extremely mechanically robust plug & socket range suited for arduous conditions

METAL PLUGS AND SOCKETS

IP44 Splashproof - plug



A	V			
		2P+E	3P+E	3P+N+E
16	110	PD16/100		
	230	PD16/101		
	400		PD16/105	PD16/108
32	110	PD32/100		
	230	PD32/101		
	400		PD32/105	PD32/108

These products are manufactured to order only & may be subject to a minimum order quantity.

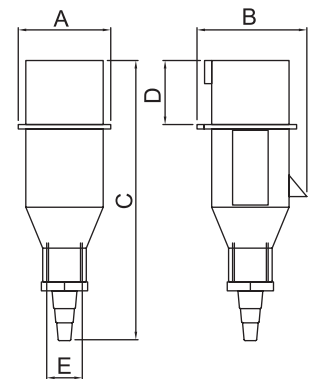



FEMALE THREADED ENTRY
NOTE: MAX CABLE TERMINATION 2.5mm²sq FOR 16A / 6mm²sq FOR 32A

(A)	Poles	mm.				
		A	B	C	D	E
16	2P+E	52	60	157	37	M20
	3P+E	58	57	158	37	M20
	3P+N+E	65	77	164	37	M32
32	2P+E	66	79	175	46	M32
	3P+E	66	79	175	46	M32
	3P+N+E	71	87	175	46	M32

IP44 Splashproof - surface socket - straight



A	V			
		2P+E	3P+E	3P+N+E
16	110	PD16/120		
	230	PD16/121		
	400		PD16/125	PD16/128
32	110	PD32/120		
	230	PD32/121		
	400		PD32/125	PD32/128

These products are manufactured to order only & may be subject to a minimum order quantity.

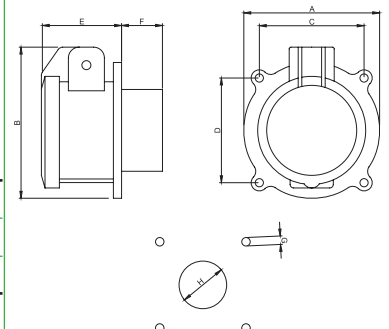

(A)	Poles	mm.							
		A	B	C	D	E	F	G	H
16	2P+E	83	86	64	64	74	30	5.5	68
	3P+E	83	86	64	64	74	30	5.5	68
	3P+N+E	83	86	64	64	74	30	5.5	68
32	2P+E	97	98	68	89	30	46	5.5	74
	3P+E	97	98	68	89	30	46	5.5	74
	3P+N+E	97	98	68	89	30	46	5.5	74

INDUSTRIAL PLUGS & SOCKETS

HIGH CURRENT

Conformity to Standards:	CEI EN 60309-1 (Where applicable)	Temperature resistance:	Operating	-25 to +50°C
	N.F.C. 63300		Storage	-30 to +70°C
	CEI EN 60529		IEC 60529	
Impact resistance:	>IK 07 (Die-cast bodies)	Cable entry	See individual product chart	
Glow wire test:	850°C insert	Connecting sections of the wires	See individual product chart	

High current

- Extremely heavy duty die cast metal plugs & connectors with screw ring coupling
- Particularly suited to areas such as shipyards, mines, railways, with applications including high powered cranes & tunnelling machinery
- Designed for use at operating voltages up to 3.3kV, & current ratings up to 800A available
- Female socket contacts are finger proof to IP2X
- Cable termination is made directly to the contact terminals by crimping process. Contacts are manufactured in two halves to allow ease of crimping & cable installation
- Products are offered with optional sizes of crimp terminations allowing the user to match to the installation conductor size
- Spare/replacement crimp terminations are available on request
- Products are equipped with 2 late make, early break pilot contacts rated at 10A, which can be utilised for electrical interlocking circuits
- Appliance inlets can be provided with an anti-contamination cap as an optional extra

HIGH CURRENT PLUGS AND CONNECTORS

IP66 Watertight - plug

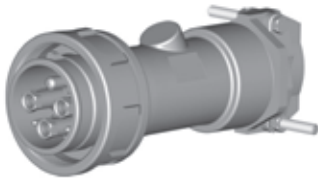

A	MAX. CABLE SIZE mm.			3P+E	4P+E
	MAIN CONTACTS	PILOT CONTACTS	CABLE O.D.		
200	35	6	32-42		PD330/345N
	50	6	32-42		PD330/157N
	70	6	43-54		PD331/328N
250	50	10	32-42	PD330/343N	
	70	10	43-54	PD330/155N	
320	95	6	52-62		PD330/355N
	120	6	52-62		PD330/159N
	150	6	52-62		PD331/270N
400	95	10	45-55	PD330/351N	
	120	10	52-62	PD330/353N	
	150	10	52-62	PD331/269N	

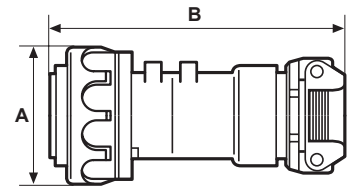

(A)	mm.	
	A	B
200-250	130	282
320-400	155	395

IP66 Watertight - cable connector

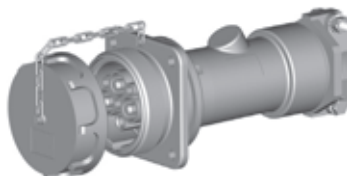

A	MAX. CABLE SIZE mm.			3P+E	4P+E
	MAIN CONTACTS	PILOT CONTACTS	CABLE O.D.		
200	35	6	32-42		PD330/416N
	50	6	32-42		PD330/224N
	70	6	43-54		PD331/330N
250	50	10	32-42	PD330/408N	
	70	10	43-54	PD330/410N	
320	95	6	52-62		PD330/438N
	120	6	52-62		PD330/440N
	150	6	52-62		PD331/276N
400	95	10	45-55	PD330/430N	
	120	10	52-62	PD330/432N	
	150	10	52-62	PD331/275N	

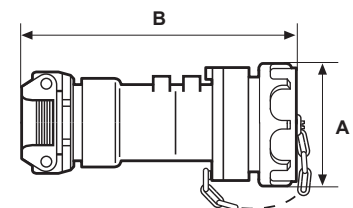



(A)	mm.	
	A	B
200-250	132	305
320-400	155	412

INDUSTRIAL PLUGS & SOCKETS

HIGH CURRENT APPLIANCE INLETS AND SOCKETS

IP66 Watertight - appliance inlet panel mounted - straight



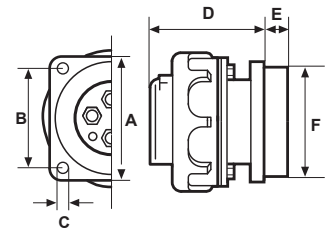

A	MAX. CABLE SIZE mm.		 3P+E	 4P+E
	MAIN CONTACTS	PILOT CONTACTS		
200	35	6		PD330/417N
	50	6		PD330/223N
	70	6		PD331/331N
250	50	10	PD330/409N	
	70	10	PD330/411N	
320	95	6		PD330/439N
	120	6		PD330/441N
	150	6		PD331/279N
400	95	10	PD330/431N	
	120	10	PD330/433N	
	150	10	PD331/278N	

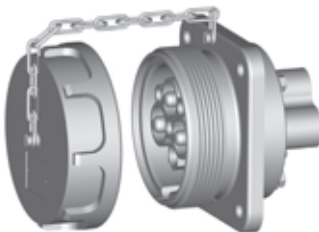

(A)	mm.					
	A	B	C	D	E	F
200-250	116	92	11	107	20	106
320-400	158	120	13	120	20	134

IP66 Watertight - semi recessed socket



A	MAX. CABLE SIZE mm.		 3P+E	 4P+E
	MAIN CONTACTS	PILOT CONTACTS		
200	35	6		PD330/346N
	50	6		PD330/158N
	70	6		PD331/326N
250	50	10	PD330/344N	
	70	10	PD330/156N	
320	95	6		PD330/356N
	120	6		PD330/160N
	150	6		PD331/264N
400	95	10	PD330/352N	
	120	10	PD330/354N	
	150	10	PD331/263N	

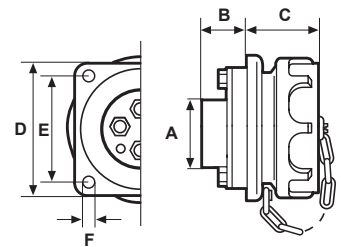

(A)	mm.					
	A	B	C	D	E	F
200-250	106	55	75	116	92	11
320-400	136	60	85	158	120	13

SWITCHED INTERLOCKED SOCKETS



SWITCHED INTERLOCKED SOCKETS

SWITCHED AND MECHANICALLY INTERLOCKED SOCKETS

These products combine a padlockable rotary isolation switch with a receptacle in one compact unit. A mechanical interlock prevents making or breaking of the electrical circuit under load conditions, by not allowing the isolator to be switched on until a mating plug has been fully inserted, nor the plug to be withdrawn until the isolator has been switched off

TAIS SWITCHED INTERLOCKED SOCKETS (page 50)

- A comprehensive switched & mechanically interlocked socket range from 16 to 125A designed for use in the most arduous environmental conditions
- Extremely robust & particularly suited for use in areas such as industrial factories, farms, chemical industries, refrigerating rooms, distilleries, fuel deposits etc
- The flameproof thermosetting material does not burn or cause smoke & does not age
- The material is practically 100% resistant to most aggressive substances such as hydrocarbons, acids, oils etc
- This range of products feature the ability to incorporate an integral circuit protection device such as fuses /MCB/RCD/ RCBO (padlocks not supplied)
- High visibility rotary handle & is padlockable

ALUPRES SWITCHED INTERLOCKED SOCKETS (page 51)

- A comprehensive switched & mechanically interlocked socket range from 16 to 125A designed for use in the most arduous environmental conditions
- Extremely robust die cast aluminium alloy body construction for heavy duty use
- Particularly suitable for use in areas such as mines, quarries, airports, ship yards, foundries, railway depots, & other very demanding working locations
- This range of products feature the ability to incorporate an integral circuit protection device such as fuses /MCB/RCD/ RCBO (not supplied)
- High visibility rotary handle & can be padlocked

SWITCHED INTERLOCKED SOCKETS



SWITCHED SOCKETS

Conformity to Standards:	CEI EN 60309-1	IEC 60309-1	Cable entry	16A	2P+E	min: 8	max: 13	mm
	CEI EN 60309-2	IEC 60309-2		32A	3P+E	min: 8.5	max: 14	mm
	CEI EN 60529	IEC 60529			3P+N+E	min: 10	max: 15.5	mm
Impact resistance:	>IK 08							
Glow wire test:	850°C insert							
Self extinguishing:	V2							
Temperature resistance:	Operating	-25 to +50°C	Connecting sections of the wires	16A		min: 1	max: 2.5	mm ²
	Storage	-30 to +70°C		32A		min: 2.5	max: 6	mm ²

MOULDED IEC 60309 SWITCHED SOCKETS

IP67 Watertight - switched sockets



A	V			
		2P+E	3P+E	3P+N+E
16	110	PM16/3400		
	230	PM16/3401		
	400		PM16/3405	PM16/3408
32	110	PM32/3400		
	230	PM32/3401		
	400		PM32/3405	PM32/3408
63	110	PM63/3400		
	230	PM63/3401		
	400		PM63/3405	PM63/3408
125	400		PM125/3405	PM125/3408

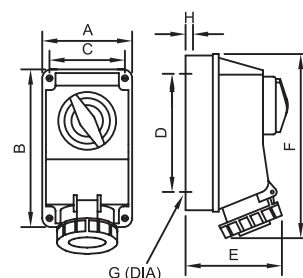



(A)	Poles	mm.							
		A	B	C	D	E	F	G	H
16	2P+E	112	178	92	146	128	195	5.5	6
	3P+E	112	178	92	146	128	195	5.5	6
	3P+N+E	112	178	92	146	128	195	5.5	6
32	2P+E	122	212	101	171	150	232	6.5	6.5
	3P+E	122	212	101	171	152	232	6.5	6.5
	3P+N+E	122	212	101	171	155	232	6.5	6.5
63	2P+E	166	295	135	265	210	330	8	6
	3P+E	166	295	135	265	210	330	8	6
	3P+N+E	166	295	135	265	210	330	8	6

SWITCHED INTERLOCKED SOCKETS

MOULDED IEC 60309 SWITCHED INTERLOCKED SOCKETS

IP44 Splashproof - topTER series



A	V			
16	110	PM16/3300NFPB		
	230	PM16/3301NFPB		
	400		PM16/3305NFPB	PM16/3308NFPB
32	110	PM32/3300NFPB		
	230	PM32/3301NFPB		
	400		PM32/3305NFPB	PM32/3308NFPB

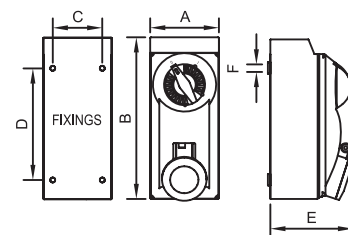

- Padlockable in ON & OFF positions.
- Smooth walls - undrilled (all faces)



(A)	Poles	mm.					
		A	B	C	D	E	F
16	2P+E	108	260	76	170	130	5
	3P+E	108	260	76	170	135	5
	3P+N+E	108	260	76	170	135	5
32	2P+E	108	260	76	170	145	5
	3P+E	108	260	76	170	148	5
	3P+N+E	108	260	76	170	148	5

IP66/67 Watertight - topTER series



A	V			
16	110	PM16/3400NFPB		
	230	PM16/3401NFPB		
	400		PM16/3405NFPB	PM16/3408NFPB
32	230	PM32/3401NFPB		
	400		PM32/3405NFPB	PM32/3408NFPB

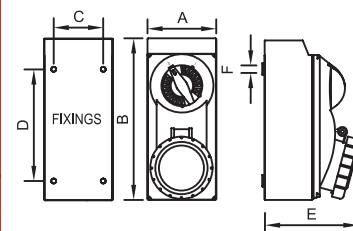

- Padlockable in ON & OFF positions.
- Smooth walls - undrilled (all faces)



(A)	Poles	mm.					
		A	B	C	D	E	F
16	2P+E	108	260	76	170	148	5
	3P+E	108	260	76	170	148	5
	3P+N+E	108	260	76	170	148	5
32	2P+E	108	260	76	170	160	5
	3P+E	108	260	76	170	160	5
	3P+N+E	108	260	76	170	160	5

IP65 Watertight - Ter series



A	V			
63	230	PM63/3401FPB		
	400		PM63/3405FPB	PM63/3408FPB

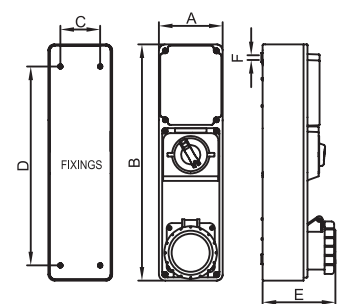

(A)	Poles	mm.					
		A	B	C	D	E	F
63	2P+E	122	452	72	370	135	5
	3P+E	122	452	72	370	135	5
	3P+N+E	122	452	72	370	135	5

SWITCHED INTERLOCKED SOCKETS



PRIMA and topTER valox series

Conformity to Standards:	CEI EN 60309-1	IEC 60309-1	Glow wire test:	960°C switch / 850°C socketinsert
	CEI EN 60309-2	IEC 60309-2	Self extinguishing:	V0/V2
	CEI EN 60309-4	IEC 60309-4	Insulating:	double
	CEI EN 60529	IEC 60529	Beaker category:	AC23A - AC3
	CEI EN 60947-3	IEC 60947-3	Temperature resistance:	Operating -40 to +70°C
Protection rating:	IP66/IP67		Connecting sections of the wires	16-32A min: 1 max: 10
Impact resistance:	>IK 10			

VALOX MOULDED IEC 60309 SWITCHED INTERLOCKED SOCKETS

IP67 Watertight interlocked socket - Prima



A	V	 2P+E	 3P+E	 3P+N+E
16	110	497124	497134	497144
	230	497126	497139	497149
	400	497129	497136	497146
32	110	497224	497234	497244
	230	497226	497239	497249
	400	497229	497236	497246

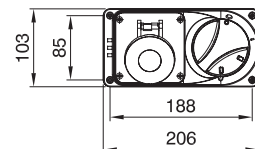

IP67 Watertight wall mounting bottom box



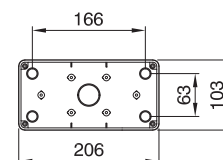

Dimensions mm.	For socket-outlets	CODE
103 x 206	16A-32A watertight horizontal Prima	579700



SWITCHED INTERLOCKED SOCKETS

IP66/67 Watertight interlocked socket - topTER



A	V	 2P+E	 3P+E	 3P+N+E
16	110	891124	891134	891144
	230	891126	891139	891149
	400	891129	891136	891146
32	110	891224	891234	891244
	230	891226	891239	891249
	400	891229	891236	891246

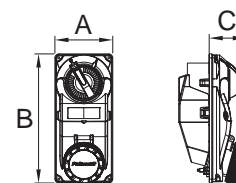

Rated current (A)	Poles	A (mm)	B (mm)	C (mm)
16	2P+E	103	230	66
	3P+E	103	230	69
	3P+N+E	103	230	73
32	2P+E	103	230	81
	3P+E	103	230	81
	3P+N+E	103	230	101

IP66/67 Watertight wall mounting box



Dimensions mm.	For socket-outlets	CODE
108 x 280	16A-32A watertight vertical topTER	579720

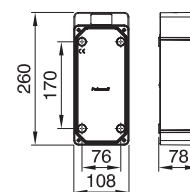

SWITCHED INTERLOCKED SOCKETS



TAIS SERIES

Conformity to Standards:	CEI EN 60309-1	IEC 60309-1	Categoria interruttore:	AC23A
	CEI EN 60309-2	IEC 60309-2	Temperature resistance:	Operating -25 to +50°C
	CEI EN 60529	IEC 60529	Storage	-30 to +80°C
	CEI EN 60947-3	IEC 60947-3	Connecting sections of the wires	16-32A min: 1 max: 10 mm ²
Impact resistance:	>IK 10		63A min: 6 max: 16 mm ²	
Glow wire test:	960°C		125A min: 16 max: 70 mm ²	
Self extinguishing:	V0			

THERMOSETTING (GRP) IEC 60309 SWITCHED SOCKETS

IP67 Watertight - Tais - Thermosetting (GRP)



A	V			
16	230	470126		
	400		470136	470146
32	230	470226		
	400		470236	470247
63	230	470326		
	400		470336	470346

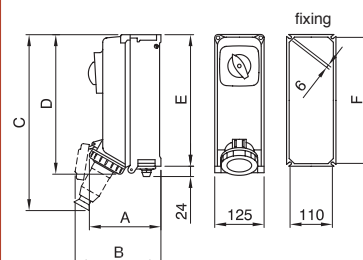

16A & 32A products come with PG29 –M32 thread adaptor & PG29 blanking plugs & locking nuts.
63A products come with PG29 – PG36 blanking plugs & locking nuts.



(A)	Poles	mm.					
		A	B	C	D	E	F
16	2P+E	150	178	390	335	315	300
	3P+E	155	186	400	335	315	300
	3P+N+E	160	195	400	335	315	300
32	2P+E	168	208	420	335	315	300
	3P+E	168	208	420	335	315	300
	3P+N+E	170	210	420	336	315	300
63	ALL	188	250	518	382	355	340

IP67 Watertight - Tais - Thermosetting (GRP)



A	V			
16	110	PMXCD16/400SINFPB		
	230	PMXCD16/401SINFPB		
	400		PMXCD16/405SINFPB	PMXCD16/408SINFPB
32	110	PMXCD32/400SINFPB		
	230	PMXCD32/401SINFPB		
	400		PMXCD32/405SINFPB	PMXCD32/408SINFPB
63	230	PMXCD63/401SINFPB		
	400		PMXCD63/405SINFPB	PMXCD63/408SINFPB

Including din rail & transparent window for installation of a circuit breaker or RCD (up to 4)

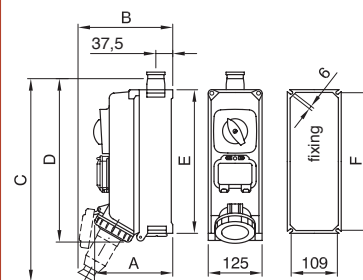

(A)	Poles	mm.					
		A	B	C	D	E	F
16	2P+E	159	183	428	377	335	319
	3P+E	164	191	434	377	335	319
	3P+N+E	175	203	435	380	335	319
32	2P+E	177	213	458	377	335	319
	3P+E	185	218	457	380	335	319
	3P+N+E	203	257	547	423	370	354
63	ALL	188	250	518	382	355	340

SWITCHED INTERLOCKED SOCKETS



ALUPRES SERIES

Conformity to Standards:	CEI EN 60309-1	IEC 60309-1	Categoria interruttore:	AC23A
	CEI EN 60309-2	IEC 60309-2	Temperature resistance:	Operating -25 to +50°C
	CEI EN 60529	IEC 60529	Storage	-50 to +80°C
	CEI EN 60947-3	IEC 60947-3	Connecting sections of the wires	16-32A min: 1 max: 10 mm ²
Impact resistance:	>>IK 10		63A min: 6 max: 16 mm ²	
Glow wire test:	960°C		125A min: 16 max: 70 mm ²	
Self extinguishing:	V0			

ALUMINUM IEC 60309 SWITCHED SOCKETS

IP67 Watertight - Alupres



A	V	 2P+E	 3P+E	 3P+N+E
16	110	PD16/300FPB		
	230	PD16/301FPB		
	400		PD16/305FPB	PD16/311FPB
32	230	PD32/301FPB		
	400		PD32/305FPB	PD32/311FPB
63	400		PD63/305FPB	PD63/311FPB
	400		PD125/305FPB	PD125/311FPB

Supplied with flat undrilled closing flanges top & bottom

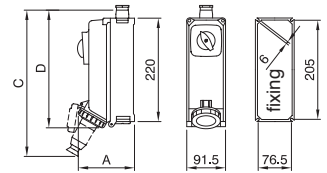

Rated current (A)	Poles	A (mm)	C (mm)	D (mm)
16	2P+E	124	300	250
	3P+E	128	305	250
	3P+N+E	132	315	252

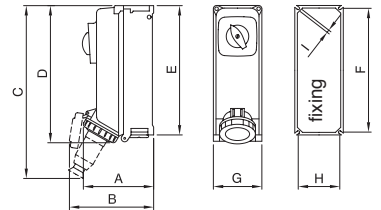

(A)	Poles	mm.								
		A	B	C	D	E	F	G	H	I
32	2P+E	168	208	420	335	315	300	125	110	6
	3P+E	168	208	420	335	315	300	125	110	6
	3P+N+E	170	210	420	336	315	300	125	110	6
63	ALL	188	250	518	382	355	340	125	110	6
125	ALL	240	344	748	545	507	490	185	168	7



RCD SOCKETS

Conformity to Standards:	BS EN 60309-1	IEC 60309-1	Temperature resistance:	Operating	-25 to +50°C	
	BS EN 60309-2	IEC 60309-2		Storage	-30 to +70°C	
	BS EN 60529	IEC 60529		Cable entry	16A-32A	M20 & M32 Threaded entry
	BS EN 61008 RCCE	IEC 60529			63A	M32 Threaded entry
Impact resistance:	>IK 06	16 & 32A - >IK 07 63 & 125A	Connecting sections of the wires	16A	min: 1 max: 4 mm ²	
Glow wire test:	850°C			32A	min: 2.5 max: 10 mm ²	
Breaker category:	30mA (RCCB)			63A	min: 6 max: 25 mm ²	



RCD sockets

A range of switched interlocked socket inlets incorporating a residual current device (supplied) MCBs & RCBOs available on request

MOULDED IEC 60309 RCD SOCKETS

IP44 Splashproof



A	V	 2P+E	 3P+E	 3P+N+E
16	110	PMRCD16/300N ⁽¹⁾		
	230	PMRCD16/301N ⁽¹⁾		
	400		PMRCD16/305C ⁽²⁾	PMRCD16/308C ⁽²⁾
32	110	PMRCD32/300C ⁽¹⁾		
	230	PMRCD32/301C ⁽¹⁾		
	400		PMRCD32/305C ⁽²⁾	PMRCD32/308C ⁽²⁾

⁽¹⁾ Includes 30mA-2 pole RCD AC-CLASS

⁽²⁾ Includes 4 pole RCD

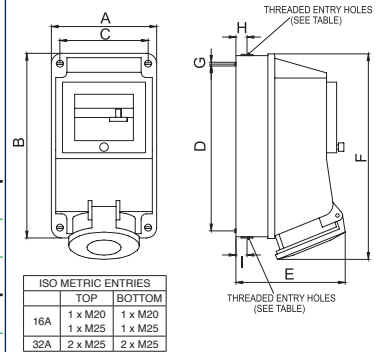

Other mA variants on request



(A)	Poles	mm.								
		A	B	C	D	E	F	G	H	I
16	2P+E	112	183	92	145	128	202	5.5	20	20
	3P+E	112	183	92	145	128	202	5.5	20	20
	3P+N+E	112	183	92	145	128	202	5.5	20	20
32	2P+E	122	212	101	171	151	232	5.5	18	18
	3P+E	122	212	101	171	151	232	5.5	18	18
	3P+N+E	122	212	101	171	151	232	5.5	18	18

IP67 Watertight



A	V	 2P+E	 3P+E	 3P+N+E
16	110	PMRCD16/400C ⁽¹⁾		
	230	PMRCD16/401C ⁽¹⁾		
	400		PMRCD16/405C ⁽²⁾	PMRCD16/408C ⁽²⁾
32	110	PMRCD32/400C ⁽¹⁾		
	230	PMRCD32/401C ⁽¹⁾		
	400		PMRCD32/405C ⁽²⁾	PMRCD32/408C ⁽²⁾
63	230	PMRCD63/401C ⁽¹⁾		
	400		PMRCD63/405C ⁽²⁾	PMRCD63/408C ⁽²⁾

⁽¹⁾ Includes 30mA-2 pole RCD AC-CLASS

⁽²⁾ Includes 4 pole RCD

Other mA variants on request

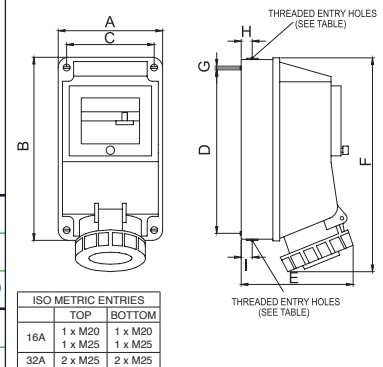

(A)	Poles	mm.								
		A	B	C	D	E	F	G	H	I
16	2P+E	112	183	92	145	128	202	5.5	20	20
	3P+E	112	183	92	145	128	202	5.5	20	20
	3P+N+E	112	183	92	145	128	202	5.5	20	20
32	2P+E	122	212	101	171	151	232	5.5	18	18
	3P+E	122	212	101	171	151	232	5.5	18	18
	3P+N+E	122	212	101	171	151	232	5.5	18	18



topTER

Conformity to Standards:	CEI EN 60309-1	IEC 60309-1	Cable entry	16A	2P+E	min: 8	max: 13 mm
	CEI EN 60309-2	IEC 60309-2		32A	3P+E	min: 8.5	max: 14 mm
	CEI EN 60529	IEC 60529			3P+N+E	min: 10	max: 15.5mm
Impact resistance:	>IK 08						
Glow wire test:	850°C insert						
Self extinguishing:	V2						
Temperature resistance:	Operating	-25 to +50°C	Connecting sections of the wires	16A	2P+E	min: 1	max: 2.5mm ²
	Storage	-30 to +70°C		32A	3P+N+E	min: 2.5	max: 6 mm ²

MOULDED IEC 60309 SWITCHED INTERLOCKED SOCKETS - RCD

IP44 Splashproof - topTER



A	V			
		2P+E	3P+E	3P+N+E
16	110	PMRCD16/300SITT ⁽¹⁾		
	230	PMRCD16/301SITT ⁽¹⁾		
	400		PMRCD16/305SITT ⁽²⁾	PMRCD16/308SITT ⁽²⁾
32	110	PMRCD32/300SITT ⁽¹⁾		
	230	PMRCD32/301SITT ⁽¹⁾		
	400		PMRCD32/305SITT ⁽²⁾	PMRCD32/308SITT ⁽²⁾

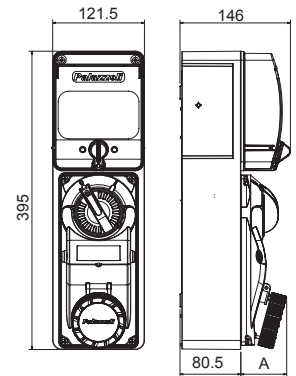

⁽¹⁾ Includes 30mA-2 pole RCD AC-CLASS
⁽²⁾ Includes 4 pole RCD
 Other mA variants on request



Rated current (A)	Poles	A (mm)	B (mm)	C (mm)
16	2P+E	103	230	66
	3P+E	103	230	69
	3P+N+E	103	230	73
32	2P+E	103	230	81
	3P+E	103	230	81
	3P+N+E	103	230	101

IP66 Watertight - topTER



A	V			
		2P+E	3P+E	3P+N+E
16	110	PMRCD16/400SITT ⁽¹⁾		
	230	PMRCD16/401SITT ⁽¹⁾		
	400		PMRCD16/405SITT ⁽²⁾	PMRCD16/408SITT ⁽²⁾
32	110	PMRCD32/400SITT ⁽¹⁾		
	230	PMRCD32/401SITT ⁽¹⁾		
	400		PMRCD32/405SITT ⁽²⁾	PMRCD32/408SITT ⁽²⁾

⁽¹⁾ Includes 30mA-2 pole RCD AC-CLASS
⁽²⁾ Includes 4 pole RCD
 Other mA variants on request

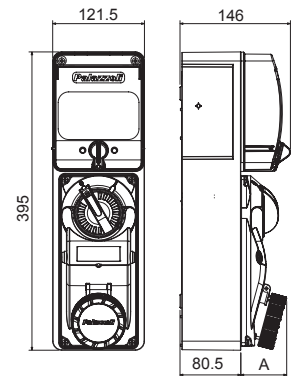

Rated current (A)	Poles	A (mm)	B (mm)	C (mm)
16	2P+E	103	230	66
	3P+E	103	230	69
	3P+N+E	103	230	73
32	2P+E	103	230	81
	3P+E	103	230	81
	3P+N+E	103	230	101



TAIS SERIES

Conformity to Standards:	CEI EN 60309-1	IEC 60309-1	Categoria interruttore:	AC23A	
	CEI EN 60309-2	IEC 60309-2	Temperature resistance:	Operating	-25 to +50°C
	CEI EN 60529	IEC 60529		Storage	-30 to +80°C
	CEI EN 60947-3	IEC 60947-3	Connecting sections of the wires	16-32A	min: 1 max: 10 mm ²
Impact resistance:	>IK 10	63A		min: 6 max: 16 mm ²	
Glow wire test:	960°C	125A		min: 16 max: 70 mm ²	
Self extinguishing:	V0				

MOULDED IEC 60309 SWITCHED INTERLOCKED SOCKETS - RCD

IP67 Watertight - Tais Thermosetting



A	V	 2P+E	 3P+E	 3P+N+E
16	230	PMRCD16/401SINFPB		
	400		PMRCD16/405SINFPB	PMRCD16/408SINFPB
32	230	PMRCD32/401SINFPB		
	400		PMRCD32/405SINFPB	PMRCD32/408SINFPB
63	230	PMRCD63/401SINFPB		
	400		PMRCD63/405SINFPB	PMRCD63/408SINFPB

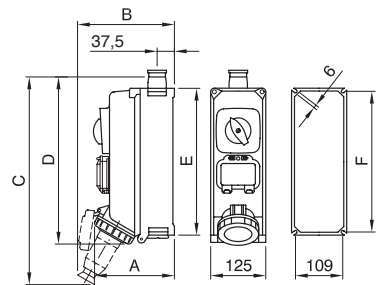

Includes 30mA 2 pole RCD AC-CLASS + 4 Pole
Other mA variants on request
16A & 32A products come with PG29 –M32 thread adaptor & PG29 blanking plugs & locking nuts
63A products come with PG29 – PG36 blanking plugs & locking nuts



(A)	Poles	mm.					
		A	B	C	D	E	F
16	159	183	428	377	335	319	300
	164	191	434	377	335	319	300
	175	203	435	380	335	319	300
32	2P+E	177	213	458	377	335	319
	3P+E	168	208	420	335	315	300
	3P+N+E	185	218	457	380	335	319
63	ALL	203	257	547	423	370	354

IP67 Watertight - Alupres - Metal clad



A	V	 2P+E	 3P+E	 3P+N+E
16	230	472623RCD		
	400		472733RCD	472843RCD
32	230	472624RCD		
	400		472734RCD	472844RCD
63	230	472027RCD		
	400		472137RCD	472647RCD
125	400			MO5023

Alupres switched sockets come with a flat closing flange top & bottom

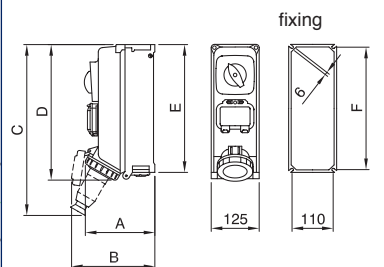

Rated current (A)	Poles	A (mm)	B (mm)	C (mm)	D (mm)	E (mm)	F (mm)
		150	178	390	335	315	300
16	2P+E	150	178	390	335	315	300
	3P+E	155	186	400	335	315	300
	3P+N+E	160	195	400	335	315	300
32	2P+E 3P+E	168	208	420	335	315	300
	3P+N+E	170	210	420	336	315	300
63	ALL	188	250	518	382	355	340

REEFER CONTAINER



REEFER CONTAINER

CONTAINER PRODUCTS

Conformity to Standards:	BS EN 60309-1	IEC 60309-1	Temperature resistance:	Operating	-25 to +50°C
	BS EN 60309-2	IEC 60309-2		Storage	-30 to +70°C
	BS EN 60529	IEC 60529	Cable entry	(Plugs & Connectors) 32A 3P+E	min: 12.5 max: 19.5mm
	EN 60947-3		(Sw. Interlock Skt) 32A 3P+E		M25 Threaded
Impact resistance:	>IK 06		Connecting sections of the wires	32A (Plugs & Connectors)	min: 2.5 max: 6 mm ²
Glow wire test:	850°C			32A Sockets	min: 2.5 max: 10 mm ²

Reefer container

A complete range of watertight (IP67) Plugs & Sockets designed for Container use. Units are in accordance with IEC60309-2, & are rated at 32A.

- A heavy duty product range comprising plugs, connectors, sockets, & switched / mechanically interlocked sockets
- Exclusively designed for reefer container applications
- 32 Amp >380V 50Hz – 440V 60Hz 3 pole + earth (4 pin) rating only
- 3P + Earth with the earth contact in the 3 hour earth clocking position

PLUGS AND CONNECTORS

IP67 Watertight - Cee plug



A	V	
		3P+E
32	>380-400	PM32/605RCFPB

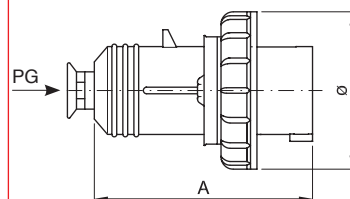

Rated current (A)	Poles	A (mm)	ø (mm)
32	2P+E	141	94
	3P+E	141	94
	3P+N+E	141	101

IP67 Watertight - Cee connector



A	V	
		3P+E
32	>380-400	473486

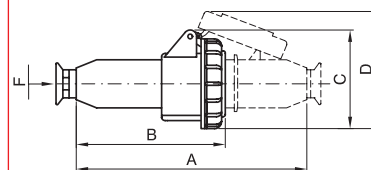

Rated current (A)	Poles	A (mm)	B (mm)	C (mm)	D (mm)
32	2P+E				
	3P+E	328	153	105	125
	3P+N+E			110	130

REEFER CONTAINER

SURFACE, PANEL SOCKETS AND INLETS

IP67 Watertight surface socket



A	V	
32	>380-400	PM32/645/RCPFB

- Smooth walls undrilled
- Cable entry possible on all 4 faces plus rear
- Generous wiring space

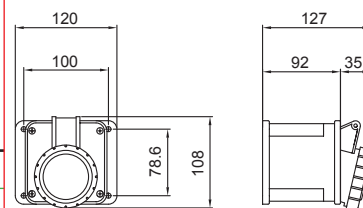

IP67 Watertight topTER panel socket - angled



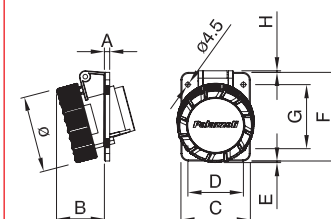

A	V	
32	>380-400	489223

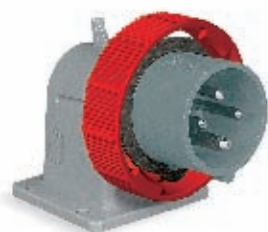

(A)	Poles	mm.						
		A	B	C	D	F	G	ø
16	2P+E	5	45	65	52	60	72	5
	3P+E	5	46	65	52	60	72	80
	3P+N+E	7	47	88	77	100	85	88
32	2P+E	7	54	88	77	100	85	93
	3P+E	7	54	88	77	100	85	93
	3P+N+E	7	55	88	77	100	85	100

IP67 Watertight - Cee appliance inlet



A	V	
32	>380-400	476486

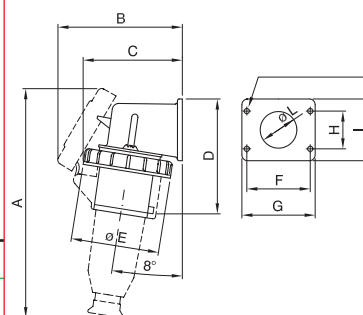

(A)	Poles	mm.									
		A	B	C	D	E	F	G	H	I	L
32	3P+E	248	136	108	125	94	68	80	40	66	40

REEFER CONTAINER

SWITCHED AND INTERLOCKED SOCKETS

IP67 Watertight - switched and interlocked socket



A	V	
32	>380-400	PM32/3405RC

Can be padlocked in on & off positions

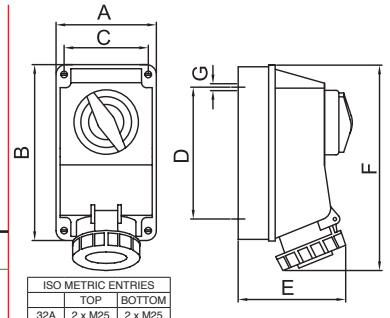

ISO METRIC ENTRIES	
TOP	BOTTOM
32A	2 x M25 2 x M25

(A)	Poles	mm.					
		A	B	C	D	E	F
32	3P+E	122	212	101	171	150	232
						6.5	

IP66/67 Watertight - topTER switched interlocked socket



A	V	
32	>380-400	579710

Can be padlocked in on & off positions

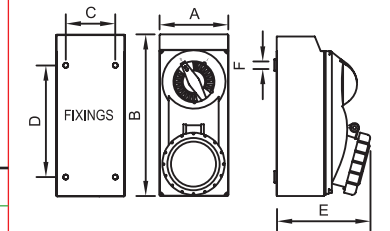

(A)	mm.					
	A	B	C	D	E	F
32	108	260	76	170	148	5

IP67 Watertight - switched and interlocked socket with RCD



A	V	
32	>380-400	PMRCD32/405/SI/RC

Protection at 30mA sensitivity

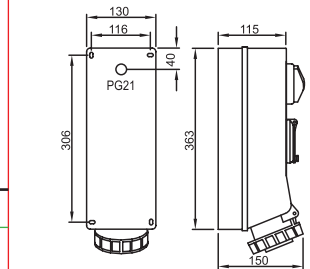

IP67 Watertight - Tais switched and interlocked socket with MCB



A	V	
32	>380-400	474771

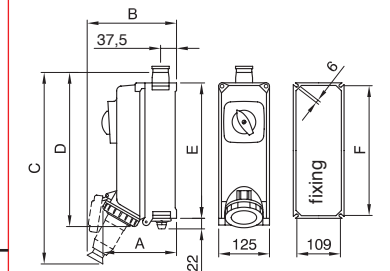

(A)	Poles	mm.					
		A	B	C	D	E	F
32	3P+E	177	213	458	377	335	319

IP67 Watertight - Tais switched and interlocked socket with 4 modules window



A	V	
32	>380-400	472133

- Window allows customer to install their own protective device
- Flying leads from socket & isolation switch to allow ease of installation for protective device

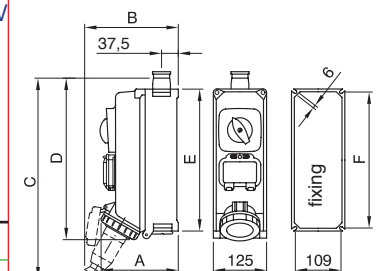

(A)	Poles	mm.					
		A	B	C	D	E	F
32	3P+E	177	213	458	377	335	319

NORTH AMERICAN RANGE



NORTH AMERICAN RANGE

- This comprehensive range of products has been specifically formulated for the North American market
- Products are listed by Underwriters Laboratories UL, approved by the Canadian Standards Authority CSA, & meet the requirements of the National Electrical Code NEC
- The range covers ratings from 20 to 100A & operating voltages up to 600VAC / 250VDC
- These items are not interchangeable with their IEC60309 counterparts

NORTH AMERICAN RANGE

NORTH AMERICAN RANGE							
Conformity to Standards:	CEI EN 60309-1	IEC 60309-1	Cable entry	16A	2P+E	min: 8	max: 13 mm
	CEI EN 60309-2	IEC 60309-2		32A	2P+E	min: 8.5	max: 14 mm
	CEI EN 60529	IEC 60529			3P+N+E	min: 10	max: 15.5mm
Impact resistance:	>IK 08		Connecting sections of the wires	16A	2P+E	min: 11.5	max: 17.5mm
Glow wire test:	850°C insert			32A	3P+E	min: 12.5	max: 19.5mm
Self extinguishing:	V2				3P+N+E	min: 14	max: 21.5mm
Temperature resistance:	Operating	-25 to +50°C		16A		min: 1	max: 2.5mm ²
	Storage	-30 to +70°C		32A		min: 2.5	max: 6 mm ²

IP44 Splashproof



A	V	
60	480	4P-5W PM560P7W

PLUG

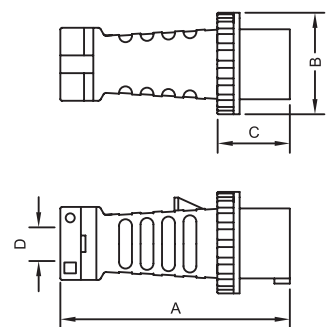

D= MAX CABLE DIAMETER

Rated current (A)	Poles	A (mm)	B (mm)	C (mm)	D (mm)
63	2P+E	238	110	75	31.5
	3P+E	238	110	75	31.5
	3P+N+E	238	110	75	31.5
125	2P+E	315	119	88	45
	3P+E	315	119	88	45
	3P+N+E	315	119	88	45

IP44 Splashproof



A	V	
60	480	4P-5W PM560C7W

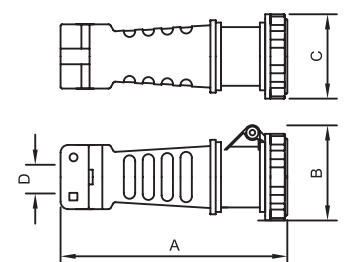

D= MAX CABLE DIAMETER

Rated current (A)	Poles	A (mm)	B (mm)	C (mm)	D (mm)
63	2P+E	255	113	110	31.5
	3P+E	255	113	110	31.5
	3P+N+E	255	113	110	31.5
125	2P+E	350	128	119	45
	3P+E	350	128	119	45
	3P+N+E	350	128	119	45

NORTH AMERICAN RANGE

Also in the range:

Plugs



Connectors



Appliance Inlets

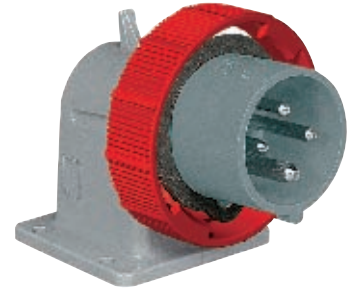

Interlocks



Receptacles



FOR FULL RANGE PLEASE CONTACT LEWDEN SALES

topTER SERIES - THE MODULAR SYSTEM



topTER SERIES - THE MODULAR SYSTEM

- An extremely versatile modular socket distribution board system.
- Offering a vast range of accessories that enables unique modularity of the 16 to 63A system to meet the most diverse power distribution requirements.
- Suitable for single & multi gang socket outlet applications.
- Available with either basic or mechanically switched interlocked socket outlets, or a combination of the two.
- Portable or wall mount applications for both indoor or outdoor use (IP44 / IP67).
- Flush mounting options available (not on full product range).
- Lewden are pleased to offer fully assembled, wired & tested multi-gang / multi-voltage distribution boards (incorporating circuit protection devices) to meet individual client specification requirements, thus enabling rapid site installation.

Contact our custom build division for further details.



ACTIVE PROTECTION

Even in risky environmental situation, topTER's reinforced watertight body protects you from accidental contacts with live parts.



HIGH VISIBILITY

It is the only patented switch that permits remote switch status identification. It can be locked in the "0" and "1" positions.



EASY OPEN

The EasyOpen window makes the opening and the closing easier, even repeatedly. no force is required; the side buttons are designed to make the opening as easy as possible. Fuse boxes are so easy to remove and cartridges can be safely inserted.



IP66/IP67

It is the only dual protection level socket in its class. It guarantees resistance against violent blows (IP66) and is protected against accidental immersions (IP67).



CONTROLLED POWER

The auxiliary contact lets you turn on a remote socket-plug connection signal to monitor energy distribution remotely.



ONE SIZE SEVERAL SOLUTIONS

Thanks to unified dimensions between the interlocked sockets with and without fuse bases, all flanged panels, boxes and accessories are universal.



FUSE GUARD

Fuse operations are continually signalled to even inexperienced users with a hazard light.



MORE SPACE

In addition to easy wiring, the high capacity internal volume of the panels guarantees maximum heat dissipation, avoiding declassing and premature aging.



TAMPER-PROOF

Fuse boxes can be locked with self-threading screws. This tamper-proof system prevents theft, thus avoiding costly disservices.



AUTO FUSE LOCK

Closing the cover automatically guides fuse boxes into closed and secure contact position, thus guaranteeing protection against inept contact over currents, power surges and overheating. Boxes are captive, fully removable and guarantee IP20 even during fuse removal and insertion operations.



A32 INSIDE

AC23A-AC3 work class, 10,000A conditional short circuit current and guaranteed cut-off. It eliminates machine downtime probabilities.



DOMO TER DOMESTIC PROTECTION

FUNCTIONAL VERSATILITY

The multi-function devices allow for a very varied range of configurations, providing solutions to many installation requirements. Single pole, double pole and two way switches, and push buttons, combine to give versatility, but also economy of stock.



MULTI-PURPOSE

The domoTER devices can be installed in wall-mounting watertight and protected enclosures, and can also be panel mounted on DIN rail supports.



MAXIMUM MODULAR VERSATILITY

domoTER can be integrated into the topTER, PRIMA and TER series boards, and they can be used in multi-functional boards, together with other sockets and devices, to supply electrical equipment that has either a domestic or industrial plug.



topTER SERIES - THE MODULAR SYSTEM

MODULAR SYSTEM COMBINATIONS

INTERLOCKED SOCKETS AND SCHUKO



ENCLOSURES AND BOARDS



SOCKETS



topTER SERIES - THE MODULAR SYSTEM



topTER

Conformity to Standards:	CEI EN 60309-1	IEC 60309-1	Cable entry	16A	2P+E	min: 8	max: 13 mm
	CEI EN 60309-2	IEC 60309-2		32A	3P+E	min: 8.5	max: 14 mm
	CEI EN 60529	IEC 60529			3P+N+E	min: 10	max: 15.5mm
Impact resistance:	>IK 08						
Glow wire test:	850°C insert						
Self extinguishing:	V2						
Temperature resistance:	Operating	-25 to +50°C	Connecting sections of the wires	16A		min: 1	max: 2.5mm ²
	Storage	-30 to +70°C		32A		min: 2.5	max: 6 mm ²

16A AND 32A - INTERLOCKED SOCKET-OUTLETS

IP44 Splashproof interlocked socket-outlets



A	V	 2P+E	 3P+E	 3P+N+E
16	110	492124		
	230	492126		
	400		492136	492146
32	110	492224		
	230	492226		
	400		492236	492246

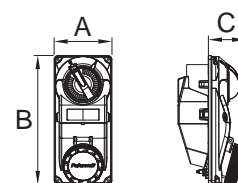

Characteristics: lockable knob in open or closed position, with max ø 3mm padlock.
Can be fitted with 2x auxiliary contacts signalling the insertion of a plug (code 579850)



Rated current (A)	Poles	A (mm)	B (mm)	C (mm)
16	2P+E	103	230	66
	3P+E	103	230	69
	3P+N+E	103	230	73
32	2P+E	103	230	81
	3P+E	103	230	81
	3P+N+E	103	230	101

IP66/IP67 Watertight interlocked socket-outlets



A	V	 2P+E	 3P+E	 3P+N+E
16	110	491124	491134	491144
	230	491126	491139	491149
	400	491129	491136	491146
32	110	491224	491234	491244
	230	491226	491239	491249
	400	491229	491236	491246
	380-440		491233	

Characteristics: fuseholder base 10.3x38 cylindrical, fuses not supplied.
Lockable knob in open or closed position, with max ø 3mm padlock.
Fuse box cover set for tamper-proof screws.
Can be fitted with 2x auxiliary contacts signalling the insertion of a plug (code 579850).

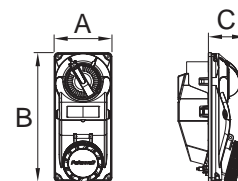

Rated current (A)	Poles	A (mm)	B (mm)	C (mm)
16	2P+E	103	230	66
	3P+E	103	230	69
	3P+N+E	103	230	73
32	2P+E	103	230	81
	3P+E	103	230	81
	3P+N+E	103	230	101

topTER SERIES - THE MODULAR SYSTEM

IP66/IP67 Watertight socket-outlets with safety transformer (selv)



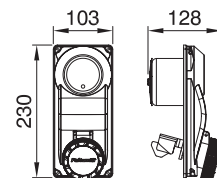

A	V	Transformer	 2P+E
16	230-24	150VA	490024

Characteristics: transformer with built-in thermal protection, enabled by a plug-activated bipolar microswitch to prevent drain on the power source when the socket is not in use.



IP66/IP67 Watertight interlocked socket-outlets with fuseholder base



A	V	 2P+E	 3P+E	 3P+N+E
16	110	490124	490134	490144
	230	490126	490139	490149
	400	490129	490136	490146
32	110	490224	490234	490244
	230	490226	490239	490249
	400	490229	490236	490246

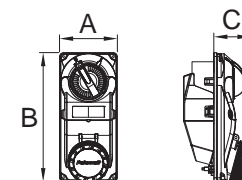

Characteristics: fuseholder base 10.3 x 38 cylindrical, fuses not supplied. Lockable knob in open or closed position, with max ø 3mm padlock. Fuseholder cover set for tamper-proof screws.



Rated current (A)	Poles	A (mm)	B (mm)	C (mm)
16	2P+E	103	230	66
	3P+E	103	230	69
	3P+N+E	103	230	73
32	2P+E	103	230	81
	3P+E	103	230	81
	3P+N+E	103	230	101

IP66/IP67 Watertight interlocked socket-outlets with LED indicator fuseholder base



A	V	 2P+E	 3P+E	 3P+N+E
16	230	499126		
	400		499136	499146
32	230	499226		
	400		499236	499246

Characteristics: fuseholder base 10.3 x 38 cylindrical, fuses not supplied. Lockable knob in open or closed position, with max ø 3mm padlock. Fuse power LED indicator. Fuseholder cover set for tamper-proof screws. Settings for No. 2 auxiliary contacts signalling the inserted plug.

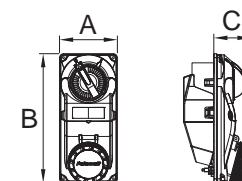

Rated current (A)	Poles	A (mm)	B (mm)	C (mm)
16	2P+E	103	230	66
	3P+E	103	230	69
	3P+N+E	103	230	73
32	2P+E	103	230	81
	3P+E	103	230	81
	3P+N+E	103	230	101

topTER SERIES - THE MODULAR SYSTEM

BOXES AND BOARDS FOR 16A & 32A SOCKETS

IP66/IP67 Watertight wall-mounting bottom box



Dimensions mm.	For socket-outlets	CODE
108 x 260	topTER interlocked socket-outlets	579710

Equipment: bag of screwcaps.

Characteristics: smooth walls with indication of pre-holes.

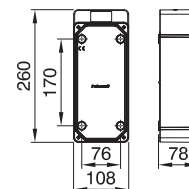

IP55 Watertight flush-mounting bottom box



Dimensions mm.	For socket-outlets	CODE
131 x 258	topTER interlocked socket-outlets	579712

Characteristics: they are perfectly symmetrical and can be installed either way up.

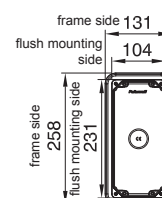

IP66/IP67 Watertight panel-mounting bottom box



Dimensions mm.	For socket-outlets	CODE
115 x 270	topTER interlocked socket-outlets	579711

Equipment: bag of screwcaps.

Uses: it can be mounted in panels made of sheet metal, wood, plaster-board or insulating material.

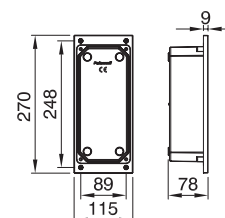

IP66 Watertight high capacity boards with transparent window for interlocked socket-outlets wall installations



Dimensions mm.	No. of installable interlocked socket-outlets	No. of Modules EN50022	Dispersable power (W)	CODE
122 x 395	1	5	22	579741
239 x 456	2	10	40	579742
350 x 456	3	16	56	579743
461 x 456	4	22	70	579744

Equipment: DIN rail kit with adjustable supports. Wire clamps.

Dual insulation screw caps. Hinge kit for module screen door opening.

No. 1 closing flange for boards 579743 and 579744.

Characteristics: pad-lockable modular window. Settings for horizontal and vertical flanking. Temporary mount settings.



topTER SERIES - THE MODULAR SYSTEM

16A & 32A SOCKETS

IP66 Watertight compact blind boards for interlocked socket outlets wall installation



Dimensions mm.	No. of installable interlocked socket-outlets	Dispersable power (W)	CODE
122 x 395	1	22	579721
250 x 395	2	40	579722
380 x 395	3	56	579723



IP55 Watertight covers for EN50022 din rail smoked transparent window and accessories for topTER blind watertight boards



No. of Modules EN50022	For distribution boards	CODE
5	579721	579421
12	579722	579452
18	579723	579453

IP66/IP67 Watertight closing flange for interlocked socket-outlet boards



Dimensions mm.	CODE
103 x 230	579713

Equipment: bag of 4 stainless steel screws for fastening to distribution board.

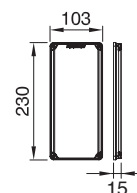

IP66/IP67 Watertight flange for mounting two fixed industrial socket IP44, IP67 and flanges for domestic sockets



Dimensions mm.	CODE
103 x 230	579714

Equipment: No. 1 finishing frame for 65 x 83mm compact socket mounting, No. 1 65 x 83 mm blind flange.

Characteristics: No. 1 fixed hole 65 x 83mm + No. 1 variable hole 65 x 83mm / 88 x 100mm.

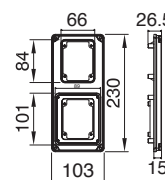

Can fit 2 x 16A sockets or 1x 16A + 1x 32A socket (refer to pages 74-77-78)



63A INTERLOCKED SOCKET-OUTLETS

IP65 Watertight interlocked socket-outlets for board installations



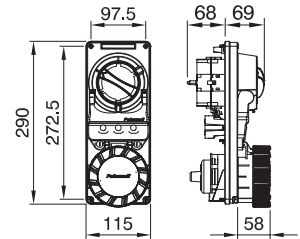

A	V	 2P+E	 3P+E	 3P+N+E
63	110	481324	481334	481344
	230	481326	481339	481349
	400	481329	481336	481346

Equipment: 6 steel screws for board or box mounting.
Characteristics: switch terminals can be screwed in with electric screwdrivers. No auxiliary contacts and fuse guard system.



IP65 Watertight interlocked socket-outlets with fuseholder base for board installations



A	V	 2P+E	 3P+E	 3P+N+E
63	110	480324	480334	480344
	230	480326	480339	480349
	400	480329	480336	480346

Equipment: 6 steel screws for board or box mounting.
Characteristics: switch terminals can be screwed in with electric screwdrivers. D02 type fuses not supplied. No auxiliary contacts and fuse guard system.

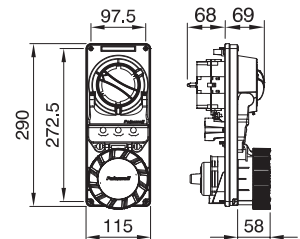

topTER SERIES - THE MODULAR SYSTEM

BOXES AND BOARDS FOR 63A INTERLOCKED SOCKETS

IP55 Watertight wall bottom box



Dimensions mm.	For socket-outlets	CODE
115 x 290	TER interlocked socket-outlets 63A	579400

Equipment: bag of screwcaps.

Characteristics: smooth walls with indication of pre-holes.

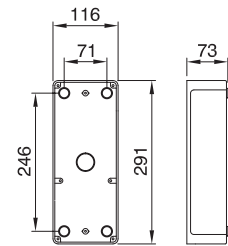

IP65 Watertight blind watertight boards for 63A interlocked socket-outlet installation



Dimensions mm.	No. of installable socket-outlets	Dispersable power (W)	CODE
122 x 452	1	22	579421

Characteristics: smooth walls with indication of pre-holes.

- Provides additional wiring space for incoming supply cables

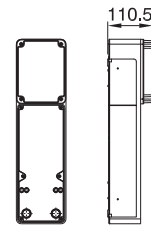

IP65 Watertight high capacity watertight boards with transparent window for 63A interlocked socket-outlets wall installations



Dimensions mm.	No. of installable socket-outlets	No. of Modules EN50022	Dispersable power (W)	CODE
122 x 452	1	5	22	579631

Characteristics: smooth walls with indication of pre-holes.

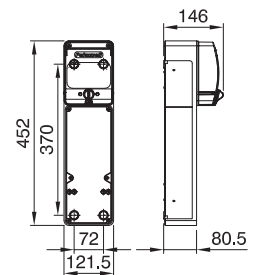



topTER SERIES - THE MODULAR SYSTEM

16A & 32A FIXED SOCKET-OUTLETS

IP44 Splashproof protected angled fixed socket-outlets for board installations



A	V	Dimensions mm.	 2P+E	 3P+E	Dimensions mm.	 3P+N+E
16	110	65 x 83	488124	488134	88 x 100	488144
	230	65 x 83	488126	488139	88 x 100	488149
	400	65 x 83	488129	488136	88 x 100	488146
32	110	88 x 100	488224	488234	88 x 100	488244
	230	88 x 100	488226	488239	88 x 100	488249
	400	88 x 100	488229	488236	88 x 100	488246

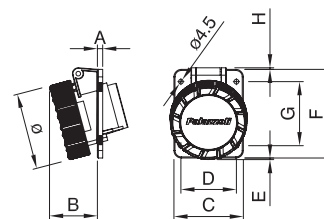

Characteristics: can be fitted with 1x auxiliary contact (product code 579855 – page 76) signalling the insertion of a plug



(A)	Poles	mm.						
		A	B	C	D	F	G	ø
16	2P+E	5	45	65	52	60	72	5
	3P+E	5	46	65	52	60	72	80
	3P+N+E	7	47	88	77	100	85	88
32	2P+E	7	54	88	77	100	85	93
	3P+E	7	54	88	77	100	85	93
	3P+N+E	7	55	88	77	100	85	100

IP66/IP67 Watertight angled fixed socket-outlets for board installations



A	V	Dimensions mm.	 2P+E	 3P+E	Dimensions mm.	 3P+N+E
16	110	65 x 83	489124	489134	88 x 100	489144
	230	65 x 83	489126	489139	88 x 100	489149
	400	65 x 83	489129	489136	88 x 100	489146
32	110	88 x 100	489224	489234	88 x 100	489244
	230	88 x 100	489226	489239	88 x 100	489249
	400	88 x 100	489229	489236	88 x 100	489246
	380-440	88 x 100		489233		

Characteristics: can be fitted with 1x auxiliary contact (product code 579855 – page 76) signalling the insertion of a plug

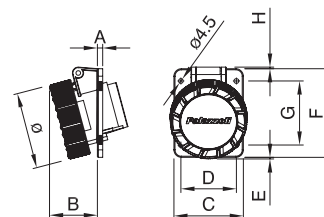

(A)	Poles	mm.						
		A	B	C	D	F	G	ø
16	2P+E	5	45	65	52	60	72	5
	3P+E	5	46	65	52	60	72	80
	3P+N+E	7	47	88	77	100	85	88
32	2P+E	7	54	88	77	100	85	93
	3P+E	7	54	88	77	100	85	93
	3P+N+E	7	55	88	77	100	85	100

IP44 Splashproof protected angled fixed socket-outlets for board installations



COMPACT BOARD SOCKET-OUTLETS

A	V	Flange dimensions mm.	 2P+E
16	110	60 x 60	488114
	230	60 x 60	488116

topTER SERIES - THE MODULAR SYSTEM

16 & 32A BOXES AND BOARDS

IP66 Watertight high capacity boards with transparent window for fixed socket-outlet wall installations



Dimensions mm.	No. of installable 16 or 32A socket-outlets	No. of Modules EN50022	Dispersable power (W)	CODE
239 x 456 x 148	4	10	40	579824
350 x 456 x 148	6	16	56	579826
461 x 456 x 148	8	22	70	579828

Equipment: DIN rail kit with adjustable supports. Wire clamps. Dual insulation screw caps. Hinge kit for door opening. Module screens. No. 2 closing flanges (code 579824 with No. 1 flange). 65 x 83mm finishing frames for fixed socket-outlet mounting in the same number of the board sockets.

Characteristics: pad-lockable modular door. Settings for horizontal and vertical flanking. Temporary mount settings.



IP66/IP67 Watertight closing flange for fixed socket-outlet boards



Dimensions mm.	CODE
88 x 100	579842

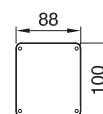

IP55 Watertight standard italian/german dual and fixed domestic socket in watertight cap



A	V	Dimensions mm.	Pins	Pin distance	Type	 2P+E
10/16	230	65 x 83	0.4/4.8	19	P30/P17	579840

topTER SERIES - THE MODULAR SYSTEM

ADDITIONAL ACCESSORIES

Set of 50 tamper-proof screws suitable for installations on fuseholder base protection covers refer to page 69



For sockets	CODE
Socket-outlets with topTER fuseholder base	579855

Auxiliary contact NO and NC signalling the inserted plug 1x changeover contact

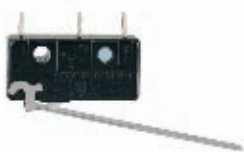

For sockets	CODE
topTER industrial and interlocked sockets	579850

Notes: topTER interlocked socket-outlets set for No. 2 auxiliary contacts. **Equipment:** adaptor for mounting onto fixed socket-outlets. Can be fitted to fixed & interlocked sockets (16A & 32A) - (pages 68-69-74) to provide a volt free signal output when a plug is inserted

Coupling fitting with PG pitch thread for topTER flanged boards series



PG	Assembly hole (mm)	For wires ϕ (mm)	CODE
21	29	17	580250

Through connection of wiring between close allows coupled topTER boards allows boards to be coupled side by side

Equipotential bars for earth connections



No. of holes	Type of connection	CODE
4	M5 screws for wire end up to 25 mm ²	579012
10	M5 screws for wire end up to 25 mm ²	579013

Equipment: connection screws and fastening supports

Pair of stainless steel junction plates for flanged watertight boards



For distribution boards	CODE
For all topTER series boards	579012 Pack of 2

Allows coupled topTER boards allows boards to be coupled side by side

topTER SERIES - THE MODULAR SYSTEM

Transport handle for flanged watertight boards



For distribution boards	CODE
579742, 579743, 579744 579824, 579826, 579828	579011

Universal support for topTER flanged watertight boards



For distribution boards	CODE
For all topTER series boards	570010

Manufactured from stainless steel

IP54 Splashproof schuko recessed domestic socket-outlet

COMPACT SCHUKO SOCKET FOR EXPORT MARKETS



A	V	Standard	Nation	Flange dimensions mm.	 2P+E
13	250	BS1363	UK	50 x 50	579831
16		DIN49440	D	50 x 50	579845
16		DIN49440	IT/PL/HU	50 x 50	579830
16		CEE 7/V	F/B/CZ	50 x 50	579832

IP54 Splashproof Perforated flange set for one recessed socket-outlet installation with 50 x 50 mm flange



Flange dimensions (mm.)	Installable socket-outlet	Distance between assembly holes (mm.)	CODE
88 x 100	579845	38 x 38	579844

Equipment: bag with 4 stainless steel screws for schuko socket assembly on flange.

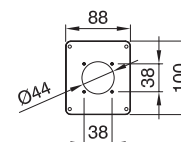

topTER SERIES - THE MODULAR SYSTEM

IP55 Watertight cap mounted on flange for domestic appliance boards installation



Flange dimensions (mm.)	No. of modules	CODE
65 x 83	2	579847

Socket inserts for snap fitting into domoter cover type 579847

Standard Italian/German 250V UNEL domestic socket-outlet



A	V	No. of modules	Pin distance	Type	 2P+E
16	250	2	26	P30	630051

Characteristics: pins with protective screens.

Standard 250V Italian/German RED safety UNEL domestic socket-outlet



A	V	No. of modules	Pin distance	Type	 2P+E
16	250	2	26	P30	630053

Characteristics: pins with protective screens.

topTER SERIES - THE MODULAR SYSTEM

Standard British socket-outlet



A	V	No. of modules	 2P+E
13	250	2	630056

Standard French socket-outlet



A	V	No. of modules	 2P+E
16	250	2	630055

Standard Israeli socket-outlet



A	V	No. of modules	 2P+E
16	250	2	630057

Rj45 class 5E socket-outlet with 8 UTB contacts



Description	No. of modules	CODE
Rj45 class 5E	1	630081

Characteristics: incision terminals, bayonet contacts. Unshielded.

Rj12 socket-outlet No. 6/6 contacts



Description	No. of modules	CODE
Rj12	1	630080

Characteristics: incision terminals, bayonet contacts. Unshielded.

topTER SERIES - THE MODULAR SYSTEM

Multi-functional device, single or double pole switch, Single pole two-way switch, NO/NC switch 16A 250V



Functions	No. of modules	CODE
single or double pole switch; single or double pole NO push-button; single pole two-way switch; single pole NC push-button	1	630030

Complementary items: signalling lamp code 630091.

Line reversing switch 16A 250V



Number	No. of modules	CODE
1	1	630031

Signalling lamp 230V – 50-60 Hz



Colour signalling lamp	No. of modules	CODE
White	1	630040
Red	1	630041
Green	1	630042

Characteristics: products complete with lamps.

1P fuse holder base for 5x10 mm fuses 16A max – 250V



Fuses type	No. of modules	CODE
5 x 10 mm.	1	630035

One module Blank cap



Description	No. of modules	CODE
Module cap	1	630090

topTER SERIES - THE MODULAR SYSTEM

1 module cradle support for DIN rail installation



Fixing	Colour	No. of modules	CODE
on DIN rail EN 50022	grey RAL 7035	1	630021

Characteristics: it takes 1,5 DIN modules.

2 module cradle support for DIN rail installation



Fixing	Colour	No. of modules	CODE
on DIN rail EN 50022	grey RAL 7035	1	630022

Characteristics: it takes 3 DIN modules.

IP40 Wall-mounting protected enclosures for modular devices



Dimensions (mm.)	Colour	No. of modules	CODE
76 x 82 x 58	grey RAL 7035	1	630001
98 x 82 x 58	grey RAL 7035	2	630002
120 x 82 x 58	grey RAL 7035	3	630003

IP55 Watertight Wall-mounting watertight enclosures for modular devices



Dimensions (mm.)	Colour	No. of modules	CODE
76 x 82 x 65	grey RAL 7035	1	630011
98 x 82 x 65	grey RAL 7035	2	630012
120 x 82 x 65	grey RAL 7035	3	630013

WEATHERTIGHT METAL CLAD RANGE



WEATHERTIGHT METAL CLAD RANGE

When the going gets tough choose... Weathertight
Designed & manufactured to withstand the most arduous conditions, & endure long operational life.

METAL WEATHERTIGHT RANGE

- A selection of metal clad plugs & socket outlets ranging from 5 to 30A ratings
- Suitable for operating voltages up to 415VAC
- Heavy duty die cast mazak construction offered in either painted or self colour finishes, & suitable for use in arduous environmental conditions
- Varying product designs in compliance with either BS1363, BS546, or Walsall type A & B pin configurations
- IP66 ingress protection rating
- Designed primarily for installation with metal conduit systems

WEATHERTIGHT METAL CLAD RANGE

TEMPLATE OF GAUGES

These drawings are a 1:1 scale representation of the contact positions & layout for each gauge type

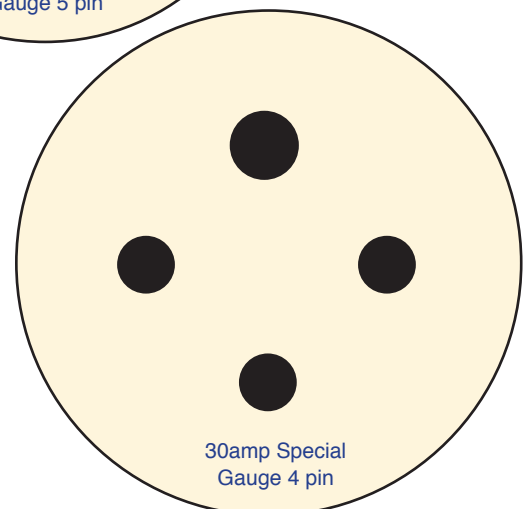
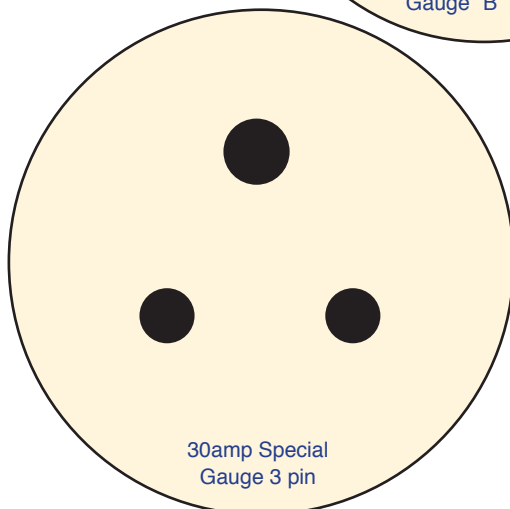
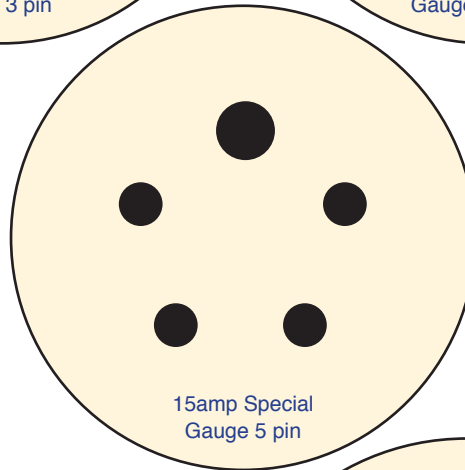
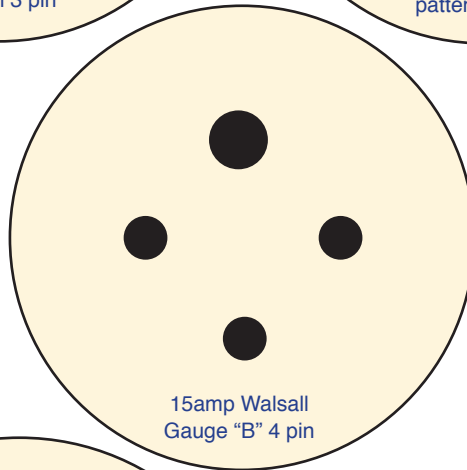
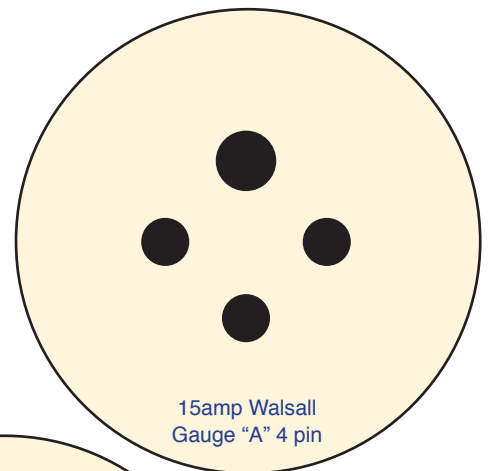
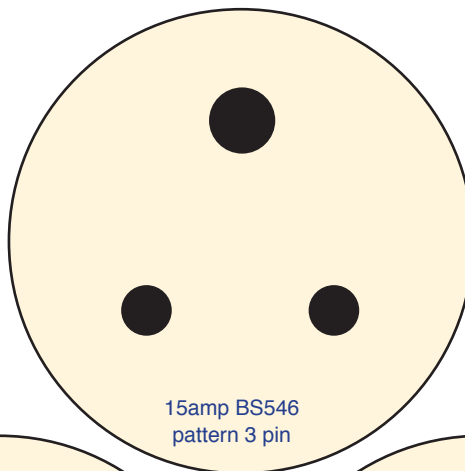
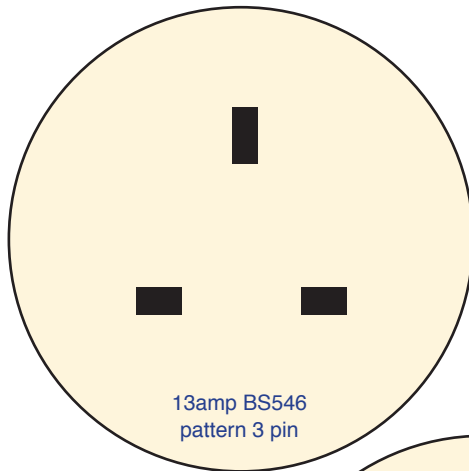
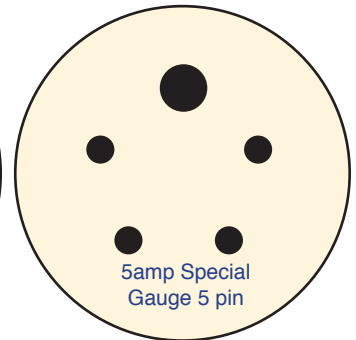
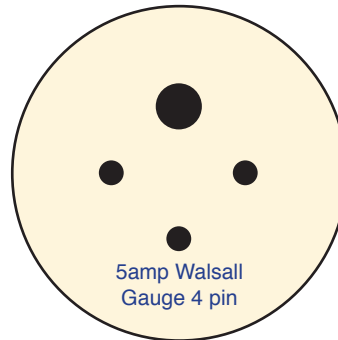
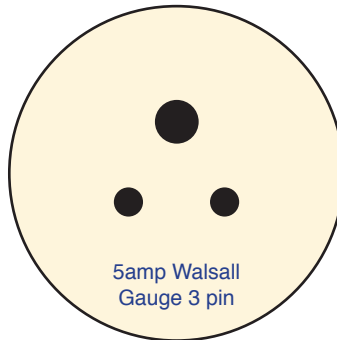
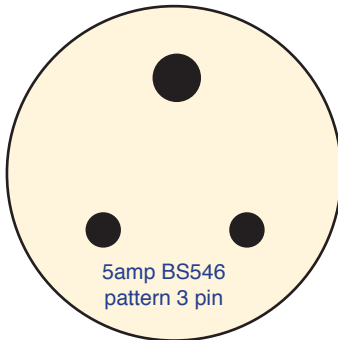

WEATHERTIGHT METAL CLAD RANGE

13A PLUGS & SOCKETS

Conformity to Standards:	BS 1363	BS1362 (FUSE)	Temperature resistance:	Operating	-25 to +50°C
	IEC 60947-3			Storage	-30 to +70°C
Plug and sockets:	BS EN 60529	IEC 60529	Cable entry	Plug and Switch & Socket: M25 Threaded entry	
	BSI - Lic. No. KM 38043; Mod. Doc. 1097			Socket: M20 Threaded entry	
Impact resistance:	>IK 06 (see note)		Connecting sections of the wires	Plug:	min: 0.5 max: 1.5mm ²
Glow wire test:	850°C insert			Socket:	up to 3x2.5mm ² stranded/solid or 2x4mm ² stranded
Breaker category:	AC21A/AC22A				

METAL/MOULDED - 13A BS1363 PLUGS

IP66 Watertight plug - Cable entry - angled



A	TYPE	FINISH	GAUGE	 1P+N+E
13	Plug	Painted metallic	BS1363	PD1327PN

This product incorporates a metal body shell with a plastic moulded locking ring & cable gland

 Approved by BSI
Licence No. KM: 38043
Pending

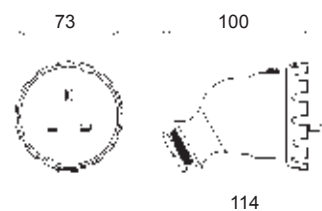

ALL METAL CONSTRUCTION - 13A BS1363 PLUGS

IP66 Watertight plug - Cable entry - angled



A	TYPE	FINISH	GAUGE	 1P+N+E
13	Plug	Painted metallic	BS1363	PD1327PAM

This product is of all metal construction, including the locking ring & cable gland

 Approved by BSI
Licence No. KM: 38043
Pending

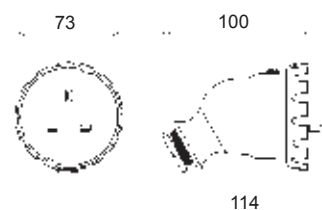

WEATHERTIGHT METAL CLAD RANGE

METAL - 13A BS1363 SOCKETS AND SWITCHED SOCKETS

IP66 Watertight - Round surface socket terminal/through



Metal body with a plastic moulded socket cap & cable entry and blanking plug

A	TYPE	FINISH	GAUGE	 1P+N+E
13	Socket	Painted metallic	BS1363	PD1322SN

All metal construction including socket cap and cable entry blanking plug

A	TYPE	FINISH	GAUGE	 1P+N+E
13	Socket	Painted metallic	BS1363	PD1322SAM

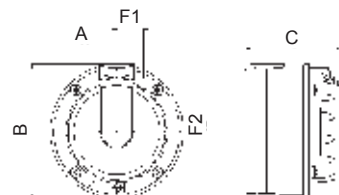

IP66 Watertight – Square surface socket terminal/through



All metal construction

A	TYPE	FINISH	GAUGE	 1P+N+E
13	Socket	Painted metallic	BS1363	PDSQ1322SAM

Surface mounted box can be installed vertically or horizontally

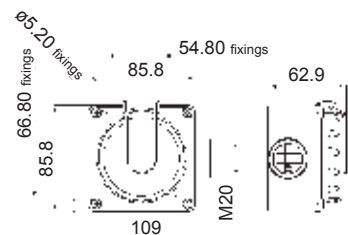

IP66 Watertight - Switch and socket outlet



Metal body with a plastic moulded socket cap, switch handle & cable entry blanking plug

A	TYPE	FINISH	GAUGE	 1P+N+E
13	Switch & Socket	Painted metallic	BS1363	PD1327N

Surface mounted box can be installed vertically or horizontally

All metal construction including socket cap, switch handle & cable entry blanking plug

A	TYPE	FINISH	GAUGE	 1P+N+E
13	Switch & Socket	Painted metallic	BS1363	PD1327SAM

Switch type - 2 pole supplied unwired between switch & socket
Switch handle arranged to mechanically prevent the plug from being inserted or withdrawn in the 'on' position
All products feature a bayonet style socket cap with 180° opening
Switch knob can be padlocked

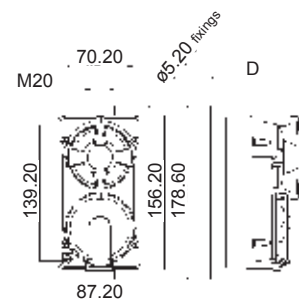

Approved by BSI
Licence No. KM: 38043
Pending

WEATHERTIGHT METAL CLAD RANGE

ROUND PIN PLUGS & SOCKETS

Conformity to Standards:	BS546 / Walsall / Special	IEC 60529	Temperature resistance:	Operating	-25 to +50°C
	BS EN 60529		Storage	-30 to +70°C	
	BS EN 60947-3 (15A)				
Protection Rating:	IP66		Cable entry	5A Plug:	M20 Threaded entry
Impact resistance:	>IK 06			15 & 30A Plugs & Switch Sockets:	M25 Threaded entry
Glow wire test:	850°C insert		Connecting sections of the wires	Unswitched Sockets:	M20 Threaded entry
Breaker category:	AC21A/AC22A			5A & 15A:	max: 4mm ²
				30A:	max: 6mm ²

IP66 Watertight round surface socket terminal/ through & plugs to suit



All metal construction

A	SOCKET ARR.	GAUGE	PLUG	SOCKET
5	2P+E	BS546	PD213/3PAM	PD213/3SAM
	2P+E	Walsall	PD84/3PAM	PD84/3SAM
	3P+E	Walsall	PD84/4PAM	PD84/4SAM
	3P+N+E	Special	PD84/5PAM	PD84/5SAM

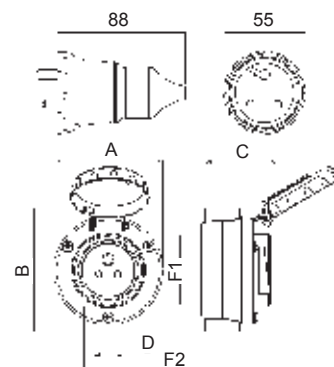

A	SOCKET ARR.	GAUGE	PLUG	SOCKET
15	2P+E	BS546	PD160/3PAM	PD160/3SAM
	3P+E	Walsall B	PD160/4BPAM	PD160/4BSAM
	3P+N+E	Special	PD160/5PAM	PD160/5SAM

(A)	mm.				
	A	B	C	F1	F2
5	77	87.5	55	34	24.5
15	95	95	68	70	16.5
30	95	95	76.5	70	16.5



A	SOCKET ARR.	GAUGE	PLUG	SOCKET
30	2P+E	Special	PD930/3PAM	PD930/3SAM
	3P+E	Special	PD930/4PAM	PD930/4SAM

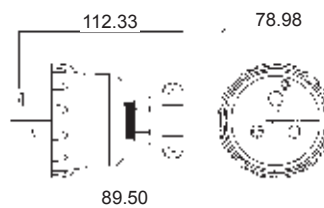

IP66 Watertight square surface socket terminal/ through & plug to suit



A	SOCKET ARR.	GAUGE	PLUG	SOCKET
15	2P+E	BS546	PDSQ160/3PAM	PDSQ160/3SAM

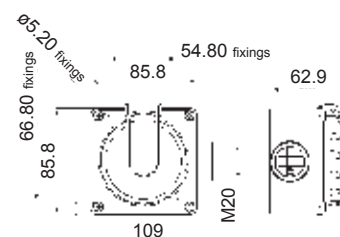

WEATHERTIGHT METAL CLAD RANGE

METAL - ROUND PIN SWITCH SOCKETS

IP66 Watertight switch and socket



Metal body with moulded socket cap, switch handle & cable entry blanking plug

A	SOCKET ARR.	GAUGE	PLUG	SOCKET
15	2P+E	BS546	PD230PN	PD230SN

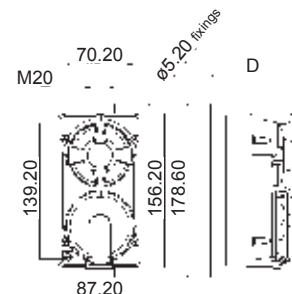

IP66 Watertight switch and socket outlet



All metal construction, including socket cap, switch handle & cable entry blanking plug

A	SOCKET ARR.	GAUGE	PLUG	SOCKET
15	2P+E	BS546	PD230PAM	PD230SAM
	3P+E	Walsall B	PD998BPAM	PD998HBSAM
	3P+N+E	Special	PD999PAM	PD999SAM

A	SOCKET ARR.	GAUGE	PLUG	SOCKET
30	2P+E	Special	PD30/3PAM	PD30/3SAM
	3P+E	Special	PD30/4PAM	PD30/4SAM

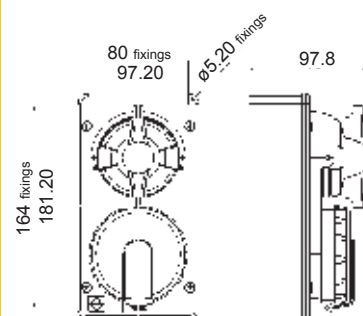

Notes for all products:

- Switch handle is mechanically arranged to prevent the plug from being inserted or withdrawn in the 'on' position
- Supplied unwired between switch & socket
- All products feature a bayonet style socket cap with 180° opening
- 2P+E products feature a 2pole switch
- 3P+E & 3P+N+E products feature a 4pole switch

WEATHERTIGHT METAL CLAD RANGE

MIGHTYSEAL

IP66 Watertight switch socket

- Heavy duty metal construction
- Plain undrilled sides
- Lid can be locked by lever operation, featuring 2 padlocking points
- IP66 ingress protection with or without plug inserted



TYPE	SOCKET ARRANGEMENT	CODE
13A 2gang switched socket 230VAC	BS1363	PD1366DS
13A 2gang switched socket with 230VAC neons	BS1363	PD1366DS-NEON
13A 2gang socket with 30mA RCD protection 230VAC	BS1363	PDRCD1366DS
13A 1gang socket with 45A 2pole switch & neon 230VAC	BS1363	PD1366/45SWT-NEON



- Type X switches are fully rated for fluorescent load operation
- Switches comply to BS EN 60669-1

TYPE	SOCKET ARRANGEMENT	CODE
4gang 10A switch 230VAC	1way type X	PDSWT1366/4
6gang 10A switch 230VAC	1way type X	PDSWT1366/6

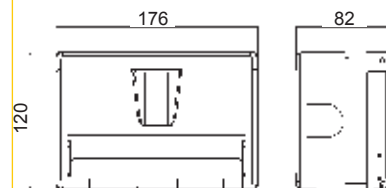

Further combinations available, contact Custom Build for more information

WEATHERTIGHT METAL CLAD RANGE

SWITCHES

Conformity to Standards:	IEC 60669-1 (Sw. 10A)	IEC60947-3 (Sw. 20A+)	Breaking Capacity:	10A X-rated	20 & 30A: AC21A / AC22A
	BS60947-5 (Bell Sw.)	IEC 60529	Temperature resistance:	Operating	- 25 to +50°C
Protection rating:	IP66			Storage	-30 to +70°C
Impact resistance:	>IK 06 (See note)		Cable entry	M20 threaded entry	
Glow wire test:	850°C insert		Connecting sections of the wires	10A	min: 1 max: 1.5mm ²
Self extinguishing:	n/a			20A	min: 1.5 max: 4 mm ²

METAL - SWITCHES & BELL PUSH

IP66 Watertight metal clad switches - round body – 1 Gang



A	GANGS	WAYS	CONDUIT ARRANGEMENT	TYPE 1	TYPE 2
10	1	1	Terminal/ Thru	PD145/NP	PD145/K
	1	2	Terminal/ Thru	PD145/2NP	PD145/2K
	1	Intermediate	Terminal/ Thru	PD236NP	PD236K
20	1	2	Terminal/ Thru	PD219/2NP	PD219/2AM
30	1	1	Terminal/ Thru	PD319NP	PD319AM

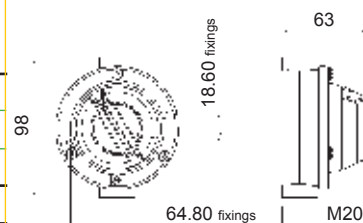

IP66 Watertight metal clad switches – square body – all metal construction – 1 Gang



A	GANGS	WAYS	CONDUIT ARRANGEMENT	CODE
10	1	1	Terminal/ Thru	PDSQ145AM
	1	2	Terminal/ Thru	PDSQ145/2AM
20	1	1	Terminal/ Thru	PDSQ219AM
	1	2	Terminal/ Thru	PDSQ219/2AM

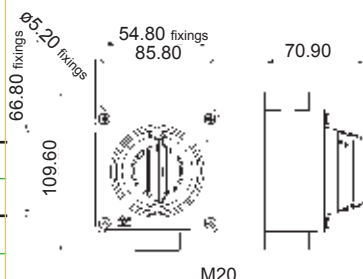

IP66 Watertight metal clad switches - rectangular body – 2 Gang



A	GANGS	WAYS	CONDUIT ARRANGEMENT	TYPE 1	TYPE 2
10	2	1	Terminal/ Thru	PD173NP	PD173K
	2	2	Terminal/ Thru	PD173/2NP	PD173/2K
20	2	1	Terminal/ Thru	PD229N	PD229AM
	2	2	Terminal/ Thru	PD229/2NP	PD229/2AM
30	2	1	Terminal/ Thru	PD329NP	PD329AM

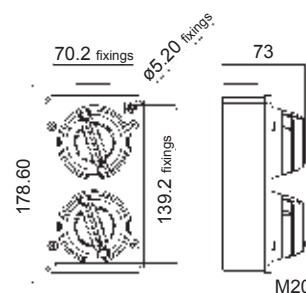

- Type 1 switches feature a metal body shell with a plastic moulded switch handle & cable entry blanking plug
- Type 2 switches are of all metal construction
- All switches are single pole
- Finish is painted metallic

WEATHERTIGHT METAL CLAD RANGE

IP66 Watertight bell push

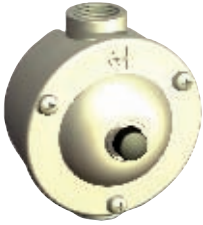

All metal construction with plastic moulded operating knob & cable entry blanking plug

CODE	PD1383NN
------	----------

This bell push is designed for use on A.C mains supply only. It incorporates a rubber diaphragm which moves with the operating knob & is firmly secured between the box & the lid. Contacts are rated 10amps at 600V ac & are momentary.

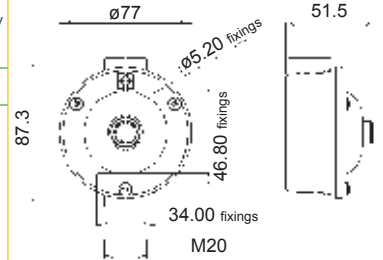

Marshalling box

- Enclosure manufactured from galvanised steel plate with dark grey hammer finish
- Featuring two separate terminal compartments with interconnecting cable routing channel
- The left hand compartment is equipped with an 8 pole screw clamp terminal block rated at 32A 400V, and accepting 4mmsq conductors. This compartment is arranged with a key lockable hinged cover with sealing gasket
- The right hand compartment is equipped with a 16 pole screw clamp terminal block rated at 24A 400V, and accepting 2.5mmsq conductors. This compartment is arranged with a screwed detachable cover with sealing gasket
- The right hand compartment is also furnished with a 3 way chassis mount jack socket 6.35mm (1/4 inch)

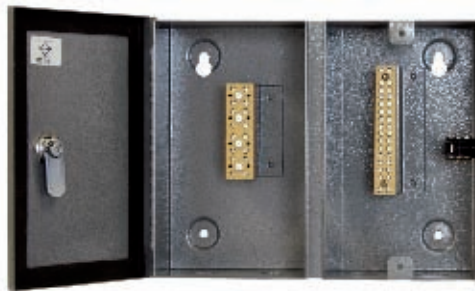

Marshalling box with Jack socket	MO3346
Marshalling box without Jack socket	MO5965

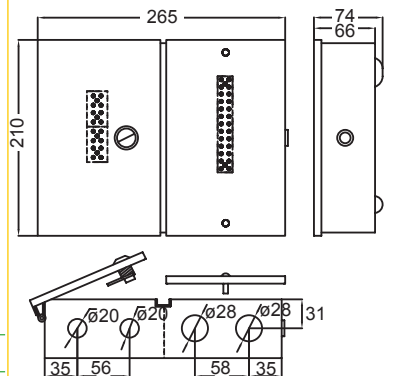

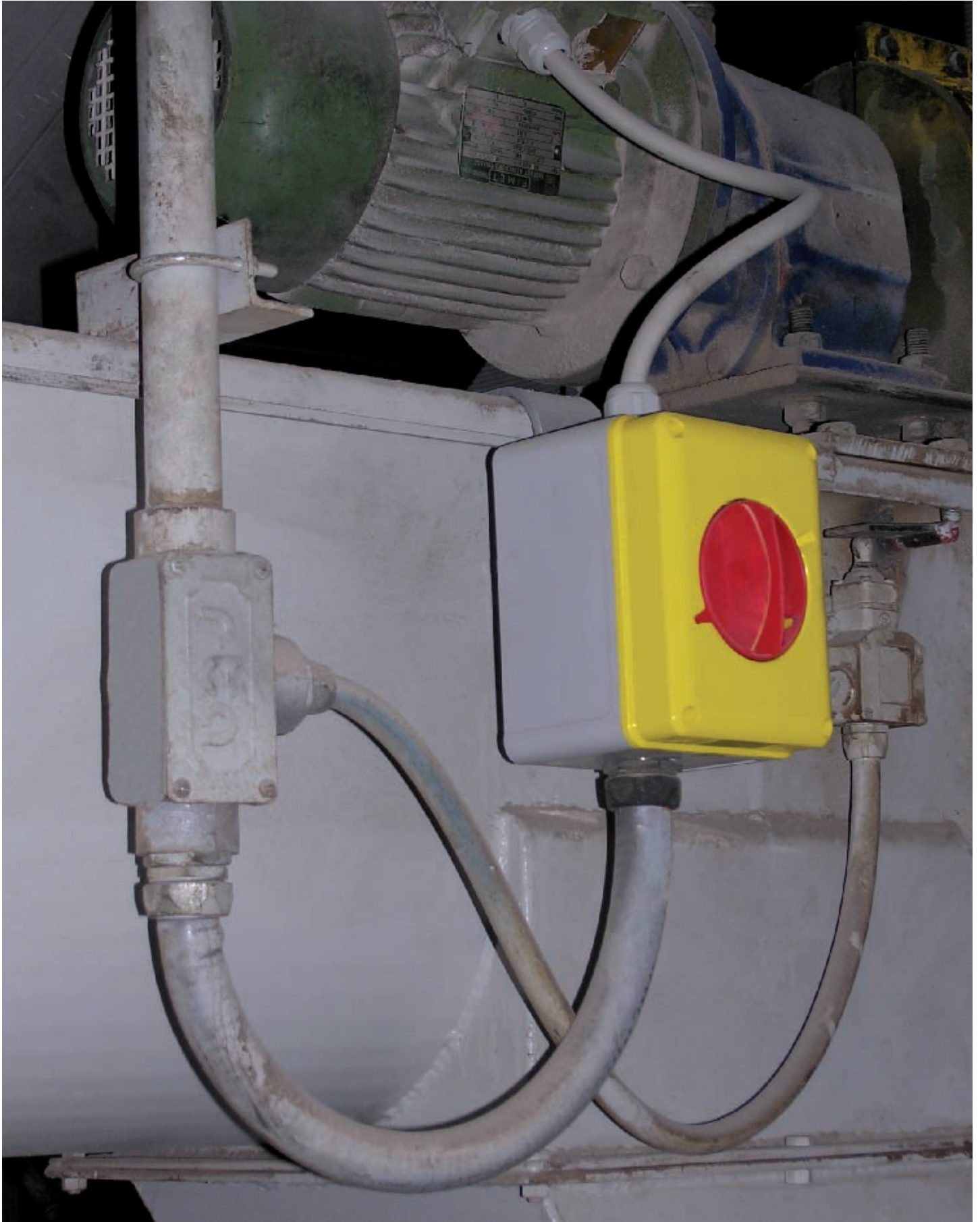

MOULDED ISOLATORS

- A range of thermoplastic enclosed padlockable isolation switches available in 2, 3, or 4 pole options
- Electrical ratings from 16 to 100A with operating voltages up to 415VAC
- Distinctive high visibility red handle on yellow body design
- Ingress protection ratings up to IP65
- Suitable for both top & bottom entry/exit cabling
- All isolators are rated IP65 Watertight
- Door cannot be removed when switch is in the "on" position

Reference should be made to the technical information table for maximum current ratings when operating within the different switching categories

NATURE OF CURRENT	CATEGORY	TYPICAL APPLICATIONS	RELEVANT IEC PRODUCT STANDARD
A.C	AC-20A, AC-20B	Connecting & disconnecting under no-load conditions	60947-3
	AC-21A, AC21-B	Switching of resistive loads, including moderate overloads	
	AC-22A, AC-22B	Switching of mixed resistive & inductive loads, including moderate overloads	
	AC-23A, AC-23B	Switching of motor loads or other highly inductive loads	
	AC-1	Non-inductive or slightly inductive loads, resistance furnaces	
	AC-2	Slip-ring motors: starting, switching off	
	AC-3	Squirrel-cage motors: starting, switching off motors during running	

MOULDED SWITCHES

Conformity to Standards:	BS EN 60947-3 BS EN 60529	Temperature resistance:	Operating: -30 to +50°C Storage: -40 to +80°C
Protection rating:	IP56	Cable entry	4x 25mm knockouts + 2x 20mm adaptors
Impact resistance:	>IK 06	Connecting sections of the wires	max: 35mm ²
Self extinguishing:	V0		
Breaker category	AC3-AC23A - Mixed resistive & inductive loads		

MOULDED ISOLATOR SWITCHES CAM ST

IP65 Watertight rotary isolators



AMPS	POLES	CODE
16	2	PM16/208/2FPB
	3	PM16/208/3FPB
	4	PM16/208/4FPB
25	3	PM25/208/3FPB
	4	PM25/208/4FPB
32	2	PM32/208/2FPB
	3	PM32/208/3FPB
	4	PM32/208/4FPB
40	3	PM40/208/3FPB
	4	PM40/208/4FPB
63	2	PM63/208/2FPB
	3	PM63/208/3FPB
	4	PM63/208/4FPB
100	3	PM100/208/3FPB
	4	PM100/208/4FPB

Operating category AC3 – AC23A
Suitable for switching of motor loads or other highly inductive loads

from 16A to 32A

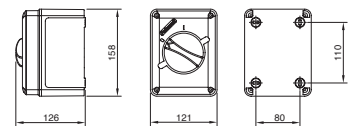

from 40A to 100A

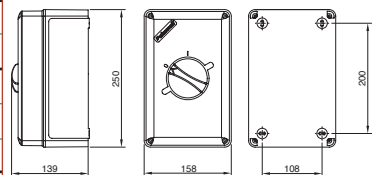

4 POLE ISOLATOR

Conformity to Standards: BS EN 60947-3
BS EN 60529

Protection rating: IP65

Impact resistance: IK 06

Glow wire test:

Self extinguishing: V0

Breaker category: AC22A Mixed resistive & inductive loads

Temperature resistance: Operating -25 to +50°C

Storage -30 to +70°C

MOULDED ISOLATOR SWITCHES

IP56 Watertight 4Pole isolator



AMPS	POLES	CODE
20	4	ISO-20
35	4	ISO-35
63	4	ISO-63

Operating category AC22A

Suitable for mixed residue & inductive loads including moderate overloads

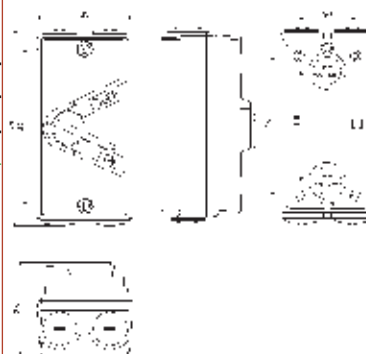

IP65 Watertight 4Pole rotary isolator



AMPS	POLES	CODE
16	4	R-16A/4P
25	4	R-25A/4P
32	4	R-32A/4P
40	4	R-40A/4P
63	4	R-63A/4P

4 pole rotary isolators with door interlock, preventing front cover from being removed when in the ON position.

Knockouts top & bottom.

Can be padlocked in the OFF position.

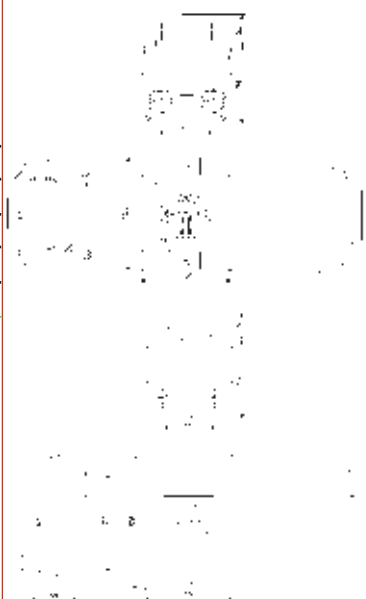

4 POLE METAL ISOLATOR

Conformity to Standards:	BSEN 60947-3 BS EN 60529	Temperature resistance:	Operating -30 to +50°C Storage -40 to +80°C
Protection rating:	IP65	Cable entry	20mm knockouts top, bottom and sides unit can be locked in OFF position
Impact resistance:	IK 08	Connecting sections of the wires	max: 35mm ²
Self extinguishing:	V0		
Breaker category:	AC22A		

3 PHASE ISOLATOR

Conformity to Standards:	BS EN 60947-3 BS EN 60529	Temperature resistance:	Operating -30 to +50°C Storage -40 to +80°C
Protection rating:	IP65	Cable entry - gland plate	GLAND PLATE ON BOTTOM S2503P -GLAND PLATE TOP AND BOTTOM
Impact resistance:	IK08	Connecting sections of the wires	S323P/S633P/S1003P/S1253P max: 35mm ² S2503P (M8 BOLT CONNECTION) max: 50mm ²
Self extinguishing:	V0		
Breaker category	AC21 Resistive loads AC22A Mixed resistive & inductive loads		

ISOLATOR SWITCHES

IP40 4Pole metal isolator



AMPS	POLES	CODE
32	4	M324P

- Toggle style operating handle
- AC22A rated
- Can be locked in 'off' position (padlock not included)
- Manufactured in accordance with BS EN609 47-3



IP40 3Phase isolator



AMPS	POLES	CODE
32	3	S323P
63	3	S633P
100	3	S1003P
125	3	S1253P
250	3	S2503P

- AC22A rated
- Can be locked in 'off' position (padlock not included)
- Manufactured in accordance with BS EN609 47-3



FUSED SWITCHES

Conformity to Standards:	CEI EN 60309-1	IEC 60309-1	Cable entry	16A	2P+E	min: 8	max: 13 mm
	CEI EN 60309-2	IEC 60309-2		32A	3P+E	min: 8.5	max: 14 mm
	CEI EN 60529	IEC 60529			3P+N+E	min: 10	max: 15.5mm
Impact resistance:	>IK 08						
Glow wire test:	850°C insert						
Self extinguishing:	V2						
Temperature resistance:	Operating	-25 to +50°C	Connecting sections of the wires	16A		min: 1	max: 2.5mm ²
	Storage	-30 to +70°C		32A		min: 2.5	max: 6 mm ²

FUSED SWITCHES

IP65 Watertight 3Phase fused switches



AMPS	POLES	CODE
32	3	FS323P
80	3	FS803P
125	3	FS1253P

FS803P - 3x63A + 3x80A fuses
 FS1253P - 3x100A + 3x125A fuses
 Robust steel enclosure
 Generous cabling space
 Lockable in 3 positions (padlocks not included)

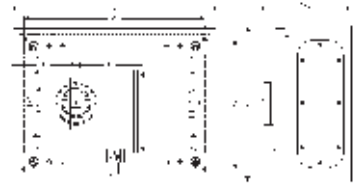

	A	B	C	D	E	F
FS323P	300	250	250	200	100	95
FS803P	400	300	350	250	125	130
FS1253P	400	300	350	250	125	130

IP20 100A fused switch



DESCRIPTION	CODE
100A fused switch including 100A fuses & cable duct (22x58 IEC 60269-2)	MSF100
Cable duct for MSF100	MSF100(CD)

2pole fused switch ideal for the protection & isolation of incoming supplies up to 100A
 Supplied complete with 80A & 100A fuses

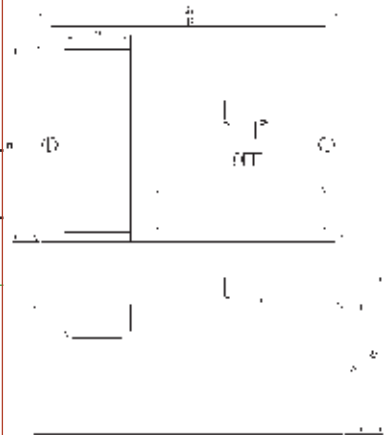



CARAVAN AND MARINE HOOK UP UNITS

- Designed with performance & cost as key factors, these units are intended for applications supplying power to caravans, mobile homes, boats & pleasure crafts etc
- All units comply with BS7671 (17th edition wiring regulations), & feature individual 30mA RCBO protection per socket outlet that isolate both the line & neutral conductors
- Supplied with & without the option of individual KWH check meters per socket.
- KWH meters can be viewed through the transparent RCBO access window without opening
- Lewden offer products featuring either 1, 2, 3, or 4 socket outlet combinations, with 4 being the maximum permitted by the BS7671 regulations
- Ingress protection is IP44 as standard
- 1-3 socket units all utilise the same thermoplastic enclosure type.
- 4 socket units require a larger enclosure which is achieved by utilising the topTER construction system.
- Enclosures are suitable for either wall or galvanised steel stake mounted installation

CARAVAN & MARINE

Conformity to Standards:	CEI EN 60309-1	IEC 60309-1	Breaker category	30mA 'B' rated
	CEI EN 60309-2	IEC 60309-2	Temperature resistance:	Operating -25 to +50°C
	CEI EN 60529	IEC 60529	Storage	-30 to +70°C
	BS EN 61009-1	EN 62053-21	Cable entry	20mm knockouts
Protection rating:	IP44		Connecting sections of the wires	16A min: 1.5 max: 4mm ²
Impact resistance:	>IK 06			32A min: 2.5 max: 10mm ²
Glow wire test:	850°C sockets		Note:	Larger cable or multi cable connection is possible to connector blocks.
Self extinguishing:	n/a			

HOOK - UP UNITS

IP44 Splashproof - combination unit



A	V	No. of SOCKETS	 2P+E
16	230	1	PMRCBO16/16-1
16	230	1	PMRCBO16/16-1M
32	230	1	PMRCBO32/32-1M

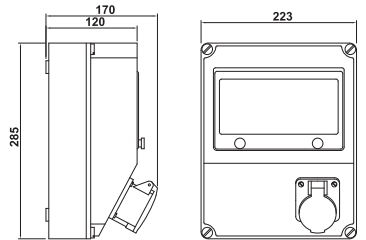

IP44 Splashproof - combination unit



A	V	No. of SOCKETS	 2P+E
16	230	2	PMRCBO16/16-2
16	230	2	PMRCBO16/16-2M

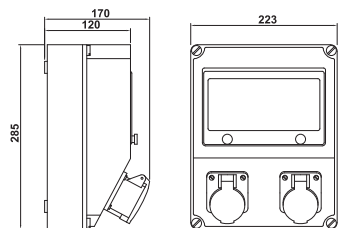

IP44 Splashproof - combination unit



A	V	No. of SOCKETS	 2P+E
16	230	3	PMRCBO16/16-3
	230	3	PMRCBO16/16-3M
	230	4	PMRCBO16/16-4
	230	4	PMRCBO16/16-4M

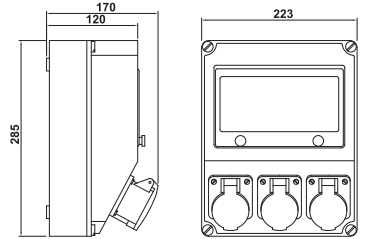

Mounting Stake	Length of 1.5 mt	MS15U
----------------	------------------	-------

B-SMART

Conformity to Standards:	CEI EN 60409-1	IEC 17-13/1	Lighting:	9W 230V fluorescent lamp (all models)
	IP56		Insulation class:	II
Impact resistance:	>>IK 10		Temperature resistance:	Operating -25 to +50°C
Protections:	1 RCD for each socket-outlet 30mA			Storage -30 to +70°C

- Maintenance free, non toxic, flame proof, smoke free, rodent proof
- Extremely long life
- Resistant to sun, salt & impacts caused by the sea & daily use
- Applications: marinas, campsites, gardens, parks, industrial areas etc
- Stainless steel Grade 316 construction enables the B-Smart turret series to be used in the most hostile & corrosive of environments

B-SMART SERIES



IP56 Watertight compact turrets in AISI 316L stainless steel for wharfs with 2 industrial socket-outlets and 2 water taps Class II - >> IK10



Industrial socket-outlets  2P+E - 220V	Dimensions (mm)	Code
2x16A	360x905x208	576100
1x16A / 1x32A	360x905x208	576101

IP56 Watertight compact turrets in AISI 316L stainless steel for wharfs with 2 interlocked socket-outlets and 2 water taps Class II - >> IK10



Industrial interlocked socket-outlets			Dimensions (mm)	Code
 2P+E - 220V	 3P+E - 380V	 3P+N+E - 380V		
2x16A			360x965x208	576110
1x16A 1x32A			360x965x208	576111
		2x63A	360x965x208	576112
		1x32A 1x63A	360x965x208	576113

IP56 Watertight standard turrets in AISI 316L stainless steel for wharfs with 4 interlocked socket-outlets and 4 water taps Class II - >> IK10



Industrial interlocked socket-outlets			Dimensions (mm)	Code
2P+E - 220V	3P+E - 380V	3P+N+E - 380V		
4x16A			360x967x276	576200
4x32A			360x967x276	576201
2x16A	2x16A		360x967x276	576202
2x16A 2x32A			360x967x276	576203
2x16A		2x16A	360x967x276	576205
2x16A	1x16A	1x32A	360x967x276	576206

IP56 Watertight turret for wharf-end in AISI 316L stainless steel prepared for protection devices Class II - >> IK10



No. of modules EN50022	Dimensions (mm)	Code
36 (12x3)	360x967x276	576800

IP56 Watertight AISI 316L stainless steel standard turrets for camp sites with 4 industrial socket-outlets Class II - >> IK10



Industrial socket-outlets	Dimensions (mm)	Code
2P+E - 220V		
4x16A	360x967x276	576401



Industrial socket-outlets	Dimensions (mm)	Code
2P+E - 220V		
4x16A	360x967x276	576400

IP56 Watertight fire prevention turrets in AISI 316L stainless steel for an extinguisher Class II



Extinguisher can be fitted	Dimensions (mm)	Code
1 extinguisher 6 or 9 Kg	360x967x276	576600

Extinguisher not provided
Includes flat breakable glass with 'safe crash' patent turret supplied with 9W fluorescent light with a red diffuser.
G23 lamp holder – lamp not supplied.



Extinguisher can be fitted	Dimensions (mm)	Code
Fire hose & nozzle	360x967x276	576601

20 meters of 'Gomel' fire hose 45mm diameter
ANG UNI45 nozzle with 3 effects complete with 1½ UNI45 brass tap

Support base for turrets

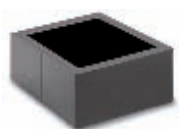

For turret type	Application	Material	Code
Compact	Rising 65 mm and floor-mounted	Stainless	575701
Standard		inox	575702

Decorative and containment frame in stainless steel for ground distribution turrets



Description	For turret type	Code
Stainless steel frame with fixing screws	compact	575711
	standard	575710

Flat breakable "SAFE CRASH" glass for fire prevention turrets



Description	Code
flat breakable glass with "SAFE CRASH" patent	575706

Lock kit for distribution turret doors for marinas and camp sites



Description	Code
Kit with 2 keys with standardised code	575708



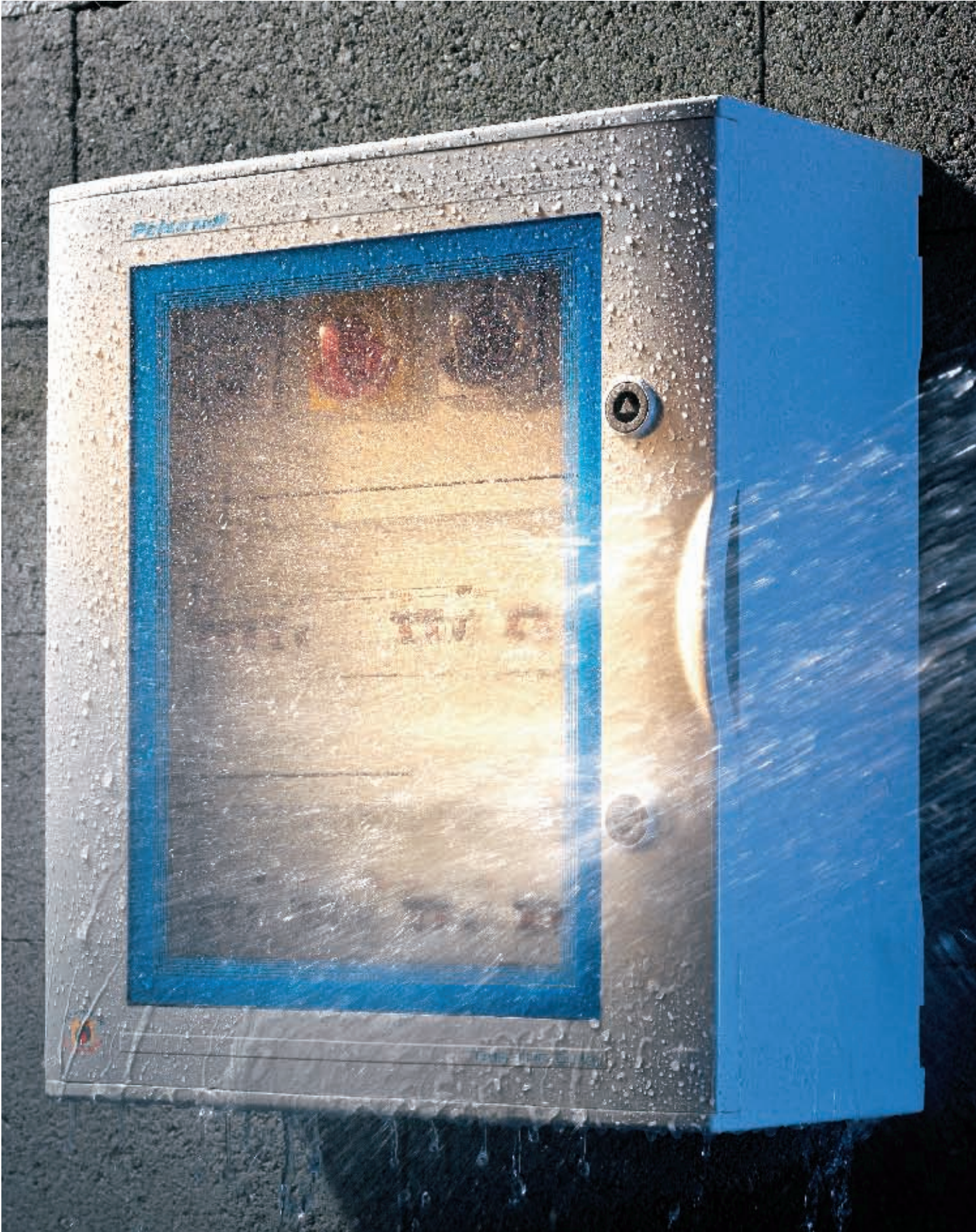

- Enclosures in this section are offered in four different material types including thermosetting material, mild steel, stainless steel grade 304, & heavy duty rubber
- The TAIS TRE enclosure system is manufactured from flame & corrosion proof thermosetting material with IP66 ingress protection. Enclosures are supplied in a range of sizes featuring either a plain or glazed access door. This easy to assemble product incorporates an extensive range of accessories, making this a truly versatile enclosure system
- The mild steel enclosure family is IP65 ingress protected, & features a double bar type lockable access door & detachable gland plate on the bottom face.
The enclosure design incorporates a folded & welded single part body, with gutter shaped double folded front edge & polyurethane door seal.
Steel enclosures offer a high impact resistance
Enclosures are supplied complete with a mild steel equipment mounting plate. Accessories include a key type lock & wall mounting external bracket sets.
- Enclosures in the stainless steel family have a similar design styling to the mild steel range. The 304 grade stainless steel construction makes the enclosures particularly suitable for installation in industrial sectors where cleanliness, hygiene & resistance to corrosion are of paramount importance, such as in the chemical, petroleum, food & agricultural industries
- The heavy duty rubber enclosure range comprises an array of shapes & sizes. Enclosures offer high impact resistance & are particularly suited to the manufacture of portable electrical distribution units for the film/TV, entertainment & temporary events markets.
- Lewden are pleased to offer fully assembled, wired & tested electrical power distribution units (incorporating circuit protection devices) to meet individual client specification requirements, constructed from any of the above listed enclosure ranges

Contact our custom build division for further details

THE TECHNIQUE



TAIS TRE – IP66 WATERTIGHT BOARDS IN THERMOSETTING MATERIAL

The new TAIS TRE board range in thermosetting material is designed and built to withstand high temperature in total safety. The special resin of this material in fact does not burn, it does not give off toxic fumes and, in case of a short circuit, there is no flame propagation outside the board. TAIS TRE is not only fireproof but it is also waterproof and guarantees resistance against humidity and water. The basic range of TAIS TRE boards comes in seven sizes from 265x300mm to 850x1005mm, with blind or transparent doors. In both versions the components click onto the rails inside the board, and they are fixed in place using a screwdriver on a screw which needs 1/4 turn. The gasket in non-ageing elastomer guarantees IP66 protection rating. Access to the board is protected by two safety locks.

The TAIS TRE boards use the shapes and colours of the interlocked socket-outlets from the same range and likewise guarantee top-rate electrical and thermal insulation plus resistance to chemical action.

APPLICATIONS:

It is recommended to install the TAIS TRE board in areas which are most subject to fire risks, such as: power-electric plants, mineral oil and combustion gas extraction plants, nuclear laboratories and plants, closed storage of combustion materials, retail and showroom areas, airports, railway infrastructures and undergrounds and all other environments where distribution and automation require precise safety requirements and constant service.

THE ADVANTAGES



IP66



RELIABILITY MADE IN TAIS

The flame proof TAIS TRE BOARDS IN THERMOSETTING MATERIAL are designed and built to withstand high temperatures. Due to a series of particular technical processes, this material is VO self-extinguishing, it does not give off toxic fumes, it does not deform and remains watertight in all possible conditions.

HARD FIBRE BOARDS

TAIS TRE has a dimensional stability which is similar to steel. Special technical processes and special resins make this material waterproof and guarantees resistance against humidity and water. It is the ideal solution in locations where cleaning operations are performed using machines with powerful jets of water.

CORROSION-PROOF

The material used by Palazzoli is a combination of a thermosetting resin base with reinforced fibres and cells (GRP-glass reinforced plastic). The same material is used in the aeronautic sector (for instance on the Boeing 777) as it is sturdy and light and is stress, corrosion and impact resistant.

EASY TO ASSEMBLE

All you need is one screwdriver to assemble and disassemble the various components.



REALLY SIMPLE WIRING, ASSEMBLING AND MAINTENANCE

The blind panels boards and supports can be wired outside the board. The frame can be fitted with cable runners fastened by self-threading screws for plastic on the back \varnothing 3,5mm with a max length of 15mm, behind the DIN rails.



WATERTIGHT GEOMETRY



The geometry of the internal perimeter guarantees IP66 protection rating. It is water resistant up to 100 litres a minute.

QUICK ASSEMBLY



No tools are needed during installation. The doors hook onto the brackets and are reversible.

MAXIMUM VERSATILITY



The DIN rails are adjustable and allow you to fit 47 and 75 mm modular devices. This operation requires a simple adjustment of the central screw on the DIN bearing structure.

ADAPTABLE TO SUIT REQUIREMENTS



The sliding parts allow you to position the mounting plate at different heights.

The IP66 Distribution board system in thermosetting GRP material



Sizes	No. vertical modules	No. DIN modules	Overall external dimensions			Overall internal dimensions			Blind board	Board with transparent door	Open panel	Blind panel
			L (mm)	H (mm)	D (mm)	L (mm)	H (mm)	D (mm)				
1	-	-	265	300	165	213	251	146	530001	530031	-	-
2	3	36 (3x12)	325	425	180	272	376	162	530002	530032	530520	530540
3	3	54 (3x18)	430	500	210	380	451	189	530003	530033	530521	530541
4	4	72 (4x18)	430	650	210	380	601	189	530004	530034	530521	530541
5	4	96 (4x24)	540	650	260	488	601	243	530005	530035	530522	530542
6	5	140 (5x28)	615	805	315	560	751	297	530006	530036	530523	530543
7	5	190 (5x38)	810	1060	355	-	-	-	530007	530037	530524	530544

Distance between blind door and panels A (mm)	Distance between blind door and outer door B (mm)	Distance between blind door and plate C (mm)	Distance between transparent door and plate C (mm)
-	-	138	135
40-67	44/74	154	151
40-67-94	44/74	181	178
40-67-94	44/74	181	178
40-67-94-121-148	44/74	236	233
40-67-94-121 148-175-202	44/74	290	287

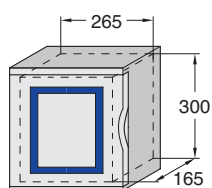
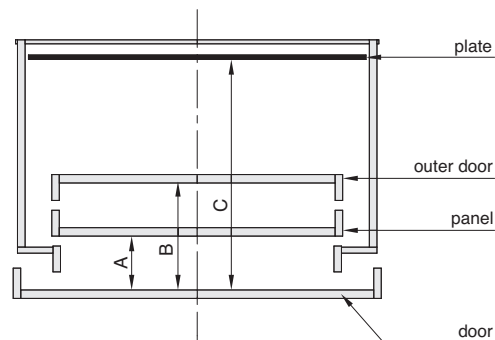

SIZE 1

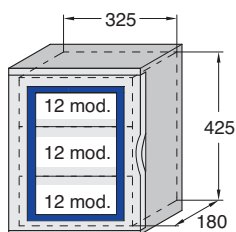

SIZE 2

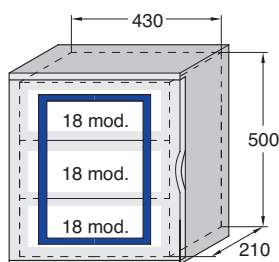



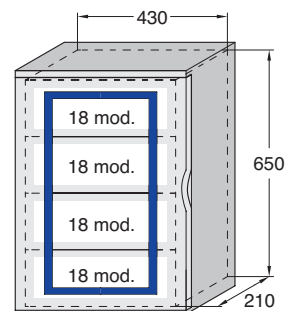





SIZE 3



SIZE 4

ENCLOSURES

									
Double blind panel	Outer door	Bottom steel plate	Bottom insulating plate	DIN rail	Supports	Sliding accessories	Insulation brackets steel	Insulation brackets steel	Safety lock
-	-	530601	530621	-	-	-	530640	530641	530680
530550	530501	530602	530622	530580	530560	530660	530640	530641	530680
530551	530502	530603	530623	530581	530561	530660	530640	530641	530680
530551	530503	530604	530624	530581	530562	530660	530640	530641	530680
530552	530504	530605	530625	530582	530562	530660	530640	530641	530680
530553	530505	530606	530626	530583	530563	530660	530640	530641	530680
530554	530506	530607	-	530584	530564	530660	530640	530641	530680

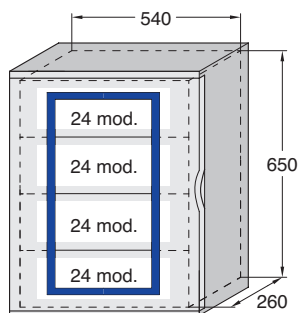

SIZE 5

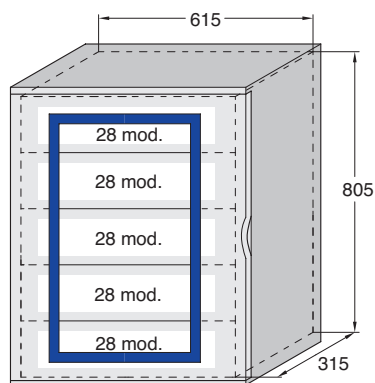

SIZE 6

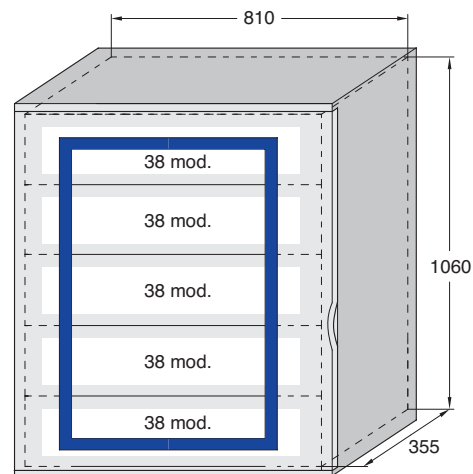

SIZE 7

ENCLOSURES

Conformity to Standards:	CEI EN 60529	IEC 60529	Self-extinguishing:	V2
Protection rating:	IP65		Insulation:	double e
Impact resistance:	> IK 08		Temperature resistance:	Operating -25 to +50°C
Glow-wire test:	750°C			Storage -30 to +70°C

IP56 Watertight topTER series flush mounted control unit in thermoplastic material

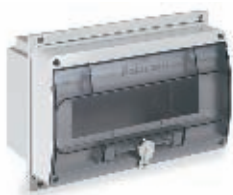

External dimensions (mm)	No. of modules EN 50022	Available power (W)	Code
284x172	12	40	575506

IP65 Watertight junction boxes with knockouts in thermoplastic material



External dimensions (mm)	Internal dimensions (mm)	No of entres	Code
88x88x53	63x70	7xM20	791910
98x98x58	73x78	7xM25	791920
139x119x70	128x86	6xM25/M32, 4xM25	791930
167x125x82	136x112	10xM25/M32	791940
200x160x98	168x145	10xM32/M40	791950
310x210x116	278x185	12xM25/M32, 4xM40/M50	791960

IP65 Watertight topTER series wall-mounted control unit in thermoplastic material



External dimensions (mm)	No. of modules EN 50022	Available power (W)	Code
121x158	5	20	579708
158x250	12	40	579709

IP55 Watertight Prima series wall-mounted control unit in thermoplastic material



External dimensions (mm)	No. of modules EN 50022	Available power (W)	Code
212x114	9	36	579612

TAIS - MIGNON SERIES

Conformity to Standards:	CEI EN 60529	IEC 60529	Self-extinguishing:	V0
Protection rating:	IP65/IP67/IP68		Insulation:	double e
Impact resistance:	> IK 10		Temperature resistance:	Operating -40 to +70°C
Glow-wire test:	960°C			Storage -50 to +80°C

TAIS SERIES

IP66/IP67 Watertight Control units in thermosetting GRP material



External dimensions (mm)	No. of modules EN 50022	Available power (W)	Code
125x185	5	15	532300
190x185	8	20	532301
250x185	12	24	532302
290x185	14	28	532303
380x185	19	35	532304

IP67 Watertight Tais series wall-mounted enclosures with blind walls, low cover, in thermosetting GRP material



External dimensions (mm)	Box height (mm)	Cover height (mm)	Code
92x92	50	18	532035
125x92	50	18	532045
185x92	50	18	532055
125x125	75	25	532116
185x125	75	25	532117
250x125	75	25	532118

IP66/IP67 Watertight Rapid mounting enclosure with blind walls, in thermosetting GRP material >IK10



External dimensions (mm)	Hole type	Code
125x185	blind	532200
190x185	blind	532201
190x185	2 holes ø 25mm lower side	532211
250x185	blind	532202
290x185	blind	532203
380x185	blind	532204

IP67 Watertight wall-mounted enclosures with blind walls, high cover, in thermosetting GRP material



External dimensions (mm)	Box height (mm)	Cover height (mm)	Code
92x92	50	50	532005
125x92	50	50	532006
185x92	50	50	532015
125x125	75	50	532016
185x125	75	50	532017
250x125	75	50	532018

IP68 Watertight wall-mounted enclosures with blind walls, low cover, in thermosetting GRP material



External dimensions (mm)	Box height (mm)	Cover height (mm)	Code
92x92	50	50	538005
125x92	50	50	538006
185x92	50	50	538015
125x125	75	50	538016
185x125	75	50	538017
250x125	75	50	538018

IP68 Watertight wall-mounted enclosures with blind walls, high cover, in thermosetting GRP material



External dimensions (mm)	Box height (mm)	Cover height (mm)	Code
92x92	50	18	538035
125x92	50	18	538045
185x92	50	18	538055
125x125	75	25	538116
185x125	75	25	538117
250x125	75	25	538118

Mounting plates in anti-corrosion tropicalised steel, for watertight enclosures



For enclosure with dimensions	For enclosure with code	Code
92x92	532005, 532035, 532225, 538005, 538035, 532005EX, 532035EX	532705
125x92	532006, 532045, 532285, 532295, 538006, 538045, 532006EX, 532045EX	532714
185x92	532015, 532055, 532325, 532385, 538015, 538055, 532015EX, 532055EX	532715
125x125	532016, 532116, 532346, 538018, 538118, 532016EX, 532116EX	532716
185x125	532017, 532117, 532667, 532677, 538017, 538117, 532017EX, 532117EX, 532667EX	532717
250x125	532018, 532118, 532618, 532628, 532638, 532648, 538016, 538116, 532018EX, 532118EX, 532628EX	532718

Uses:
for fastening terminal blocks or non-modular devices.

ALUPRES SERIES

Conformity to Standards:	CEI EN 60529	IEC 60529	Temperature resistance:	Operating	-40 to +70°C
Protection rating:	IP67/IP54			Storage	-50 to +80°C
Impact resistance:	>> IK 10				

ALUPRES SERIES

IP67 Watertight enclosures in aluminium alloy with blind walls



External dimensions (mm)	Code
92x92x66	150006
125x125x73	150016
155x155x73	150026

IP67 Watertight boxes with blind walls enclosures in aluminium alloy, with mounting plates in tropicalised steel



External dimensions (mm)	Code
92x92x42	511110
125x125x63	511210
185x125x63	511220
155x155x63	521210
185x185x95	511310
252x185x95	511320
315x252x140	511420

IP67 Watertight low blind covers for enclosures in aluminium alloy



For box with dimensions (mm)	Cover height (mm)	Code
92x92	23	515111
125x125	10	515200
185x125	25	515221
155x155	10	525200
185x185	10	515300

IP67 Watertight high blind covers for enclosures in aluminium alloy



For box with dimensions (mm)	Cover height (mm)	Code
92x92	35	515112
125x125	50	515214
185x125	50	515224
185x185	50	515313
252x185	57	515323
315x252	53	515423

IP67 Watertight control units with blind walls, transparent door and EN50022 rail in aluminium alloy



External dimensions (mm)	No. of modules EN50022	Box height (mm)	Cover height (mm)	Door height (mm)	Code
125x125	4	63	50	30	512204
185x125	6.5	63	50	30	512206
252x185	11	95	50	30	512211

COMPACT SERIES

Conformity to Standards:	CEI EN 60529	IEC 60529	Impact resistance:	>> IK 10
Flame resistance:	flat terminals 850°C for 90'		Small parts:	Captive stainless steel screws

An extensive range of terminals designed for installation within Alupres & Tais Series enclosures as displayed on pages 113 - 116

COMPACT SERIES

Junction terminal blocks for watertight enclosures



V	For enclosures with dimensions (mm)	No. Poles for section	Casing material	Code
400	92x92	4x6 mm ²	Ceramic	532725
400	92x92	4x6 mm ²	Thermoplastic	532735
400	92x125, 92x185, 125x125, 125x185	4x6 mm ²	Ceramic	532745
400	92x125, 92x185, 125x125, 125x185	6x6 mm ²	Ceramic	532765
500	92x185, 125x125, 125x185	4x16 mm ²	Ceramic	532747
500	125x250	4x16 mm ²	Ceramic	532748
500	92x92	6x4 mm ²	Thermosetting	532755
500	125x250	6x16 mm ²	Ceramic	532768

Terminal blocks for watertight boxes



V	No. Poles for section	For box code	Code
500	4x50 mm ²	791960	791961
500	5x50 mm ²	791960	791971

Junction terminal blocks for watertight boxes - 380V



No. Poles for section	Code
4x6 mm ²	101096

Insulated terminal blocks for watertight boxes



V	No. Poles for section	For box code	Code
500	5x4 mm ²	791910, 791920	791911
500	5x6 mm ²	791930	791931
500	5x10 mm ²	791940	791941
500	5x25 mm ²	791950	791951

Junction terminal blocks for watertight boxes - 500V



No. Poles for section	Code
4x6 mm ²	101095

Junction terminal blocks with mantle terminals for junction boxes - 500V



No. Poles for section	Code
4x6 mm ²	112094
4x10 mm ²	113094

Minimum and maximum values of the copper wire section suitable to the connection (extract from the standard CEI EN 60439-1)

Rated current (A)	Rigid wire section (mm ²)		Flexible wire section (mm ²)	
	min.	max	min.	max
16	1,5	4	1	4
32	2,5	10	1,5	6
40	4	16	2,5	10
63	6	25	6	16
100	16	50	16	35
125	25	70	25	50
160	35	95	35	70
200	50	120	50	95
250	70	150	70	120
315	95	240	95	185

Junction terminal blocks with mantle terminals for watertight enclosures - 400V



V	For enclosures with dimensions (mm)	No. Poles for section	Code
400	92x92	4x16 mm ²	113194

Junction terminal blocks with flat terminals for watertight enclosures



V	For enclosures with dimensions (mm)	No. Poles for section	Code
500	92x92	3x16 mm ²	159030
500	125x125	3x25 mm ²	159032
500	155x155	3x16 mm ²	159033
500	185x185	3x70 mm ²	159034
500	220x220	3x125 mm ²	159035
500	295x295	3x200 mm ²	159036
500	373x373	3x315 mm ²	159037
500	125x125	4x16 mm ²	159040
500	155x155	4x25 mm ²	159042
500	185x185	4x40 mm ²	159043
500	220x220	4x70 mm ²	159044
500	295x295	4x125 mm ²	159045
500	373x373	4x200 mm ²	159046

GRP ENCLOSURES

Conformity to Standards:	EN60529 IEC60529	Self extinguishing:	V0
Protection rating:	IP65	Braker category:	
Impact resistance:	IK10	Temperature resistance:	Operating -40 to +80°C Storage -40 to +80°C
Glow wire test:	850°C		

IP65 Watertight GRP enclosure



DIMENSIONS	CODE
300 x 250 x 140	GRP-302514
400 x 300 x 200	GRP-403020
500 x 400 x 200	GRP-504020

Supplied complete with backplate & wall mounting kit
Polyurethane gasket

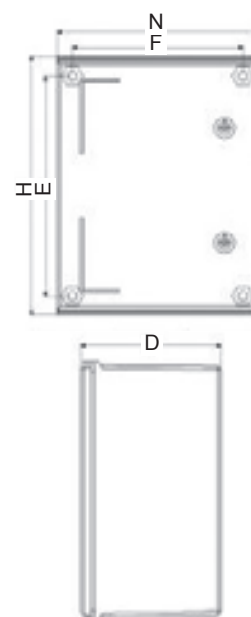

STEEL ENCLOSURES

Conformity to Standards:	BS EN60529 to 65	Temperature resistance:	Operating	-40 to +100°C
Protection rating:	IP65		Storage	-50 to +180°C
Impact resistance:	IK10	Cable entry:	Gland plate at bottom	
Glow wire test:			Reversible door	
Self extinguishing:	n/a		1.2mm sheet steel finished in RAL7035	
Braker category:	n/a		Supplied complete with zinc plated backplate	

STEEL

IP65 Watertight steel enclosures



DIMENSIONS mm.			CODE
HEIGHT (A)	WIDTH (B)	DEPTH (C)	
300	250	200	WME-3025/200
300	300	150	WME-33/150
400	300	150	WME-43/150
400	400	200	WME-44/200
500	400	150	WME-54/150
500	400	200	WME-54/200
600	400	200	WME-64/200
600	500	200	WME-65/200
600	600	200	WME-66/200
700	500	200	WME-75/200
KEYLOCK			WME-KL
WALL MOUNTING KIT			WME-WMK

- Finish colour RAL7035
- Reversible door with T bar lock
- Polyurethane door gasket
- Recessed glad plate on bottom face
- Supplied complete with galvanised steel inner mounting plate

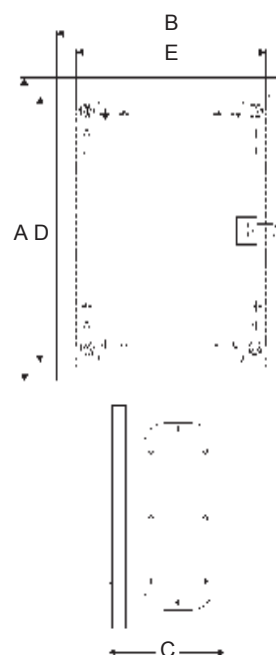

STAINLESS STEEL ENCLOSURES

Conformity to Standards:	BS EN60529 to IP65	Temperature resistance:	Operating	-40 to +100°C
Protection rating:	IP65		Storage	-50 to +180°C
Impact resistance:	IK10	Cable entry:	Gland plate at bottom	
Glow wire test:			Reversible door	
Self extinguishing:	n/a		1.2mm stainless steel grade 304	
Braker category:	n/a		Supplied complete with zinc plated backplate	

STAINLESS STEEL

IP65 Watertight 304 grade stainless steel enclosures



DIMENSIONS mm.			CODE
HEIGHT (A)	WIDTH (B)	DEPTH (C)	
250	250	150	SSE-2525/150
300	250	250	SSE-3025/200
300	300	150	SSE-33/150
400	300	150	SSE-43/150
400	400	200	SSE-44/200
500	400	200	SSE-54/200

- Polished finish
- Reversible door with T bar lock
- Polyurethane door gasket
- Recessed gland plate on bottom face
- Supplied complete with inner mounting plate

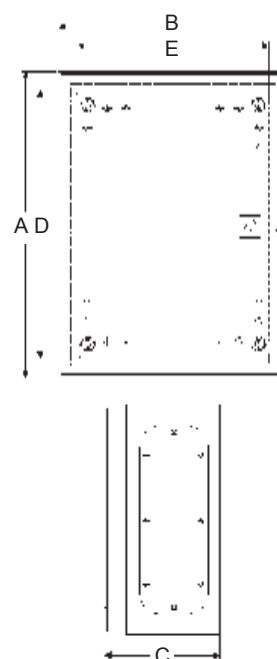

RUBBERISED ENCLOSURES

Conformity to Standards:	BS EN60529 to IP65	Temperature resistance:	Operating	-20 to + 50°C
Protection rating:	IP54		Storage	-30 to + 65°C
Impact resistance:	IK10	Cable entry:	Cut to position and size	

RUBBERISED

IP54 Splashproof



No. OF 17.5mm MODULES	CODE
12	PRB12S

- Portable
- Integral carry handle & legs
- Includes mounting brackets for din rail devices unhinged lid
- Finger-proof shield plate – un-machined

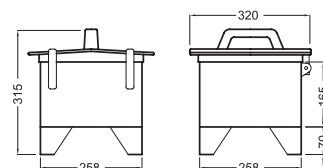

IP54 Splashproof



No. OF 17.5mm MODULES	CODE
10	PRB10

- Portable
- Integral carry handle & legs
- Transparent hinged access window

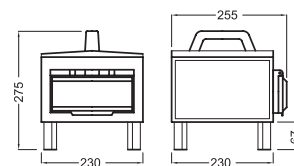

IP54 Splashproof



No. OF 17.5mm MODULES	CODE
12	PRB12L

- Portable
- Integral carry handle
- Transparent hinged access window

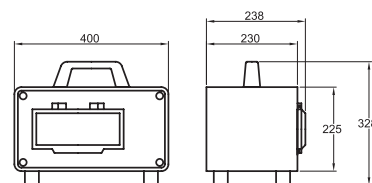

IP55 Splashproof



CODE
PMB360

- Portable
- Integral carry handle
- Screw on cover

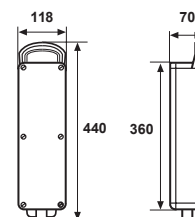

IP54 Splashproof



No. OF 17.5mm MODULES	CODE
12	PRB22

- Suitable for wall mounting
- Hinged front cover

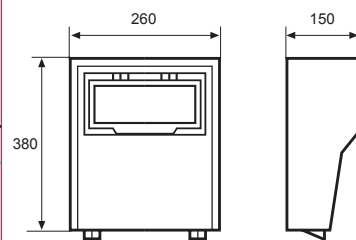

IP54 Splashproof



DIMENSIONS mm			CODE
HEIGHT (A)	WIDTH (B)	DEPTH (C)	
260	145	80	PRB230
231	145	80	PRB231

- Handle PRB5010
- Design incorporates screw on cover

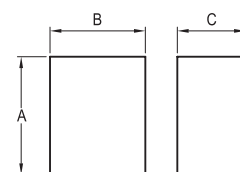

IP65 Splashproof



CODE
PRB570

- Handle PRB5010 Extra
- Design incorporates 1x screen on flat side panel for equipment mounting

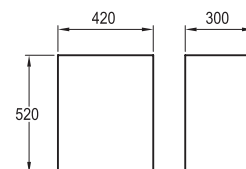

Accessories



CODE
PRB5010

- Handle PRB5010 Extra
- Design incorporates 1x screen on flat side panel for equipment mounting

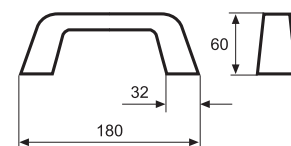

No. OF 17.5mm WIDE MODULES	CODE
12	PRB5412

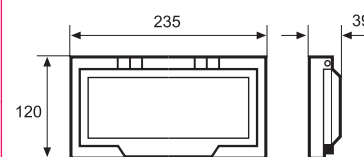

Combi blok

- A compact & extremely durable rubberised enclosure equipped with varying socket outlet combinations, providing the user with a lightweight & portable multi-gang extension unit.
- Our most popular socket combinations are displayed in the adjacent part number table
- Lewden are pleased to offer fully assembled, wired & tested multi-gang Combi Bloks to meet individual client socket specification requirements (incorporating up to a maximum of 4 sockets)

Contact our Custom Build team for further details

RUBBER COMBI BLOKS

IP44 Splashproof



A	V	No. of SOCKETS	Diagram
			 2P+E
16	110	2	PMB16/3000/2N
		3	PMB16/3000/3N
		4	PMB16/3000/4N
	230	2	PMB16/3100/2N
		3	PMB16/3100/3N
		4	PMB16/3100/4N

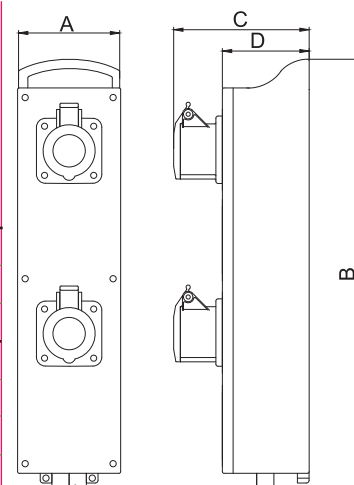

M20 CABLE ENTRY GLAND

Rated current (A)	Poles	A (mm)	B (mm)	C (mm)	D (mm)
16	2P+E	115	430	55	48
	3P+E	115	430	55	48
	3P+N+E	115	430	55	48



- Lewden are pleased to offer fully assembled, wired & tested electrical power distribution units (incorporating circuit protection devices) to meet individual client specification requirements, constructed from any of the above listed enclosure ranges

Contact our custom build division for further details

CABLE AND CONDUIT FITTINGS



CABLE AND CONDUIT FITTINGS

CABLE & CONDUIT FITTINGS

Conformity to Standards:	CEI EN 60309-1	IEC 60309-1	Glow wire test:	850°C insert
	CEI EN 60309-2	IEC 60309-2	Self extinguishing:	V2
	CEI EN 60529	IEC 60529	Temperature resistance:	Operating -25 to +50°C Storage -30 to +70°C
Impact resistance:	>IK 08			

DIE-CAST ACCESSORIES

Screwed hooks (male)



	E.C.T.	MAX WORKING LOAD	CODE
Standard	20mm	10kgs	PD292

N.B. Maximum ambient operating temperature 60°C

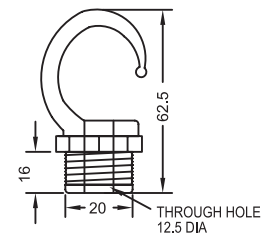

Ceiling hook plates



MAX WORKING LOAD	CODE
10kgs	PD293

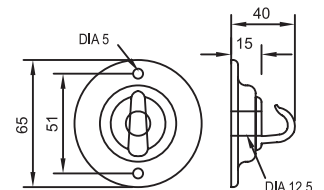

Screwed dome covers



THREAD SIZE	CODE
20	PD411

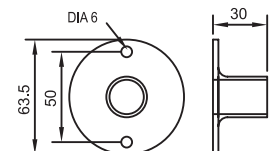

CABLE AND CONDUIT FITTINGS

Ball and socket cover



CODE
PD1307A

Spring Loaded with Captive Screws

These circular swivel-jointed ball and socket units have a 20mm ISO metric thread. There is a braided copper earth link between the ball joint and the case. They are made from pressure die-cast Zinc Alloy and finished in a black epoxy resin stoved powder coating. The ball has a nominal movement of 15° in any direction.

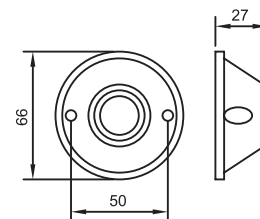

Cable glands for flexible cables with steel tape armouring



ISO METRIC THREADS mm	TO FIT CABLE mm	CODE
20 MALE	10-12	PD427
25 MALE	12-20	PD428
1 1/4" MALE	20-25	PD429

- These products do not incorporate a weatherproof seal

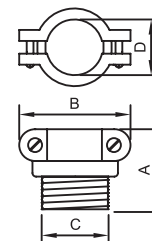

Bonding nipples



ISO METRIC THREADS mm	CODE
20mm male	PD435

- For glanding of flat cable
- This product does not incorporate a weatherproof seal

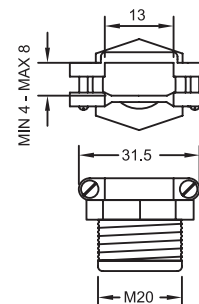

Metric/imperial adaptors



MALE	FEMALE	CODE
3/4"	20mm	PD1452A
20mm	3/4"	PD1452B

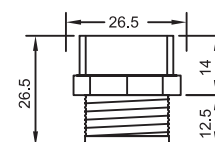

CABLE AND CONDUIT FITTINGS

Cable glands

- A selection of brass cable glands suitable for all types of steel wire armoured cables, providing mechanical cable retention, & electrical continuity via armour wire termination
- Glands are manufactured in accordance with BS6121
- Each gland is supplied with a locknut, earth tag, & PVC shroud
- BW types do not incorporate a seal, & are suited to indoor installations only
- CW types feature an elastomer displacement seal which makes them suitable for outdoor installations
- Glands up to 32mm are supplied in a pack of two. Sizes above this are supplied individually

BRASS ARMoured CABLE GLAND PACKS

Type BW to BS6121 (for indoor application)



CODE	ENTRY THREAD SIZE mm	PACK SIZE
BW20S	20s	2
BW20	20	2
BW25	25	2
BW32	32	2
BW40	40	1
BW50	50	1
BW63	63	1
BW75	75	1

Type CW to BS6121 (for outdoor or indoor application)



CODE	ENTRY THREAD SIZE mm	PACK SIZE
CW20S	20s	2
CW20	20	2
CW25	25	2
CW32	32	2
CW40	40	1
CW50	50	1
CW63	63	1
CW75	75	1

CABLE AND CONDUIT FITTINGS

Cable gland capacity

STEEL TAPE ARMoured				
PVC FLEXIBLE				
	SIZE mm ²	O.D. OVER ARMOUR mm	M20 PD427	M25 PD428
2 core	0.05	8.07		
	0,05	9.01		
	1.00	9.05		
	1.05	10.01	*	
	2.05	12.09		*
	4.00	14.06		*
3 core	0.05	9.01		
	0,05	9.05		
	1.00	10.00	*	
	1.05	10.07	*	
	2.05	13.06		*
	4.00	15.04		*
4 core	0.05	9.06		
	0,05	10.01	*	
	1.00	10.08	*	
	1.05	12.08		*
	2.05	14.06		*
	4.00	16.05		*
5 core	0.05	10.00	*	
	0,05	11.00	*	
	1.00	12.06		*
	1.05	13.05		*
	2.05	16.03		*
	4.00	18.01		*
6 core	0.05	10.08	*	
	0,05	12.08		*
	1.00	14.02		*
	1.05	15.06		*
	2.05	17.06		*
	4.00	19.06		*

The above table is a guide to the size of cable which can be correctly accommodated by Armoured Cable Glands and Cable Saddle Clamps shown on pages 128-129 of this catalogue.

NOTE: This chart is for guidance only; actual cable dimensions should be considered before making final selection as these may vary due to the manufacturing tolerance permitted.

This table relates to PD428 & PD429 shown on page 128 only.

CABLE AND CONDUIT FITTINGS

Armoured gland pack - selector table

NOMINAL CONDUCTOR AREA (mm ²)	NUMBER OF CORES (600/1000V)											
	1	2	3	4	5	7	10	12	19	27	37	48
1.05	-	20S	20S	20S	20S	20S	20	20	25	25	32	32
2.05	-	20S	20S	20S	20	20	25	25	25	32	40	40
4	-	20S	20S	20	20	20	25	25	32	40	-	-
6	-	20	20	20								
10	-	20	25	25								
16	-	25	25	25								
25	-	25	25	32								
35	-	25	32	32								
50	20	32	32	40								
70	25	32	40	40								
95	25	40	40	50/50S								
120	25	40	50/50S	50/50S								
150	32	50	50/50S	63								
185	32	50/50S	50	63/63S								
240	40	50	63/63S	63								
300	40	63/63S	63/63S	75/75S								
400	50	63/63S	75/75S	75								

The above information and Selector Chart relate to BW and CW Armoured Cable Glands shown on page 129 of this catalogue.

Glands manufactured to BS6121: Pt. 1: 1989 for use with PVC, SWA, PVC 600/1000V cables to BS 6346: 1989.

NOTE: This chart is for guidance only; actual cable dimensions should be considered before making final selection as these may vary due to the manufacturing tolerance permitted in BS 6346: 1989.

MAESTRO THE PLUG-IN CEILING ROSE



MAESTRO THE PLUG-IN CEILING ROSE

TECHNICAL INFORMATION

- A decorative plug in ceiling rose of durable die cast construction, designed to allow the user to detach luminaires quickly & safely for cleaning, maintenance, or renewal
- Manufactured to comply with BS6972
- 6A 230VAC maximum rating
- Available in a choice of four finishes including polished brass/ polished chrome/ matt black / gloss white
- The fixed section of the ceiling rose incorporates IP2X shrouded & finger proof contacts, thus eliminating the possibility of exposed live contacts when the slide section is detached
- The slide section is equipped with a cord grip to prevent strain on the terminal connections
- Insulated parts are manufactured from flame retardant materials
- It is possible to support luminaires from the ceiling rose using two different methods.
 1. Extremely lightweight luminaires can be suspended by a circular flexible cord alone. A grommet is provided for this
 2. An open ended suspension hook is suitable for use with luminaires weighing no more than 5Kg
- Suspension hooks are connected to the slide section of the ceiling rose via a 12.5mm thread
- Captive screw type brass terminal blocks are provided for connections to permanent live, switched live, neutral, & earth, in similar format to a conventional ceiling rose.
- Each screw termination can accept 2x 1.5mmsq conductors
- Cable access knockouts are provided in the base plate, & are offset from centre to prevent the need to cut ceiling joists



FINISH	CEILING MAESTRO	
	BUBBLE PACK	BOXED
POLISHED BRASS	MC11A	MB11A
CHROME	MC11C	MB11C
MATT BLACK	MC11D	MB11D
GLOSS WHITE	MC11E	MB11E

The Problem Solvers

Lewden Electrical Industries is an established manufacturer of custom build electrical power distribution products. Lewden guarantee our costumers a fast personalised service with quality components, producing custom designed equipment at competitive prices. We serve an impressive scope of industries, providing solutions to projects from the very simple to the most complex to meet the needs of you, the costumer.

A selection of the many solutions we have provided:



Custom Power Distribution Products:

- Endless bespoke design possibilities
- Selection of construction materials & finishes
- Suited to portable/temporary or fixed installations
- Vast project portfolio





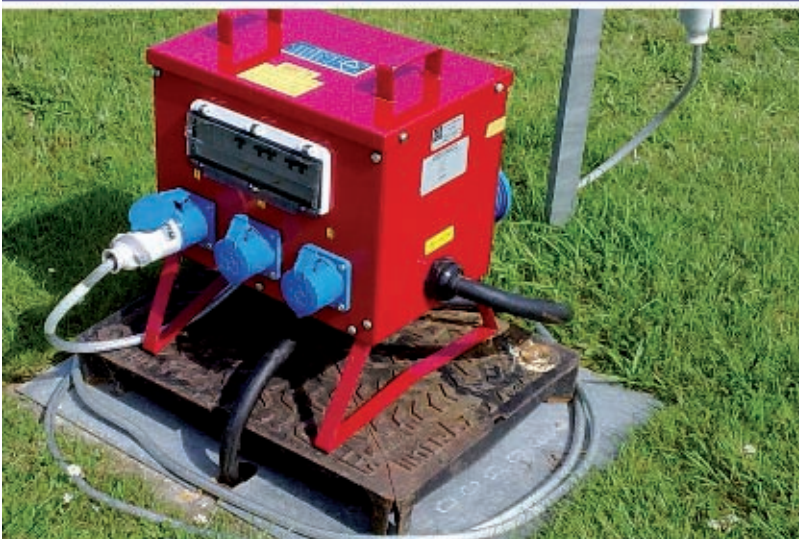

CODE	PAGE	CODE	PAGE	CODE	PAGE	CODE	PAGE	CODE	PAGE
101095	118	459322	28	471466	21	473313	18	477102	33
101096	118	459538	28	471467	29	473316	18	477103	33
112094	119	470126	50	471472	21	473317	18	477105	33
113094	119	470136	50	471473	29	473318	18	477106	33
113194	119	470146	50	471476	21	473323	18	477113	33
150006	115	470226	50	471477	29	473326	18	477115	33
150016	115	470236	50	471482	21	473327	18	477116	33
150026	115	470247	50	471483	29	473403	18	477203	17
159030	119	470326	50	471486	21	473406	18	477206	17
159032	119	470336	50	471487	29	473407	18	477207	17
159033	119	470346	50	471552	21	473413	18	477212	16
159034	119	471003	35	471553	29	473416	18	477213	17
159035	119	471005	34	471555	21	473423	18	477215	16
159036	119	471007	35	471556	29	473426	18	477216	17
159037	119	471015	34	471562	21	473486	57	477217	17
159040	119	471035	35	471563	29	473503	18	477218	17
159042	119	471045	35	471566	21	473506	18	477222	16
159043	119	471063	35	471567	29	473513	18	477223	17
159044	119	471067	35	471572	21	473516	18	477225	16
159045	119	471102	34	471573	29	473523	18	477226	17
159046	119	471103	35	471576	21	473526	18	477227	17
249538	17	471105	34	471577	29	473602	34	477228	17
249550	17	471107	35	471602	34	473603	34	477273	17
259538	17	471112	34	471605	34	473605	34	477303	17
346338	18	471113	35	471632	35	473606	34	477306	17
346350	18	471115	34	471635	35	474771	59	477307	17
349538	18	471117	35	472133	59	475202	16	477312	16
349550	18	471132	35	473002	34	475212	16	477313	17
356338	18	471135	35	473003	34	475222	16	477315	16
359538	18	471142	35	473005	34	475302	16	477316	17
431638	27	471145	35	473006	34	475312	16	477317	17
433238	27	471222	21	473062	34	475322	16	477318	17
436311	28	471223	29	473063	34	475402	16	477322	16
436322	28	471262	21	473065	34	475412	16	477323	17
436338	28	471263	29	473066	34	475422	16	477325	16
441611	27	471266	21	473102	34	476207	26	477326	17
441622	27	471267	29	473103	34	476217	26	477327	17
443211	27	471272	21	473105	34	476218	26	477328	17
443222	27	471273	29	473106	34	476227	26	477328	18
445338	23	471276	21	473112	34	476228	26	477402	16
446311	28	471277	29	473113	34	476307	26	477403	17
446322	28	471286	21	473115	34	476317	26	477405	16
446338	28	471287	29	473116	34	476318	26	477406	17
448538	23	471332	21	473203	18	476327	26	477407	17
449311	28	471333	29	473206	18	476328	26	477413	17
449322	28	471362	21	473207	18	476407	26	477416	17
449538	28	471363	29	473213	18	476486	58	477417	17
451611	27	471366	21	473216	18	476517	26	477423	17
451622	27	471367	29	473217	18	476905	30	477426	17
453211	27	471372	21	473218	18	476905	30	477427	17
453222	27	471373	29	473223	18	476913	30	477513	17
455338	23	471376	21	473226	18	476923	30	477516	17
456311	28	471377	29	473227	18	476925	30	477517	17
456322	28	471386	21	473228	18	477005	33	477523	17
456338	28	471387	29	473303	18	477006	33	477526	17
458538	23	471462	21	473306	18	477065	33	477538	17
459311	28	471463	29	473307	18	477066	33	477556	17

CODE	PAGE	CODE	PAGE	CODE	PAGE	CODE	PAGE	CODE	PAGE
477602	33	488114	74	489223	58	491249	68	511420	115
477603	33	488116	29	489224	28	492124	68	512204	116
477605	33	488116	74	489224	74	492126	68	512206	116
477606	33	488124	28	489226	28	492136	68	512211	116
480324	72	488124	74	489226	74	492146	68	515111	116
480326	72	488126	28	489229	28	492224	68	515112	116
480329	72	488126	74	489229	74	492226	68	515200	116
480334	72	488129	28	489233	74	492236	68	515214	116
480336	72	488129	74	489234	28	492246	68	515221	116
480339	72	488134	28	489234	74	497124	48	515224	116
480344	72	488134	74	489236	28	497126	48	515300	116
480346	72	488136	28	489236	74	497129	48	515313	116
480349	72	488136	74	489239	28	497134	48	515323	116
481324	72	488139	28	489239	74	497136	48	515423	116
481326	72	488139	74	489244	28	497139	48	521210	115
481329	72	488144	28	489244	74	497144	48	525200	116
481334	72	488144	74	489246	28	497146	48	530001	110
481336	72	488146	28	489246	74	497149	48	530002	110
481339	72	488146	74	489249	28	497224	48	530003	110
481344	72	488149	28	489249	74	497226	48	530004	110
481346	72	488149	74	490024	69	497229	48	530005	110
481349	72	488224	28	490124	69	497234	48	530006	110
485129	24	488224	74	490126	69	497236	48	530007	110
485134	24	488226	28	490129	69	497239	48	530031	110
485136	24	488226	74	490134	69	497244	48	530032	110
485139	24	488229	28	490136	69	497246	48	530033	110
485144	24	488229	74	490139	69	497249	48	530034	110
485146	24	488234	28	490144	69	499126	69	530035	110
485149	24	488234	74	490146	69	499136	69	530036	110
485224	24	488236	28	490149	69	499146	69	530037	110
485226	24	488236	74	490224	69	499226	69	530501	111
485229	24	488239	28	490226	69	499236	69	530502	111
485234	24	488239	74	490229	69	499246	69	530503	111
485236	24	488244	28	490234	69	508124	22	530504	111
485239	24	488244	74	490236	69	508126	22	530505	111
485244	24	488246	28	490239	69	508136	22	530506	111
485246	24	488246	74	490244	69	508146	22	530520	110
485249	24	488249	28	490246	69	508224	22	530521	110
487124	24	488249	74	490249	69	508226	22	530521	110
487126	24	489124	28	491124	68	508236	22	530522	110
487129	24	489124	74	491126	68	508246	22	530523	110
487134	24	489126	28	491129	68	509124	22	530524	110
487136	24	489126	74	491134	68	509126	22	530540	110
487139	24	489129	28	491136	68	509136	22	530541	110
487144	24	489129	74	491139	68	509146	22	530541	110
487146	24	489134	28	491144	68	509224	22	530542	110
487149	24	489134	74	491146	68	509226	22	530543	110
487224	24	489136	28	491149	68	509236	22	530544	110
487226	24	489136	74	491224	68	509246	22	530550	111
487229	24	489139	28	491226	68	509326	22	530551	111
487234	24	489139	74	491229	68	509336	22	530551	111
487236	24	489144	28	491233	68	509346	22	530552	111
487239	24	489144	74	491234	68	511110	115	530553	111
487244	24	489146	28	491236	68	511210	115	530554	111
487246	24	489146	74	491239	68	511220	115	530560	111
487249	24	489149	28	491244	68	511310	115	530561	111
488114	29	489149	74	491246	68	511320	115	530562	111

CODE	PAGE	CODE	PAGE	CODE	PAGE	CODE	PAGE	CODE	PAGE
530562	111	532055	113	559538	29	579831	77	710224	14
530563	111	532116	113	570010	77	579832	77	710226	14
530564	111	532117	113	575506	112	579840	75	710236	14
530580	111	532118	113	575701	104	579842	75	710246	14
530581	111	532200	113	575702	104	579844	77	710326	14
530581	111	532201	113	575706	105	579845	77	710336	14
530582	111	532202	113	575708	105	579847	78	710346	14
530583	111	532203	113	575710	104	579850	76	720120	39
530584	111	532204	113	575711	104	579855	76	720122	39
530601	111	532211	113	576100	102	580250	76	720129	15
530602	111	532300	113	576101	102	630001	81	720130	39
530603	111	532301	113	576110	102	630002	81	720132	39
530604	111	532302	113	576111	102	630003	81	720134	15
530605	111	532303	113	576112	102	630011	81	720139	15
530606	111	532304	113	576113	102	630012	81	720140	39
530607	111	532705	114	576200	103	630013	81	720142	39
530621	111	532714	114	576201	103	630021	81	720144	15
530622	111	532715	114	576202	103	630022	81	720149	15
530623	111	532716	114	576203	103	630030	80	720229	15
530624	111	532717	114	576205	103	630031	80	720234	15
530625	111	532718	114	576206	103	630035	80	720239	15
530626	111	532725	117	576400	103	630040	80	720244	15
530640	111	532735	117	576401	103	630041	80	720249	15
530640	111	532745	117	576600	104	630042	80	730124	15
530640	111	532747	117	576601	104	630051	78	730126	15
530640	111	532748	117	576800	103	630053	78	730136	15
530640	111	532755	117	579011	77	630055	79	730146	15
530640	111	532765	117	579012	76	630056	79	730224	15
530640	111	532768	117	579013	76	630057	79	730226	15
530641	111	536311	29	579400	73	630080	79	730236	15
530641	111	536322	29	579421	71	630081	79	730246	15
530641	111	536338	29	579421	73	630090	80	730326	15
530641	111	538005	114	579452	71	700120	39	730336	15
530641	111	538006	114	579453	71	700122	39	730346	15
530641	111	538015	114	579612	112	700129	14	740001	32
530641	111	538016	114	579631	73	700132	39	740003	32
530660	111	538017	114	579700	48	700134	14	745338	20
530660	111	538018	114	579708	112	700139	14	746338	26
530660	111	538035	114	579709	112	700140	39	748538	20
530660	111	538045	114	579710	59	700142	39	749538	26
530660	111	538055	114	579710	70	700144	14	749550	26
530660	111	538116	114	579711	70	700149	14	752126	32
530680	111	538117	114	579712	70	700220	39	752136	32
530680	111	538118	114	579713	71	700222	39	752146	32
530680	111	546311	29	579714	71	700229	14	753126	32
530680	111	546322	29	579720	49	700230	39	753136	32
530680	111	546338	29	579721	71	700232	39	753146	32
530680	111	546350	29	579722	71	700234	14	753236	32
530680	111	549311	29	579723	71	700239	14	755338	20
532005	114	549322	29	579741	70	700240	39	756338	26
532006	114	549538	29	579742	70	700242	39	759538	26
532015	114	549550	29	579743	70	700244	14	791910	112
532016	114	556311	29	579744	70	700249	14	791911	118
532017	114	556322	29	579824	75	710124	14	791920	112
532018	114	556338	29	579826	75	710126	14	791930	112
532035	113	559311	29	579828	75	710136	14	791931	118
532045	113	559322	29	579830	77	710146	14	791940	112

CODE	PAGE	CODE	PAGE	CODE	PAGE	CODE	PAGE	CODE	PAGE
791941	118	ISO-63	95	PD173NP	90	PD330/411N	43	PDSQ160/3SAM	87
791950	112	M324P	96	PD213/3PAM	87	PD330/416N	42	PDSQ219/2AM	90
791951	118	MB11A	133	PD213/3SAM	87	PD330/417N	43	PDSQ219AM	90
791960	112	MB11C	133	PD219/2AM	90	PD330/430N	42	PDSWT1366/4	89
791961	117	MB11D	133	PD219/2NP	90	PD330/431N	43	PDSWT1366/6	89
791971	117	MB11E	133	PD229/2AM	90	PD330/432N	42	PM100/208/3FPB	94
891124	49	MC11A	133	PD229/2NP	90	PD330/433N	43	PM100/208/4FPB	94
891126	49	MC11C	133	PD229AM	90	PD330/438N	42	PM125/3405	46
891129	49	MC11D	133	PD229N	90	PD330/439N	43	PM125/3408	46
891134	49	MC11E	133	PD230PAM	88	PD330/440N	42	PM125/345NPC	30
891136	49	MO3346	91	PD230PN	88	PD330/441N	43	PM125/601	17
891139	49	MO5023	55	PD230SAM	88	PD331/263N	43	PM125/605	17
891144	49	MO5965	91	PD230SN	88	PD331/264N	43	PM125/608	17
891146	49	MS15U	101	PD236K	90	PD331/269N	42	PM125/640	23
891149	49	MSF100	97	PD236NP	90	PD331/270N	42	PM125/641	23
891224	49	MSF100(CD)	97	PD292	127	PD331/275N	42	PM125/642	23
891226	49	PD125/305FPB	51	PD293	127	PD331/276N	42	PM125/643	23
891229	49	PD125/311FPB	51	PD30/3PAM	88	PD331/278N	43	PM125/644	23
891234	49	PD1307A	128	PD30/3SAM	88	PD331/279N	43	PM125/645	23
891236	49	PD1322SAM	86	PD30/4PAM	88	PD331/326N	43	PM125/646	23
891239	49	PD1322SN	86	PD30/4SAM	88	PD331/328N	42	PM125/647	23
891244	49	PD1327N	86	PD319AM	90	PD331/330N	42	PM125/648	23
891246	49	PD1327N	86	PD319NP	90	PD331/331N	43	PM125/741N	20
891249	49	PD1327PAM	85	PD32/100	41	PD411	127	PM125/748FPB	20
472027RCD	55	PD1327PN	85	PD32/101	41	PD427	128	PM125/751	26
472137RCD	55	PD1327SAM	86	PD32/105	41	PD428	128	PM125/755	26
472623RCD	55	PD1366/45SWT-NEON	89	PD32/108	41	PD429	128	PM125/758	26
472624RCD	55	PD1366DS	89	PD32/120	41	PD435	128	PM125/801	18
472647RCD	55	PD1366DS-NEON	89	PD32/121	41	PD63/305FPB	51	PM125/805	18
472733RCD	55	PD1383NN	91	PD32/125	41	PD63/311FPB	51	PM125/808	18
472734RCD	55	PD145/2K	90	PD32/128	41	PD84/3PAM	87	PM16/1000FPB	14
472843RCD	55	PD145/2NP	90	PD32/301FPB	51	PD84/3SAM	87	PM16/1100FPB	14
472844RCD	55	PD145/K	90	PD32/305FPB	51	PD84/4PAM	87	PM16/1500FPB	14
BW20	129	PD145/NP	90	PD32/311FPB	51	PD84/4SAM	87	PM16/1800FPB	14
BW20S	129	PD1452A	128	PD329AM	90	PD84/5PAM	87	PM16/2000FPB	15
BW25	129	PD1452B	128	PD329NP	90	PD84/5SAM	87	PM16/208/2FPB	94
BW32	129	PD16/100	41	PD330/155N	42	PD930/3PAM	87	PM16/208/3FPB	94
BW40	129	PD16/101	41	PD330/156N	43	PD930/3PAM	87	PM16/208/4FPB	94
BW50	129	PD16/105	41	PD330/157N	42	PD930/3PAM	87	PM16/2100FPB	15
BW63	129	PD16/108	41	PD330/158N	43	PD930/3SAM	87	PM16/2500FPB	15
BW75	129	PD16/120	41	PD330/159N	42	PD930/3SAM	87	PM16/2800FPB	15
CW20	129	PD16/121	41	PD330/160N	43	PD930/3SAM	87	PM16/3000FPB	27
CW20S	129	PD16/125	41	PD330/223N	43	PD930/4PAM	87	PM16/3100FPB	27
CW25	129	PD16/128	41	PD330/224N	42	PD930/4PAM	87	PM16/3300NFPB	47
CW32	129	PD16/300FPB	51	PD330/343N	42	PD930/4PAM	87	PM16/3301NFPB	47
CW40	129	PD16/301FPB	51	PD330/344N	43	PD930/4SAM	87	PM16/3305NFPB	47
CW50	129	PD16/305FPB	51	PD330/345N	42	PD930/4SAM	87	PM16/3308NFPB	47
CW63	129	PD16/311FPB	51	PD330/346N	43	PD930/4SAM	87	PM16/3400	46
CW75	129	PD160/3PAM	87	PD330/351N	42	PD998BPAM	88	PM16/3400NFPB	47
FS1253P	97	PD160/3SAM	87	PD330/352N	43	PD998HBSAM	88	PM16/3401	46
FS323P	97	PD160/4BPAM	87	PD330/353N	42	PD999PAM	88	PM16/3401NFPB	47
FS803P	97	PD160/4BSAM	87	PD330/354N	43	PD999SAM	88	PM16/3405	46
GRP-302514	120	PD160/5PAM	87	PD330/355N	42	PDRCD1366DS	89	PM16/3405NFPB	47
GRP-403020	120	PD160/5SAM	87	PD330/356N	43	PDSQ1322SAM	86	PM16/3408	46
GRP-504020	120	PD173/2K	90	PD330/408N	42	PDSQ145/2AM	90	PM16/3408NFPB	47
ISO-20	95	PD173/2NP	90	PD330/409N	43	PDSQ145AM	90	PM16/3500FPB	27
ISO-35	95	PD173K	90	PD330/410N	42	PDSQ160/3PAM	87	PM16/3800FPB	27

CODE	PAGE	CODE	PAGE	CODE	PAGE	CODE	PAGE	CODE	PAGE
PM16/3KC	30	PM16/963	35	PM32/72240	37	PM63/755	26	PMRCD32/408C	53
PM16/3NPCFPB	30	PM16/964	35	PM32/72415	37	PM63/758	26	PMRCD32/408SINFPB	55
PM16/4KC	30	PM16/965	40	PM32/740	20	PM63/801	18	PMRCD32/408SITT	54
PM16/500FPB	16	PM16/971	40	PM32/741	20	PM63/805	18	PMRCD63/401C	53
PM16/501FPB	16	PM16/975	40	PM32/745	20	PM63/808	18	PMRCD63/401SINFPB	55
PM16/505FPB	16	PM16/A110T	31	PM32/748	20	PMB16/3000/2N	125	PMRCD63/405C	53
PM16/508FPB	16	PM16/A130N	31	PM32/75240	37	PMB16/3000/3N	125	PMRCD63/405SINFPB	55
PM16/530FPB	24	PM16/A131N	31	PM32/75415	37	PMB16/3000/4N	125	PMRCD63/408C	53
PM16/531FPB	24	PM16/A24T	31	PM32/77415	38	PMB16/3100/2N	125	PMRCD63/408SINFPB	55
PM16/540N	21	PM25/208/3FPB	94	PM32/780	19	PMB16/3100/3N	125	PMXCD16/400SINFPB	50
PM16/541N	21	PM25/208/4FPB	94	PM32/781	19	PMB16/3100/4N	125	PMXCD16/401SINFPB	50
PM16/545	21	PM32/1000FPB	14	PM32/785N	19	PMB360	123	PMXCD16/405SINFPB	50
PM16/548	21	PM32/1100FPB	14	PM32/788N	19	PMRCBO16/16-1	100	PMXCD16/408SINFPB	50
PM16/5KC	30	PM32/1500FPB	14	PM32/790	25	PMRCBO16/16-1M	100	PMXCD32/400SINFPB	50
PM16/660	27	PM32/1800FPB	14	PM32/791	25	PMRCBO16/16-2	100	PMXCD32/401SINFPB	50
PM16/661	27	PM32/2000FPB	15	PM32/795	25	PMRCBO16/16-2M	100	PMXCD32/405SINFPB	50
PM16/665	27	PM32/208/2FPB	94	PM32/798	25	PMRCBO16/16-3	101	PMXCD32/408SINFPB	50
PM16/668	27	PM32/208/3FPB	94	PM32/81415	36	PMRCBO16/16-3M	101	PMXCD63/401SINFPB	50
PM16/71240	36	PM32/208/4FPB	94	PM32/82415	37	PMRCBO16/16-4	101	PMXCD63/405SINFPB	50
PM16/71415	36	PM32/2100FPB	15	PM32/85415	38	PMRCBO16/16-4M	101	PMXCD63/408SINFPB	50
PM16/72240	37	PM32/2500FPB	15	PM32/87415	38	PMRCBO32/32-1M	100	PRB10	123
PM16/72415	37	PM32/2800FPB	15	PM32/905	33	PMRCD16/300N	53	PRB12L	123
PM16/740	20	PM32/3000FPB	27	PM32/915	34	PMRCD16/300SITT	54	PRB12S	123
PM16/741	20	PM32/3100FPB	27	PM32/935	34	PMRCD16/301N	53	PRB22	124
PM16/745	20	PM32/3300NFPB	47	PM32/960	35	PMRCD16/301SITT	54	PRB230	124
PM16/748	20	PM32/3301NFPB	47	PM32/961	40	PMRCD16/305C	53	PRB231	124
PM16/75240	37	PM32/3305NFPB	47	PM32/962	35	PMRCD16/305SITT	54	PRB5010	124
PM16/75415	37	PM32/3308NFPB	47	PM32/963	35	PMRCD16/308C	53	PRB5412	124
PM16/77415	38	PM32/3400	46	PM32/964	35	PMRCD16/308SITT	54	PRB570	124
PM16/780	19	PM32/3401	46	PM32/965	40	PMRCD16/400C	53	R-16A/4P	95
PM16/781	19	PM32/3401NFPB	47	PM32/971	40	PMRCD16/400SITT	54	R-25A/4P	95
PM16/785N	19	PM32/3405	46	PM32/975	40	PMRCD16/401C	53	R-32A/4P	95
PM16/788N	19	PM32/3405NFPB	47	PM40/208/3FPB	94	PMRCD16/401SINFPB	55	R-40A/4P	95
PM16/790	25	PM32/3405RC	59	PM40/208/4FPB	94	PMRCD16/401SITT	54	R-63A/4P	95
PM16/791	25	PM32/3408	46	PM560C7W	62	PMRCD16/405C	53	S1003P	96
PM16/795	25	PM32/3408NFPB	47	PM560P7W	62	PMRCD16/405SINFPB	55	S1253P	96
PM16/798	25	PM32/3500FPB	27	PM63/208/2FPB	94	PMRCD16/405SITT	54	S2503P	96
PM16/81415	36	PM32/3800FPB	27	PM63/208/3FPB	94	PMRCD16/408C	53	S323P	96
PM16/82415	37	PM32/3KC	30	PM63/208/4FPB	94	PMRCD16/408SINFPB	55	S633P	96
PM16/85415	38	PM32/4KC	30	PM63/3400	46	PMRCD16/408SITT	54	SSE-2525/150	122
PM16/87415	38	PM32/500FPB	16	PM63/3401	46	PMRCD32/300C	53	SSE-3025/200	122
PM16/900FPB	33	PM32/501FPB	16	PM63/3401FPB	47	PMRCD32/300SITT	54	SSE-33/150	122
PM16/903FPB	33	PM32/505FPB	16	PM63/3405	46	PMRCD32/301C	53	SSE-43/150	122
PM16/904FPB	33	PM32/508FPB	16	PM63/3405FPB	47	PMRCD32/301SITT	54	SSE-44/200	122
PM16/905	33	PM32/540	21	PM63/3408	46	PMRCD32/305C	53	SSE-54/200	122
PM16/915	34	PM32/541	21	PM63/3408FPB	47	PMRCD32/305SITT	54	WME-3025/200	121
PM16/920FPB	35	PM32/545	21	PM63/345NPC	30	PMRCD32/308C	53	WME-33/150	121
PM16/923FPB	35	PM32/548	21	PM63/601	17	PMRCD32/308SITT	54	WME-43/150	121
PM16/930FPB	34	PM32/5KC	30	PM63/605	17	PMRCD32/400C	53	WME-44/200	121
PM16/933FPB	34	PM32/605RCFPB	57	PM63/608	17	PMRCD32/400SITT	54	WME-54/150	121
PM16/935	34	PM32/645/RCFPB	58	PM63/641	23	PMRCD32/401C	53	WME-54/200	121
PM16/940FPB	33	PM32/660	27	PM63/645	23	PMRCD32/401SINFPB	55	WME-64/200	121
PM16/941FPB	39	PM32/661	27	PM63/648	23	PMRCD32/401SITT	54	WME-65/200	121
PM16/943FPB	33	PM32/665	27	PM63/741N	20	PMRCD32/405/SI/RC	59	WME-66/200	121
PM16/960	35	PM32/668	27	PM63/745N	20	PMRCD32/405C	53	WME-75/200	121
PM16/961	40	PM32/71240	36	PM63/748N	20	PMRCD32/405SINFPB	55	WME-KL	121
PM16/962	35	PM32/71415	36	PM63/751	26	PMRCD32/405SITT	54	WME-WMK	121



Dealer's stamp



Argall Avenue, London E10 7QD - United Kingdom

UK Sales
 Tel: +44 (0)20 8539 0237
 Fax: +44 (0)20 8558 2718
 e-mail: sales@lewden.co.uk

Export Sales
 Tel: +44 (0)20 8988 7787
 Fax: +44 (0)20 8558 2001
 web: www.lewden.com