

AEC-Q101 Qualified Devices

LOAD DUMP PROTECTION TVS

Meets ISO16750-2 Requirements



3600W/4600W/6600W



Index

- *Why Load Dump Protection TVS Is Needed*
- *ISO16750-2 (2010) E Test A & B Method*
- *Key Parameters Of Load Dump TVS*
- *Operation Of Load Dump TVS*
- *PCB Layout Advice*
- *PANJIT DO-218AC Advantage*
- *PANJIT Load Dump Protection TVS Series*
- *ISO16750-2 (2010) E Test B*



Why Load Dump Protection TVS Is Needed

- Load dump TVS is an important protection device for automotive electrical module. It mainly protects the circuit by clamping down the surge voltage generated by the generator during load dump mode.
- When the battery of the automobile suddenly disconnect when the engine is running, the generator will causes an overshoot, which is called surge voltage. See the picture on the right.
- In order to assure the stability and reliability when the car is running, ECU needs to be anti-disturbance qualified. Currently, the automotive OEM refers to the following standards: **ISO7637-2-2004, ISO16750-2 2010(E), JASO and Toyota TC7001.**

* Pulse 5a/5b has been removed from the latest ISO7367-2(2010)

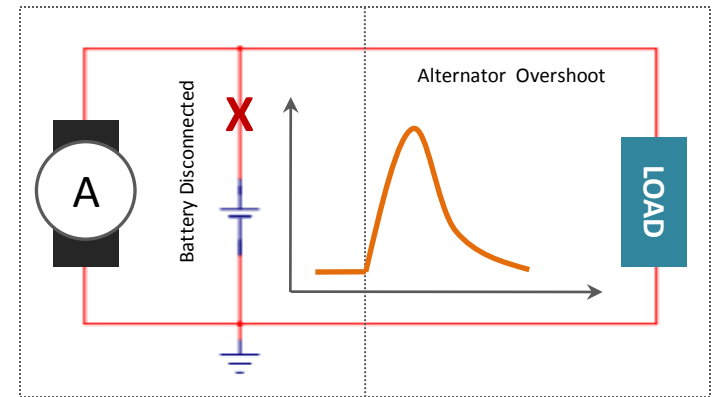

What is the Load Dump ?

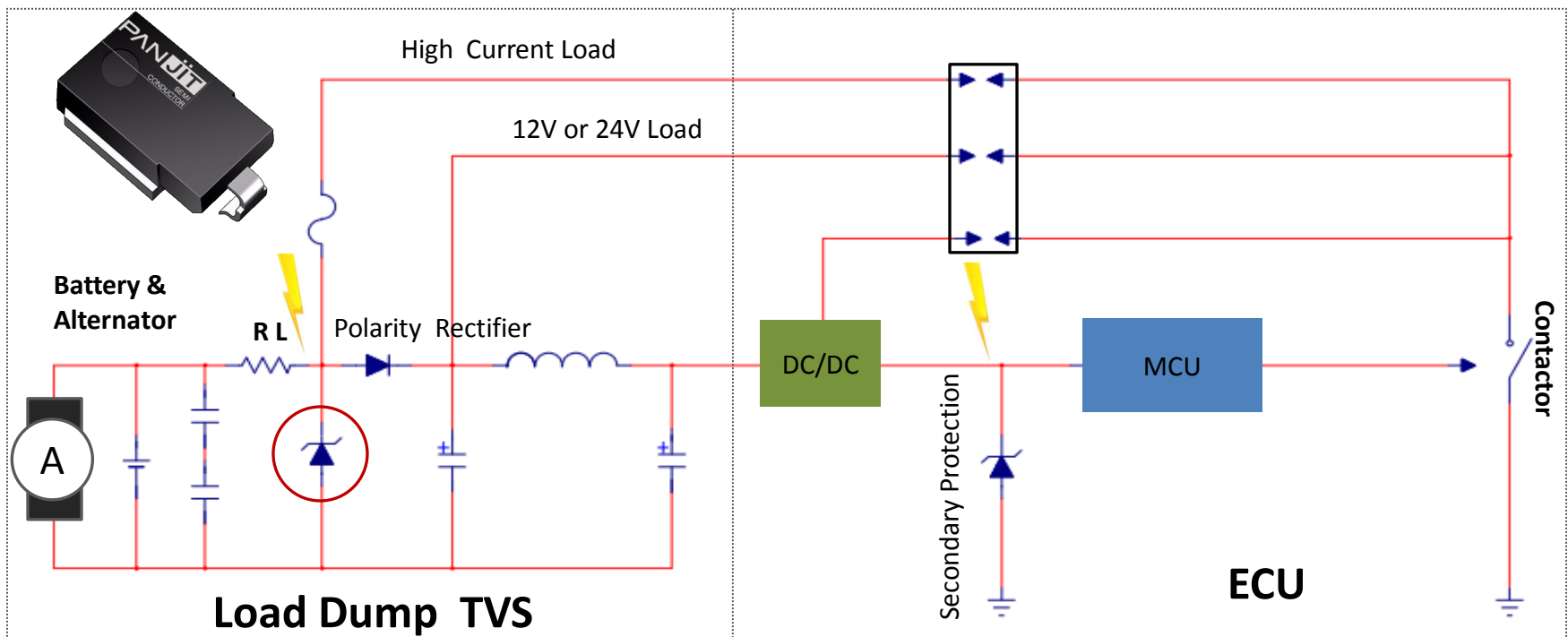

Parameter	Type of System		Mini. Test Requirements
	$U_N=12V$	$U_N=24V$	
U_S (V)	$79 \leq U_S \leq 101$	$151 \leq U_S \leq 202$	10 Pulses at intervals of 1min
R_i (Ω)	$0.5 \leq R_i \leq 4$	$1 \leq R_i \leq 8$	
T_d (mS)	$40 \leq U_S \leq 400$	$100 \leq U_S \leq 350$	
T_r (mS)	10 (+0/-5)	10 (+0/-5)	

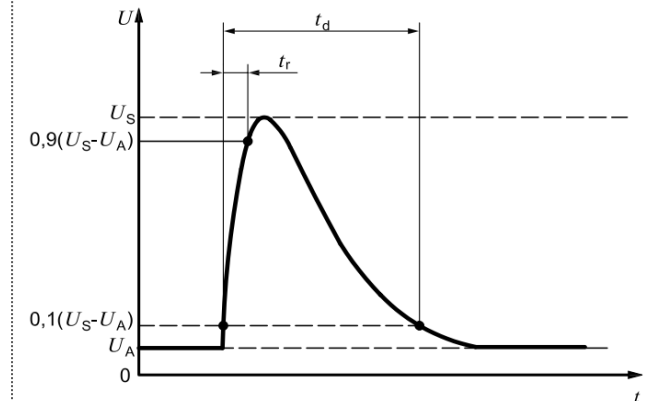

ISO16750-2 2010 Pulse of Test A

Parameter	Type of System		Mini. Test Requirements
	$U_N=12V$	$U_N=24V$	
U_S (V)	$79 \leq U_S \leq 101$	$151 \leq U_S \leq 202$	5 Pulses at intervals of 1min
U_S^* (V)	35	65	
R_i (Ω)	$0.5 \leq R_i \leq 4$	$1 \leq R_i \leq 8$	
T_d (mS)	$40 \leq U_S \leq 400$	$100 \leq U_S \leq 350$	
T_r (mS)	10 (+0/-5)	10 (+0/-5)	

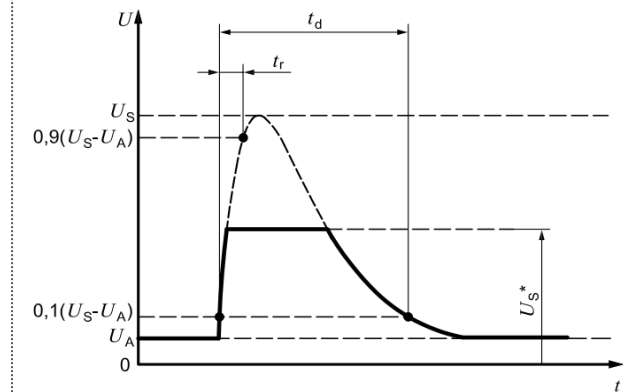

ISO16750-2 2010 Pulse of Test B

- New test condition for Non-Central Load Dump Type Alternator Equipped Vehicles
- Replaced ISO7637-2 Pulse 5a
- Requires High Power load Dump Protection Device For Clamping Large Current
- Clamping Current is as: $I_{clamping} = (U_S - V_{clamping}) / R_i$

• Clamping Voltage

Load Dump TVS needs to sustain the surge impact and clamp the voltage at the same time, in order to protect the EUT from damage.

Maximum. input voltage of voltage regulators:

- Linear Type: 37V to 40V
- DC-DC Converter IC: 40V to 60V

Customer's Design Guide Line: 10% Margin Required.

• Stand-Off Voltage

The V_{RWM} of the TVS needs to be higher or equal to the working voltage of the EUT, to assure the TVS would not fail or generate higher current load dump. Hence the V_{RWM} is a critical parameter when selecting the load dump TVS.

- Load Dump TVS Recommend for 12V system: $V_{RWM}=22V\sim24V$
- Load Dump TVS Recommend for 24V system: $V_{RWM}=30V\sim36V$

• ISO16750-2 Test Voltage Definition

Nominal Voltage UN (V)	Test Voltage UA (V)
12	14
24	28

Operation of Load Dump TVS

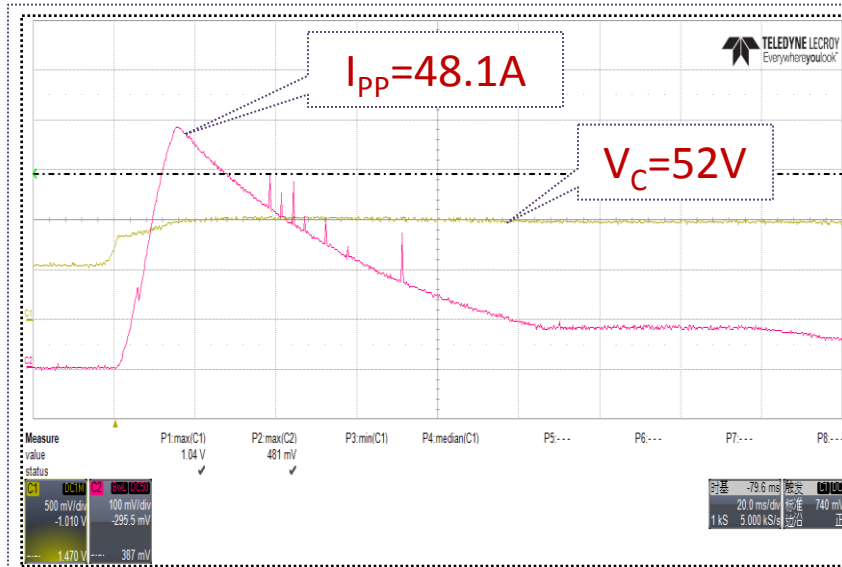
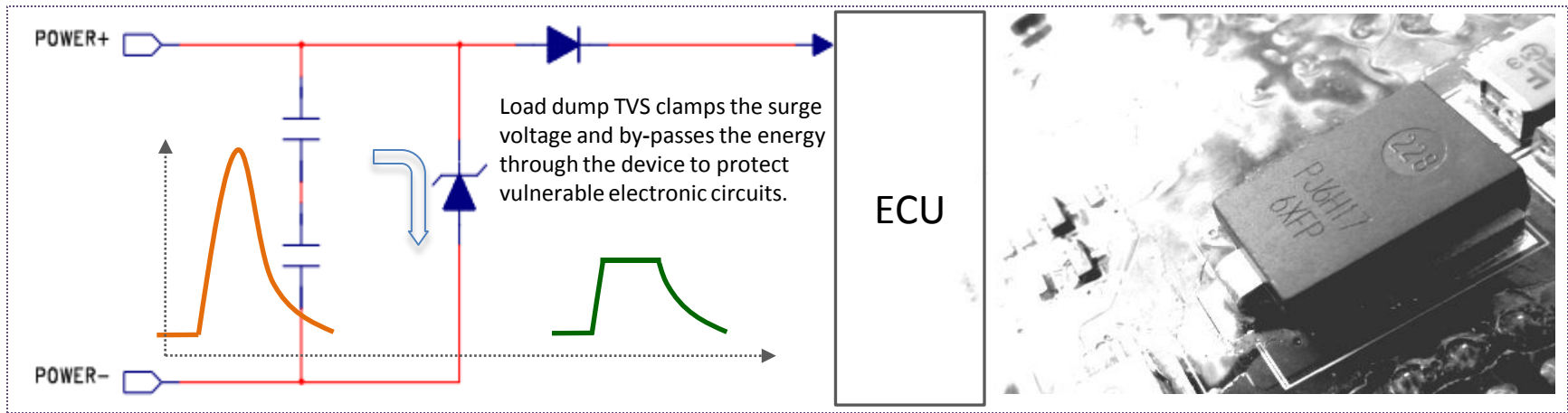

Test Rule: ISO16750-2 5a Test $R_i=3\Omega$

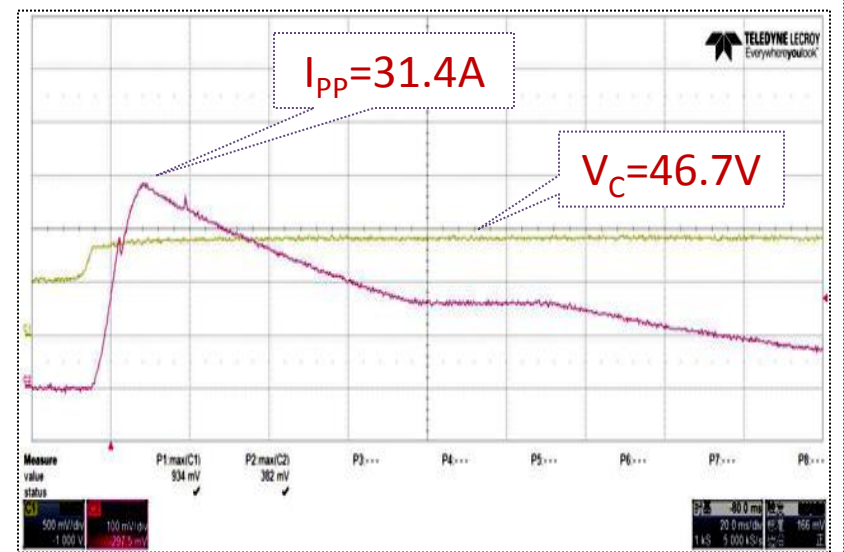

ISO16750-2 5a Test $R_i=8\Omega$

- TVS is suggested to be traced as close to the power input port as possible, because the inductance effect would be lower and the voltage clamping speed of the TVS would be faster.
- In the ECU, there are key components that need to be protected and the sensors that has bad surge sustainability. These devices should be traced as far to the load dump TVS and power input port as possible for decreasing the surge impact.
- The size of the pad layout on the PCB needs to match the heat sink of the DO-218AC package so the device could attach perfectly with the PCB after mounting. This could help reduce the thermal resistance between the TVS device and the PCB.
- When the load dump TVS clamps the voltage, it generates an energy, this energy then turns into thermal which dissipate through the PCB. Thus in order to improve the dissipation capability, it is suggest to efficiently utilize the PCB area.

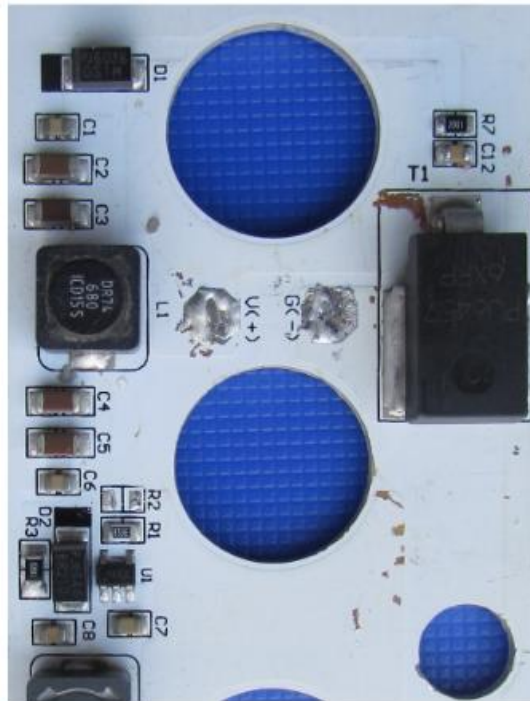

PANJIT uses automation vacuum soldering to assemble the DO-218AC package load dump TVS. Comparing with the traditional furnace soldering, automation vacuum soldering system helps reduce the soldering bias and void. The amount of the void effects the I_{pp} capability of the TVS, thus the lesser void on the die, the better IPP capability of the TVS; meanwhile the lower the thermal resistance is, the faster dissipation speed through thermal conduction.



PiNK® Void-Free Soldering System



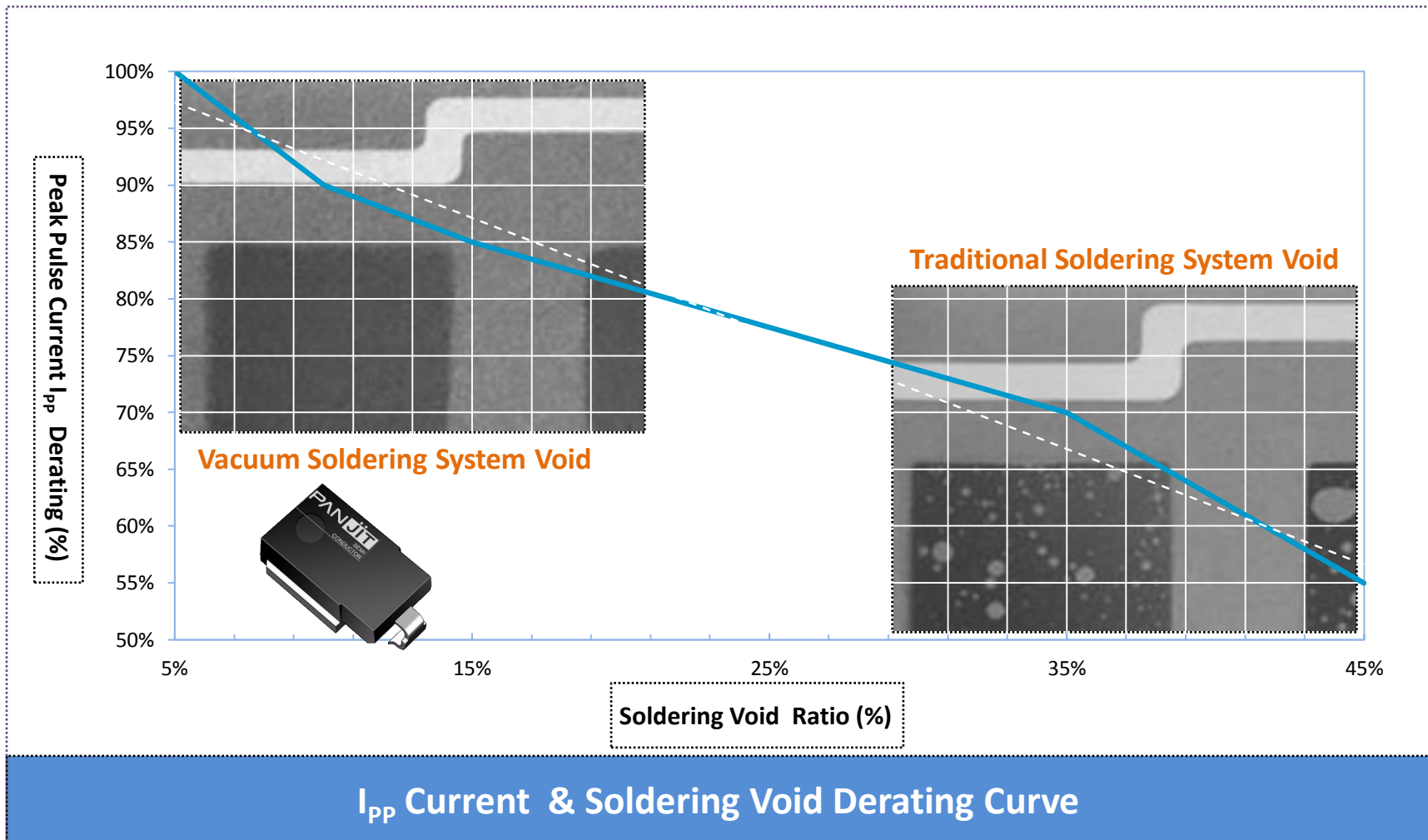

The soldering void is a key point for power TVS products, the amount of the void effects the surge current capability of the TVS

PANJIT Load Dump Protection TVS Series

PANJIT offers 3 series load dump TVS: 3.6KS/4.6KS/6.6KS, the highest power absorption is 3600W, 4600W, 6600W respectively and the V_{RWM} range is from 14V to 43V. These 3 series TVS are mainly for the load dump protection and 12V and 24V automotive.

Part Number	P_D (W)	V_{RWM} (V)	$V_{BR}@I_T$		I_T (mA)	$I_R@V_{RWM}$ (μ A)	$V_C@I_{PP}$ (V)	I_{PP} (A)	Application V_N (V)
			Min.	Max.					
3.6KSMJX14A-AU	3600	14	15.6	17.2	5	10	23.2	155	12
3.6KSMJX20A-AU	3600	20	22.2	24.5	5	10	32.4	111	12
3.6KSMJX22A-AU	3600	22	24.4	26.9	5	10	35.5	101	12
3.6KSMJX24A-AU	3600	24	26.7	29.5	5	10	38.9	93	12
3.6KSMJX33A-AU	3600	33	36.7	40.6	5	10	53.3	68	24
3.6KSMJX36A-AU	3600	36	40	44.2	5	10	58.1	62	24
4.6KSMJX14A-AU	4600	14	15.6	17.2	5	10	23.2	198	12
4.6KSMJX20A-AU	4600	20	22.2	24.5	5	10	32.4	142	12
4.6KSMJX22A-AU	4600	22	24.4	26.9	5	10	35.5	130	12
4.6KSMJX24A-AU	4600	24	26.7	29.5	5	10	38.9	118	12
4.6KSMJX33A-AU	4600	33	36.7	40.6	5	10	53.3	86	24
4.6KSMJX36A-AU	4600	36	40	44.2	5	10	58.1	79	24
6.6KSMJX14A-AU	6600	14	15.6	17.2	5	10	23.2	284	12
6.6KSMJX20A-AU	6600	20	22.2	24.5	5	10	32.4	204	12
6.6KSMJX22A-AU	6600	22	24.4	26.9	5	10	35.5	186	12
6.6KSMJX24A-AU	6600	24	26.7	29.5	5	10	38.9	170	12
6.6KSMJX33A-AU	6600	33	36.7	40.6	5	10	53.3	124	24
6.6KSMJX36A-AU	6600	36	40	44.2	5	10	58.1	114	24
6.6KSMJX43A-AU	6600	43	47.8	52.8	5	10	69.4	95	24

Notes: I_{PP} Test Pulse Waveform 10/1000 μ s

Parameter	Type of System		Mini. Test Requirements
	$U_N=12V$	$U_N=24V$	
U_S (V)	$79 \leq U_S \leq 101$	$151 \leq U_S \leq 202$	5 Pulses at intervals of 1min
U_S^* (V)	35	65	
R_i (Ω)	$0.5 \leq R_i \leq 4$	$1 \leq R_i \leq 8$	
T_d (mS)	$40 \leq U_S \leq 400$	$100 \leq U_S \leq 350$	
T_r (mS)	10 (+0/-5)	10 (+0/-5)	

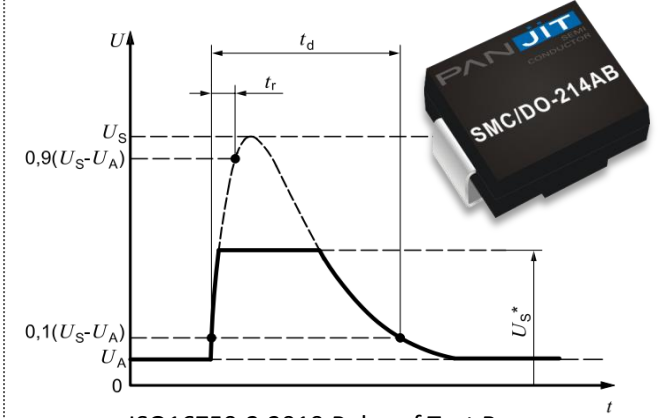

The testing voltage of ISO16750 Pulse B is 35% of the maximum polygonal voltage of Pulse A, thus the surge sustainability required for load Dump TVS is much lower. So for products that is tested based on ISO 16750 Pulse B, PANJIT recommends to use TVS assembled in SMC package (1.5KW/3.0KW/5KW).

Part Number	P_D (W)	V_{RWM} (V)	$V_{BR}@I_T$		I_T (mA)	$I_R@V_{RWM}$ (μ A)	$V_C@I_{PP}$ (V)	I_{PP} (A)	Application V_N (V)
			Min. (V)	Max. (V)					
1.5SMCJ22A-AU	1500	22	24.4	28	1	1	35.5	42.2	12
1.5SMJC24A-AU	1500	24	26.7	30.7	1	1	38.9	38.6	12
3.0SMCJ22A-AU	3000	22	24.4	28	1	1	35.5	74.4	12
3.0SMCJ24A-AU	3000	24	26.7	30.7	1	1	38.9	77.2	12
1.5SMCJ33A-AU	1500	33	36.7	42.2	1	1	53.3	28.1	24
1.5SMCJ36A-AU	1500	36	40	46	1	1	58.1	25.8	24
3.0SMCJ33A-AU	3000	33	36.7	42.2	1	1	53.3	56.2	24
3.0SMCJ36A-AU	3000	36	40	46	1	1	58.1	51.6	24
5.0SMCJ36A-AU	5000	36	40	46	1	1	58.1	86.1	24



Thanks for Your Attention
Your Component . Our Profession