



P-Channel 60-V (D-S) MOSFET

PRODUCT SUMMARY				
Part Number	$V_{(BR)DSS}$ Min (V)	$r_{DS(on)}$ Max (Ω)	$V_{GS(th)}$ (V)	I_D (A)
TP0610L	-60	10 @ $V_{GS} = -10$ V	-1 to -2.4	-0.18
TP0610T	-60	10 @ $V_{GS} = -10$ V	-1 to -2.4	-0.12
VP0610L	-60	10 @ $V_{GS} = -10$ V	-1 to -3.5	-0.18
VP0610T	-60	10 @ $V_{GS} = -10$ V	-1 to -3.5	-0.12
BS250	-45	14 @ $V_{GS} = -10$ V	-1 to -3.5	-0.18

FEATURES

- High-Side Switching
- Low On-Resistance: 8 Ω
- Low Threshold: -1.9 V
- Fast Switching Speed: 16 ns
- Low Input Capacitance: 15 pF

BENEFITS

- Ease in Driving Switches
- Low Offset (Error) Voltage
- Low-Voltage Operation
- High-Speed Switching
- Easily Driven Without Buffer

APPLICATIONS

- Drivers: Relays, Solenoids, Lamps, Hammers, Displays, Memories, Transistors, etc.
- Battery Operated Systems
- Power Supply, Converter Circuits
- Motor Control

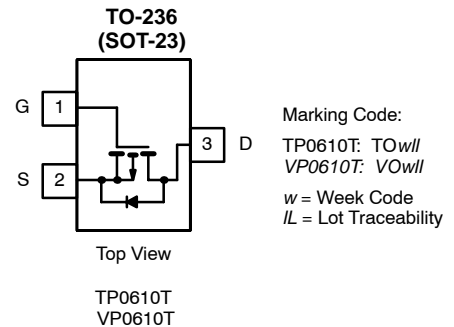
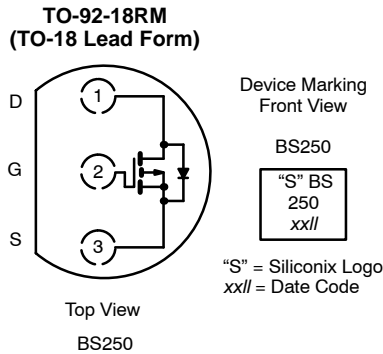
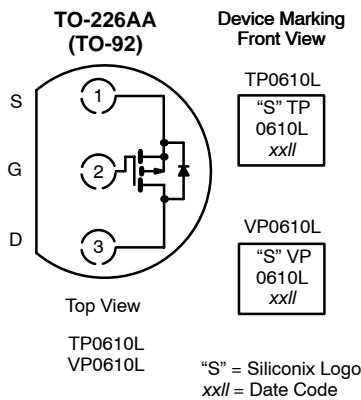

ABSOLUTE MAXIMUM RATINGS ($T_A = 25^\circ\text{C}$ UNLESS OTHERWISE NOTED)								
Parameter	Symbol	TP0610L	TP0610T	VP0610L	VP0610T	BS250	Unit	
Drain-Source Voltage	V_{DS}	-60	-60	-60	-60	-45	V	
Gate-Source Voltage	V_{GS}	± 30	± 30	± 30	± 30	± 25	V	
Continuous Drain Current ($T_J = 150^\circ\text{C}$)	$T_A = 25^\circ\text{C}$	-0.18	-0.12	-0.18	-0.12	-0.18	A	
	$T_A = 100^\circ\text{C}$	-0.11	-0.07	-0.11	-0.07			
Pulsed Drain Current ^a	I_{DM}	-0.8	-0.4	-0.8	-0.4		A	
Power Dissipation	$T_A = 25^\circ\text{C}$	0.8	0.36	0.8	0.36	0.83	W	
	$T_A = 100^\circ\text{C}$	0.32	0.14	0.32	0.14			
Thermal Resistance, Junction-to-Ambient	R_{thJA}	156	350	156	350	150	$^\circ\text{C}/\text{W}$	
Operating Junction and Storage Temperature Range	T_J, T_{stg}	-55 to 150						$^\circ\text{C}$

Notes

a. Pulse width limited by maximum junction temperature.

For applications information see AN804.



SPECIFICATIONS (T _A = 25 °C UNLESS OTHERWISE NOTED)										
Parameter	Symbol	Test Conditions	Typ ^a	Limits						Unit
				TP0610L/T		VP0610L/T		BS250		
				Min	Max	Min	Max	Min	Max	
Static										
Drain-Source Breakdown Voltage	V _{(BR)DSS}	V _{GS} = 0 V, I _D = -10 μA	-70	-60		-60				V
		V _{GS} = 0 V, I _D = -100 μA					-45			
Gate-Threshold Voltage	V _{GS(th)}	V _{DS} = V _{GS} , I _D = -1 mA	-1.9	-1	-2.4	-1	-3.5	-1	-3.5	
Gate-Body Leakage	I _{GSS}	V _{DS} = 0 V, V _{GS} = ±20 V			±10		±10			nA
		V _{DS} = 0 V, V _{GS} = ±20 V, T _J = 125 °C			±50					
		V _{DS} = 0 V, V _{GS} = ±15 V							±20	
Zero Gate Voltage Drain Current	I _{DSS}	V _{DS} = -48 V, V _{GS} = 0 V			-1		-1			μA
		V _{DS} = -48 V, V _{GS} = 0 V, T _J = 125 °C			-200		-200			
		V _{DS} = -25 V, V _{GS} = 0 V							-0.5	
On-State Drain Current ^b	I _{D(on)}	V _{DS} = -10 V, V _{GS} = -4.5 V	-180	-50						mA
		V _{DS} = -10 V, V _{GS} = -10 V	L Suffix	-750			-600			
			T Suffix				-220			
Drain-Source On-Resistance ^b	r _{DS(on)}	V _{GS} = -4.5 V, I _D = -25 mA	11		25					Ω
		V _{GS} = -10 V, I _D = -0.5 A	L Suffix	8		10		10		
			L Suffix	15		20		20		
		V _{GS} = -10 V, I _D = -0.2 A	T Suffix	6.5		10		10	14	
Forward Transconductance ^b	g _{fs}	V _{DS} = -10 V, I _D = -0.5 A	20	80						mS
		V _{DS} = -10 V, I _D = -0.1 A	90	60		70				
Diode Forward Voltage	V _{SD}	I _S = -0.5 A, V _{GS} = 0 V	-1.1							V
Dynamic										
Input Capacitance	C _{iss}	V _{DS} = -25 V, V _{GS} = 0 V f = 1 MHz	15		60		60			pF
Output Capacitance	C _{oss}		10		25		25			
Reverse Transfer Capacitance	C _{rss}		3		5		5			
Switching^c										
Turn-On Time	t _{ON}	V _{DD} = -25 V, R _L = 133 Ω I _D ≅ -0.18 A, V _{GEN} = -10 V, R _g = 25 Ω	8						10	ns
Turn-Off Time	t _{OFF}		8						10	

Notes

- a. For DESIGN AID ONLY, not subject to production testing.
- b. Pulse test: PW ≤ 300 μs duty cycle ≤ 2%.
- c. Switching time is essentially independent of operating temperature.

VPDS06



TYPICAL CHARACTERISTICS (25°C UNLESS NOTED)

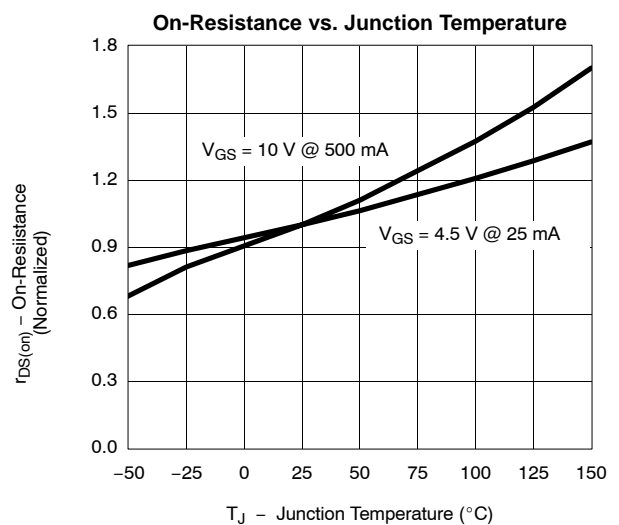
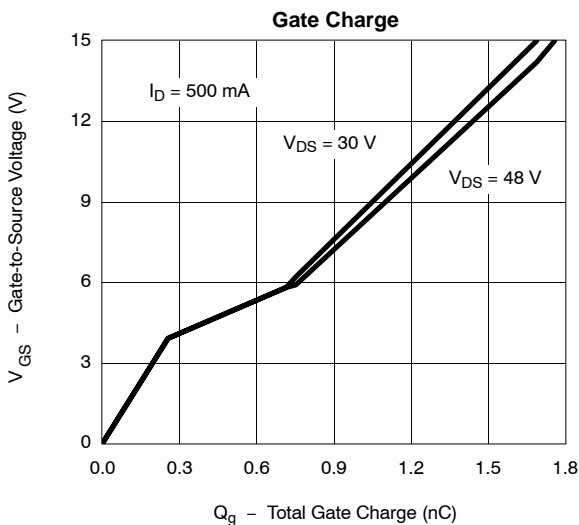
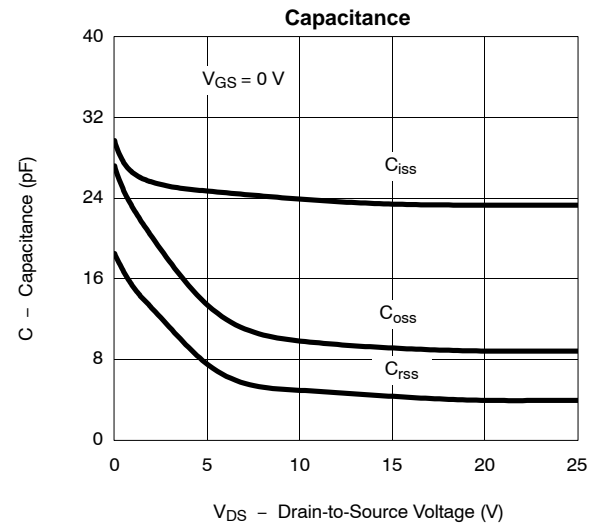
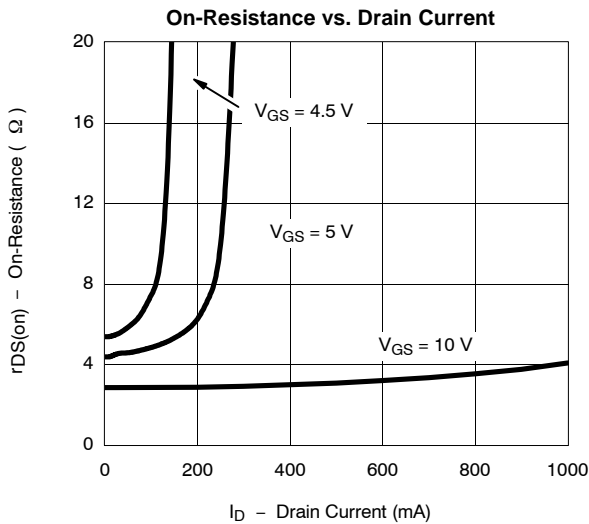
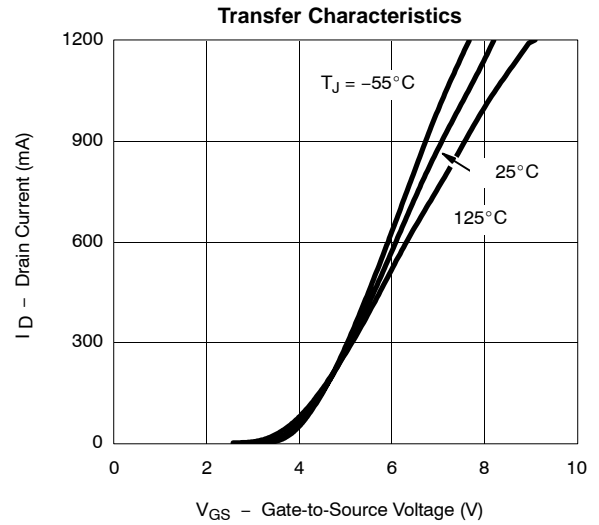
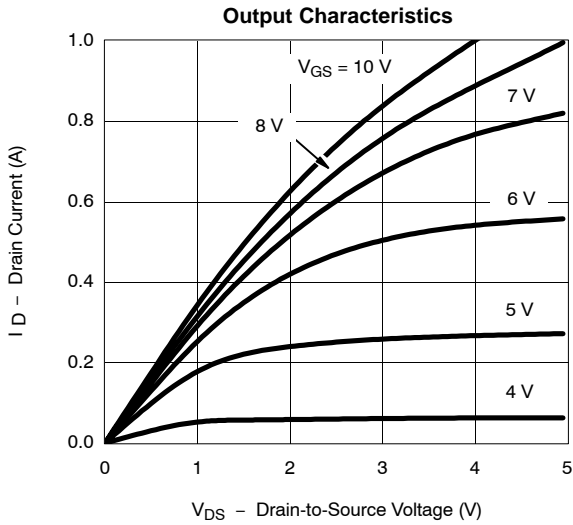

TYPICAL CHARACTERISTICS (25°C UNLESS NOTED)

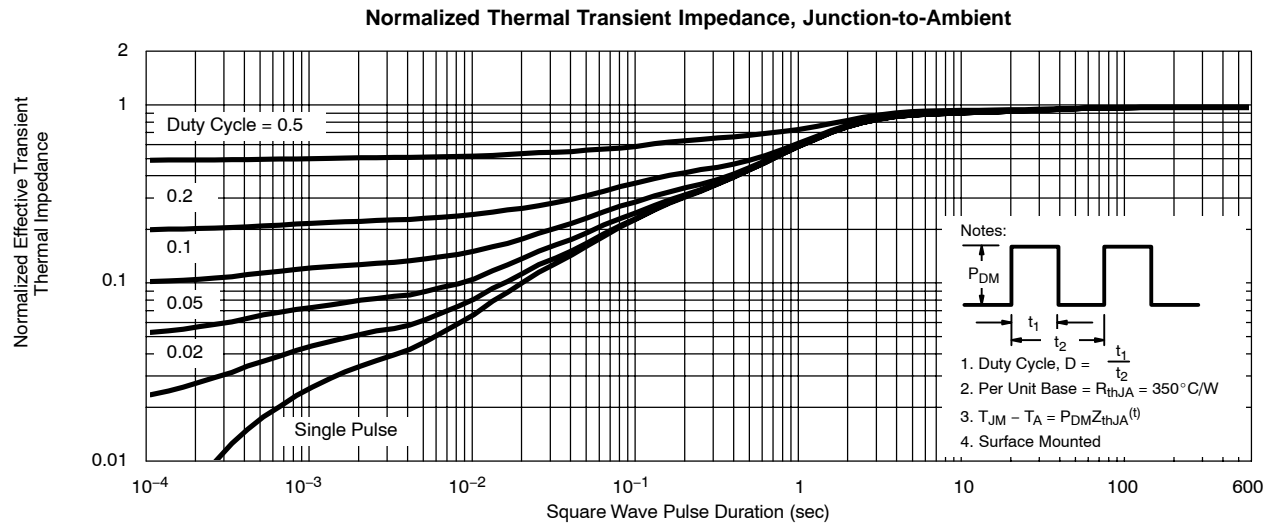
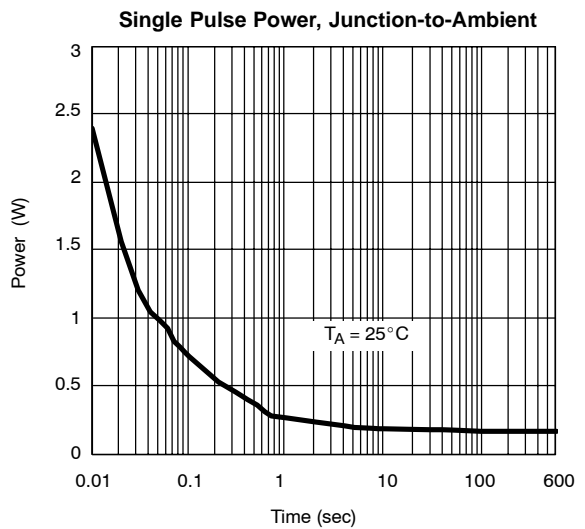
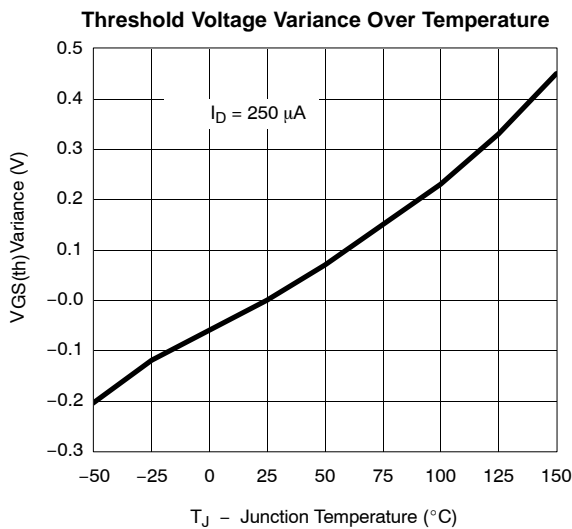
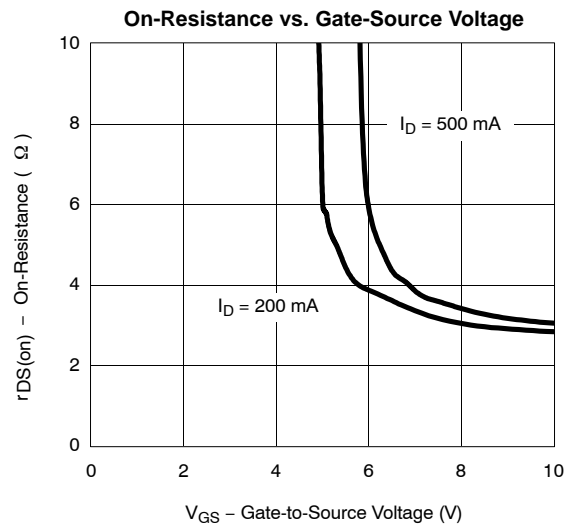
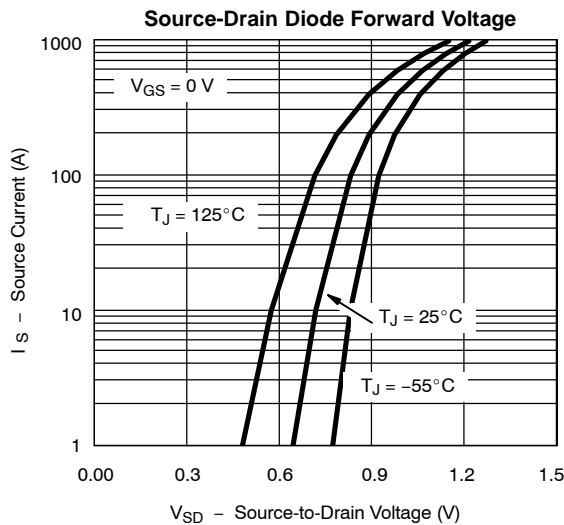



Disclaimer

All product specifications and data are subject to change without notice.

Vishay Intertechnology, Inc., its affiliates, agents, and employees, and all persons acting on its or their behalf (collectively, "Vishay"), disclaim any and all liability for any errors, inaccuracies or incompleteness contained herein or in any other disclosure relating to any product.

Vishay disclaims any and all liability arising out of the use or application of any product described herein or of any information provided herein to the maximum extent permitted by law. The product specifications do not expand or otherwise modify Vishay's terms and conditions of purchase, including but not limited to the warranty expressed therein, which apply to these products.

No license, express or implied, by estoppel or otherwise, to any intellectual property rights is granted by this document or by any conduct of Vishay.

The products shown herein are not designed for use in medical, life-saving, or life-sustaining applications unless otherwise expressly indicated. Customers using or selling Vishay products not expressly indicated for use in such applications do so entirely at their own risk and agree to fully indemnify Vishay for any damages arising or resulting from such use or sale. Please contact authorized Vishay personnel to obtain written terms and conditions regarding products designed for such applications.

Product names and markings noted herein may be trademarks of their respective owners.