

SECTION A-A

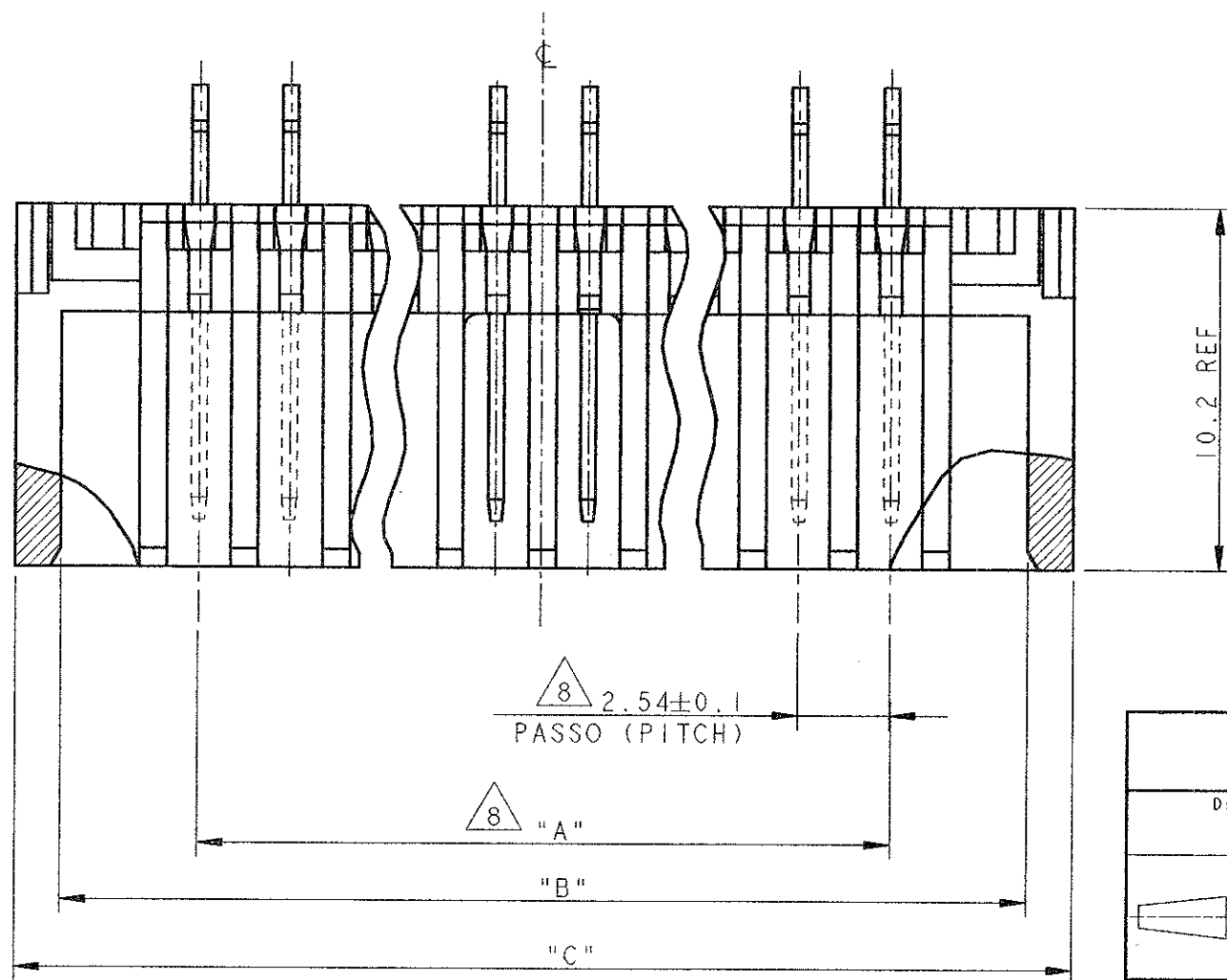
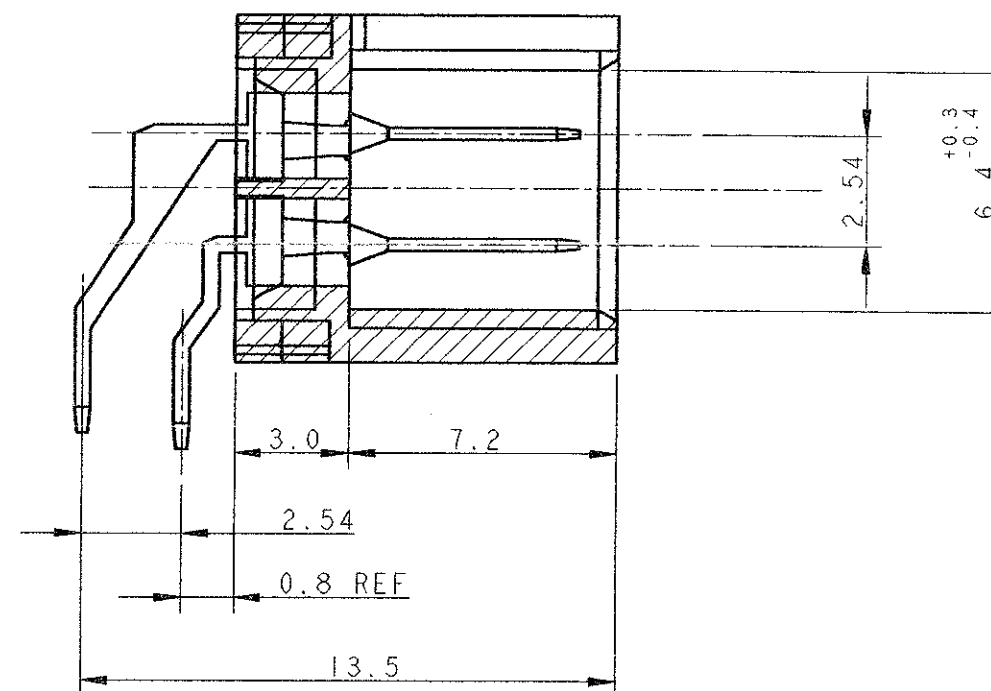
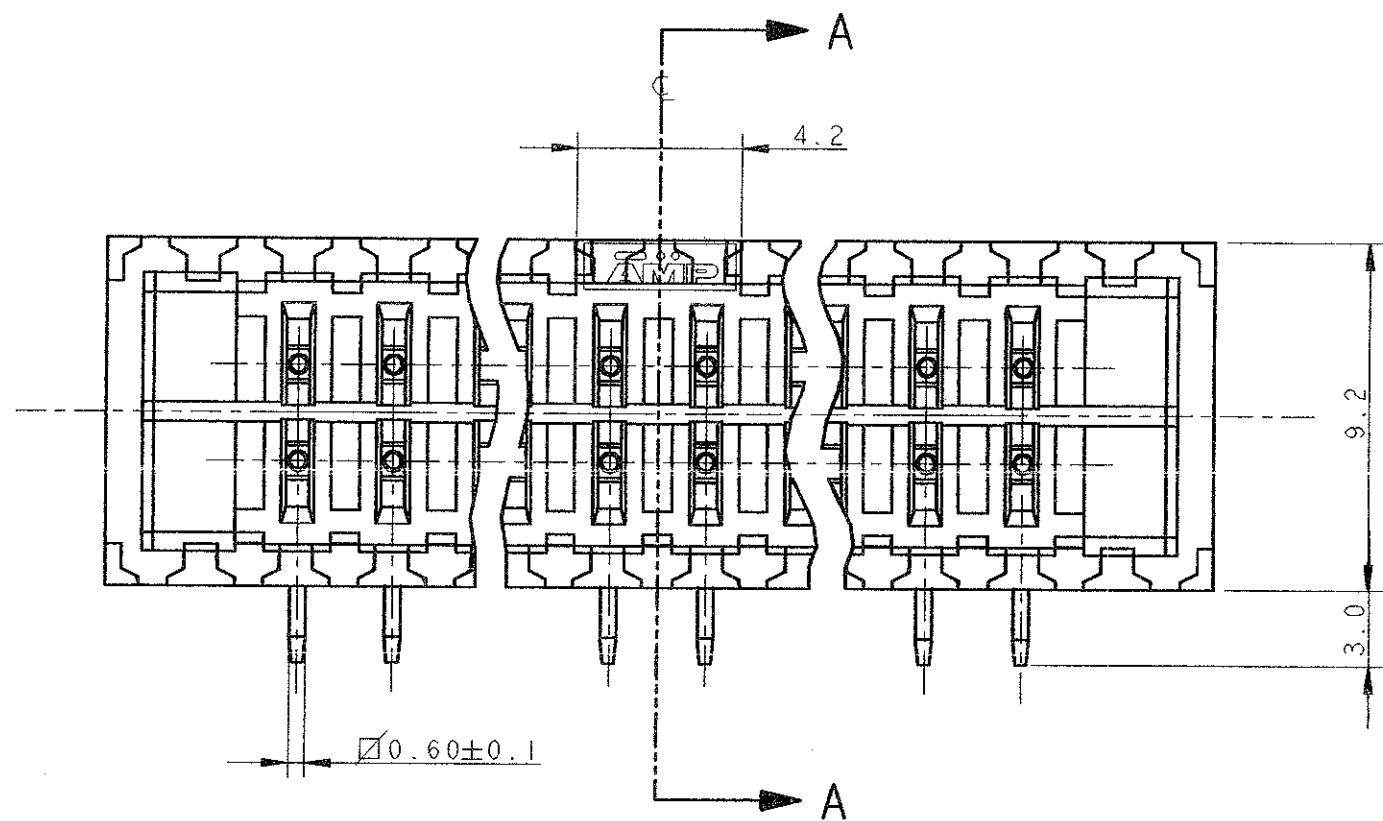

DIMENSIONS: mm 		TOLERANCES UNLESS OTHERWISE SPECIFIED: ±0.3 0 PLC ± 1 PLC ± 2 PLC ± 3 PLC ± 4 PLC ± ANGLES ±2°		DWN R. FABRIS 22JUL99 CHK C. TARTARI APVD PRODUCT SPEC 108-20038 APPLICATION SPEC WEIGHT		TE Connectivity NAME AMP-LATCH POST SUPPORT ASS'Y 90° LOW PROFILE	
MATERIAL 		FINISH 		SIZE A3 CAGE CODE 00779 DRAWING NO C-281279 RESTRICTED TO		SCALE 5:1 SHEET 1 OF 2 REV P2	
CUSTOMER DRAWING				CUSTOMER DRAWING			

POS.	N° VIE	PART NUMBER	REV.	DIM. 'A'	DIM. 'B'	DIM. 'C'
10	5x2	281279-5	N	10.16	17.78	20.32
14	7x2	281280-5	N	15.24	22.86	25.40
16	8x2	281281-5	N	17.78	25.40	27.94
20	10x2	281282-5	N	22.86	30.48	33.02
26	13x2	281283-5	N	30.48	38.10	40.64
34	17x2	281284-5	N	40.64	48.26	50.80
40	20x2	281285-5	N	48.26	55.88	58.42
50	25x2	281286-5	N	60.96	68.58	71.12
60	30x2	284361-5	N	73.66	81.28	83.82

△2 △6 △9

POS.	N° VIE	PART NUMBER	REV.	DIM. 'A'	DIM. 'B'	DIM. 'C'
10	5x2	281279-2	N	10.16	17.78	20.32
14	7x2	281280-2	N	15.24	22.86	25.40
16	8x2	281281-2	N	17.78	25.40	27.94
20	10x2	281282-2	N	22.86	30.48	33.02
26	13x2	281283-2	N	30.48	38.10	40.64
34	17x2	281284-2	N	40.64	48.26	50.80
40	20x2	281285-2	N	48.26	55.88	58.42
50	25x2	281286-2	N	60.96	68.58	71.12
-	-	-	-	-	-	-

△1 △5 △9

POS.	N° VIE	PART NUMBER	REV.	DIM. 'A'	DIM. 'B'	DIM. 'C'
10	5x2	281279-1	N	10.16	17.78	20.32
14	7x2	281280-1	N	15.24	22.86	25.40
16	8x2	281281-1	N	17.78	25.40	27.94
20	10x2	281282-1	N	22.86	30.48	33.02
26	13x2	281283-1	N	30.48	38.10	40.64
34	17x2	281284-1	N	40.64	48.26	50.80
40	20x2	281285-1	N	48.26	55.88	58.42
50	25x2	281286-1	N	60.96	68.58	71.12
-	-	-	-	-	-	-

△1 △4 △9

POS.	N° VIE	PART NUMBER	REV.	DIM. 'A'	DIM. 'B'	DIM. 'C'
10	5x2	281279-3	P	10.16	17.78	20.32
14	7x2	281280-3	P	15.24	22.86	25.40
16	8x2	281281-3	P	17.78	25.40	27.94
20	10x2	281282-3	P	22.86	30.48	33.02
26	13x2	281283-3	P	30.48	38.10	40.64
34	17x2	281284-3	P	40.64	48.26	50.80
40	20x2	281285-3	P	48.26	55.88	58.42
50	25x2	281286-3	P	60.96	68.58	71.12
60	30x2	284361-3	P	73.66	81.28	83.82

△1 △6 △9

P	LTR	DESCRIPTION	DATE	DWN	APVD
-	-	SEE SHEET 1 OF 2	-	-	-

△1 MATERIALE BLOCCHETTO: P.B.T. CARICATO VETRO, COLORE NERO
(HOUSING MATERIAL: P.B.T. G.F. FILLED, BLACK COLOUR)

△2 MATERIALE BLOCCHETTO: P.B.T. CARICATO VETRO, COLORE GRIGIO
(HOUSING MATERIAL: P.B.T. G.F. FILLED, GRAY COLOUR)

△3 MATERIALE CONTATTO: OTTONE
(CONTACT MATERIAL: BRASS)





△4 FINITURA CONTATTO: 0.76µm DI ORO SU NICKEL NELLA ZONA DI CONTATTO
STAGNO SU NICKEL NELLA ZONA A SALDARE
(CONTACT FINISH: 0.76µm OF GOLD OVER NICKEL ON CONTACT ZONE
TIN OVER NICKEL ON SOLDER TAIL)

△5 FINITURA CONTATTO: 0.38µm DI ORO SU NICKEL NELLA ZONA DI CONTATTO
STAGNO SU NICKEL NELLA ZONA A SALDARE
(CONTACT FINISH: 0.38µm OF GOLD OVER NICKEL ON CONTACT ZONE
TIN OVER NICKEL ON SOLDER TAIL)

△6 FINITURA CONTATTO: 0.20µm DI ORO SU NICKEL NELLA ZONA DI CONTATTO
STAGNO SU NICKEL NELLA ZONA A SALDARE
(CONTACT FINISH: 0.20µm OF GOLD OVER NICKEL ON CONTACT ZONE
TIN OVER NICKEL ON SOLDER TAIL)

△7 NON IN PRODUZIONE
(NOT YET RELEASED IN PRODUCTION)

△8 TOLLERANZA NON CUMULATIVA
(NOT CUMULATIVE TOLERANCE)

△9 QUESTO CONNETTORE E' APPROVATO  E CERTIFICATO 
(THIS CONNECTOR IS  APPROVED AND  CERTIFIED)

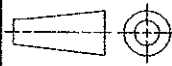
DWN R. FABRIS 22JUL99		CHK -		APVD 		NAME	
DIMENSIONS: mm		TOLERANCES UNLESS OTHERWISE SPECIFIED:		PRODUCT SPEC		AMP-LATCH POST SUPPORT ASS'Y 90° LOW PROFILE	
		0 PLC ±		APPLICATION SPEC		SIZE CAGE CODE DRAWING NO RESTRICTED TO	
MATERIAL		FINISH		WEIGHT		A3 00779 C=281279	
CUSTOMER DRAWING				SCALE 5:1		SHEET 2 OF 2 REV P2	

SEE SHEET 1

