



SMD - Metal Film resistors MELF Style

Specifications

Type		ZC0204	ZC0207
Style		0204	0207
Nominal Power rating P_{70}	W	0,25 (0,4W for min. 8.000hrs)	1,0
Resistance range	Ω	see next page	
E-series		see next page	
Tolerance	%	see next page	
Temperature coefficient	$10^{-6} \cdot K^{-1}$	see next page	
Max. cont. working voltage	V_{RMS}	200	500
Voltage coefficient	$10^{-6} \cdot V^{-1}$	< 1	
Insulation voltage (1min.)	V_{RMS}	300	500
Insulation resistance	Ω	> 10^4 M	> 10^4 M
Derating	$^{\circ}C$	linear 70 ... 155 (0W)	linear 70 ... 155 (0W)
Climatic category		55/155/56	55/155/56
Temperature range	$^{\circ}C$	-55...155	-55...155
Pad size / cut-layer	mm	1,5 x 1,5 / 35 μ	5,5 x 5,5 / 70 μ
Thermal resistance	KW^{-1}	200	85
Failure Rate (Total ϑ_0 max, 60% conf. lev.)	$10^{-9} h^{-1}$	< 10	< 5
Endurance (P_{70} , @ 70 $^{\circ}C$, 1000h intem.)	$[\Delta R/R]$ %	$\pm 0,25$	$\pm 1,5$
Damp heat, steady state (40 $^{\circ}C$, 93% r.h., 56d)	$[\Delta R/R]$ %	$\pm 0,25$	$\pm 0,5$
Climatic sequence	$[\Delta R/R]$ %	$\pm 0,1$	
Terminal Strength		Board-bend test, CECC 00802; 10 x 2 mm	
Resistance to soldering heat (260 $^{\circ}C$, 10s)	$[\Delta R/R]$ %	$\pm 0,1$	$\pm 0,25$
Solderability	S	Solder-bath test, CECC 00802, 95% wetting	
Current noise (DIN/IEC 195)	dB	R<10K : -25 R>10K : -25 + 8 / decade	
Nonlinearity (DIN/IEC 440)	dB	110	
OR0 (Jumper) Current rating		2A ($R_{max} = R015$)	
Marking		(DIN-IEC-Colour code, 5 bands)	

Dimensions in mm:

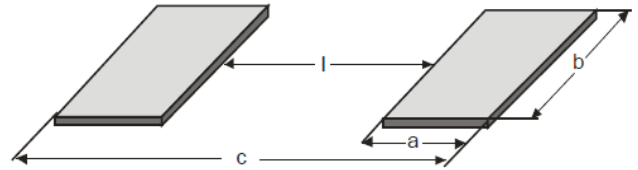
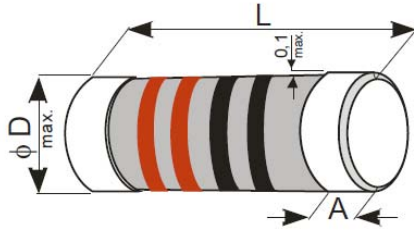

Type	L	A	Ø D max.
ZC0204	3,6 -0,2	0,5 +0,35	1,4
ZC0207	5,8 -0,3	0,9 ±0,30	2,2

TYPE	SOLDER PAD DIMENSIONS (mm)							
	WAVE SOLDERING				REFLOW SOLDERING			
	a	b	l	c	a	b	l	c
ZC0204	1,5	1,8	1,5	4,5	1,25	1,7	1,6	4,1
ZC0207	2,3	2,6	2,4	7,0	2,0	2,4	2,6	6,6

Resistance range ZG0207	Resistance range ZG0204	Tolerance	Temperature coefficient	E-Series
0R16 ... 0R2	0R22... 0R91	± 5%	100 * 10 ⁻⁶ K ⁻¹	E 24
0R22... 0R91	0R51... 0R91	± 2%	100 * 10 ⁻⁶ K ⁻¹	E 24
1R ... 10M	1R ... 10M	± 1%	50 * 10 ⁻⁶ K ⁻¹	E 24 / E 96
1R ... 2M2	10R ... 475K	± 0,5%	50 * 10 ⁻⁶ K ⁻¹	E 24 / E 96
-	10R ... 475K	± 0,5%	25 * 10 ⁻⁶ K ⁻¹	E 24 / E 96
-	10R ... 221K	± 0,5%	15 * 10 ⁻⁶ K ⁻¹	E 24 / E 96
100R ... 511K	22R ... 330K	± 0,25%	25 * 10 ⁻⁶ K ⁻¹	E 24 / E 96
-	22R ... 221K	± 0,25%	15 * 10 ⁻⁶ K ⁻¹	E 24 / E 96
100R ... 511K	43R ... 330K	± 0,1%	25 * 10 ⁻⁶ K ⁻¹	E 24 / E 96
-	43R ... 221K	± 0,1%	15 * 10 ⁻⁶ K ⁻¹	E 24 / E 96

Tolerance	Coding	Temperature coefficient	Coding	Coating
5%	J	100	F	Light green
2%	G	50	E	Light green
1%	F	25	D	pink
0,5%	D	15	C	violet
0,25%	C			
0,1%	B			

Ordering example:

0-0hm = ZC0204 F K E 07 1K
 Type Tolerance Blister Tape TC Reel Diameter R-Value

Packaging:

Type	Packaging	Pieces	Tolerance
ZC0204	8mm Blistertape - 7 inch	3000	all
	8mm Blistertape - 13 inch	10000	all
ZC0207	12mm Blistertape - 7 inch	1500	all

BLISTER TAPE

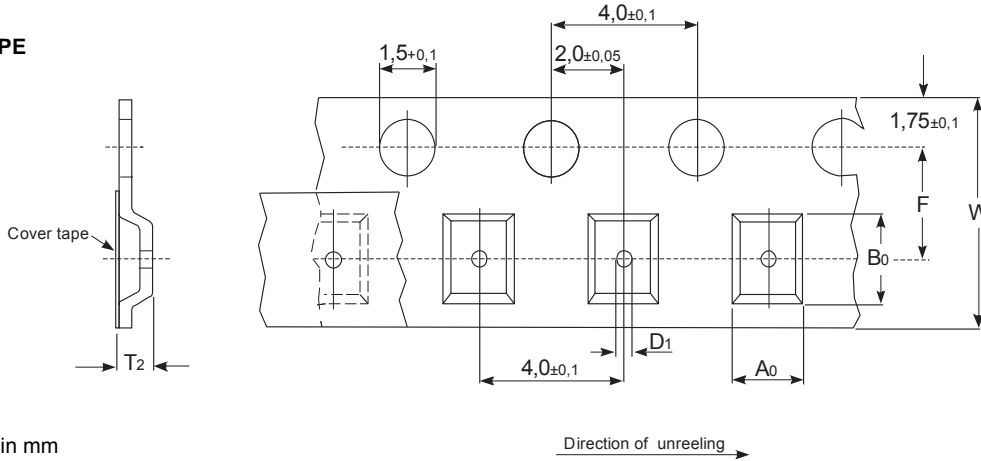

Dimensions in mm

Type	A ₀	B ₀	F	W	D ₁	T ₂
ZC0204	1,55 ±0,1	3,7 ±0,1	3,5 ±0,05	8,0 +0,3 / -0,1	1,0	≤1,8
ZC0207	2,40 ±0,1	6,0 ±0,1	5,5 ±0,05	12,0 ±0,3	1,5	≤2,7

LEADER AND TRAILER TAPE

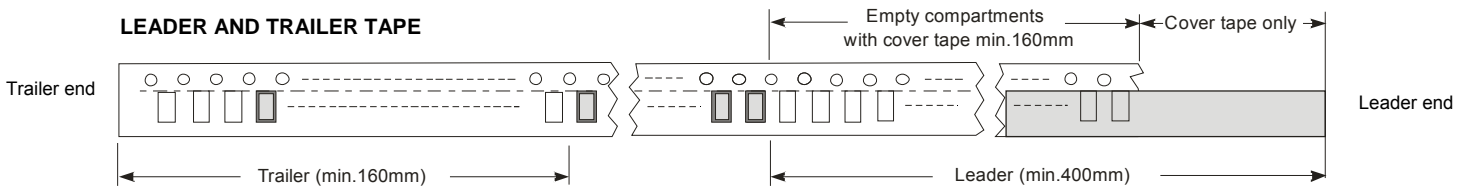

The minimum length of the leader is 400mm , which includes a minimum 160mm of carrier tape with empty compartments and sealed by the cover tape. The minimum length of the trailer is 160mm carrier tape with empty compartments and sealed by the cover tape.

REEL

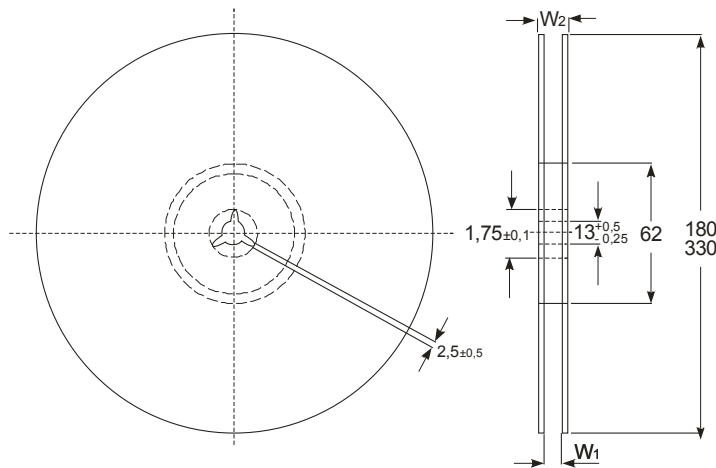

Type	W ₁	W ₂
ZC0204	8,4 +1,5 / -0,0	14,4 max.
ZC0207	12,4 +1,5 / -0,0	18,4 max.

SMD – Metal Film Resistors
MELF Style ZC0204

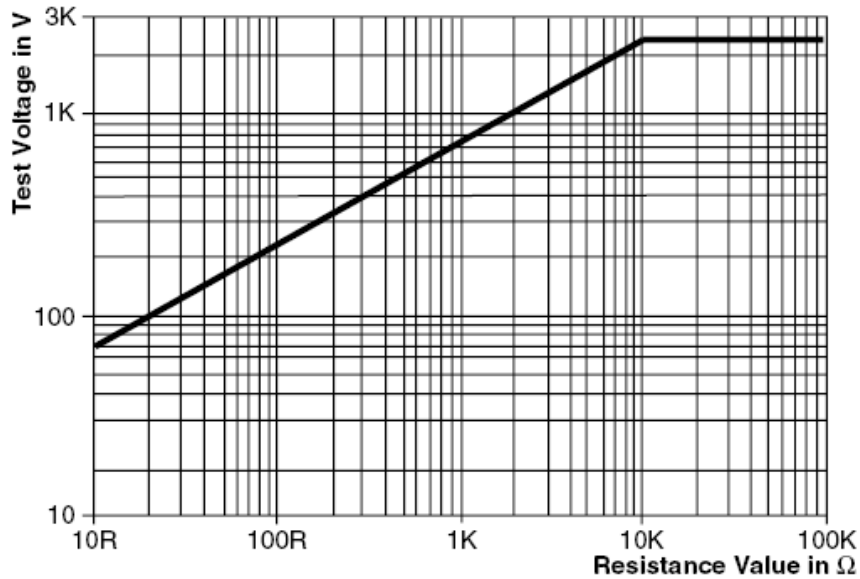

Single pulse high voltage overload test
1.2/50 acc. EN 60115-1, 4.27

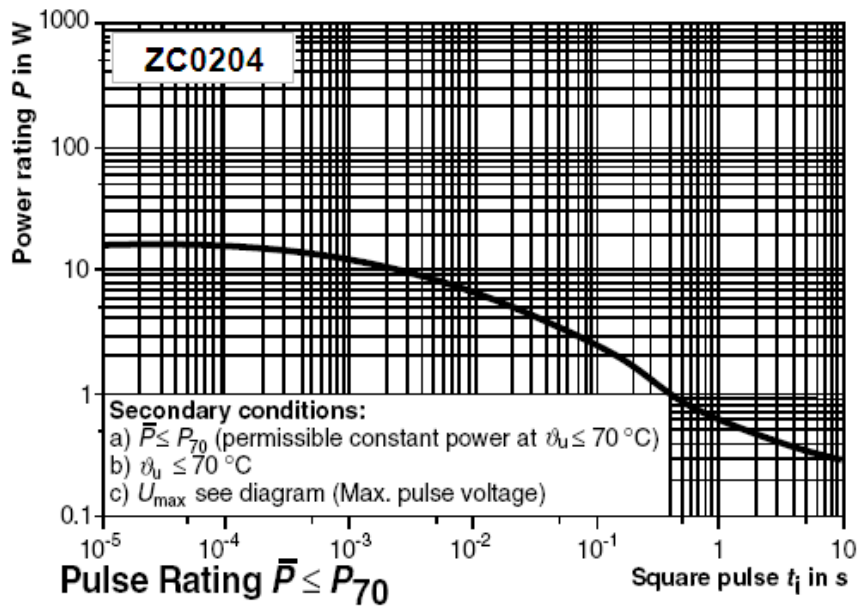

SMD – Metal Film Resistors
MELF Style ZC0204

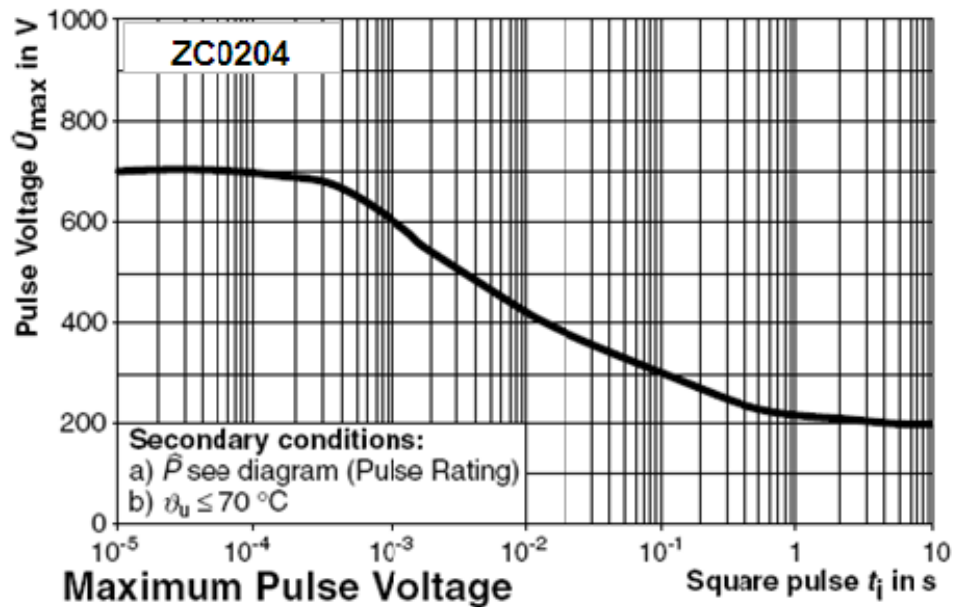
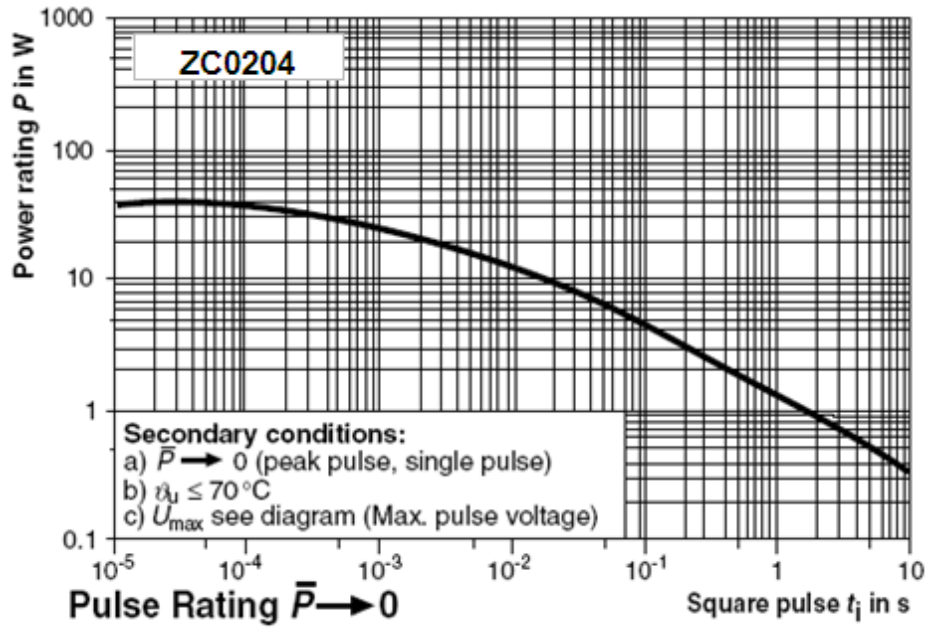

SMD – Metal Film Resistors
 MELF Style ZC0207

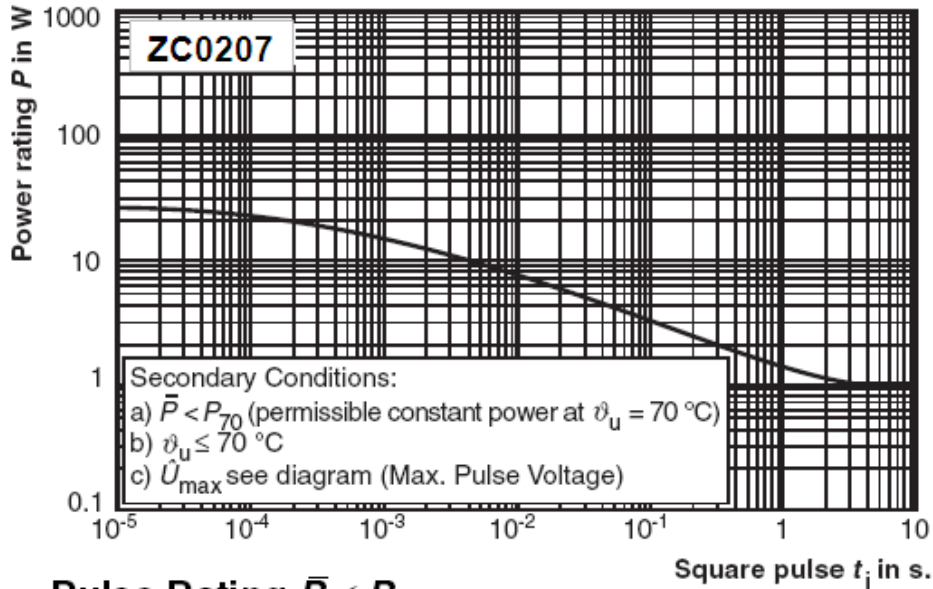

Pulse Rating $\bar{P} \leq P$

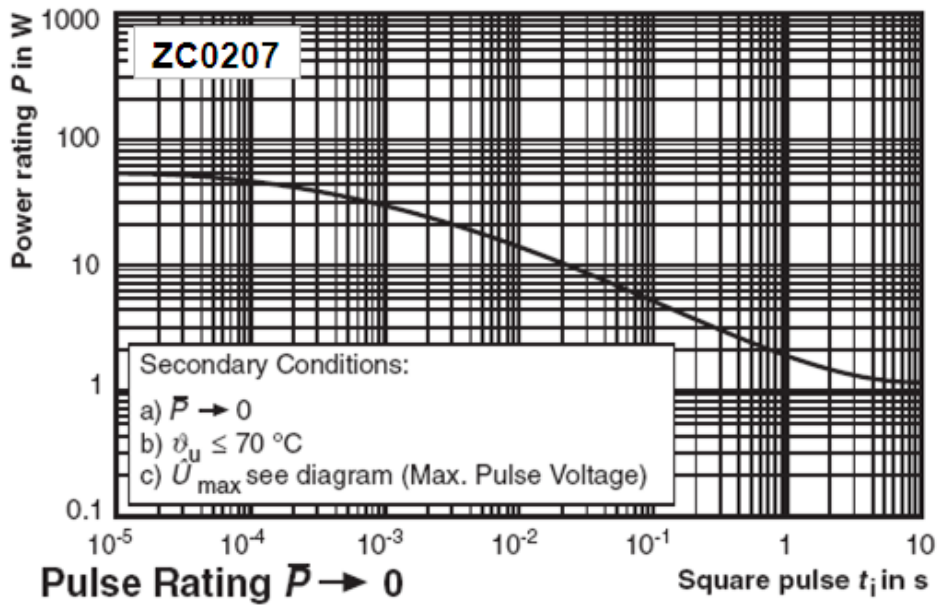

Pulse Rating $\bar{P} \rightarrow 0$

SMD – Metal Film Resistors
MELF Style ZC0207

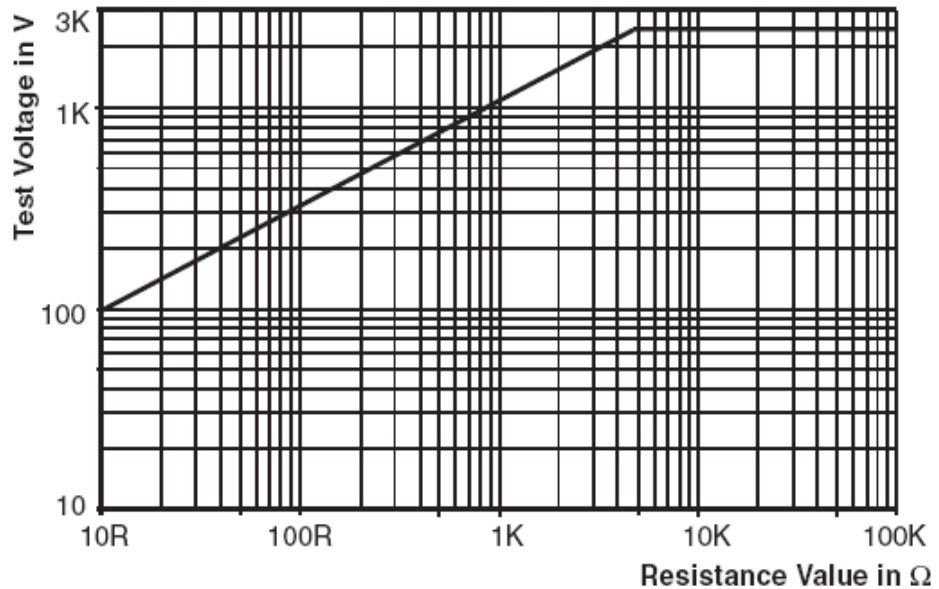
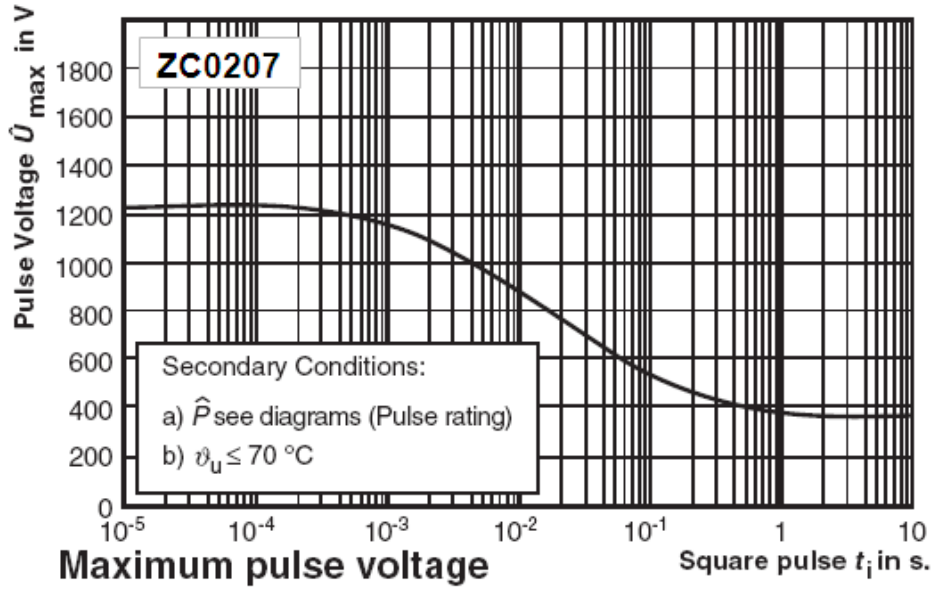

Single pulse high voltage overload test
1.2/50 acc. EN 60115-1, 4.27