

Notice for TAIYO YUDEN products

Please read this notice before using the TAIYO YUDEN products.

REMINDERS

- Product information in this catalog is as of October 2015. All of the contents specified herein are subject to change without notice due to technical improvements, etc. Therefore, please check for the latest information carefully before practical application or usage of the Products.

Please note that TAIYO YUDEN CO., LTD. shall not be responsible for any defects in products or equipment incorporating such products, which are caused under the conditions other than those specified in this catalog or individual specification.

- Please contact TAIYO YUDEN CO., LTD. for further details of product specifications as the individual specification is available.

- Please conduct validation and verification of products in actual condition of mounting and operating environment before commercial shipment of the equipment.

- All electronic components or functional modules listed in this catalog are developed, designed and intended for use in general electronics equipment.(for AV, office automation, household, office supply, information service, telecommunications, (such as mobile phone or PC) etc.). Before incorporating the components or devices into any equipment in the field such as transportation,(automotive control, train control, ship control), transportation signal, disaster prevention, medical, public information network (telephone exchange, base station) etc. which may have direct influence to harm or injure a human body, please contact TAIYO YUDEN CO., LTD. for more detail in advance.

Do not incorporate the products into any equipment in fields such as aerospace, aviation, nuclear control, submarine system, military, etc. where higher safety and reliability are especially required.

In addition, even electronic components or functional modules that are used for the general electronic equipment, if the equipment or the electric circuit require high safety or reliability function or performances, a sufficient reliability evaluation check for safety shall be performed before commercial shipment and moreover, due consideration to install a protective circuit is strongly recommended at customer's design stage.

- The contents of this catalog are applicable to the products which are purchased from our sales offices or distributors (so called "TAIYO YUDEN' s official sales channel").

It is only applicable to the products purchased from any of TAIYO YUDEN' s official sales channel.

- Please note that TAIYO YUDEN CO., LTD. shall have no responsibility for any controversies or disputes that may occur in connection with a third party's intellectual property rights and other related rights arising from your usage of products in this catalog. TAIYO YUDEN CO., LTD. grants no license for such rights.

- Caution for export

Certain items in this catalog may require specific procedures for export according to "Foreign Exchange and Foreign Trade Control Law" of Japan, "U.S. Export Administration Regulations", and other applicable regulations. Should you have any question or inquiry on this matter, please contact our sales staff.

MULTILAYER CHIP BEAD INDUCTORS(BK SERIES)



WAVE* REFLOW

*Except for BK0402, BK0603, BK1005

PARTS NUMBER

* Operating Temp.: -55~+125°C

B	K	△	1	6	0	8	H	S	1	2	1	-	T	△
①	②	③	④	⑤	⑥	⑦								

△ = Blank space

① Series name

Code	Series name
BK△	Multilayer chip bead inductor

② Dimensions (L × W)

Code	Type (inch)	Dimensions (L × W) [mm]
0402	0402 (01005)	0.4 × 0.2
0603	0603 (0201)	0.6 × 0.3
1005	1005 (0402)	1.0 × 0.5
1608	1608 (0603)	1.6 × 0.8
2125	2125 (0805)	2.0 × 1.25

③ Material

Code	Material
HW	Refer to impedance curves for material differences
HS	
HR	
HM	
LM	
LL	
TS	
TM	

④ Nominal impedance

Code (example)	Nominal impedance [Ω]
150	15
101	100
102	1000

⑤ Characteristics

Code	Characteristics
-	Standard

⑥ Packaging

Code	Packaging
T	Taping

⑦ Internal code

Code	Internal code
△	Standard

STANDARD EXTERNAL DIMENSIONS / STANDARD QUANTITY

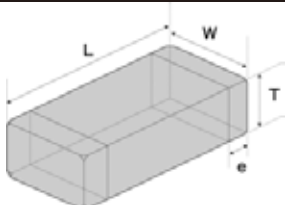

Type	L	W	T	e	Standard quantity [pcs]	
					Paper tape	Embossed tape
BK 0402 (01005)	0.40 ± 0.02 (0.016 ± 0.001)	0.20 ± 0.02 (0.008 ± 0.001)	0.20 ± 0.02 (0.008 ± 0.001)	0.10 + 0.04 / - 0.03 (0.004 + 0.002 / - 0.001)	20000	-
BK 0603 (0201)	0.60 ± 0.03 (0.024 ± 0.001)	0.30 ± 0.03 (0.012 ± 0.001)	0.30 ± 0.03 (0.012 ± 0.001)	0.15 ± 0.05 (0.006 ± 0.002)	15000	-
BK 1005 (0402)	1.00 ± 0.05 (0.039 ± 0.002)	0.50 ± 0.05 (0.020 ± 0.002)	0.50 ± 0.05 (0.020 ± 0.002)	0.25 ± 0.10 (0.010 ± 0.004)	10000	-
BK 1608 (0603)	1.6 ± 0.15 (0.063 ± 0.006)	0.8 ± 0.15 (0.031 ± 0.006)	0.8 ± 0.15 (0.031 ± 0.006)	0.3 ± 0.2 (0.012 ± 0.008)	4000	-
BK 2125 (0805)	2.0 + 0.3 / - 0.1 (0.079 + 0.012 / - 0.004)	1.25 ± 0.2 (0.049 ± 0.008)	0.85 ± 0.2 (0.033 ± 0.008)	0.5 ± 0.3 (0.020 ± 0.012)	4000	-
	2.0 + 0.3 / - 0.1 (0.079 + 0.012 / - 0.004)	1.25 ± 0.2 (0.049 ± 0.008)	1.25 ± 0.2 (0.049 ± 0.008)	0.5 ± 0.3 (0.020 ± 0.012)	-	2000

Unit: mm (inch)

► This catalog contains the typical specification only due to the limitation of space. When you consider the purchase of our products, please check our specification. For details of each product (characteristics graph, reliability information, precautions for use, and so on), see our Web site (<http://www.ty-top.com/>).

■ PARTS NUMBER

● BK 0402

Parts number	EHS	Nominal impedance [Ω]	Impedance tolerance	Measuring frequency [MHz]	DC Resistance [Ω] (max.)	Rated current [mA] (max.)	Thickness [mm]
BK 0402HS100-T	RoHS	10	±5Ω	100	0.10	540	0.20 ±0.02
BK 0402HS700-T	RoHS	70	±25%	100	0.37	280	0.20 ±0.02
BK 0402HS121-T	RoHS	120	±25%	100	0.53	240	0.20 ±0.02
BK 0402HM100-T	RoHS	10	±5Ω	100	0.07	750	0.20 ±0.02
BK 0402HM750-T	RoHS	75	±25%	100	0.45	260	0.20 ±0.02
BK 0402HM121-T	RoHS	120	±25%	100	0.60	220	0.20 ±0.02
BK 0402HM151-T	RoHS	150	±25%	100	0.65	200	0.20 ±0.02
BK 0402HM181-T	RoHS	180	±25%	100	0.75	200	0.20 ±0.02
BK 0402HM241-T	RoHS	240	±25%	100	0.90	200	0.20 ±0.02
BK 0402HM331-T	RoHS	330	±25%	100	1.20	150	0.20 ±0.02
BK 0402LL220-T	RoHS	22	±25%	100	0.70	150	0.20 ±0.02

● BK 0603

Parts number	EHS	Nominal impedance [Ω]	Impedance tolerance	Measuring frequency [MHz]	DC Resistance [Ω] (max.)	Rated current [mA] (max.)	Thickness [mm]
BK 0603HS220-T	RoHS	22	±25%	100	0.065	500	0.30 ±0.03
BK 0603HS330-T	RoHS	33	±25%	100	0.070	500	0.30 ±0.03
BK 0603HS800-T	RoHS	80	±25%	100	0.40	200	0.30 ±0.03
BK 0603HS121-T	RoHS	120	±25%	100	0.45	200	0.30 ±0.03
BK 0603HS241-T	RoHS	240	±25%	100	0.65	200	0.30 ±0.03
BK 0603HS601-T	RoHS	600	±25%	100	1.20	150	0.30 ±0.03
BK 0603HM600-T	RoHS	60	±25%	100	0.25	200	0.30 ±0.03
BK 0603HM121-T	RoHS	120	±25%	100	0.40	200	0.30 ±0.03
BK 0603HM241-T	RoHS	240	±25%	100	0.80	200	0.30 ±0.03
BK 0603HM471-T	RoHS	470	±25%	100	1.05	100	0.30 ±0.03
BK 0603HM601-T	RoHS	600	±25%	100	1.20	100	0.30 ±0.03
BK 0603HR121-T	RoHS	120	±25%	100	0.23	450	0.30 ±0.03
BK 0603HR241-T	RoHS	240	±25%	100	0.38	350	0.30 ±0.03
BK 0603HR601-T	RoHS	600	±25%	100	0.80	250	0.30 ±0.03
BK 0603HR102-T	RoHS	1000	±25%	100	1.15	220	0.30 ±0.03
BK 0603HR122-T	RoHS	1200	±25%	100	1.30	200	0.30 ±0.03
BK 0603LL100-T	RoHS	10	±25%	100	0.25	200	0.30 ±0.03
BK 0603LL220-T	RoHS	22	±25%	100	0.45	200	0.30 ±0.03
BK 0603LL330-T	RoHS	33	±25%	100	0.55	150	0.30 ±0.03
BK 0603LL470-T	RoHS	47	±25%	100	0.70	150	0.30 ±0.03
BK 0603LL560-T	RoHS	56	±25%	100	1.00	100	0.30 ±0.03
BK 0603LL800-T	RoHS	80	±25%	100	1.30	100	0.30 ±0.03
BK 0603LL121-T	RoHS	120	±25%	100	1.50	100	0.30 ±0.03
BK 0603TS800-T	RoHS	80	±25%	100	0.18	500	0.30 ±0.03
BK 0603TS121-T	RoHS	120	±25%	100	0.23	450	0.30 ±0.03
BK 0603TS241-T	RoHS	240	±25%	100	0.32	400	0.30 ±0.03
BK 0603TS601-T	RoHS	600	±25%	100	0.75	270	0.30 ±0.03
BK 0603TM800-T	RoHS	80	±25%	100	0.18	450	0.30 ±0.03
BK 0603TM121-T	RoHS	120	±25%	100	0.23	400	0.30 ±0.03
BK 0603TM241-T	RoHS	240	±25%	100	0.38	300	0.30 ±0.03
BK 0603TM601-T	RoHS	600	±25%	100	0.85	250	0.30 ±0.03

● BK 1005

Parts number	EHS	Nominal impedance [Ω]	Impedance tolerance	Measuring frequency [MHz]	DC Resistance [Ω] (max.)	Rated current [mA] (max.)	Thickness [mm]
BK 1005HW680-T	RoHS	68	±25%	100	0.17	500	0.50 ±0.05
BK 1005HW121-T	RoHS	120	±25%	100	0.24	450	0.50 ±0.05
BK 1005HW241-T	RoHS	240	±25%	100	0.31	400	0.50 ±0.05
BK 1005HW431-T	RoHS	430	±25%	100	0.50	350	0.50 ±0.05
BK 1005HW601-T	RoHS	600	±25%	100	0.60	300	0.50 ±0.05
BK 1005HS100-T	RoHS	10	±25%	100	0.03	1,000	0.50 ±0.05
BK 1005HS330-T	RoHS	33	±25%	100	0.06	700	0.50 ±0.05
BK 1005HS680-T	RoHS	68	±25%	100	0.10	700	0.50 ±0.05
BK 1005HS800-T	RoHS	80	±25%	100	0.10	700	0.50 ±0.05
BK 1005HS121-T	RoHS	120	±25%	100	0.20	500	0.50 ±0.05
BK 1005HS241-T	RoHS	240	±25%	100	0.30	400	0.50 ±0.05
BK 1005HS431-T	RoHS	430	±25%	100	0.45	350	0.50 ±0.05
BK 1005HS601-T	RoHS	600	±25%	100	0.55	300	0.50 ±0.05
BK 1005HS102-T	RoHS	1000	±25%	100	0.58	300	0.50 ±0.05
BK 1005HR601-T	RoHS	600	±25%	100	0.60	300	0.50 ±0.05
BK 1005HM750-T	RoHS	75	±25%	100	0.18	350	0.50 ±0.05
BK 1005HM121-T	RoHS	120	±25%	100	0.18	300	0.50 ±0.05
BK 1005HM241-T	RoHS	240	±25%	100	0.30	300	0.50 ±0.05
BK 1005HM471-T	RoHS	470	±25%	100	0.45	250	0.50 ±0.05
BK 1005HM601-T	RoHS	600	±25%	100	0.50	250	0.50 ±0.05
BK 1005HM102-T	RoHS	1000	±25%	100	0.70	150	0.50 ±0.05
BK 1005LL100-T	RoHS	10	±25%	100	0.11	500	0.50 ±0.05
BK 1005LL220-T	RoHS	22	±25%	100	0.18	400	0.50 ±0.05
BK 1005LL330-T	RoHS	33	±25%	100	0.25	400	0.50 ±0.05
BK 1005LL470-T	RoHS	47	±25%	100	0.33	350	0.50 ±0.05
BK 1005LL680-T	RoHS	68	±25%	100	0.31	400	0.50 ±0.05
BK 1005LL121-T	RoHS	120	±25%	100	0.45	350	0.50 ±0.05
BK 1005LL181-T	RoHS	180	±25%	100	0.50	300	0.50 ±0.05
BK 1005LL241-T	RoHS	240	±25%	100	0.70	250	0.50 ±0.05
BK 1005LM182-T	RoHS	1800	±25%	100	0.90	120	0.50 ±0.05

▶ This catalog contains the typical specification only due to the limitation of space. When you consider the purchase of our products, please check our specification. For details of each product (characteristics graph, reliability information, precautions for use, and so on), see our Web site (<http://www.ty-top.com/>).

BK 1608

Parts number	EHS	Nominal impedance [Ω]	Impedance tolerance	Measuring frequency [MHz]	DC Resistance [Ω] (max.)	Rated current [mA] (max.)	Thickness [mm]
BK 1608HW121-T	RoHS	120	±25%	100	0.15	600	0.80 ±0.15
BK 1608HW241-T	RoHS	240	±25%	100	0.25	450	0.80 ±0.15
BK 1608HW431-T	RoHS	430	±25%	100	0.30	400	0.80 ±0.15
BK 1608HW601-T	RoHS	600	±25%	100	0.40	300	0.80 ±0.15
BK 1608HS220-T	RoHS	22	±25%	100	0.05	1,500	0.80 ±0.15
BK 1608HS330-T	RoHS	33	±25%	100	0.08	1,200	0.80 ±0.15
BK 1608HS470-T	RoHS	47	±25%	100	0.10	900	0.80 ±0.15
BK 1608HS600-T	RoHS	60	±25%	100	0.10	800	0.80 ±0.15
BK 1608HS800-T	RoHS	80	±25%	100	0.10	600	0.80 ±0.15
BK 1608HS121-T	RoHS	120	±25%	100	0.18	500	0.80 ±0.15
BK 1608HS241-T	RoHS	240	±25%	100	0.25	400	0.80 ±0.15
BK 1608HS601-T	RoHS	600	±25%	100	0.45	350	0.80 ±0.15
BK 1608HS102-T	RoHS	1000	±25%	100	0.60	300	0.80 ±0.15
BK 1608HM121-T	RoHS	120	±25%	100	0.20	350	0.80 ±0.15
BK 1608HM241-T	RoHS	240	±25%	100	0.35	300	0.80 ±0.15
BK 1608HM471-T	RoHS	470	±25%	100	0.45	250	0.80 ±0.15
BK 1608HM601-T	RoHS	600	±25%	100	0.60	250	0.80 ±0.15
BK 1608HM102-T	RoHS	1000	±25%	100	0.70	200	0.80 ±0.15
BK 1608LL300-T	RoHS	30	±25%	100	0.20	500	0.80 ±0.15
BK 1608LL470-T	RoHS	47	±25%	100	0.30	400	0.80 ±0.15
BK 1608LL560-T	RoHS	56	±25%	100	0.30	400	0.80 ±0.15
BK 1608LL680-T	RoHS	68	±25%	100	0.35	300	0.80 ±0.15
BK 1608LL121-T	RoHS	120	±25%	100	0.50	300	0.80 ±0.15
BK 1608LL181-T	RoHS	180	±25%	100	0.65	250	0.80 ±0.15
BK 1608LL241-T	RoHS	240	±25%	100	0.80	250	0.80 ±0.15
BK 1608LL331-T	RoHS	330	±25%	100	0.85	200	0.80 ±0.15
BK 1608LL431-T	RoHS	430	±25%	100	0.85	200	0.80 ±0.15
BK 1608LL511-T	RoHS	510	±25%	100	0.90	200	0.80 ±0.15
BK 1608LL681-T	RoHS	680	±25%	100	1.00	150	0.80 ±0.15
BK 1608LM751-T	RoHS	750	±25%	100	0.60	300	0.80 ±0.15
BK 1608LM152-T	RoHS	1500	±25%	100	0.75	250	0.80 ±0.15
BK 1608LM182-T	RoHS	1800	±25%	100	0.85	200	0.80 ±0.15
BK 1608LM252-T	RoHS	2500	±25%	100	1.10	200	0.80 ±0.15
BK 1608TS431-T	RoHS	430	±25%	100	0.21 ±30%	400	0.80 ±0.15
BK 1608TS601-T	RoHS	600	±25%	100	0.27 ±30%	350	0.80 ±0.15
BK 1608TS102-T	RoHS	1000	±25%	100	0.30 ±30%	300	0.80 ±0.15

BK 2125

Parts number	EHS	Nominal impedance [Ω]	Impedance tolerance	Measuring frequency [MHz]	DC Resistance [Ω] (max.)	Rated current [mA] (max.)	Thickness [mm]
BK 2125HS150-T	RoHS	15	±25%	100	0.05	1,200	0.85 ±0.2
BK 2125HS220-T	RoHS	22	±25%	100	0.05	1,200	0.85 ±0.2
BK 2125HS330-T	RoHS	33	±25%	100	0.05	1,200	0.85 ±0.2
BK 2125HS470-T	RoHS	47	±25%	100	0.05	1,000	0.85 ±0.2
BK 2125HS750-T	RoHS	75	±25%	100	0.10	1,000	0.85 ±0.2
BK 2125HS101-T	RoHS	100	±25%	100	0.10	900	0.85 ±0.2
BK 2125HS121-T	RoHS	120	±25%	100	0.15	800	0.85 ±0.2
BK 2125HS241-T	RoHS	240	±25%	100	0.20	600	0.85 ±0.2
BK 2125HS431-T	RoHS	430	±25%	100	0.25	500	0.85 ±0.2
BK 2125HS601-T	RoHS	600	±25%	100	0.30	500	0.85 ±0.2
BK 2125HS102-T	RoHS	1000	±25%	100	0.40	300	0.85 ±0.2
BK 2125HM121-T	RoHS	120	±25%	100	0.15	800	0.85 ±0.2
BK 2125HM241-T	RoHS	240	±25%	100	0.20	600	0.85 ±0.2
BK 2125HM471-T	RoHS	470	±25%	100	0.25	500	0.85 ±0.2
BK 2125HM601-T	RoHS	600	±25%	100	0.25	500	0.85 ±0.2
BK 2125HM102-T	RoHS	1000	±25%	100	0.35	400	0.85 ±0.2
BK 2125LL560-T	RoHS	56	±25%	100	0.20	600	0.85 ±0.2
BK 2125LL121-T	RoHS	120	±25%	100	0.30	400	0.85 ±0.2
BK 2125LL241-T	RoHS	240	±25%	100	0.35	300	0.85 ±0.2
BK 2125LM751-T	RoHS	750	±25%	100	0.30	400	0.85 ±0.2
BK 2125LM152-T	RoHS	1500	±25%	100	0.35	400	0.85 ±0.2
BK 2125LM182-T	RoHS	1800	±25%	100	0.45	300	1.25 ±0.2
BK 2125LM252-T	RoHS	2500	±25%	100	0.75	200	1.25 ±0.2

BK0402

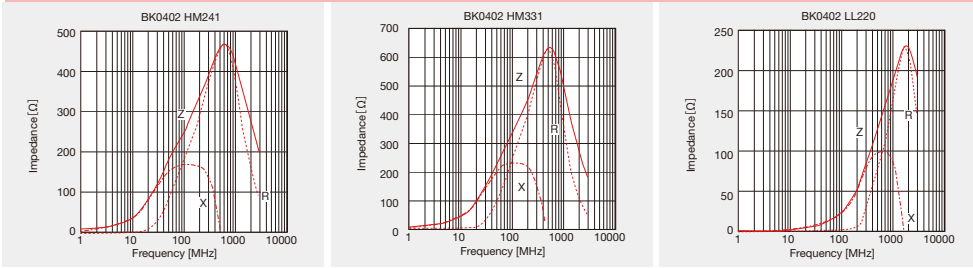
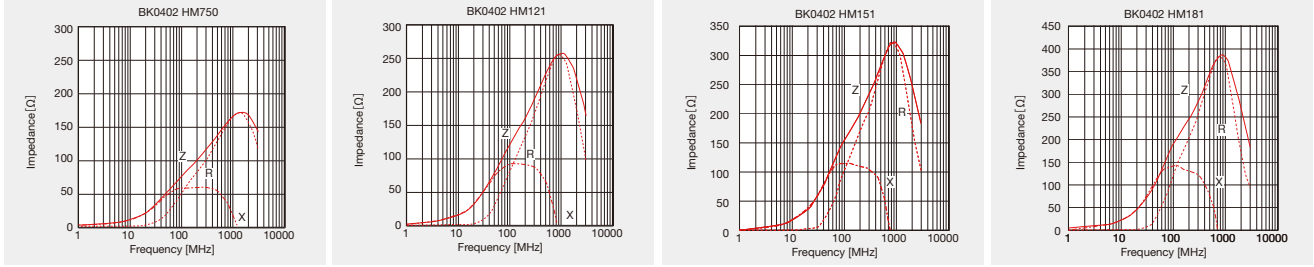
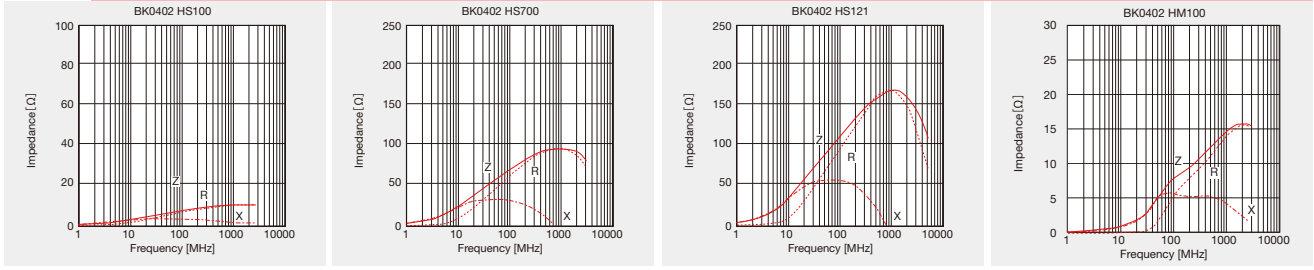

BK0603

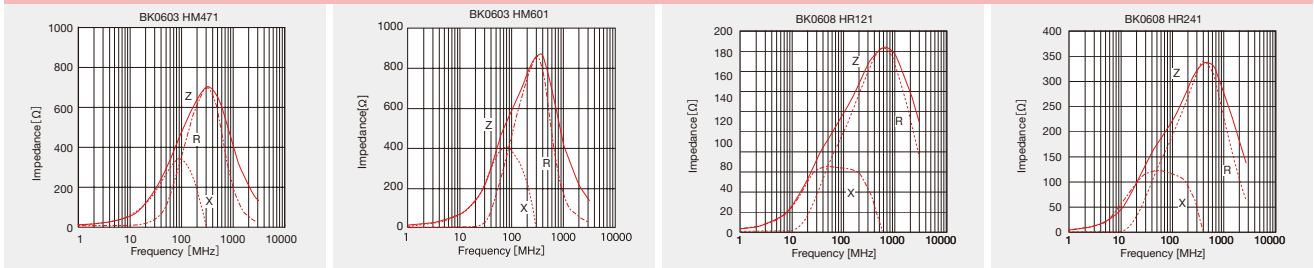
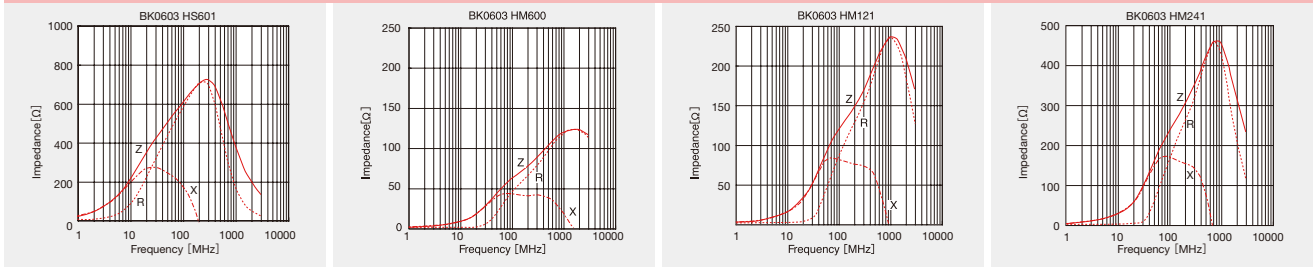
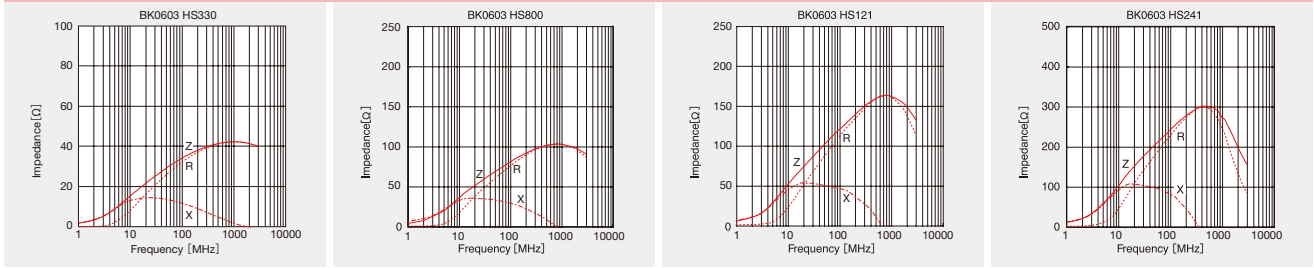
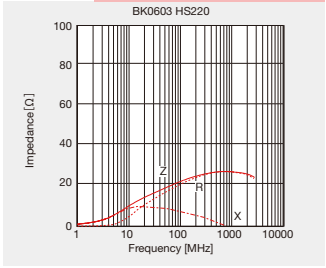

► This catalog contains the typical specification only due to the limitation of space. When you consider the purchase of our products, please check our specification. For details of each product (characteristics graph, reliability information, precautions for use, and so on), see our Web site (<http://www.ty-top.com/>).

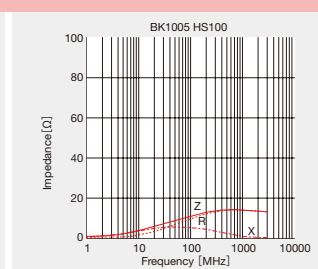
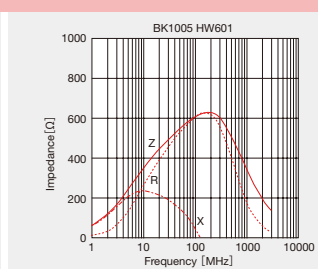
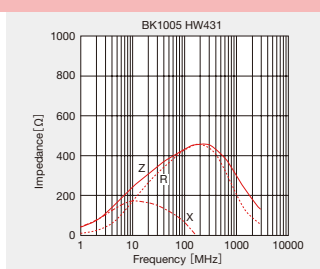
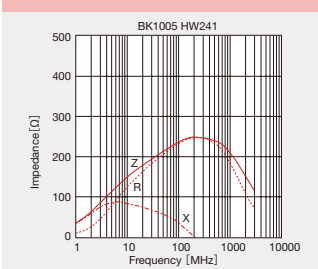
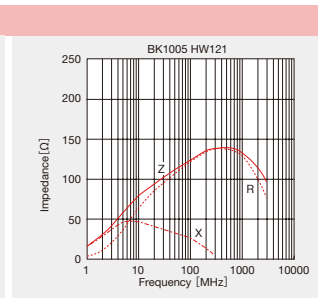
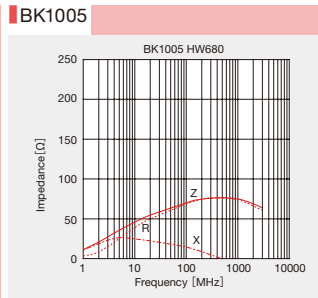
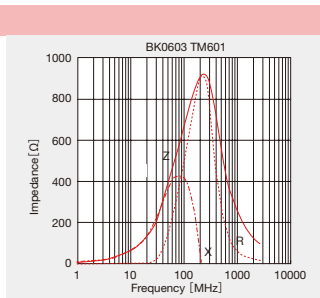
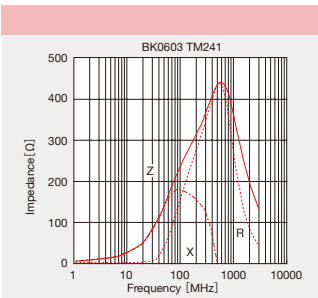
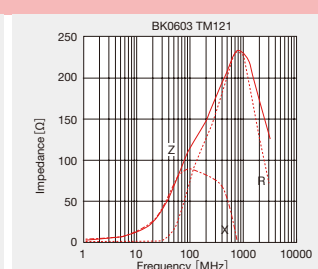
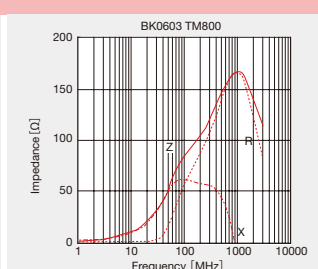
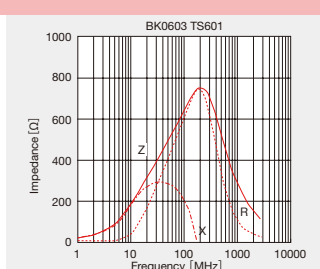
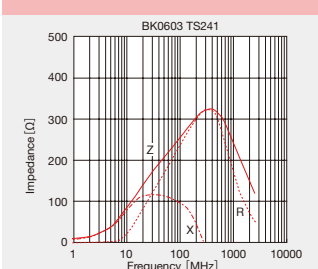
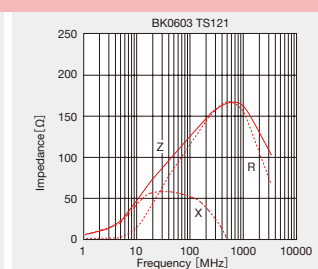
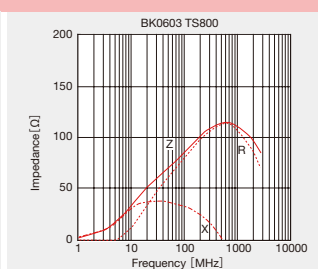
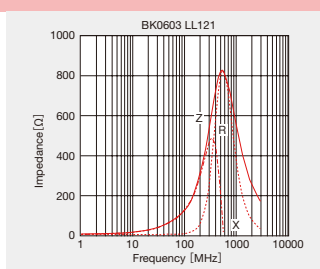
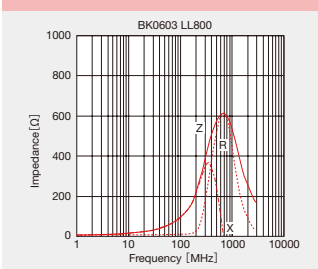
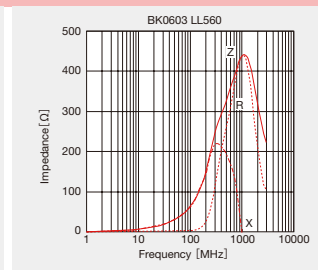
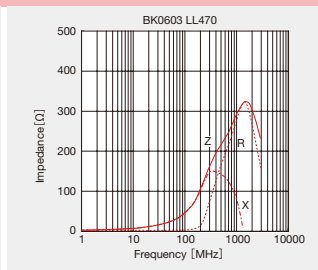
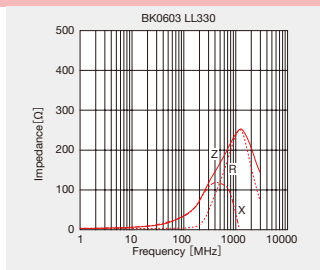
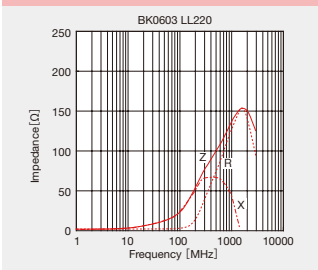
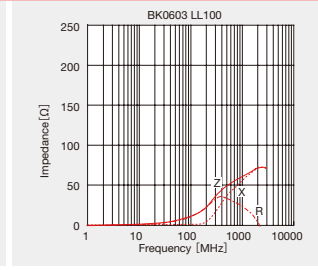
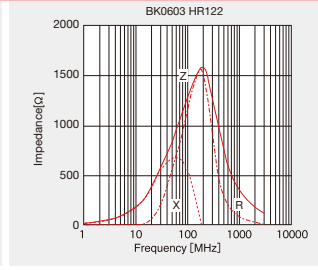
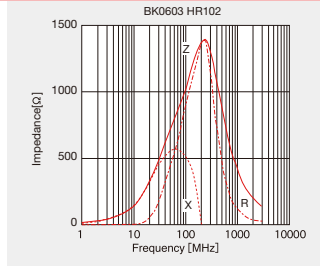
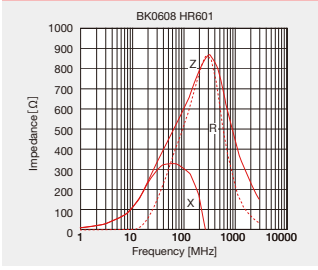

► This catalog contains the typical specification only due to the limitation of space. When you consider the purchase of our products, please check our specification. For details of each product (characteristics graph, reliability information, precautions for use, and so on), see our Web site (<http://www.ty-top.com/>).

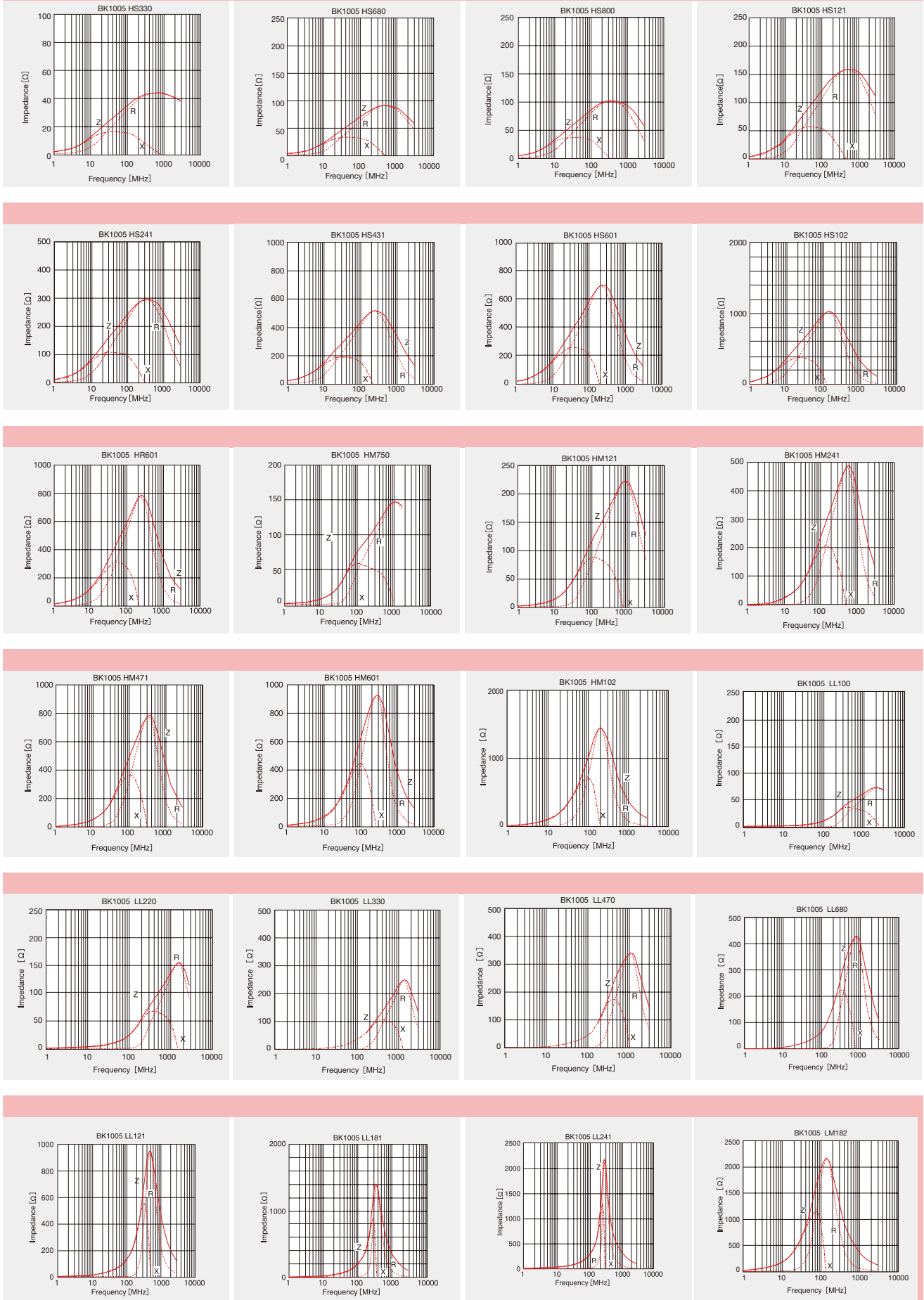

▶ This catalog contains the typical specification only due to the limitation of space. When you consider the purchase of our products, please check our specification. For details of each product (characteristics graph, reliability information, precautions for use, and so on), see our Web site (<http://www.ty-top.com/>).

BK1608

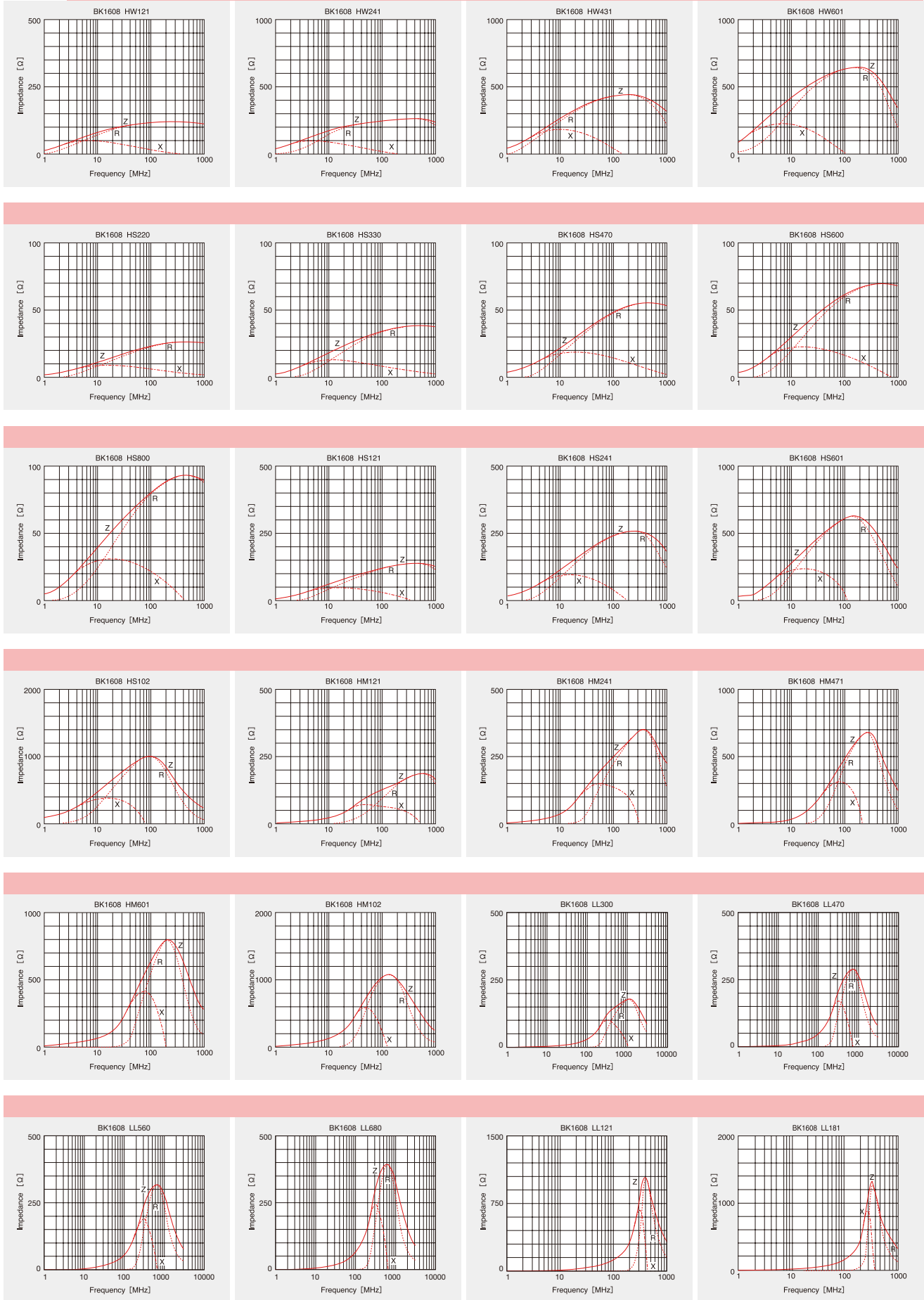

► This catalog contains the typical specification only due to the limitation of space. When you consider the purchase of our products, please check our specification. For details of each product (characteristics graph, reliability information, precautions for use, and so on), see our Web site (<http://www.ty-top.com/>).

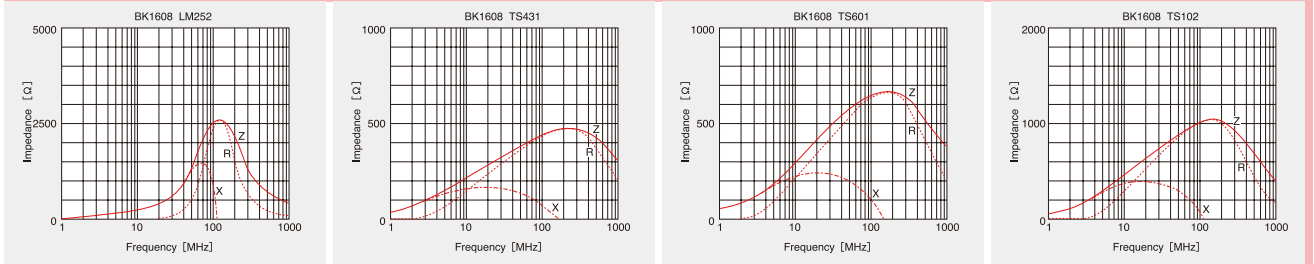
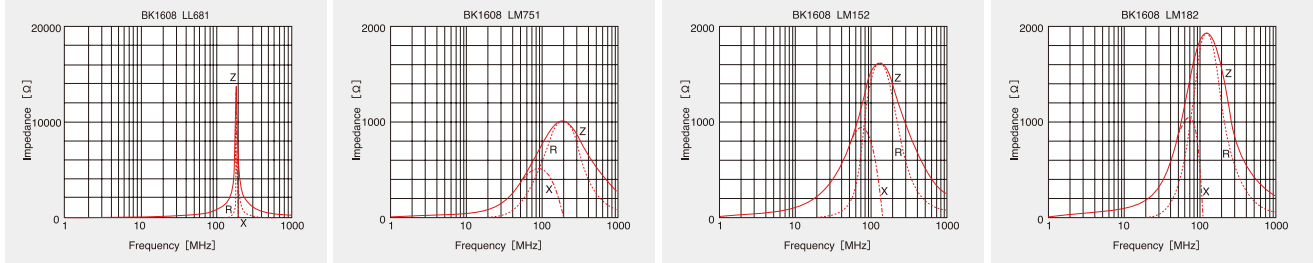
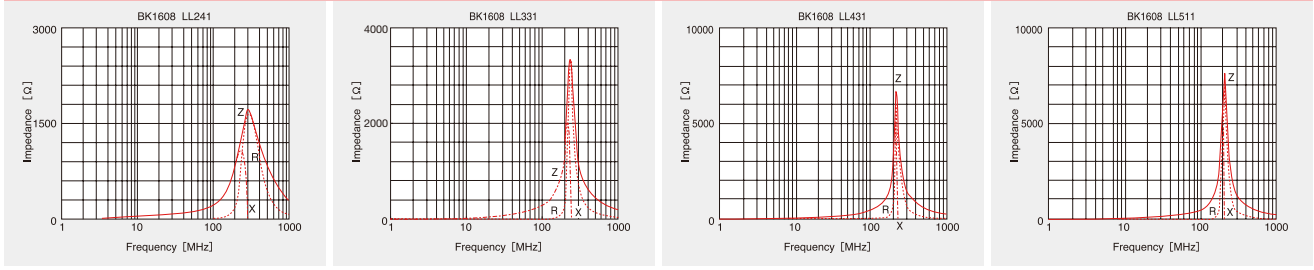

BK2125

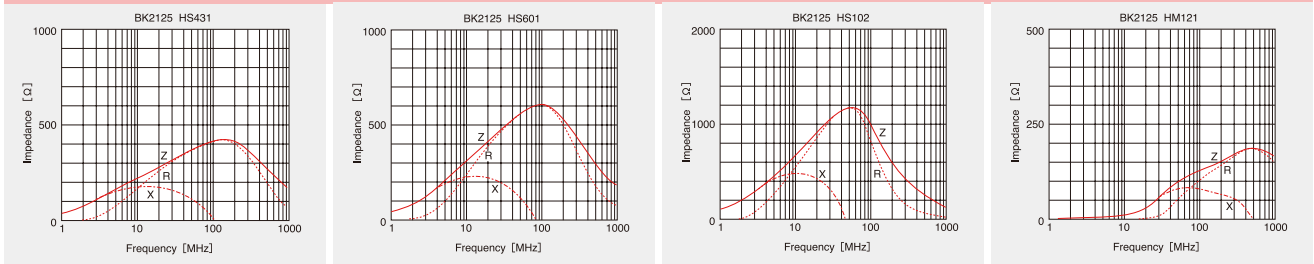
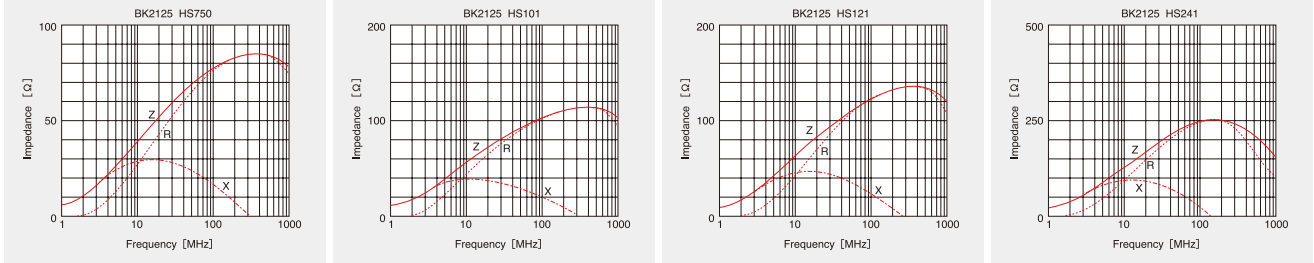
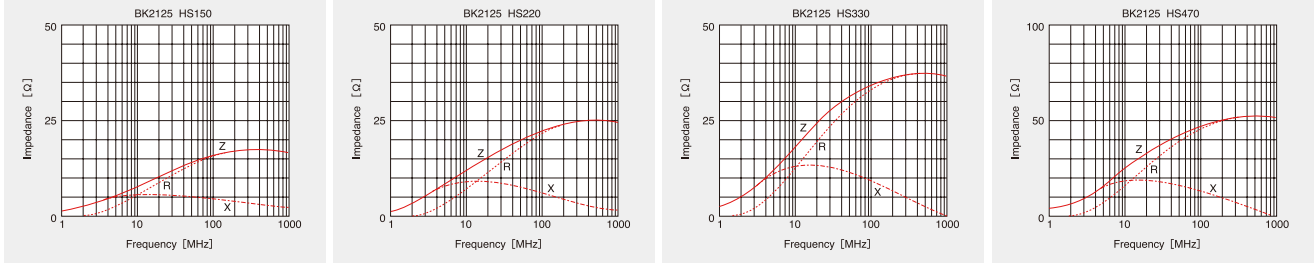

► This catalog contains the typical specification only due to the limitation of space. When you consider the purchase of our products, please check our specification. For details of each product (characteristics graph, reliability information, precautions for use, and so on), see our Web site (<http://www.ty-top.com/>).

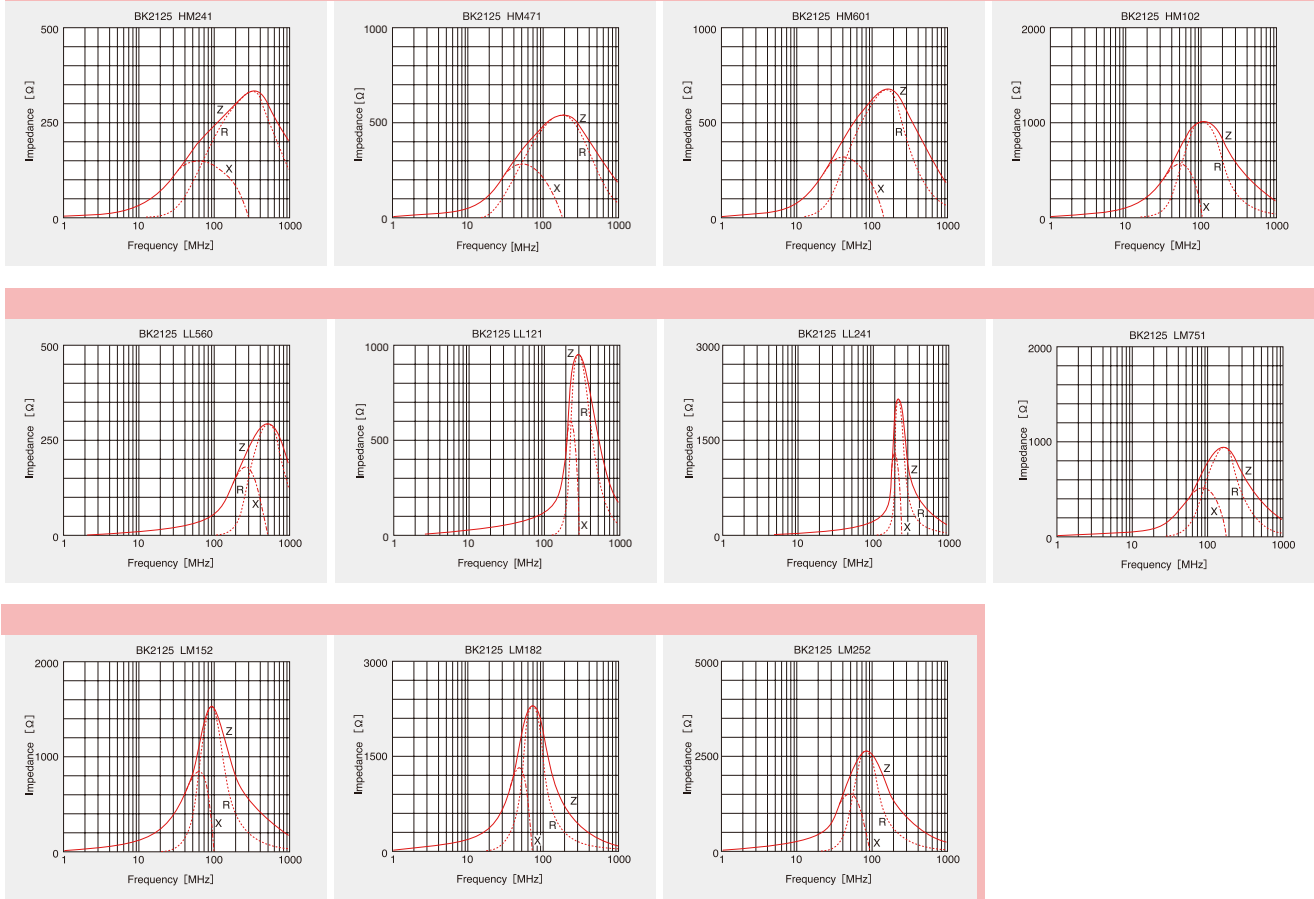

► This catalog contains the typical specification only due to the limitation of space. When you consider the purchase of our products, please check our specification. For details of each product (characteristics graph, reliability information, precautions for use, and so on), see our Web site (<http://www.ty-top.com/>).

MULTILAYER CHIP BEAD INDUCTORS(BK SERIES H TYPE)



REFLOW

■ PARTS NUMBER

* Operating Temp.: -55~+125°C

B	K	H	1	0	0	5	L	M	1	8	2	-	T	△
①			②				③		④			⑤	⑥	⑦

△=Blank space

①Series name

Code	Series name
BKH	Multilayer chip bead inductor H type

②Dimensions (L × W)

Code	Type (inch)	Dimensions (L × W) [mm]
0603	0603 (0201)	0.6 × 0.3
1005	1005 (0402)	1.0 × 0.5

③Material

Code	Material
LM	Refer to impedance curves for material differences
HL	

④Nominal impedance

Code (example)	Nominal impedance [Ω]
250	25
221	220
102	1000

⑤Characteristics

Code	Characteristics
-	Standard

⑥Packaging

Code	Packaging
T	Taping

⑦Internal code

Code	Internal code
△	Standard

■ STANDARD EXTERNAL DIMENSIONS / STANDARD QUANTITY

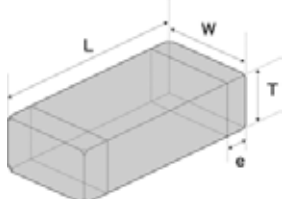

Type	L	W	T	e	Standard quantity [pcs]	
					Paper tape	Embossed tape
BKH0603 (0201)	0.60 ± 0.03 (0.024 ± 0.001)	0.30 ± 0.03 (0.012 ± 0.001)	0.30 ± 0.03 (0.012 ± 0.001)	0.15 ± 0.05 (0.006 ± 0.002)	15000	-
BKH1005 (0402)	1.00 ± 0.05 (0.039 ± 0.002)	0.50 ± 0.05 (0.020 ± 0.002)	0.50 ± 0.05 (0.020 ± 0.002)	0.25 ± 0.10 (0.010 ± 0.004)	10000	-

Unit: mm (inch)

■ PARTS NUMBER

● BKH0603

Parts number	EHS	Measuring frequency 100MHz		Measuring frequency 1GHz		DC Resistance [Ω] (max.)	Rated current [mA] (max.)	Thickness [mm]
		Nominal impedance [Ω]	Impedance tolerance	Nominal impedance [Ω]	Impedance tolerance			
BKH0603LM601-T	RoHS	600	±25%	1250	±40%	1.50	160	0.30 ± 0.03
BKH0603LM102-T	RoHS	1000	±25%	1900	±40%	2.50	130	0.30 ± 0.03
BKH0603LM152-T	RoHS	1500	±25%	2700	±40%	3.20	115	0.30 ± 0.03
BKH0603HL250-T	RoHS	25	±25%	135	±40%	0.26	450	0.30 ± 0.03
BKH0603HL500-T	RoHS	50	±25%	255	±40%	0.58	300	0.30 ± 0.03
BKH0603HL221-T	RoHS	220	±25%	1200	±40%	2.00	150	0.30 ± 0.03

● BKH1005

Parts number	EHS	Measuring frequency 100MHz		Measuring frequency 1GHz		DC Resistance [Ω] (max.)	Rated current [mA] (max.)	Thickness [mm]
		Nominal impedance [Ω]	Impedance tolerance	Nominal impedance [Ω]	Impedance tolerance			
BKH1005LM601-T	RoHS	600	±25%	1300	±40%	0.85	300	0.50 ± 0.05
BKH1005LM102-T	RoHS	1000	±25%	1700	±40%	1.25	250	0.50 ± 0.05
BKH1005LM152-T	RoHS	1500	±25%	2300	±40%	1.50	200	0.50 ± 0.05
BKH1005LM182-T	RoHS	1800	±25%	2700	±40%	2.00	200	0.50 ± 0.05

▶ This catalog contains the typical specification only due to the limitation of space. When you consider the purchase of our products, please check our specification. For details of each product (characteristics graph, reliability information, precautions for use, and so on), see our Web site (<http://www.ty-top.com/>).

BKH0603

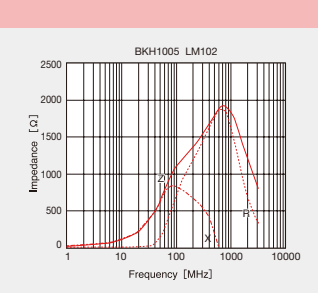
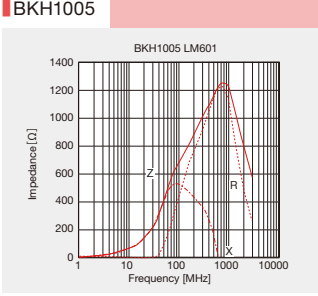
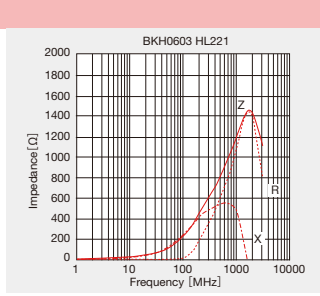
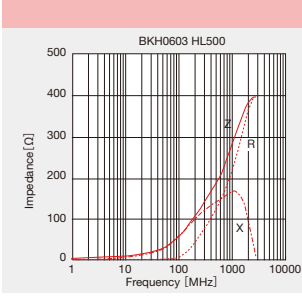
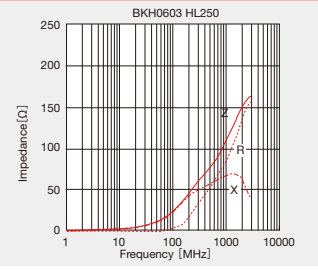
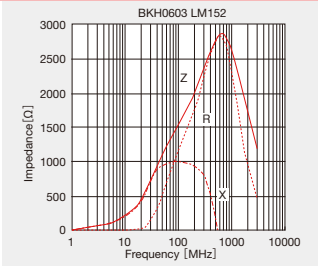
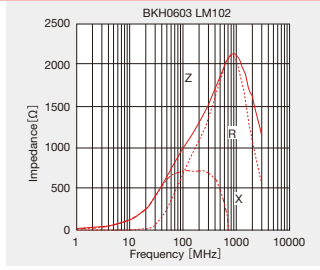
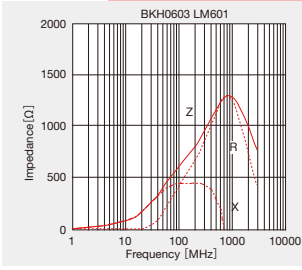

BKH1005

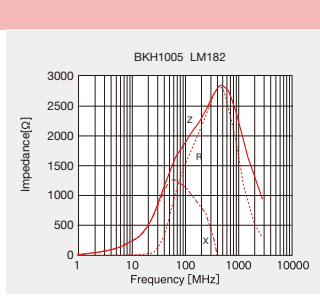
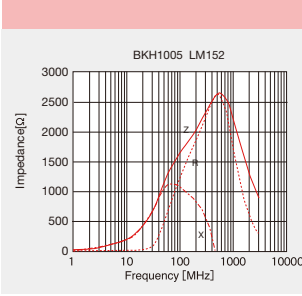

► This catalog contains the typical specification only due to the limitation of space. When you consider the purchase of our products, please check our specification. For details of each product (characteristics graph, reliability information, precautions for use, and so on), see our Web site (<http://www.ty-top.com/>).

MULTILAYER CHIP BEAD INDUCTORS (BK ARRAY SERIES)



REFLOW

■ PARTS NUMBER

* Operating Temp.: -55~+125°C

B	K	△	3	2	1	6	4	S	6	0	1	-	T	△
①			②				③		④				⑤	⑥

△=Blank space

① Series name

Code	Series name
BK△	Multilayer chip bead inductor

② Dimensions (L × W)

Code	Type (inch)	Dimensions (L × W) [mm]
2010	2010 (0804)	2.0 × 1.0
3216	3216 (1206)	3.2 × 1.6

③ Material

Code	Material
4W	Refer to impedance curves for material differences
4S	
4M	
4L	

④ Nominal impedance

Code (example)	Nominal impedance [Ω]
601	600
102	1000

⑤ Packaging

Code	Packaging
-T	Taping

⑥ Internal code

Code	Internal code
△	Standard

■ STANDARD EXTERNAL DIMENSIONS / STANDARD QUANTITY

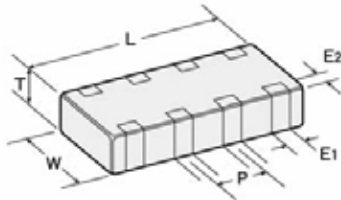

Type	L	W	T	E ₁	E ₂	P	Standard quantity [pcs]	
							Paper tape	Embossed tape
BK 2010 (0804)	2.0±0.15 (0.079±0.006)	1.0±0.15 (0.039±0.006)	0.45±0.05 (0.018±0.002)	0.25+0.15/-0.1 (0.010+0.006/-0.004)	0.25±0.15 (0.010±0.006)	0.5±0.1 (0.020±0.004)	4000	-
BK 3216 (1206)	3.2±0.2 (0.126±0.008)	1.6±0.2 (0.063±0.008)	0.8±0.1 (0.031±0.004)	0.35±0.2 (0.014±0.008)	0.3±0.2 (0.012±0.008)	0.8±0.1 (0.031±0.004)	-	4000

Unit: mm (inch)

► This catalog contains the typical specification only due to the limitation of space. When you consider the purchase of our products, please check our specification. For details of each product (characteristics graph, reliability information, precautions for use, and so on), see our Web site (<http://www.ty-top.com/>).

■ PARTS NUMBER

● BK 2010

Parts number	EHS	Nominal impedance [Ω]	Impedance tolerance	Measuring frequency [MHz]	DC Resistance [Ω] (max.)	Rated current [mA] (max.)
BK 20104W680-T	RoHS	68	±25%	100	0.35	100
BK 20104W121-T	RoHS	120	±25%	100	0.40	100
BK 20104W241-T	RoHS	240	±25%	100	0.50	100
BK 20104S121-T	RoHS	120	±25%	100	0.30	100
BK 20104S241-T	RoHS	240	±25%	100	0.45	100
BK 20104S431-T	RoHS	430	±25%	100	0.55	100
BK 20104S601-T	RoHS	600	±25%	100	0.70	100
BK 20104M121-T	RoHS	120	±25%	100	0.30	100
BK 20104M241-T	RoHS	240	±25%	100	0.45	100
BK 20104M431-T	RoHS	430	±25%	100	0.55	100
BK 20104M601-T	RoHS	600	±25%	100	0.70	100
BK 20104M102-T	RoHS	1000	±25%	100	0.80	100
BK 20104L050-T	RoHS	5	±25%	100	0.10	100
BK 20104L100-T	RoHS	10	±25%	100	0.15	100
BK 20104L220-T	RoHS	22	±25%	100	0.20	100
BK 20104L330-T	RoHS	33	±25%	100	0.30	100
BK 20104L470-T	RoHS	47	±25%	100	0.40	100
BK 20104L680-T	RoHS	68	±25%	100	0.50	100
BK 20104L121-T	RoHS	120	±25%	100	0.70	100
BK 20104L181-T	RoHS	180	±25%	100	0.90	100

● BK 3216

Parts number	EHS	Nominal impedance [Ω]	Impedance tolerance	Measuring frequency [MHz]	DC Resistance [Ω] (max.)	Rated current [mA] (max.)
BK 32164W121-T	RoHS	120	±25%	100	0.15	100
BK 32164W241-T	RoHS	240	±25%	100	0.25	100
BK 32164W431-T	RoHS	430	±25%	100	0.35	100
BK 32164W601-T	RoHS	600	±25%	100	0.40	100
BK 32164S600-T	RoHS	60	±25%	100	0.18	200
BK 32164S121-T	RoHS	120	±25%	100	0.18	200
BK 32164S241-T	RoHS	240	±25%	100	0.30	200
BK 32164S301-T	RoHS	300	±25%	100	0.40	200
BK 32164S471-T	RoHS	470	±25%	100	0.40	200
BK 32164S601-T	RoHS	600	±25%	100	0.45	200
BK 32164S102-T	RoHS	1000	±25%	100	0.68	100
BK 32164M121-T	RoHS	120	±25%	100	0.20	150
BK 32164M241-T	RoHS	240	±25%	100	0.35	150
BK 32164M301-T	RoHS	300	±25%	100	0.45	150
BK 32164M471-T	RoHS	470	±25%	100	0.50	150
BK 32164M601-T	RoHS	600	±25%	100	0.60	100
BK 32164M102-T	RoHS	1000	±25%	100	0.80	100
BK 32164L680-T	RoHS	68	±25%	100	0.35	200
BK 32164L121-T	RoHS	120	±25%	100	0.55	200
BK 32164L181-T	RoHS	180	±25%	100	0.65	150
BK 32164L241-T	RoHS	240	±25%	100	0.75	150

► This catalog contains the typical specification only due to the limitation of space. When you consider the purchase of our products, please check our specification. For details of each product (characteristics graph, reliability information, precautions for use, and so on), see our Web site (<http://www.ty-top.com/>).

BK2010

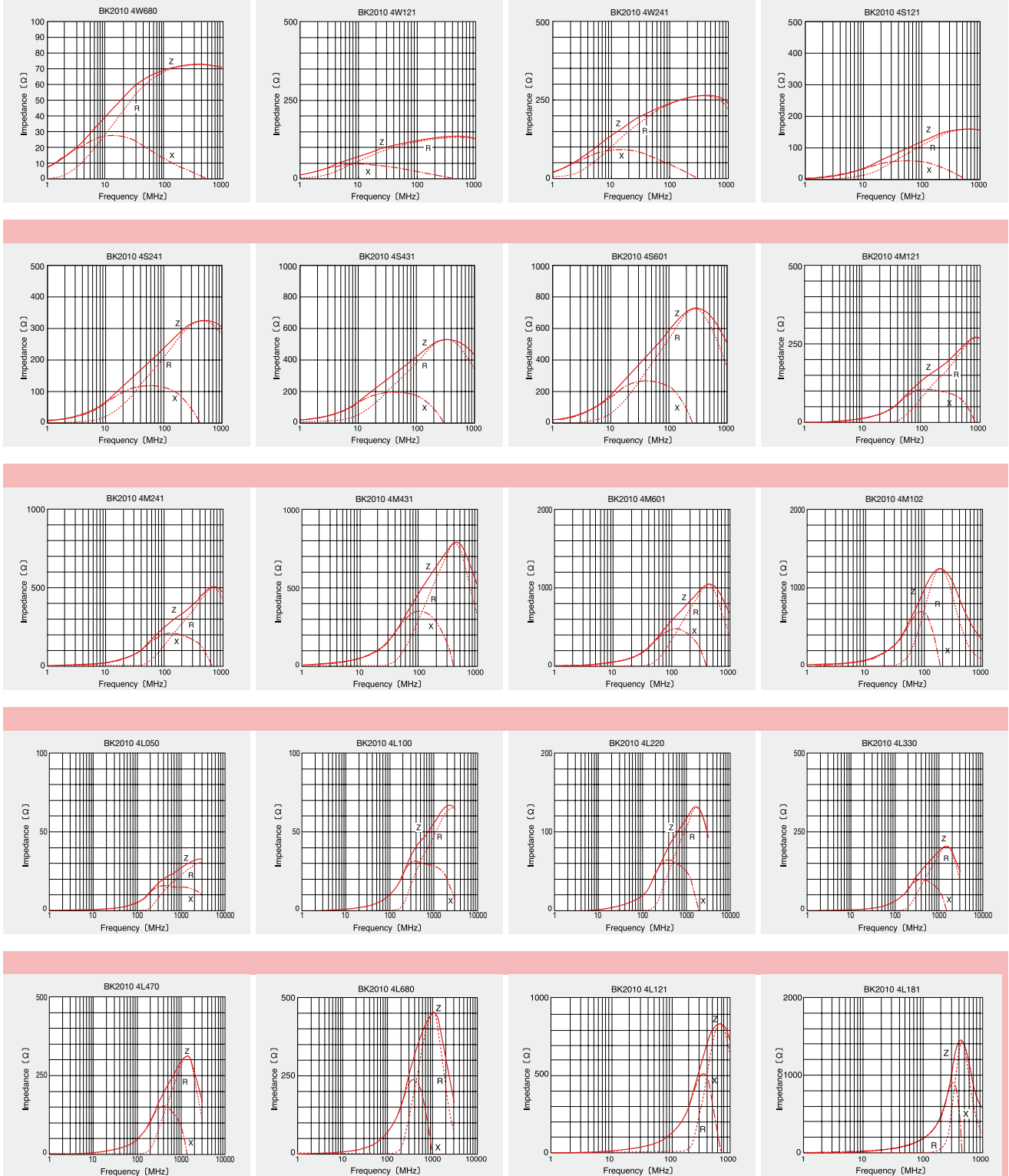

► This catalog contains the typical specification only due to the limitation of space. When you consider the purchase of our products, please check our specification. For details of each product (characteristics graph, reliability information, precautions for use, and so on), see our Web site (<http://www.ty-top.com/>).

BK3216

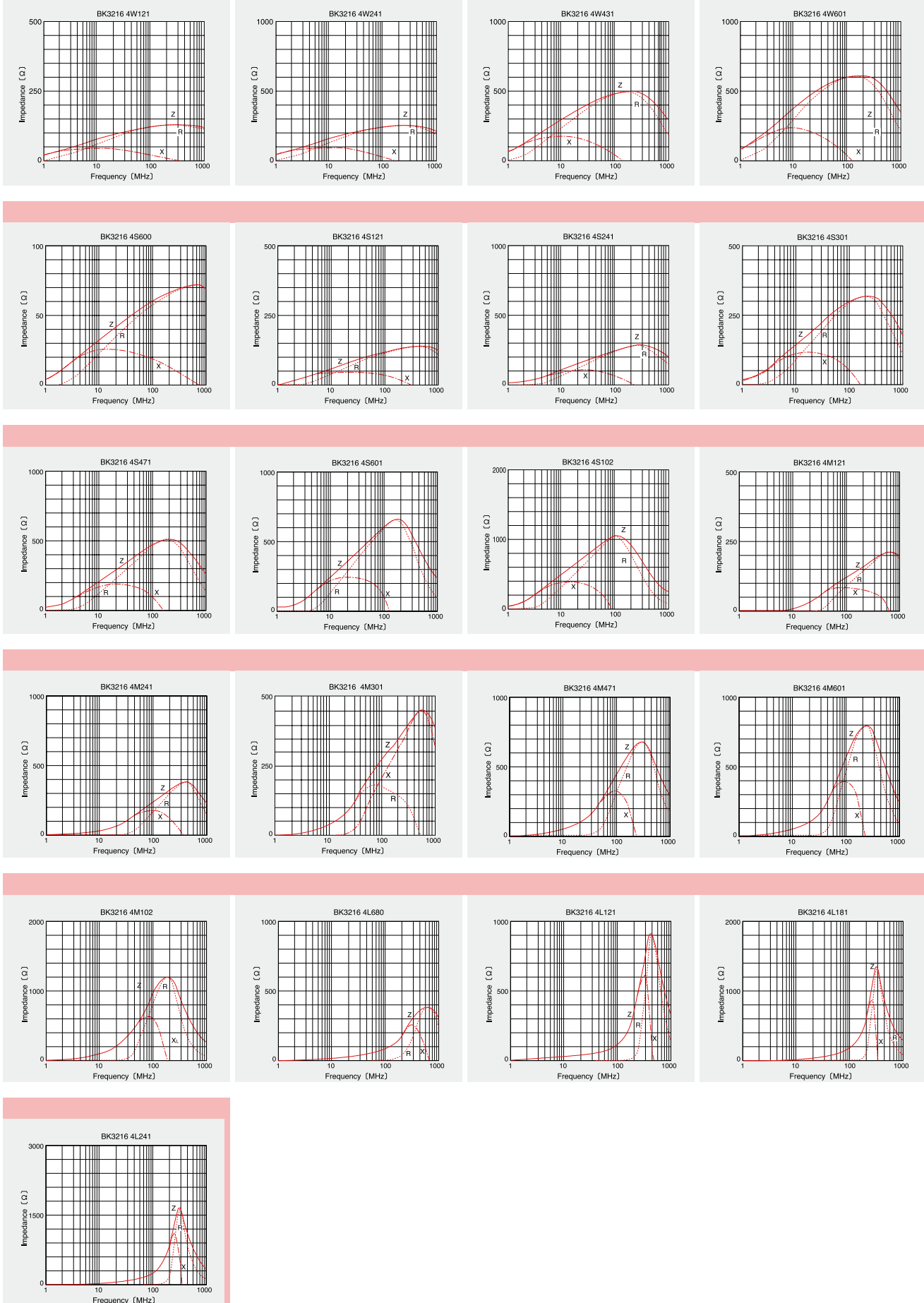

► This catalog contains the typical specification only due to the limitation of space. When you consider the purchase of our products, please check our specification. For details of each product (characteristics graph, reliability information, precautions for use, and so on), see our Web site (<http://www.ty-top.com/>).

MULTILAYER CHIP BEAD INDUCTORS FOR POWER LINES(BK SERIES P TYPE)



WAVE* REFLOW

*Except for BKP0603, BKP1005

■ PARTS NUMBER

* Operating Temp.: -55~+85°C

B	K	P	1	6	0	8	H	S	1	8	1	-	T	△
①	②	③	④	⑤	⑥	⑦								

△ = Blank space

① Series name

Code	Series name
BKP	Multilayer chip bead inductor for power line

② Dimensions (L × W)

Code	Type (inch)	Dimensions (L × W) [mm]
0402	0402 (01005)	0.4 × 0.2
0603	0603 (0201)	0.6 × 0.3
1005	1005 (0402)	1.0 × 0.5
1608	1608 (0603)	1.6 × 0.8
2125	2125 (0805)	2.0 × 1.25

③ Material

Code	Material
HS	Refer to impedance curves for material differences
HM	
TS	
TM	
EM	

④ Nominal impedance

Code (example)	Nominal impedance [Ω]
330	33
101	100
391	390

⑤ Characteristics

Code	Characteristics
-	Standard

⑥ Packaging

Code	Packaging
T	Taping

⑦ Internal code

Code	Internal code
△	Standard

■ STANDARD EXTERNAL DIMENSIONS / STANDARD QUANTITY

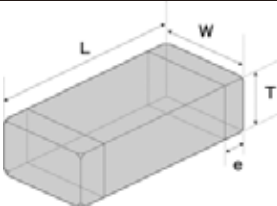

Type	L	W	T	e	Standard quantity [pcs]	
					Paper tape	Embossed tape
BKP0402 (01005)	0.40 ± 0.02 (0.016 ± 0.001)	0.20 ± 0.02 (0.008 ± 0.001)	0.20 ± 0.02 (0.008 ± 0.001)	0.10 + 0.04 / - 0.03 (0.004 + 0.002 / - 0.001)	20000	-
BKP0603 (0201)	0.6 ± 0.03 (0.024 ± 0.001)	0.3 ± 0.03 (0.012 ± 0.001)	0.3 ± 0.03 (0.012 ± 0.001)	0.15 ± 0.05 (0.006 ± 0.002)	15000	-
BKP1005 (0402)	1.0 ± 0.05 (0.039 ± 0.002)	0.5 ± 0.05 (0.020 ± 0.002)	0.5 ± 0.05 (0.020 ± 0.002)	0.25 ± 0.1 (0.010 ± 0.004)	10000	-
BKP1608 (0603)	1.6 ± 0.15 (0.063 ± 0.006)	0.8 ± 0.15 (0.031 ± 0.006)	0.8 ± 0.15 (0.031 ± 0.006)	0.3 ± 0.2 (0.012 ± 0.008)	4000	-
BKP2125 (0805)	2.0 + 0.3 / - 0.1 (0.079 + 0.012 / - 0.004)	1.25 ± 0.2 (0.049 ± 0.008)	0.85 ± 0.2 (0.033 ± 0.008)	0.5 ± 0.3 (0.020 ± 0.012)	4000	-

Unit: mm (inch)

► This catalog contains the typical specification only due to the limitation of space. When you consider the purchase of our products, please check our specification. For details of each product (characteristics graph, reliability information, precautions for use, and so on), see our Web site (<http://www.ty-top.com/>).

■ PARTS NUMBER

● BKP0402

Parts number	EHS	Nominal impedance [Ω]	Impedance tolerance	Measuring frequency [MHz]	DC Resistance [mΩ] (max.)	Rated current [A] (max.)	Thickness [mm]
BKP0402HM100-T	RoHS	10	±5Ω	100	50	1.1	0.20 ±0.02
BKP0402HM220-T	RoHS	22	±25%	100	110	0.75	0.20 ±0.02
BKP0402HM330-T	RoHS	33	±25%	100	150	0.55	0.20 ±0.02

● BKP0603

Parts number	EHS	Nominal impedance [Ω]	Impedance tolerance	Measuring frequency [MHz]	DC Resistance [mΩ] (max.)	Rated current [A] (max.)	Thickness [mm]
BKP0603HS100-T	RoHS	10	±5Ω	100	30	1.3	0.30 ±0.03
BKP0603HS220-T	RoHS	22	±25%	100	65	1.0	0.30 ±0.03
BKP0603HS330-T	RoHS	33	±25%	100	70	1.0	0.30 ±0.03
BKP0603HS800-T	RoHS	80	±25%	100	120	1.0	0.30 ±0.03
BKP0603HS121-T	RoHS	120	±25%	100	150	0.85	0.30 ±0.03
BKP0603HM100-T	RoHS	10	±5Ω	100	30	1.3	0.30 ±0.03
BKP0603HM220-T	RoHS	22	±25%	100	70	1.0	0.30 ±0.03
BKP0603HM330-T	RoHS	33	±25%	100	70	1.0	0.30 ±0.03
BKP0603HM800-T	RoHS	80	±25%	100	120	1.0	0.30 ±0.03
BKP0603HM121-T	RoHS	120	±25%	100	180	0.80	0.30 ±0.03
BKP0603TS220-T	RoHS	22	±25%	100	40	1.8	0.30 ±0.03
BKP0603TS330-T	RoHS	33	±25%	100	55	1.5	0.30 ±0.03
BKP0603TM220-T	RoHS	22	±25%	100	40	1.8	0.30 ±0.03
BKP0603TM330-T	RoHS	33	±25%	100	55	1.5	0.30 ±0.03

● BKP1005

Parts number	EHS	Nominal impedance [Ω]	Impedance tolerance	Measuring frequency [MHz]	DC Resistance [mΩ] (max.)	Rated current [A] (max.)	Thickness [mm]
BKP1005EM100-T	RoHS	10	±5Ω	100	30	2.4	0.50 ±0.05
BKP1005EM300-T	RoHS	30	±25%	100	35	2.2	0.50 ±0.05
BKP1005EM600-T	RoHS	60	±25%	100	60	1.7	0.50 ±0.05
BKP1005EM121-T	RoHS	120	±25%	100	85	1.55	0.50 ±0.05
BKP1005EM221-T	RoHS	220	±25%	100	150	1.00	0.50 ±0.05
BKP1005EM331-T	RoHS	330	±25%	100	220	0.80	0.50 ±0.05
BKP1005HS100-T	RoHS	10	±25%	100	30	2.0	0.50 ±0.05
BKP1005HS330-T	RoHS	33	±25%	100	50	1.7	0.50 ±0.05
BKP1005HS680-T	RoHS	68	±25%	100	75	1.5	0.50 ±0.05
BKP1005HS121-T	RoHS	120	±25%	100	140	1.0	0.50 ±0.05
BKP1005HS221-T	RoHS	220	±25%	100	200	0.80	0.50 ±0.05
BKP1005HM121-T	RoHS	120	±25%	100	120	1.1	0.50 ±0.05
BKP1005HM221-T	RoHS	220	±25%	100	180	0.90	0.50 ±0.05
BKP1005TS330-T	RoHS	33	±25%	100	39±30%	1.7	0.50 ±0.05
BKP1005TS680-T	RoHS	68	±25%	100	55±30%	1.5	0.50 ±0.05
BKP1005TS121-T	RoHS	120	±25%	100	70±30%	1.3	0.50 ±0.05
BKP1005TM121-T	RoHS	120	±25%	100	100	1.3	0.50 ±0.05

● BKP1608

Parts number	EHS	Nominal impedance [Ω]	Impedance tolerance	Measuring frequency [MHz]	DC Resistance [mΩ] (max.)	Rated current [A] (max.)	Thickness [mm]
BKP1608HS330-T	RoHS	33	±25%	100	25	3.0	0.80 ±0.15
BKP1608HS600-T	RoHS	60	±25%	100	40	2.5	0.80 ±0.15
BKP1608HS101-T	RoHS	100	±25%	100	50	1.7	0.80 ±0.15
BKP1608HS121-T	RoHS	120	±25%	100	35	2.7	0.80 ±0.15
BKP1608HS181-T	RoHS	180	±25%	100	75	1.5	0.80 ±0.15
BKP1608HS271-T	RoHS	270	±25%	100	110	1.2	0.80 ±0.15
BKP1608HS391-T	RoHS	390	±25%	100	140	1.0	0.80 ±0.15
BKP1608HS471-T	RoHS	470	±25%	100	180	1.0	0.80 ±0.15

● BKP2125

Parts number	EHS	Nominal impedance [Ω]	Impedance tolerance	Measuring frequency [MHz]	DC Resistance [mΩ] (max.)	Rated current [A] (max.)	Thickness [mm]
BKP2125HS330-T	RoHS	33	±25%	100	20	4.0	0.85 ±0.2
BKP2125HS600-T	RoHS	60	±25%	100	25	3.0	0.85 ±0.2
BKP2125HS101-T	RoHS	100	±25%	100	40	2.5	0.85 ±0.2
BKP2125HS221-T	RoHS	220	±25%	100	50	2.0	0.85 ±0.2
BKP2125HS331-T	RoHS	330	±25%	100	75	1.5	0.85 ±0.2

▶ This catalog contains the typical specification only due to the limitation of space. When you consider the purchase of our products, please check our specification. For details of each product (characteristics graph, reliability information, precautions for use, and so on), see our Web site (<http://www.ty-top.com/>).

BKP0402

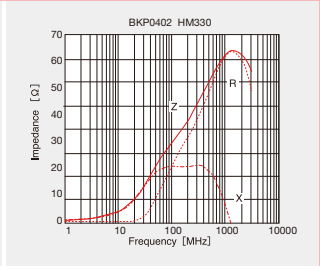
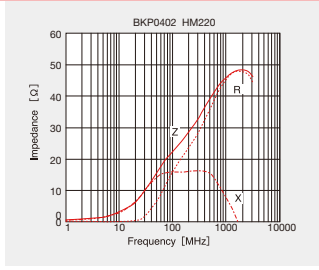
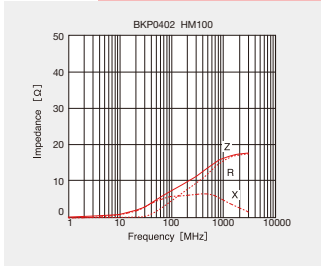

BKP0603

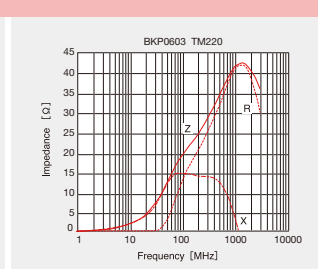
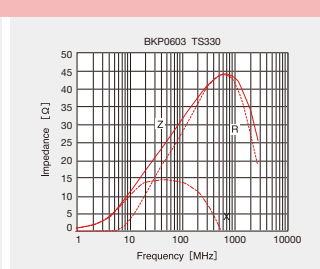
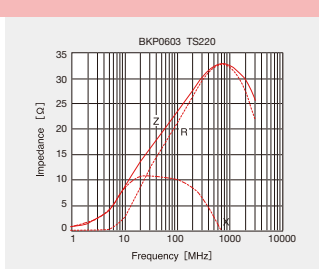
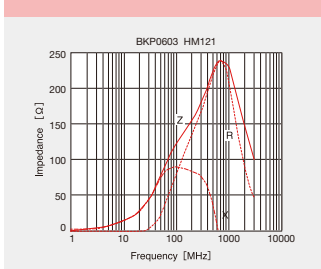
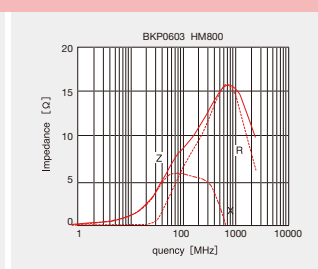
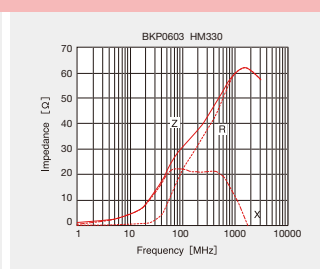
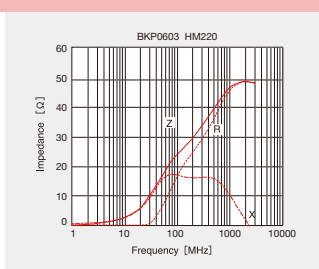
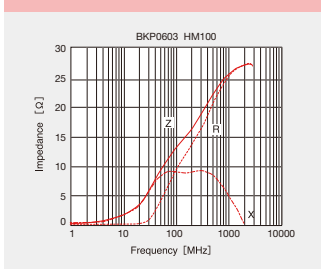
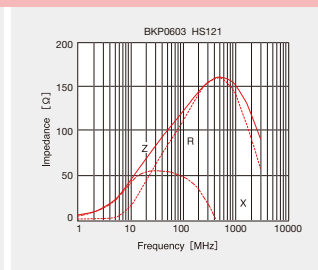
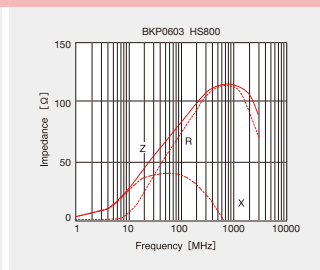
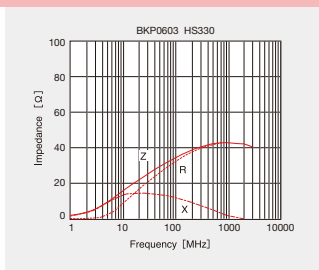
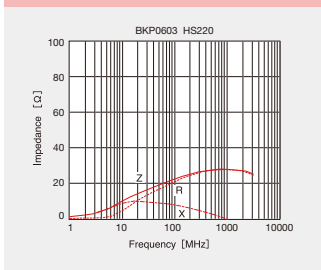
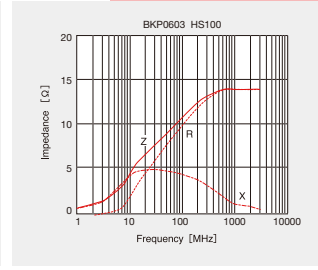

BKP1005

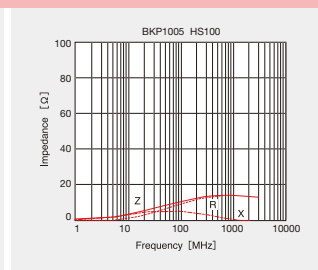
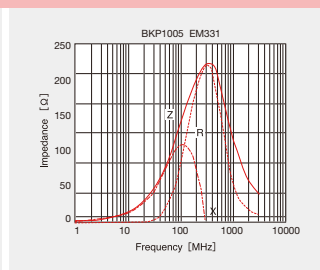
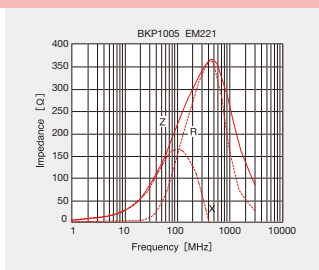
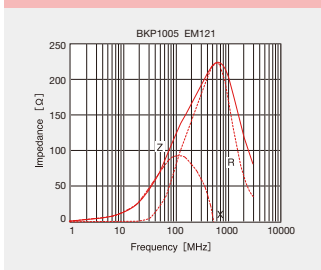
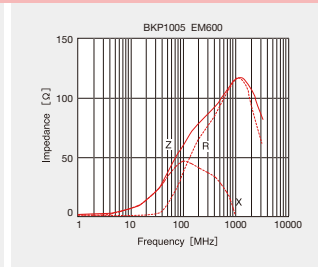
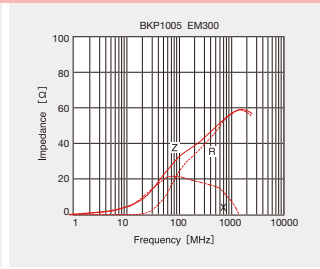
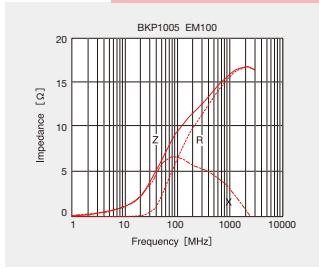
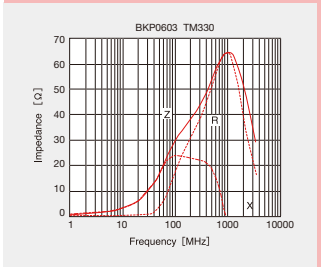

▶ This catalog contains the typical specification only due to the limitation of space. When you consider the purchase of our products, please check our specification. For details of each product (characteristics graph, reliability information, precautions for use, and so on), see our Web site (<http://www.ty-top.com/>).



▶ This catalog contains the typical specification only due to the limitation of space. When you consider the purchase of our products, please check our specification. For details of each product (characteristics graph, reliability information, precautions for use, and so on), see our Web site (<http://www.ty-top.com/>).

Multilayer chip inductors

Multilayer chip inductors for high frequency, Multilayer chip bead inductors

Multilayer common mode choke coils (MC series F type)

Metal Multilayer Chip Power Inductors (MCOIL™ MC series)

PACKAGING

① Minimum Quantity

● Tape & Reel Packaging

Type	Thickness mm (inch)	Standard Quantity [pcs]	
		Paper Tape	Embossed Tape
CK1608(0603)	0.8 (0.031)	4000	—
CK2125(0805)	0.85(0.033)	4000	—
	1.25(0.049)	—	2000
CKS2125(0805)	0.85(0.033)	4000	—
	1.25(0.049)	—	2000
CKP1608(0603)	0.8 (0.031)	4000	—
CKP2012(0805)	0.9 (0.035)	—	3000
CKP2016(0806)	0.9 (0.035)	—	3000
CKP2520(1008)	0.7 (0.028)	—	3000
	0.9 (0.035)	—	3000
	1.1 (0.043)	—	2000
NM2012(0805)	0.9 (0.035)	—	3000
NM2520(1008)	0.9 (0.035)	—	3000
	1.1 (0.043)	—	2000
LK1005(0402)	0.5 (0.020)	10000	—
LK1608(0603)	0.8 (0.031)	4000	—
LK2125(0805)	0.85(0.033)	4000	—
	1.25(0.049)	—	2000
HK0603(0201)	0.3 (0.012)	15000	—
HK1005(0402)	0.5 (0.020)	10000	—
HK1608(0603)	0.8 (0.031)	4000	—
HK2125(0805)	0.85(0.033)	—	4000
	1.0 (0.039)	—	3000
HKQ0402(01005)	0.2 (0.008)	20000	40000
HKQ0603W(0201)	0.3 (0.012)	15000	—
HKQ0603C(0201)	0.3 (0.012)	15000	—
HKQ0603S(0201)	0.3 (0.012)	15000	—
HKQ0603U(0201)	0.3 (0.012)	15000	—
AQ105(0402)	0.5 (0.020)	10000	—
BK0402(01005)	0.2 (0.008)	20000	—
BK0603(0201)	0.3 (0.012)	15000	—
BK1005(0402)	0.5 (0.020)	10000	—
BKH0603(0201)	0.3 (0.012)	15000	—
BKH1005(0402)	0.5 (0.020)	10000	—
BK1608(0603)	0.8 (0.031)	4000	—
BK2125(0805)	0.85(0.033)	4000	—
	1.25(0.049)	—	2000
BK2010(0804)	0.45(0.018)	4000	—
BK3216(1206)	0.8 (0.031)	—	4000
BKP0402(01005)	0.2 (0.008)	20000	—
BKP0603(0201)	0.3 (0.012)	15000	—
BKP1005(0402)	0.5 (0.020)	10000	—
BKP1608(0603)	0.8 (0.031)	4000	—
BKP2125(0805)	0.85(0.033)	4000	—
MCF0605(0202)	0.3 (0.012)	15000	—
MCF0806(0302)	0.4 (0.016)	—	10000
MCF1210(0504)	0.55(0.022)	—	5000
MCF2010(0804)	0.45(0.018)	—	4000
MCFE1608(0603)	0.65(0.026)	4000	—
MCKK2012(0805)	1.00(0.039)	—	3000

▶ This catalog contains the typical specification only due to the limitation of space. When you consider the purchase of our products, please check our specification. For details of each product (characteristics graph, reliability information, precautions for use, and so on), see our Web site (<http://www.ty-top.com/>).

② Taping material

● Card board carrier tape

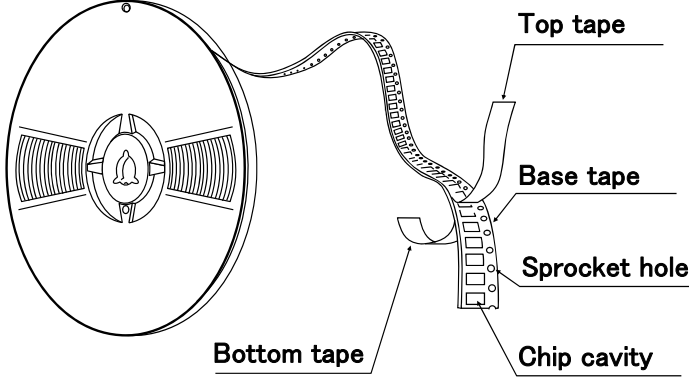

CK	1608
CKP	1608
CK	2125
CKS	2125
LK	1005
LK	1608
LK	2125
HK	0603
HK	1005
HK	1608
HKQ	0402
HKQ	0603
AQ	105

BK	0402
BK	0603
BK	1005
BK	1608
BK	2125
BK	2010
BKP	0402
BKP	0603
BKP	1005
BKP	1608
BKP	2125
BKH	0603
BKH	1005
MCF	0605
MC	1608

Chip Filled

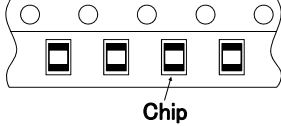

● Embossed Tape

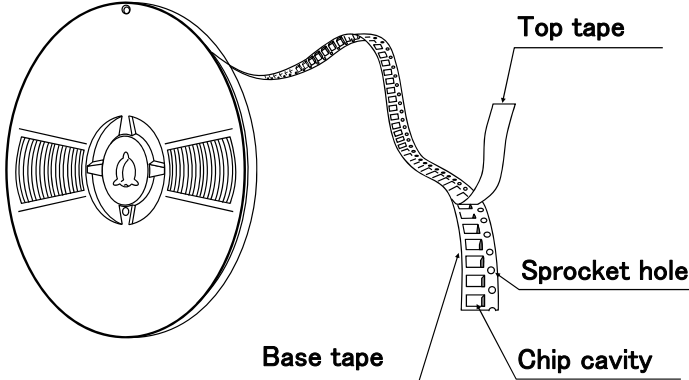

CK	2125
CKS	2125
CKP	2012
CKP	2016
CKP	2520
NM	2012
NM	2520
LK	2125
HKQ	0402
HK	2125

BK	2125
BK	3216
MCF	0806
MCF	1210
MCF	2010
MC	2012

Chip Filled

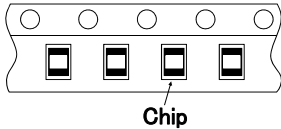

③ Taping Dimensions

● Paper tape (8mm wide)

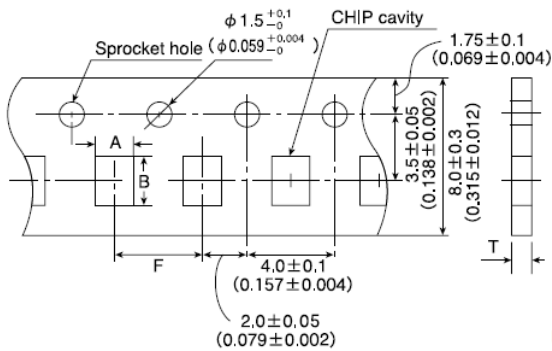

► This catalog contains the typical specification only due to the limitation of space. When you consider the purchase of our products, please check our specification. For details of each product (characteristics graph, reliability information, precautions for use, and so on), see our Web site (<http://www.ty-top.com/>).

Type	Thickness mm (inch)	Chip cavity		Insertion Pitch	Tape Thickness
		A	B	F	T
CK1608(0603)	0.8 (0.031)	1.0±0.2 (0.039±0.008)	1.8±0.2 (0.071±0.008)	4.0±0.1 (0.157±0.004)	1.1max (0.043max)
CK2125(0805)	0.85(0.033)	1.5±0.2 (0.059±0.008)	2.3±0.2 (0.091±0.008)	4.0±0.1 (0.157±0.004)	1.1max (0.043max)
CKS2125(0805)	0.85(0.033)	1.5±0.2 (0.059±0.008)	2.3±0.2 (0.091±0.008)	4.0±0.1 (0.157±0.004)	1.1max (0.043max)
CKP1608(0603)	0.8 (0.031)	1.0±0.2 (0.039±0.008)	1.8±0.2 (0.071±0.008)	4.0±0.1 (0.157±0.004)	1.1max (0.043max)
LK1005(0402)	0.5 (0.020)	0.65±0.1 (0.026±0.004)	1.15±0.1 (0.045±0.004)	2.0±0.05 (0.079±0.002)	0.8max (0.031max)
LK1608(0603)	0.8 (0.031)	1.0±0.2 (0.039±0.008)	1.8±0.2 (0.071±0.008)	4.0±0.1 (0.157±0.004)	1.1max (0.043max)
LK2125(0805)	0.85(0.033)	1.5±0.2 (0.059±0.008)	2.3±0.2 (0.091±0.008)	4.0±0.1 (0.157±0.004)	1.1max (0.043max)
HK0603(0201)	0.3 (0.012)	0.40±0.06 (0.016±0.002)	0.70±0.06 (0.028±0.002)	2.0±0.05 (0.079±0.002)	0.45max (0.018max)
HK1005(0402)	0.5 (0.020)	0.65±0.1 (0.026±0.004)	1.15±0.1 (0.045±0.004)	2.0±0.05 (0.079±0.002)	0.8max (0.031max)
HK1608(0603)	0.8 (0.031)	1.0±0.2 (0.039±0.008)	1.8±0.2 (0.071±0.008)	4.0±0.1 (0.157±0.004)	1.1max (0.043max)
HKQ0402(01005)	0.2 (0.008)	0.25±0.04 (0.010±0.002)	0.45±0.04 (0.018±0.002)	2.0±0.05 (0.079±0.002)	0.36max (0.014max)
HKQ0603W(0201)	0.3 (0.012)	0.40±0.06 (0.016±0.002)	0.70±0.06 (0.028±0.002)	2.0±0.05 (0.079±0.002)	0.45max (0.018max)
HKQ0603C(0201)	0.3 (0.012)	0.40±0.06 (0.016±0.002)	0.70±0.06 (0.028±0.002)	2.0±0.05 (0.079±0.002)	0.45max (0.018max)
HKQ0603S(0201)	0.3 (0.012)	0.40±0.06 (0.016±0.002)	0.70±0.06 (0.028±0.002)	2.0±0.05 (0.079±0.002)	0.45max (0.018max)
HKQ0603U(0201)	0.3 (0.012)	0.40±0.06 (0.016±0.002)	0.70±0.06 (0.028±0.002)	2.0±0.05 (0.079±0.002)	0.45max (0.018max)
AQ105(0402)	0.5 (0.020)	0.75±0.1 (0.030±0.004)	1.15±0.1 (0.045±0.004)	2.0±0.05 (0.079±0.002)	0.8max (0.031max)
BK0402(01005)	0.2 (0.008)	0.25±0.04 (0.010±0.002)	0.45±0.04 (0.018±0.002)	2.0±0.05 (0.079±0.002)	0.36max (0.014max)
BK0603(0201)	0.3 (0.012)	0.40±0.06 (0.016±0.002)	0.70±0.06 (0.028±0.002)	2.0±0.05 (0.079±0.002)	0.45max (0.018max)
BK1005(0402)	0.5 (0.020)	0.65±0.1 (0.026±0.004)	1.15±0.1 (0.045±0.004)	2.0±0.05 (0.079±0.002)	0.8max (0.031max)
BK1608(0603)	0.8 (0.031)	1.0±0.2 (0.039±0.008)	1.8±0.2 (0.071±0.008)	4.0±0.1 (0.157±0.004)	1.1max (0.043max)
BK2125(0805)	0.85(0.033)	1.5±0.2 (0.059±0.008)	2.3±0.2 (0.091±0.008)	4.0±0.1 (0.157±0.004)	1.1max (0.043max)
BK2010(0804)	0.45(0.018)	1.2±0.1 (0.047±0.004)	2.17±0.1 (0.085±0.004)	4.0±0.1 (0.157±0.004)	0.8max (0.031max)
BKP0402(01005)	0.2 (0.008)	0.25±0.04 (0.010±0.002)	0.45±0.04 (0.018±0.002)	2.0±0.05 (0.079±0.002)	0.36max (0.014max)
BKP0603(0201)	0.3 (0.012)	0.40±0.06 (0.016±0.002)	0.70±0.06 (0.028±0.002)	2.0±0.05 (0.079±0.002)	0.45max (0.018max)
BKP1005(0402)	0.5 (0.020)	0.65±0.1 (0.026±0.004)	1.15±0.1 (0.045±0.004)	2.0±0.05 (0.079±0.002)	0.8max (0.031max)
BKP1608(0603)	0.8 (0.031)	1.0±0.2 (0.039±0.008)	1.8±0.2 (0.071±0.008)	4.0±0.1 (0.157±0.004)	1.1max (0.043max)
BKP2125(0805)	0.85(0.033)	1.5±0.2 (0.059±0.008)	2.3±0.2 (0.091±0.008)	4.0±0.1 (0.157±0.004)	1.1max (0.043max)
BKH0603(0201)	0.3 (0.012)	0.40±0.06 (0.016±0.002)	0.70±0.06 (0.028±0.002)	2.0±0.05 (0.079±0.002)	0.45max (0.018max)
BKH1005(0402)	0.5 (0.020)	0.65±0.1 (0.026±0.004)	1.15±0.1 (0.045±0.004)	2.0±0.05 (0.079±0.002)	0.8max (0.031max)
MCF0605(0202)	0.3 (0.012)	0.62±0.03 (0.024±0.001)	0.77±0.03 (0.030±0.001)	2.0±0.05 (0.079±0.002)	0.45max (0.018max)
MCFE1608(0603)	0.65(0.026)	1.1±0.05 (0.043±0.002)	1.9±0.05 (0.075±0.002)	4.0±0.1 (0.157±0.004)	0.72max (0.028max)

Unit : mm (inch)

● Embossed Tape (8mm wide)

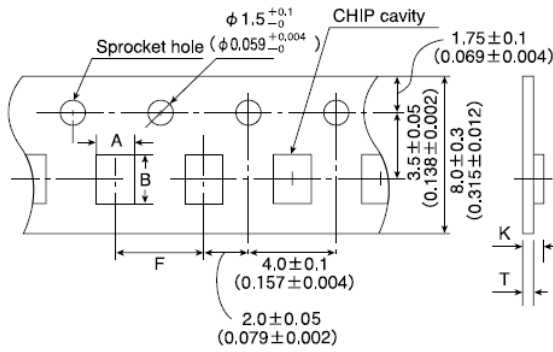

Unit : mm (inch)

Type	Thickness mm (inch)	Chip cavity		Insertion Pitch F	Tape Thickness	
		A	B		K	T
CK2125 (0805)	1.25 (0.049)	1.5 ± 0.2 (0.059 ± 0.008)	2.3 ± 0.2 (0.091 ± 0.008)	4.0 ± 0.1 (0.157 ± 0.004)	2.0 (0.079)	0.3 (0.012)
CKS2125 (0805)	1.25 (0.049)	1.5 ± 0.2 (0.059 ± 0.008)	2.3 ± 0.2 (0.091 ± 0.008)	4.0 ± 0.1 (0.157 ± 0.004)	2.0 (0.079)	0.3 (0.012)
CKP2012 (0805)	0.9 (0.035)	1.55 ± 0.2 (0.061 ± 0.008)	2.3 ± 0.2 (0.091 ± 0.008)	4.0 ± 0.1 (0.157 ± 0.004)	1.3 (0.051)	0.3 (0.012)
CKP2016 (0806)	0.9 (0.035)	1.8 ± 0.1 (0.071 ± 0.004)	2.2 ± 0.1 (0.087 ± 0.004)	4.0 ± 0.1 (0.157 ± 0.004)	1.3 (0.051)	0.25 (0.01)
CKP2520 (1008)	0.7 (0.028)	2.3 ± 0.1 (0.091 ± 0.004)	2.8 ± 0.1 (0.110 ± 0.004)	4.0 ± 0.1 (0.157 ± 0.004)	1.4 (0.055)	0.3 (0.012)
	0.9 (0.035)				1.4 (0.055)	
	1.1 (0.043)				1.7 (0.067)	
NM2012 (0805)	0.9 (0.035)	1.55 ± 0.2 (0.061 ± 0.008)	2.3 ± 0.2 (0.091 ± 0.008)	4.0 ± 0.1 (0.157 ± 0.004)	1.3 (0.051)	0.3 (0.012)
NM2520 (1008)	0.9 (0.035)	2.3 ± 0.1 (0.091 ± 0.004)	2.8 ± 0.1 (0.110 ± 0.004)	4.0 ± 0.1 (0.157 ± 0.004)	1.4 (0.055)	0.3 (0.012)
	1.1 (0.043)				1.7 (0.067)	
LK2125 (0805)	1.25 (0.049)	1.5 ± 0.2 (0.059 ± 0.008)	2.3 ± 0.2 (0.091 ± 0.008)	4.0 ± 0.1 (0.157 ± 0.004)	2.0 (0.079)	0.3 (0.012)
HK2125 (0805)	0.85 (0.033)	1.5 ± 0.2 (0.059 ± 0.008)	2.3 ± 0.2 (0.091 ± 0.008)	4.0 ± 0.1 (0.157 ± 0.004)	1.5 (0.059)	0.3 (0.012)
	1.0 (0.039)				2.0 (0.079)	
BK2125 (0805)	1.25 (0.049)	1.5 ± 0.2 (0.059 ± 0.008)	2.3 ± 0.2 (0.091 ± 0.008)	4.0 ± 0.1 (0.157 ± 0.004)	2.0 (0.079)	0.3 (0.012)
BK3216 (1206)	0.8 (0.031)	1.9 ± 0.1 (0.075 ± 0.004)	3.5 ± 0.1 (0.138 ± 0.004)	4.0 ± 0.1 (0.157 ± 0.004)	1.4 (0.055)	0.3 (0.012)
MCF0806 (0302)	0.4 (0.016)	0.75 ± 0.05 (0.030 ± 0.002)	0.95 ± 0.05 (0.037 ± 0.002)	2.0 ± 0.05 (0.079 ± 0.002)	0.55 (0.022)	0.3 (0.012)
MCF1210 (0504)	0.55 (0.022)	1.15 ± 0.05 (0.045 ± 0.002)	1.40 ± 0.05 (0.055 ± 0.002)	4.0 ± 0.1 (0.157 ± 0.004)	0.65 (0.026)	0.3 (0.012)
MCF2010 (0804)	0.45 (0.018)	1.1 ± 0.1 (0.043 ± 0.004)	2.3 ± 0.1 (0.091 ± 0.004)	4.0 ± 0.1 (0.157 ± 0.004)	0.85 (0.033)	0.3 (0.012)
MCKK2012 (0805)	1.0 (0.039)	1.55 ± 0.2 (0.061 ± 0.008)	2.3 ± 0.2 (0.091 ± 0.008)	4.0 ± 0.1 (0.157 ± 0.004)	1.3 (0.051)	0.25 (0.010)

Unit : mm (inch)

● Embossed Tape (4mm wide)

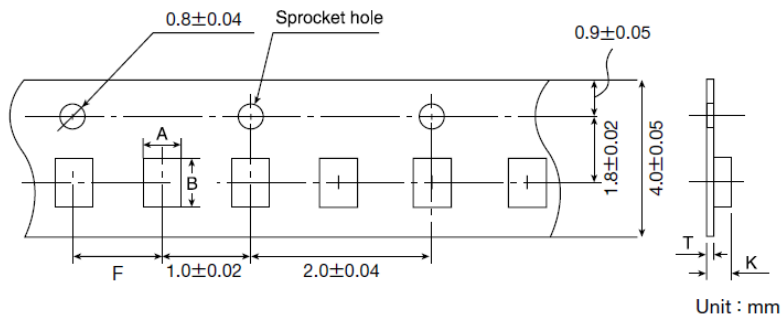

Unit : mm

Type	Thickness mm (inch)	Chip cavity		Insertion Pitch	Tape Thickness	
		A	B	F	K	T
HKQ0402 (01005)	0.2 (0.008)	0.23	0.43	1.0±0.02	0.5max.	0.25max.

Unit : mm

④ LEADER AND BLANK PORTION

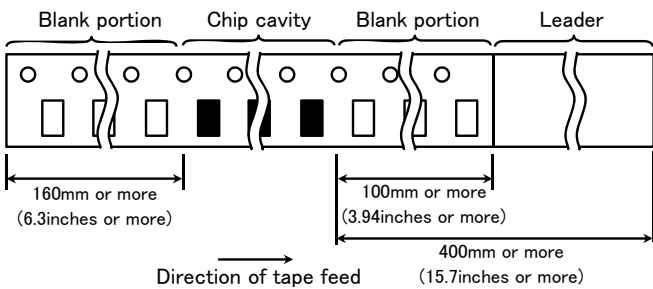

⑤ Reel Size

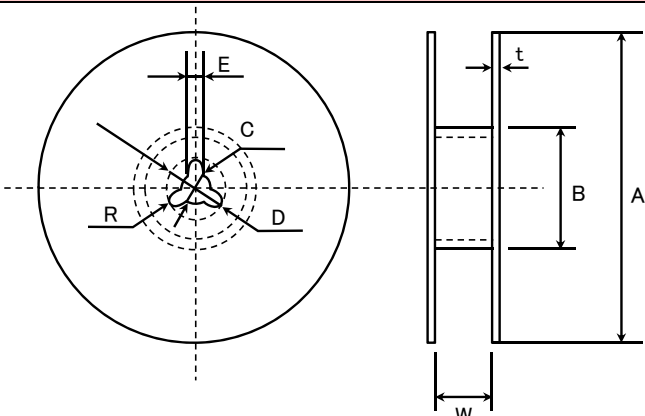

A	B	C	D	E	R
$\phi 178 \pm 2.0$	$\phi 50$ or more	$\phi 13.0 \pm 0.2$	$\phi 21.0 \pm 0.8$	2.0 ± 0.5	1.0

	t	W
4mm width tape	1.5max.	5 ± 1.0
8mm width tape	2.5max.	10 ± 1.5

(Unit : mm)

⑥ Top tape strength

The top tape requires a peel-off force of 0.1~0.7N in the direction of the arrow as illustrated below.

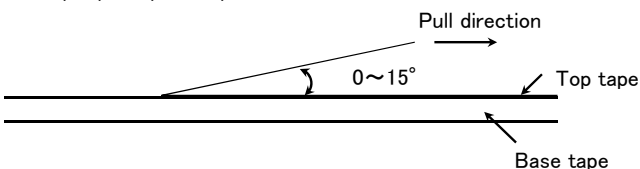

Multilayer chip inductors

Multilayer chip inductors for high frequency, Multilayer chip bead inductors

Multilayer common mode choke coils (MC series F type)

Metal Multilayer Chip Power Inductors (MCOIL™ MC series)

RELIABILITY DATA

1. Operating Temperature Range			
Specified Value	BK0402	-55~+125°C	
	BK0603		
	BK1005		
	BKH0603		
	BKH1005		
	BK1608		
	BK2125		
	ARRAY		BK2010
			BK3216
	BKP0402		-55~+85°C
	BKP0603		
	BKP1005		
	BKP1608		
	BKP2125		
	MCF 0605	-40~+85°C	
	MCF 0806		
	MCF 1210		
	MCF 2010		
	CK1608	-40~+85°C	
	CK2125		
	CKS2125		
	CKP1608		
	CKP2012		
	CKP2016		
	CKP2520		
	NM2012		
	NM2520		
	LK1005		-55~+125°C
	LK1608		
	LK2125		
	HKQ0402	-40~+85°C	
	HK0603		
HK1005	-55~+125°C		
HK1608			
HK2125			
HKQ0603W/HKQ0603C/HKQ0603S/ HKQ0603U/	-55~+125°C		
AQ105	-40~+125°C (Including self-generated heat)		
MCFE1608			
MCKK2012			

► This catalog contains the typical specification only due to the limitation of space. When you consider the purchase of our products, please check our specification.
For details of each product (characteristics graph, reliability information, precautions for use, and so on), see our Web site (<http://www.ty-top.com/>).

2. Storage Temperature Range

Specified Value	BK0402	-55~+125°C	
	BK0603		
	BK1005		
	BKH0603		
	BKH1005		
	BK1608		
	BK2125		
	ARRAY		BK2010
			BK3216
	BKP0402		-55~+85°C
	BKP0603		
	BKP1005		
	BKP1608		
	BKP2125		
	MCF 0605	-40~+85°C	
	MCF 0806		
	MCF 1210		
	MCF 2010		
	CK1608	-40~+85°C	
	CK2125		
CKS2125			
CKP1608			
CKP2012			
CKP2016			
CKP2520			
NM2012			
NM2520			
LK1005			
LK1608			
LK2125			
HKQ0402	-55~+125°C		
HK0603			
HK1005			
HK1608	-40~+85°C		
HK2125			
HKQ0603W/HKQ0603C/HKQ0603S/ HKQ0603U/	-55~+125°C		
AQ105			
MCFE1608	-40~+85°C		
MCKK2012			

3. Rated Current

Specified Value	BK0402	150~750mA DC	
	BK0603	100~500mA DC	
	BK1005	120~1000mA DC	
	BKH0603	115~450mA DC	
	BKH1005	200~300mA DC	
	BK1608	150~1500mA DC	
	BK2125	200~1200mA DC	
	ARRAY	BK2010	100mA DC
		BK3216	100~200mA DC
	BKP0402	0.55~1.1A DC	
	BKP0603	0.8~1.8A DC	
	BKP1005	0.8~2.4A DC	
	BKP1608	1.0~3.0A DC	
	BKP2125	1.5~4.0A DC	
	MCF 0605	0.05A DC	
	MCF 0806	0.1~0.13A DC	
	MCF 1210	0.1~0.15A DC	
	MCF 2010	0.1A DC	
	CK1608	50~60mA DC	
	CK2125	60~500mA DC	
	CKS2125	110~280mA DC	
	CKP1608	0.35~0.9A DC	
	CKP2012	0.7~1.7A DC	
	CKP2016	0.9~1.6A DC	
	CKP2520	1.1~1.8A DC	
	NM2012	1.0~1.2A DC	
	NM2520	0.9~1.2A DC	
	LK1005	20~25mA DC	
	LK1608	1~150mA DC	
	LK2125	5~300mA DC	
	HK0603	60~470mA DC	
	HK1005	110~300mA DC (-55~+125°C) 200~900mA DC (-55~+85°C)	
	HK1608	150~300mA DC	
	HK2125	300mA DC	
	HKQ0402	100~500mA DC	
	HKQ0603W	100~850mA DC	
	HKQ0603C	160~850mA DC	
	HKQ0603S	130~600mA DC	
	HKQ0603U	190~900mA DC	
	AQ105	280~710mA DC	
	MCFE1608	Idc1 : 1400~2600mA DC, Idc2 : 800~1500mA DC	
MCKK2012	Idc1 : 2000mA DC, Idc2 : 1400mA DC		

Definition of rated current:

- In the CK, CKS and BK Series, the rated current is the value of current at which the temperature of the element is increased within 20°C.
- In the BK Series P type, CK Series P type, NM Series, the rated current is the value of current at which the temperature of the element is increased within 40°C.
- In the LK, HK, HKQ0603, and AQ Series, the rated current is either the DC value at which the initial L value is decreased within 5% with the application of DC bias, or the value of current at which the temperature of the element is increased within 20°C.
- In the HKQ0402(~9N1), the rated current is either the DC value at which the initial L value is decreased within 5% with the application of DC bias, or the value of current at which the temperature of the element is increased within 20°C.
- In the HKQ0402(10N~), the rated current is either the DC value at which the initial L value is decreased within 5% with the application of DC bias, or the value of current at which the temperature of the element is increased within 25°C.
- In the MC Series, Idc1 is the DC value at which the initial L value is decreased within 30% and Idc2 is the DC value at which the temperature of element is increased within 40°C by the application of DC bias. (at 20°C)

4. Impedance

Specified Value	BK0402	10~330 Ω ±5 Ω(10 Ω), ±25%(Other)	
	BK0603	10~1200 Ω ±25%	
	BK1005	10~1800 Ω ±25%	
	BKH0603	25~1500 Ω ±25%	
	BKH1005	600~1800 Ω ±25%	
	BK1608	22~2500 Ω ±25%	
	BK2125	15~2500 Ω ±25%	
	ARRAY	BK2010	5~1000 Ω ±25%
		BK3216	60~1000 Ω ±25%
	BKP0402	10~33 Ω ±5 Ω(10 Ω), ±25%(Other)	
	BKP0603	10~120 Ω ±5 Ω(10 Ω), ±25%(Other)	
	BKP1005	10~330 Ω ±5 Ω(EM100), ±25%(Other)	
	BKP1608	33~470 Ω ±25%	
	BKP2125	33~330 Ω ±25%	
	MCF 0605	12~90 Ω ±5 Ω(12 Ω), ±20%(35 Ω), ±25%(Other)	
	MCF 0806	12~90 Ω ±5 Ω(12 Ω), ±20%(Other)	
	MCF 1210	40~90 Ω ±20%(2H900), ±25%(Other)	
	MCF 2010	90 Ω ±25%	
	CK1608		
	CK2125		
	CKS2125		
	CKP1608		
	CKP2012		
	CKP2016		
	CKP2520		
	NM2012		
	NM2520		
	LK1005		
	LK1608		
	LK2125		
	HKQ0402		
	HK0603		
	HK1005		
	HK1608		
	HK2125		
	HKQ0603W/HKQ0603C/HKQ0603S/ HKQ0603U		
	AQ105		
	MCFE1608		
	MCKK2012		
	Test Methods and Remarks	BK0402Series, BKP0402Series Measuring frequency : 100±1MHz Measuring equipment : E4991A (or its equivalent) Measuring jig : 16197A (or its equivalent)	
		BK0603Series, BKP0603Series Measuring frequency : 100±1MHz Measuring equipment : 4291A (or its equivalent) Measuring jig : 16193A (or its equivalent)	
		BK1005Series, BKP1005Series, BKH1005Series Measuring frequency : 100±1MHz Measuring equipment : 4291A (or its equivalent) Measuring jig : 16192A (or its equivalent), 16193A (or its equivalent)	
		BK1608・2125Series, BKP1608・2125Series Measuring frequency : 100±1MHz Measuring equipment : 4291A (or its equivalent), 4195A (or its equivalent) Measuring jig : 16092A (or its equivalent) or 16192A (or its equivalent) /HW	
		BK2010・3216Series, MCF Series Measuring frequency : 100±1MHz Measuring equipment : 4291A (or its equivalent), 4195A (or its equivalent) Measuring jig : 16192A (or its equivalent)	

▶ This catalog contains the typical specification only due to the limitation of space. When you consider the purchase of our products, please check our specification. For details of each product (characteristics graph, reliability information, precautions for use, and so on), see our Web site (<http://www.ty-top.com/>).

5. Inductance

Specified Value	BK0402		
	BK0603		
	BK1005		
	BKH0603		
	BKH1005		
	BK1608		
	BK2125		
	ARRAY	BK2010	
		BK3216	
	BKP0402		
	BKP0603		
	BKP1005		
	BKP1608		
	BKP2125		
	MCF 0605		
	MCF 0806		
	MCF 1210		
	MCF 2010		
	CK1608	4.7~10.0 μ H: \pm 20%	
	CK2125	0.1~10.0 μ H: \pm 20%	
	CKS2125	1.0~10.0 μ H: \pm 20%	
	CKP1608	0.33~2.2 μ H: \pm 20%	
	CKP2012	0.47~4.7 μ H: \pm 20%	
	CKP2016	0.47~4.7 μ H: \pm 20%	
	CKP2520	0.47~4.7 μ H: \pm 20%	
	NM2012	0.82~1.0 μ H: \pm 20%	
	NM2520	1.0~2.2 μ H: \pm 20%	
	LK1005	0.12~2.2 μ H: \pm 10 or 20%	
	LK1608	0.047~33.0 μ H: \pm 20% 0.10~12.0 μ H: \pm 10%	
	LK2125	0.047~33.0 μ H: \pm 20% 0.10~12.0 μ H: \pm 10%	
	HK0603	1.0~6.2nH: \pm 0.3nH 6.8~100nH: \pm 5%	
	HK1005	1.0~6.2nH: \pm 0.3nH 6.8~270nH: \pm 5%	
	HK1608	1.0~5.6nH: \pm 0.3nH 6.8~470nH: \pm 5%	
	HK2125	1.5~5.6nH: \pm 0.3nH 6.8~470nH: \pm 5%	
	HKQ0402	0.5~3.9nH: \pm 0.1 or 0.2 or 0.3nH 4.3~5.6nH: \pm 0.3nH or 3% or 5% 6.2~47nH: \pm 3 or 5%	
	HKQ0603W	0.6~3.9nH: \pm 0.1 or 0.2 or 0.3nH 4.3~6.2nH: \pm 0.2 or 0.3nH or 3 or 5% 6.8~27nH: \pm 3 or 5% 33~100nH: \pm 5%	
	HKQ0603C	0.6~3.9nH: \pm 0.1 or 0.2 or 0.3nH 4.3~6.2nH: \pm 0.2 or 0.3nH 6.8~22nH: \pm 3 or 5%	
	HKQ0603S	0.6~6.2nH: \pm 0.2 or 0.3nH 6.8~22nH: \pm 3 or 5%	
	HKQ0603U	0.6~4.2nH: \pm 0.1 or 0.2 or 0.3nH 4.3~6.5nH: \pm 0.2 or 0.3nH 6.8~22nH: \pm 3 or 5%	
	AQ105	1.0~6.2nH: \pm 0.3nH 6.8~15nH: \pm 5%	
	MCFE1608	0.24~1.0 μ H: \pm 20%	
	MCKK2012	1.0 μ H: \pm 20%	
	Test Methods and Remarks	CK, LK, CKP, NM, MC Series	
		Measuring frequency	: 2~4MHz (CK1608) : 2~25MHz (CK2125) : 2~10MHz (CKS2125) : 10~25MHz (LK1005) : 1~50MHz (LK1608) : 0.4~50MHz (LK2125) : 1MHz (CKP1608·CKP2012·CKP2016·CKP2520·NM2012·NM2520·MCFE1608·MCKK2012) Measuring equipment /jig : ·4194A+16085B+16092A (or its equivalent) ·4195A+41951+16092A (or its equivalent) ·4294A+16192A (or its equivalent) ·4291A+16193A (or its equivalent)/LK1005 ·4285A+42841A+42842C+42851-61100 (or its equivalent)/CKP1608·CKP2012·CKP2016·CKP2520·NM2012·NM2520·MCFE1608·MCKK2012
	HK, HKQ, AQ Series	Measuring current	: ·1mA rms (0.047~4.7 μ H) ·0.1mA rms (5.6~33 μ H)
Measuring frequency		: 100MHz (HK0603·HK1005·AQ105)	
Measuring frequency		: 50/100MHz (HK1608·HK2125)	
Measuring frequency		: 500MHz (HKQ0603C·HKQ0603S·HKQ0603U)	
Measuring frequency		: 300/500MHz (HKQ0603W)	
Measuring frequency		: 100/500MHz (HKQ0402)	
Measuring equipment /jig		: ·4291A+16197A (or its equivalent)/HK0603·AQ105 ·4291A+16193A (or its equivalent)/HK1005 ·E4991A+16197A (or its equivalent)/HKQ0603S·HKQ0603U·HKQ0603W·HKQ0603C ·4291A+16092A + in-house made jig (or its equivalent)/HK1608·HK2125 ·E4991A+16196D (or its equivalent)/HKQ0402	

▶ This catalog contains the typical specification only due to the limitation of space. When you consider the purchase of our products, please check our specification.
For details of each product (characteristics graph, reliability information, precautions for use, and so on), see our Web site (<http://www.ty-top.com/>).

7. DC Resistance			
Specified Value	BK0402	0.07~1.2 Ω max.	
	BK0603	0.065~1.50 Ω max.	
	BK1005	0.03~0.90 Ω max.	
	BKH0603	0.26~3.20 Ω max.	
	BKH1005	0.85~2.00 Ω max.	
	BK1608	0.05~1.10 Ω max.	
	BK2125	0.05~0.75 Ω max.	
	ARRAY	BK2010	0.10~0.90 Ω max.
		BK3216	0.15~0.80 Ω max.
	BKP0402	0.05~0.15 Ω max.	
	BKP0603	0.030~0.180 Ω max.	
	BKP1005	0.0273~0.220 Ω max.	
	BKP1608	0.025~0.18 Ω max.	
	BKP2125	0.020~0.075 Ω max.	
	MCF 0605	2.5~6.5 Ω max	
	MCF 0806	2.5~5.0 Ω max.	
	MCF 1210	2.5~4.5 Ω max.	
	MCF 2010	4.5 Ω max.	
	CK1608	0.45~0.85 Ω(±30%)	
	CK2125	0.16~0.65 Ω max.	
	CKS2125	0.12~0.52 Ω max.	
	CKP1608	0.15~0.35 Ω max.	
	CKP2012	0.08~0.28 Ω max.	
	CKP2016	0.075~0.20 Ω max	
	CKP2520	0.05~0.16 Ω max.	
	NM2012	0.10~0.15 Ω max.	
	NM2520	0.11~0.22 Ω max.	
	LK1005	0.41~1.16 Ω max.	
	LK1608	0.2~2.2 Ω max.	
	LK2125	0.1~1.1 Ω max.	
	HK0603	0.11~3.74 Ω max.	
	HK1005	0.08~4.8 Ω max.	
	HK1608	0.05~2.6 Ω max.	
	HK2125	0.10~1.5 Ω max.	
	HKQ0402	0.08~5.0 Ω max.	
	HKQ0603W	0.07~4.1 Ω max.	
	HKQ0603C	0.07~1.6 Ω max.	
	HKQ0603S	0.06~1.29 Ω max.	
	HKQ0603U	0.06~1.29 Ω max.	
	AQ105	0.07~0.45 Ω max.	
MCFE1608	0.100~0.340 Ω max.		
MCKK2012	0.123 Ω max.		
Test Methods and Remarks	Measuring equipment: VOAC-7412, VOAC-7512, VOAC-7521 (made by Iwasaki Tsushinki), HIOKI3227 (or its equivalent)		

8. Self Resonance Frequency (SRF)				
Specified Value	BK0402	—		
	BK0603			
	BK1005			
	BKH0603			
	BKH1005			
	BK1608			
	BK2125			
	ARRAY		BK2010	
			BK3216	
	BKP0402			
	BKP0603			
	BKP1005			
	BKP1608			
	BKP2125			
	MCF 0605			
	MCF 0806			
	MCF 1210			
	MCF 2010			
	CK1608		17~25MHz min.	
	CK2125		24~235MHz min.	
	CKS2125		24~75MHz min.	
	CKP1608		—	
	CKP2012			
	CKP2016			
	CKP2520			
	NM2012			
	NM2520			
	LK1005			40~180MHz min.
	LK1608			9~260MHz min.
	LK2125		13~320MHz min.	
	HK0603		900~10000MHz min.	
	HK1005		400~10000MHz min.	
	HK1608		300~10000MHz min.	
	HK2125		200~4000MHz min.	
	HKQ0402		1200~10000MHz min.	
	HKQ0603W		800~10000MHz min.	
	HKQ0603C		2500~10000MHz min.	
	HKQ0603S		1900~10000MHz min.	
	HKQ0603U		1900~10000MHz min.	
	AQ105		2300~10000MHz min.	
MCFE1608	—			
MCKK2012				
Test Methods and Remarks	LK, CK Series : Measuring equipment : 4195A (or its equivalent) Measuring jig : 41951 + 16092A (or its equivalent) HK, HKQ, AQ Series : Measuring equipment : 8719C (or its equivalent) • 8753D (or its equivalent) / HK2125			

▶ This catalog contains the typical specification only due to the limitation of space. When you consider the purchase of our products, please check our specification. For details of each product (characteristics graph, reliability information, precautions for use, and so on), see our Web site (<http://www.ty-top.com/>).

9. Temperature Characteristic

Specified Value	BK0402	-	
	BK0603		
	BK1005		
	BKH0603		
	BKH1005		
	BK1608		
	BK2125		
	ARRAY		BK2010
			BK3216
	BKP0402		
	BKP0603		
	BKP1005		
	BKP1608		
	BKP2125		
	MCF 0605		
	MCF 0806		
	MCF 1210		
	MCF 2010		
	CK1608		
	CK2125		
	CKS2125		
	CKP1608		
	CKP2012		
	CKP2016		
	CKP2520		
	NM2012		
	NM2520		
	LK1005		
	LK1608		
	LK2125		
	HK0603		Inductance change: Within $\pm 10\%$
	HK1005		
HK1608			
HK2125			
HKQ0402			
HKQ0603W			
HKQ0603C			
HKQ0603S			
HKQ0603U			
AQ105			
MCFE1608			
MCKK2012			
Test Methods and Remarks	HK, HKQ, AQ Series: Temperature range : $-30 \sim +85^{\circ}\text{C}$ Reference temperature : $+20^{\circ}\text{C}$		
	MC Series: Temperature range : $-40 \sim +85^{\circ}\text{C}$ Reference temperature : $+20^{\circ}\text{C}$		

10. Resistance to Flexure of Substrate

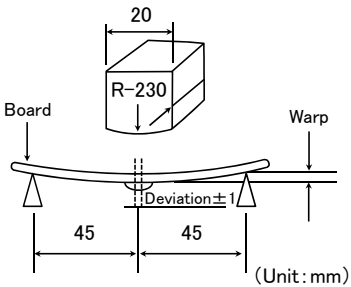
Specified Value	BK0402	No mechanical damage.	
	BK0603		
	BK1005		
	BKH0603		
	BKH1005		
	BK1608		
	BK2125		
	ARRAY		BK2010
			BK3216
	BKP0402		
	BKP0603		
	BKP1005		
	BKP1608		
	BKP2125		
	MCF 0605		
	MCF 0806		
	MCF 1210		
	MCF 2010		
	CK1608		
	CK2125		
	CKS2125		
	CKP1608		
	CKP2012		
	CKP2016		
	CKP2520		
	NM2012		
	NM2520		
	LK1005		
	LK1608		
	LK2125		
	HK0603		
	HK1005		
HK1608			
HK2125			
HKQ0402			
HKQ0603W			
HKQ0603C			
HKQ0603S			
HKQ0603U			
AQ105			
MCFE1608			
MCKK2012			
Test Methods and Remarks	<p>Warp : 2mm (BK Series without 0402size, BKP, BKH1005, CK, CKS, CKP, NM, LK, HK, HKQ0603S, HKQ0603U, AQ Series, MCF1210, MC Series)</p> <p>Testing board : 1mm (BK0402, BKP0402, BKH0603, HKQ0402, HKQ0603W, HKQ0603C Series, MCF Series without 1210 size,)</p> <p>Thickness : glass epoxy-resin substrate</p> <p> : 0.8mm</p>		

► This catalog contains the typical specification only due to the limitation of space. When you consider the purchase of our products, please check our specification. For details of each product (characteristics graph, reliability information, precautions for use, and so on), see our Web site (<http://www.ty-top.com/>).

11. Solderability

Specified Value	BK0402	At least 75% of terminal electrode is covered by new solder.	
	BK0603		
	BK1005		
	BKH0603		
	BKH1005		
	BK1608		
	BK2125		
	ARRAY		BK2010
			BK3216
	BKP0402		
	BKP0603		
	BKP1005		
	BKP1608		
	BKP2125		
	MCF 0605		
	MCF 0806		
	MCF 1210		
	MCF 2010		
	CK1608		At least 75% of terminal electrode is covered by new solder.
	CK2125		
	CKS2125		
	CKP1608		
	CKP2012		
	CKP2016		
	CKP2520		
NM2012			
NM2520			
LK1005			
LK1608			
LK2125			
HK0603			
HK1005			
HK1608			
HK2125			
HKQ0402			
HKQ0603W			
HKQ0603C			
HKQ0603S			
HKQ0603U			
AQ105			
MCFE1608			
MCKK2012			
Test Methods and Remarks	Solder temperature : 230±5°C (JIS Z 3282 H60A or H63A)		
	Solder temperature : 245±3°C (Sn/3.0Ag/0.5Cu)		
	Duration : 4±1 sec.		

► This catalog contains the typical specification only due to the limitation of space. When you consider the purchase of our products, please check our specification.
 For details of each product (characteristics graph, reliability information, precautions for use, and so on), see our Web site (<http://www.ty-top.com/>).

12. Resistance to Soldering			
Specified Value	BK0402	Appearance: No significant abnormality Impedance change: Within $\pm 30\%$	
	BK0603		
	BK1005		
	BKH0603		
	BKH1005		
	BK1608		
	BK2125		
	ARRAY		BK2010
			BK3216
	BKP0402		
	BKP0603		
	BKP1005		
	BKP1608		
	BKP2125		
	MCF 0605		Appearance: No significant abnormality Impedance change: Within $\pm 20\%$
	MCF 0806		
	MCF 1210		
	MCF 2010		
	CK1608		
	CK2125	No mechanical damage. Remaining terminal electrode: 70% min	
	CKS2125		
	CKP1608	Inductance change R10~4R7: Within $\pm 10\%$ 6R8~100: Within $\pm 15\%$ CKS2125 : Within $\pm 20\%$ CKP1608、CKP2012、CKP2016、CKP2520、NM2012、NM2520: Within $\pm 30\%$	
	CKP2012		
	CKP2016		
	CKP2520		
NM2012			
NM2520			
LK1005	No mechanical damage. Remaining terminal electrode: 70% min. Inductance change: Within $\pm 15\%$		
LK1608			
LK2125	No mechanical damage. Remaining terminal electrode: 70% min. Inductance change 47N~4R7: Within $\pm 10\%$ 5R6~330: Within $\pm 15\%$		
HK0603			
HK1005			
HK1608	No mechanical damage. Remaining terminal electrode: 70% min. Inductance change: Within $\pm 5\%$		
HK2125			
HKQ0402			
HKQ0603W			
HKQ0603C			
HKQ0603S			
HKQ0603U			
AQ105			
MCFE1608		No mechanical damage. Remaining terminal electrode: 70% min. Inductance change: Within $\pm 10\%$	
MCKK2012			
Test Methods and Remarks	Solder temperature : $260 \pm 5^\circ\text{C}$ Duration : 10 ± 0.5 sec. Preheating temperature : 150 to 180°C Preheating time : 3 min. Flux : Immersion into methanol solution with colophony for 3 to 5 sec. Recovery : 2 to 3 hrs of recovery under the standard condition after the test. (See Note 1)		
(Note 1) When there are questions concerning measurement result; measurement shall be made after 48 ± 2 hrs of recovery under the standard condition.			

13. Thermal Shock

Specified Value	BK0402	Appearance: No significant abnormality Impedance change: Within $\pm 30\%$		
	BK0603			
	BK1005			
	BKH0603			
	BKH1005			
	BK1608			
	BK2125			
	ARRAY		BK2010	
			BK3216	
	BKP0402			
	BKP0603			
	BKP1005			
	BKP1608			
	BKP2125			
	MCF 0605		Appearance: No significant abnormality Impedance change: Within $\pm 20\%$	
	MCF 0806			
	MCF 1210			
	MCF 2010			
	CK1608	No mechanical damage.		
	CK2125	Inductance change: Within $\pm 20\%$ Q change: Within $\pm 30\%$		
	CKS2125	Inductance change: Within $\pm 20\%$ (CKS2125)		
	CKP1608	No mechanical damage. Inductance change: Within $\pm 30\%$		
	CKP2012			
	CKP2016			
	CKP2520			
	NM2012			
	NM2520	No mechanical damage. Inductance change: Within $\pm 10\%$ Q change: Within $\pm 30\%$		
	LK1005			
	LK1608			
	LK2125	No mechanical damage. Inductance change: Within $\pm 10\%$ Q change: Within $\pm 20\%$		
	HK0603			
	HK1005			
	HK1608			
	HK2125			
	HKQ0402			
	HKQ0603W			
	HKQ0603C			
	HKQ0603S			
	HKQ0603U			
	AQ105	Appearance: No significant abnormality Inductance change: Within $\pm 10\%$		
	MCFE1608			
	MCKK2012			
	Test Methods and Remarks	Conditions for 1 cycle		
		Step	temperature (°C)	time (min.)
		1	Minimum operating temperature +0/−3	30±3
2		Room temperature	2~3	
3		Maximum operating temperature +3/−0	30±3	
4		Room temperature	2~3	
Number of cycles :5				
Recovery: 2 to 3 hrs of recovery under the standard condition after the test. (See Note 1)				

(Note 1) When there are questions concerning measurement result; measurement shall be made after 48±2 hrs of recovery under the standard condition.

14. Damp Heat (Steady state)			
Specified Value	BK0402	Appearance: No significant abnormality Impedance change: Within $\pm 30\%$	
	BK0603		
	BK1005		
	BKH0603		
	BKH1005		
	BK1608		
	BK2125		
	ARRAY		BK2010
			BK3216
	BKP0402		
	BKP0603		
	BKP1005		
	BKP1608		
	BKP2125		
	MCF 0605		Appearance: No significant abnormality Impedance change: Within $\pm 20\%$
	MCF 0806		
	MCF 1210		
	MCF 2010		
	CK1608	No mechanical damage.	
	CK2125	Inductance change: Within $\pm 20\%$ Q change: Within $\pm 30\%$	
	CKS2125	Inductance change: Within $\pm 20\%$	
	CKP1608	No mechanical damage. Inductance change: Within $\pm 30\%$	
	CKP2012		
	CKP2016		
	CKP2520		
	NM2012		
	NM2520		
	LK1005	No mechanical damage.	
	LK1608	Inductance change: Within $\pm 10\%$ Q change: Within $\pm 30\%$	
	LK2125	No mechanical damage. Inductance change: Within $\pm 20\%$ Q change: Within $\pm 30\%$	
	HK0603	No mechanical damage. Inductance change: Within $\pm 10\%$ Q change: Within $\pm 20\%$	
	HK1005		
	HK1608		
HK2125			
HKQ0402			
HKQ0603W			
HKQ0603C			
HKQ0603S			
HKQ0603U			
AQ105			
MC1608	Appearance: No significant abnormality Inductance change: Within $\pm 10\%$		
MC2012			
Test Methods and Remarks	BK, BKP, BKH Series, MCF Series: Temperature : $40 \pm 2^\circ\text{C}$ Humidity : 90 to 95%RH Duration : 500+24/-0 hrs Recovery : 2 to 3 hrs of recovery under the standard condition after the removal from test chamber. (See Note 1)		
	LK, CK, CKS, CKP, NM, HK, HKQ, AQ, MC Series: Temperature : $40 \pm 2^\circ\text{C}$ (LK, CK, CKS, CKP, NM Series) : $60 \pm 2^\circ\text{C}$ (HK, HKQ, AQ, MC Series) Humidity : 90 to 95%RH Duration : 500±12 hrs Recovery : 2 to 3 hrs of recovery under the standard condition after the removal from test chamber. (See Note 1)		
(Note 1) When there are questions concerning measurement result; measurement shall be made after 48 ± 2 hrs of recovery under the standard condition.			

15. Loading under Damp Heat

Specified Value	BK0402	Appearance: No significant abnormality Impedance change: Within $\pm 30\%$	
	BK0603		
	BK1005		
	BKH0603		
	BKH1005		
	BK1608		
	BK2125		
	ARRAY		BK2010
			BK3216
	BKP0402		
	BKP0603		
	BKP1005		
	BKP1608		
	BKP2125		
	CK1608	No mechanical damage.	
	CK2125	Inductance change: Within $\pm 20\%$ Q change: Within $\pm 30\%$	
	CKS2125	No mechanical damage. Inductance change: Within $\pm 20\%$	
	CKP1608	No mechanical damage. Inductance change: Within $\pm 30\%$	
	CKP2012		
	CKP2016		
	CKP2520		
	NM2012		
	NM2520		
	LK1005	No mechanical damage. Inductance change: Within $\pm 10\%$ Q change: Within $\pm 30\%$	
	LK1608	No mechanical damage. Inductance change: 0.047~12.0 μH : Within $\pm 10\%$ 15.0~33.0 μH : Within $\pm 15\%$ Q change: Within $\pm 30\%$	
	LK2125	No mechanical damage. Inductance change: Within $\pm 20\%$ Q change: Within $\pm 30\%$	
	HK0603	No mechanical damage. Inductance change: Within $\pm 10\%$ Q change: Within $\pm 20\%$	
HK1005			
HK1608			
HK2125			
HKQ0402			
HKQ0603W			
HKQ0603C			
HKQ0603S			
HKQ0603U			
AQ105			
MCFE1608			
MCKK2012	Appearance: No significant abnormality Inductance change: Within $\pm 10\%$		
Test Methods and Remarks	BK, BKP, BKH Series: Temperature : $40 \pm 2^\circ\text{C}$ Humidity : 90 to 95%RH Applied current : Rated current Duration : $500 + 24 / - 0$ hrs Recovery : 2 to 3 hrs of recovery under the standard condition after the removal from test chamber. (See Note 1) LK, CK, CKS, CKP, NK, HK, HKQ, AQ, MC Series: Temperature : $40 \pm 2^\circ\text{C}$ (LK, CK, CKS, CKP, NM Series) : $60 \pm 2^\circ\text{C}$ (HK, HKQ, AQ, MC Series) Humidity : 90 to 95%RH Applied current : Rated current Duration : 500 ± 12 hrs Recovery : 2 to 3 hrs of recovery under the standard condition after the removal from test chamber. (See Note 1)		

Note on standard condition: "standard condition" referred to herein is defined as follows:

5 to 35°C of temperature, 45 to 85% relative humidity, and 86 to 106kPa of air pressure.

When there are questions concerning measurement results:

In order to provide correlation data, the test shall be conducted under condition of $20 \pm 2^\circ\text{C}$ of temperature, 60 to 70% relative humidity, and 86 to 106kPa of air pressure.

Unless otherwise specified, all the tests are conducted under the "standard condition."

(Note 1) Measurement shall be made after 48 ± 2 hrs of recovery under the standard condition.

16. Loading at High Temperature

Specified Value	BK0402	Appearance: No significant abnormality Impedance change: Within $\pm 30\%$	
	BK0603		
	BK1005		
	BKH0603		
	BKH1005		
	BK1608		
	BK2125		
	ARRAY		BK2010
			BK3216
	BKP0402		
	BKP0603		
	BKP1005		
	BKP1608		
	BKP2125		
	MCF 0605		Appearance: No significant abnormality Impedance change: Within $\pm 20\%$
	MCF 0806		
	MCF 1210		
	MCF 2010		
	CK1608	No mechanical damage.	
	CK2125	Inductance change: Within $\pm 20\%$ Q change: Within $\pm 30\%$	
	CKS2125	No mechanical damage. Inductance change: Within $\pm 20\%$	
	CKP1608	No mechanical damage. Inductance change: Within $\pm 30\%$	
	CKP2012		
	CKP2016		
	CKP2520		
	NM2012		
	NM2520		
	LK1005	No mechanical damage. Inductance change: Within $\pm 10\%$ Q change: Within $\pm 30\%$	
	LK1608	No mechanical damage. Inductance change: 0.047~12.0 μH : Within $\pm 10\%$ 15.0~33.0 μH : Within $\pm 15\%$ Q change: Within $\pm 30\%$	
	LK2125	No mechanical damage. Inductance change: Within $\pm 20\%$ Q change: Within $\pm 30\%$	
	HK0603	No mechanical damage. Inductance change: Within $\pm 10\%$ Q change: Within $\pm 20\%$	
	HK1005		
HK1608			
HK2125			
HKQ0402			
HKQ0603W			
HKQ0603C			
HKQ0603S			
HKQ0603U			
AQ105			
MCFE1608	Appearance: No significant abnormality Inductance change: Within $\pm 10\%$		
MCKK2012			
Test Methods and Remarks	<p>BK, BKH, BKP Series, MCF Series: Temperature : 125\pm3$^{\circ}$C (BK, BKH Series) : 85\pm3$^{\circ}$C (BKP, MCF Series) Applied current : Rated current Duration : 500+24/-0 hrs Recovery : 2 to 3 hrs of recovery under the standard condition after the removal from test chamber. (See Note 1)</p> <p>LK, CK, CKS, CKP, NM, HK, HKQ, AQ, MC Series: Temperature : 85\pm2$^{\circ}$C (LK, CK, CKS, CKP, NM, MC Series) : 85\pm2$^{\circ}$C (HK1608, 2125) : 85\pm2$^{\circ}$C (HK1005, AQ105 operating temperature range -55~+85$^{\circ}$C) : 125\pm2$^{\circ}$C (HKQ0402, HK0603, HK1005, HKQ0603S, HKQ0603U, HKQ0603W, HKQ0603C, AQ105 operating temperature range -55~+125$^{\circ}$C) Applied current : Rated current Duration : 500\pm12 hrs Recovery : 2 to 3 hrs of recovery under the standard condition after the test. (See Note 1)</p>		

Note on standard condition: "standard condition" referred to herein is defined as follows:

5 to 35 $^{\circ}$ C of temperature, 45 to 85% relative humidity, and 86 to 106kPa of air pressure.

When there are questions concerning measurement results:

In order to provide correlation data, the test shall be conducted under condition of 20 \pm 2 $^{\circ}$ C of temperature, 60 to 70% relative humidity, and 86 to 106kPa of air pressure. Unless otherwise specified, all the tests are conducted under the "standard condition."

(Note 1) Measurement shall be made after 48 \pm 2 hrs of recovery under the standard condition.

Precautions on the use of Multilayer chip inductors

Multilayer chip inductors for high frequency, Multilayer chip bead inductors

Multilayer common mode choke coils (MC series F type)

Metal Multilayer Chip Power Inductors (MCOIL™ MC series)

■ PRECAUTIONS

1. Circuit Design

Precautions	<ul style="list-style-type: none"> ◆ Verification of operating environment, electrical rating and performance <ol style="list-style-type: none"> 1. A malfunction in medical equipment, spacecraft, nuclear reactors, etc. may cause serious harm to human life or have severe social ramifications. <p>As such, any inductors to be used in such equipment may require higher safety and/or reliability considerations and should be clearly differentiated from components used in general purpose applications.</p> ◆ Operating Current (Verification of Rated current) <ol style="list-style-type: none"> 1. The operating current for inductors must always be lower than their rated values. 2. Do not apply current in excess of the rated value because the inductance may be reduced due to the magnetic saturation effect.
-------------	---

2. PCB Design

Precautions	<ul style="list-style-type: none"> ◆ Pattern configurations (Design of Land-patterns) <ol style="list-style-type: none"> 1. When inductors are mounted on a PCB, the size of land patterns and the amount of solder used (size of fillet) can directly affect inductor performance. <p>Therefore, the following items must be carefully considered in the design of solder land patterns:</p> <ol style="list-style-type: none"> (1) The amount of solder applied can affect the ability of chips to withstand mechanical stresses which may lead to breaking or cracking. Therefore, when designing land-patterns it is necessary to consider the appropriate size and configuration of the solder pads which in turn determines the amount of solder necessary to form the fillets. (2) When more than one part is jointly soldered onto the same land or pad, the pad must be designed so that each component's soldering point is separated by solder-resist. (3) The larger size of land patterns and amount of solder, the smaller Q value after mounting on PCB. It makes higher the Q value to design land patterns smaller than terminal electrode of chips. ◆ Pattern configurations (Inductor layout on panelized [breakaway] PC boards) <ol style="list-style-type: none"> 1. After inductors have been mounted on the boards, chips can be subjected to mechanical stresses in subsequent manufacturing processes (PCB cutting, board inspection, mounting of additional parts, assembly into the chassis, wave soldering the reflow soldered boards etc.) For this reason, planning pattern configurations and the position of SMD inductors should be carefully performed to minimize stress.
-------------	---

Technical considerations	<ul style="list-style-type: none"> ◆ Pattern configurations (Design of Land-patterns) <ol style="list-style-type: none"> 1. The following diagrams and tables show some examples of recommended patterns to prevent excessive solder amounts (larger fillets which extend above the component end terminations). Examples of improper pattern designs are also shown. (1) Recommended land dimensions for a typical chip inductor land patterns for PCBs
--------------------------	--

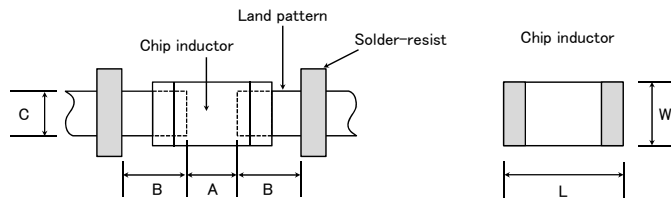

Recommended land dimensions for wave-soldering (Unit: mm)

Type	1608	2012	2125	2016	2520	3216	
Size	L	1.6	2.0	2.0	2.0	2.5	3.2
	W	0.8	1.25	1.25	1.6	2.0	1.6
A	0.8~1.0	1.0~1.4	1.0~1.4	1.0~1.4	1.0~1.4	1.8~2.5	
B	0.5~0.8	0.8~1.5	0.8~1.5	0.8~1.5	0.6~1.0	0.8~1.7	
C	0.6~0.8	0.9~1.2	0.9~1.2	1.3~1.6	1.6~2.0	1.2~1.6	

Recommended land dimensions for reflow-soldering (Unit: mm)

Type	0402	0603	1005	105	1608	2012	2125	2016	2520	3216
Size	L	0.4	0.6	1.0	1.0	1.6	2.0	2.0	2.5	3.2
	W	0.2	0.3	0.5	0.6	0.8	1.25	1.25	1.6	2.0
A	0.15~0.25	0.20~0.30	0.45~0.55	0.50~0.55	0.8~1.0	0.8~1.2	0.8~1.2	0.8~1.2	1.0~1.4	1.8~2.5
B	0.10~0.20	0.20~0.30	0.40~0.50	0.30~0.40	0.6~0.8	0.8~1.2	0.8~1.2	0.8~1.2	0.6~1.0	0.6~1.5
C	0.15~0.30	0.25~0.40	0.45~0.55	0.60~0.70	0.6~0.8	0.9~1.6	0.9~1.6	1.2~2.0	1.8~2.2	1.2~2.0

▶ This catalog contains the typical specification only due to the limitation of space. When you consider the purchase of our products, please check our specification. For details of each product (characteristics graph, reliability information, precautions for use, and so on), see our Web site (<http://www.ty-top.com/>).

Excess solder can affect the ability of chips to withstand mechanical stresses. Therefore, please take proper precautions when designing land-patterns.

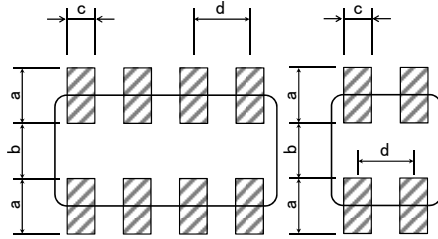

Recommended land dimension for Reflow-soldering

Type	3216	2010	1210	0806	0605	
Size	L	3.2	2.0	1.25	0.85	0.65
	W	1.6	1.0	1.0	0.65	0.50
a	0.7~0.9	0.5~0.6	0.45~0.55	0.25~0.35	0.27~0.33	
b	0.8~1.0	0.5~0.6	0.7~0.8	0.25~0.35	0.17~0.23	
c	0.4~0.5	0.2~0.3	0.25~0.35	0.25~0.35	0.20~0.26	
d	0.8	0.5	0.55	0.5	0.4	

(Unit: mm)

(2) Examples of good and bad solder application

Item	Not recommended	Recommended
Mixed mounting of SMD and leaded components	Lead wire of component	Solder-resist
Component placement close to the chassis	Chassis Solder (for grounding) Electrode pattern	Solder-resist
Hand-soldering of leaded components near mounted components	Lead wire of component Soldering iron	Solder-resist
Horizontal component placement		Solder-resist

◆ Pattern configurations (Inductor layout on panelized [breakaway] PC boards)

1-1. The following are examples of good and bad inductor layout; SMD inductors should be located to minimize any possible mechanical stresses from board warp or deflection.

Item	Not recommended	Recommended
Deflection of the board		Position the component at a right angle to the direction of the mechanical stresses that are anticipated.

1-2. To layout the inductors for the breakaway PC board, it should be noted that the amount of mechanical stresses given will vary depending on inductor layout.

An example below should be counted for better design.

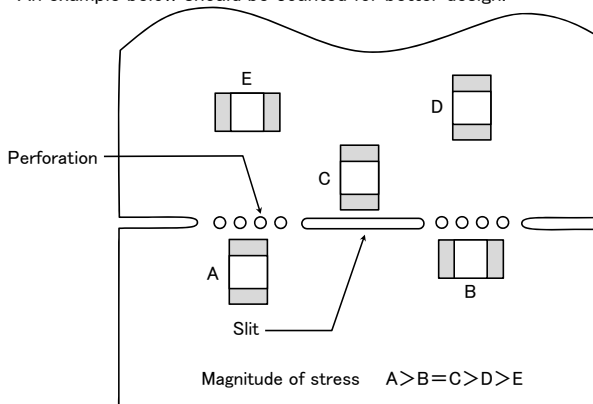

1-3. When breaking PC boards along their perforations, the amount of mechanical stress on the inductors can vary according to the method used. The following methods are listed in order from least stressful to most stressful: push-back, slit, V-grooving, and perforation. Thus, any ideal SMD inductor layout must also consider the PCB splitting procedure.

3. Considerations for automatic placement

Precautions

- ◆ Adjustment of mounting machine
 1. Excessive impact load should not be imposed on the inductors when mounting onto the PC boards.
 2. The maintenance and inspection of the mounter should be conducted periodically.
- ◆ Selection of Adhesives
 1. Mounting inductors with adhesives in preliminary assembly, before the soldering stage, may lead to degraded inductor characteristics unless the following factors are appropriately checked; the size of land patterns, type of adhesive, amount applied, hardening temperature and hardening period. Therefore, it is imperative to consult the manufacturer of the adhesives on proper usage and amounts of adhesive to use.

Technical considerations

- ◆ Adjustment of mounting machine
 1. If the lower limit of the pick-up nozzle is low, too much force may be imposed on the inductors, causing damage. To avoid this, the following points should be considered before lowering the pick-up nozzle:
 - (1) The lower limit of the pick-up nozzle should be adjusted to the surface level of the PC board after correcting for deflection of the board.
 - (2) The pick-up pressure should be adjusted between 1 and 3N static loads.
 - (3) To reduce the amount of deflection of the board caused by impact of the pick-up nozzle, supporting pins or back-up pins should be used under the PC board. The following diagrams show some typical examples of good pick-up nozzle placement:

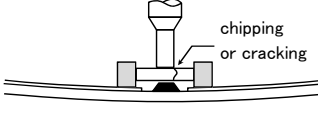
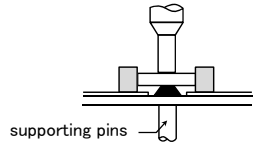
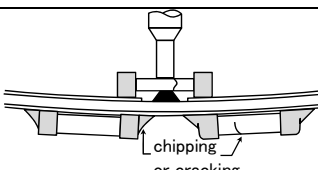
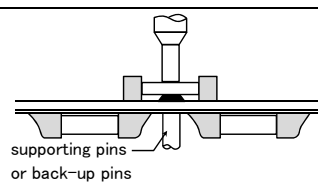
Item	Improper method	Proper method
Single-sided mounting		
Double-sided mounting		

2. As the alignment pin wears out, adjustment of the nozzle height can cause chipping or cracking of the inductors because of mechanical impact on the inductors. To avoid this, the monitoring of the width between the alignment pin in the stopped position, and maintenance, inspection and replacement of the pin should be conducted periodically.

- ◆ Selection of Adhesives
 1. Some adhesives may cause reduced insulation resistance. The difference between the shrinkage percentage of the adhesive and that of the inductors may result in stresses on the inductors and lead to cracking. Moreover, too little or too much adhesive applied to the board may adversely affect component placement, so the following precautions should be noted in the application of adhesives.
 - (1) Required adhesive characteristics
 - a. The adhesive should be strong enough to hold parts on the board during the mounting & solder process.
 - b. The adhesive should have sufficient strength at high temperatures.
 - c. The adhesive should have good coating and thickness consistency.
 - d. The adhesive should be used during its prescribed shelf life.
 - e. The adhesive should harden rapidly.
 - f. The adhesive must not be contaminated.
 - g. The adhesive should have excellent insulation characteristics.
 - h. The adhesive should not be toxic and have no emission of toxic gasses.
 - (2) When using adhesives to mount inductors on a PCB, inappropriate amounts of adhesive on the board may adversely affect component placement. Too little adhesive may cause the inductors to fall off the board during the solder process. Too much adhesive may cause defective soldering due excessive flow of adhesive on to the land or solder pad.

[Recommended conditions]

Figure	0805 case sizes as examples
a	0.3mm min
b	100~120 μm
c	Area with no adhesive

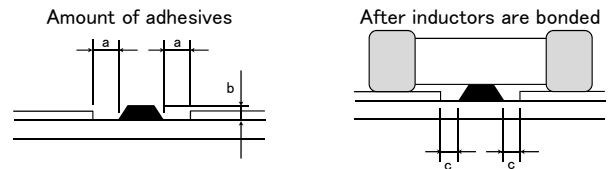

4. Soldering

Precautions

- ◆ Selection of Flux
 1. Since flux may have a significant effect on the performance of inductors, it is necessary to verify the following conditions prior to use;
 - (1) Flux used should be with less than or equal to 0.1 wt% (Chlorine conversion method) of halogenated content. Flux having a strong acidity content should not be applied.
 - (2) When soldering inductors on the board, the amount of flux applied should be controlled at the optimum level.
 - (3) When using water-soluble flux, special care should be taken to properly clean the boards.
- ◆ Soldering
 1. Temperature, time, amount of solder, etc. are specified in accordance with the following recommended conditions, and please contact us about peak temperature when you use lead-free paste.

◆ Selection of Flux

- 1-1. When too much halogenated substance (Chlorine, etc.) content is used to activate the flux, or highly acidic flux is used, an excessive amount of residue after soldering may lead to corrosion of the terminal electrodes or degradation of insulation resistance on the surface of the Inductor.
- 1-2. Flux is used to increase solderability in flow soldering, but if too much is applied, a large amount of flux gas may be emitted and may detrimentally affect solderability. To minimize the amount of flux applied, it is recommended to use a flux-bubbling system.
- 1-3. Since the residue of water-soluble flux is easily dissolved by water content in the air, the residue on the surface of Inductor in high humidity conditions may cause a degradation of insulation resistance and therefore affect the reliability of the components. The cleaning methods and the capability of the machines used should also be considered carefully when selecting water-soluble flux.

◆ Soldering

1-1. Preheating when soldering

Heating: Chip inductor components should be preheated to within 100 to 130°C of the soldering. Cooling: The temperature difference between the components and cleaning process should not be greater than 100°C.

Chip inductors are susceptible to thermal shock when exposed to rapid or concentrated heating or rapid cooling. Therefore, the soldering process must be conducted with a great care so as to prevent malfunction of the components due to excessive thermal shock.

[Reflow soldering]

【Recommended conditions for eutectic soldering】

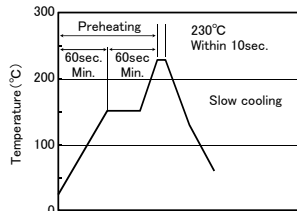

【Recommended condition for Pb-free soldering】

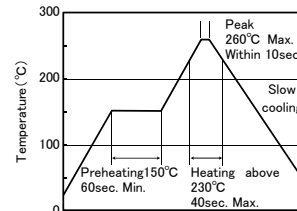

※Ceramic chip components should be preheated to within 100 to 130°C of the soldering.

※Assured to be reflow soldering for 2 times.

Caution

1. The ideal condition is to have solder mass (fillet) controlled to 1/2 to 1/3 of the thickness of the inductor, as shown below:

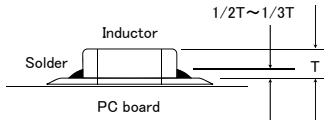

2. Because excessive dwell times can detrimentally affect solderability, soldering duration should be kept as close to recommended times as possible.

[Wave soldering]

【Recommended conditions for eutectic soldering】

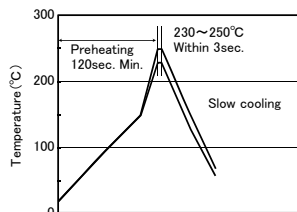

【Recommended condition for Pb-free soldering】

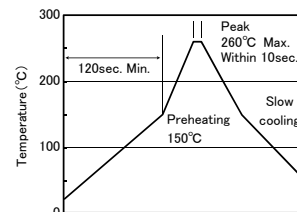

※Ceramic chip components should be preheated to within 100 to 130°C of the soldering.

※Assured to be wave soldering for 1 time.

※Except for reflow soldering type.

Caution

1. Make sure the inductors are preheated sufficiently.
2. The temperature difference between the inductor and melted solder should not be greater than 100 to 130°C.
3. Cooling after soldering should be as gradual as possible.
4. Wave soldering must not be applied to the inductors designated as for reflow soldering only.

[Hand soldering]

【Recommended conditions for eutectic soldering】

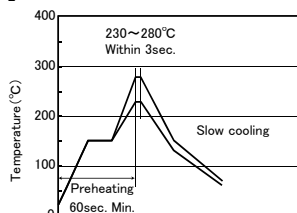

【Recommended condition for Pb-free soldering】

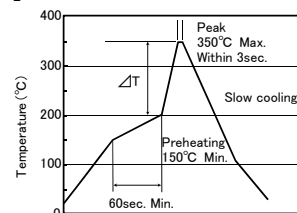

(※ΔT ≤ 190°C (3216 Type max), ΔT ≤ 130°C (3225 Type min))

※It is recommended to use 20W soldering iron and the tip is 1 φ or less.

※The soldering iron should not directly touch the components.

※Assured to be soldering iron for 1 time.

Note: The above profiles are the maximum allowable soldering condition, therefore these profiles are not always recommended.

Technical considerations

	<p>Caution</p> <ol style="list-style-type: none"> 1. Use a 20W soldering iron with a maximum tip diameter of 1.0 mm. 2. The soldering iron should not directly touch the inductor.
--	--

5. Cleaning

Precautions	<p>◆Cleaning conditions</p> <ol style="list-style-type: none"> 1. When cleaning the PC board after the Inductors are all mounted, select the appropriate cleaning solution according to the type of flux used and purpose of the cleaning (e.g. to remove soldering flux or other materials from the production process.) 2. Cleaning conditions should be determined after verifying, through a test run, that the cleaning process does not affect the inductor's characteristics. 						
Technical considerations	<p>◆Cleaning conditions</p> <ol style="list-style-type: none"> 1. The use of inappropriate solutions can cause foreign substances such as flux residue to adhere to the inductor, resulting in a degradation of the inductor's electrical properties (especially insulation resistance). 2. Inappropriate cleaning conditions (insufficient or excessive cleaning) may detrimentally affect the performance of the inductors. <ol style="list-style-type: none"> (1) Excessive cleaning <ol style="list-style-type: none"> a. In the case of ultrasonic cleaning, too much power output can cause excessive vibration of the PC board which may lead to the cracking of the inductor or the soldered portion, or decrease the terminal electrodes' strength. Thus the following conditions should be carefully checked; <table border="0" style="margin-left: 40px;"> <tr> <td>Ultrasonic output</td> <td>Below 20W/l</td> </tr> <tr> <td>Ultrasonic frequency</td> <td>Below 40kHz</td> </tr> <tr> <td>Ultrasonic washing period</td> <td>5 min. or less</td> </tr> </table> 	Ultrasonic output	Below 20W/l	Ultrasonic frequency	Below 40kHz	Ultrasonic washing period	5 min. or less
Ultrasonic output	Below 20W/l						
Ultrasonic frequency	Below 40kHz						
Ultrasonic washing period	5 min. or less						

6. Post cleaning processes

Precautions	<p>◆Application of resin coatings, moldings, etc. to the PCB and components.</p> <ol style="list-style-type: none"> 1. With some type of resins a decomposition gas or chemical reaction vapor may remain inside the resin during the hardening period or while left under normal storage conditions resulting in the deterioration of the inductor's performance. 2. When a resin's hardening temperature is higher than the inductor's operating temperature, the stresses generated by the excess heat may lead to inductor damage or destruction. 3. Stress caused by a resin's temperature generated expansion and contraction may damage inductors. <p>The use of such resins, molding materials etc. is not recommended.</p>
-------------	--

7. Handling

Precautions	<p>◆Breakaway PC boards (splitting along perforations)</p> <ol style="list-style-type: none"> 1. When splitting the PC board after mounting inductors and other components, care is required so as not to give any stresses of deflection or twisting to the board. 2. Board separation should not be done manually, but by using the appropriate devices. <p>◆General handling precautions</p> <ol style="list-style-type: none"> 1. Always wear static control bands to protect against ESD. 2. Keep the inductors away from all magnets and magnetic objects. 3. Use non-magnetic tweezers when handling inductors. 4. Any devices used with the inductors (soldering irons, measuring instruments) should be properly grounded. 5. Keep bare hands and metal products (i.e., metal desk) away from chip electrodes or conductive areas that lead to chip electrodes. 6. Keep inductors away from items that generate magnetic fields such as speakers or coils. <p>◆Mechanical considerations</p> <ol style="list-style-type: none"> 1. Be careful not to subject the inductors to excessive mechanical shocks. <ol style="list-style-type: none"> (1) If inductors are dropped on the floor or a hard surface they should not be used. (2) When handling the mounted boards, be careful that the mounted components do not come in contact with or bump against other boards or components.
-------------	---

8. Storage conditions

Precautions	<p>◆Storage</p> <ol style="list-style-type: none"> 1. To maintain the solderability of terminal electrodes and to keep the packaging material in good condition, care must be taken to control temperature and humidity in the storage area. Humidity should especially be kept as low as possible. <p style="margin-left: 40px;">Recommended conditions</p> <p style="margin-left: 40px;">Ambient temperature Below 30°C</p> <p style="margin-left: 40px;">Humidity Below 70% RH</p> <p>The ambient temperature must be kept below 40°C. Even under ideal storage conditions inductor electrode solderability decreases as time passes, so inductors should be used within 6 months from the time of delivery.</p> <p>*The packaging material should be kept where no chlorine or sulfur exists in the air.</p>
Technical considerations	<p>◆Storage</p> <ol style="list-style-type: none"> 1. If the parts are stocked in a high temperature and humidity environment, problems such as reduced solderability caused by oxidation of terminal electrodes and deterioration of taping/packaging materials may take place. For this reason, components should be used within 6 months from the time of delivery. If exceeding the above period, please check solderability before using the inductors.

▶ This catalog contains the typical specification only due to the limitation of space. When you consider the purchase of our products, please check our specification. For details of each product (characteristics graph, reliability information, precautions for use, and so on), see our Web site (<http://www.ty-top.com/>).

CHIP BEAD INDUCTORS FOR POWER LINES (FB SERIES M TYPE)



WAVE REFLOW

■ PARTS NUMBER

*Operating Temp. : -40~+125°C (Including self-generated heat)

F	B	△	M	J	3	2	1	6	H	S	8	0	0	-	T	△
①	②	③	④	⑤	⑥	⑦	⑧	⑨								

△=Blank space

① Series name

Code	Series name
FB	Ferrite bead

② Shape

Code	Shape
M	Rectangular chip

③ Characteristics

Code	Characteristics
J	Standard
H	High Impedance type

④ Dimensions (L×W)

Code	Type (inch)	Dimensions (L×W) [mm]
1608	1608(0603)	1.6×0.8
2125	2125(0805)	2.0×1.25
2012	2012(0805)	
2016	2016(0806)	2.0×1.6
3216	3216(1206)	3.2×1.6
3225	3225(1210)	3.2×2.5
4516	4516(1806)	4.5×1.6
4525	4525(1810)	4.5×2.5
4532	4532(1812)	4.5×3.2

⑤ Material

Code	Material
HS	Refer to impedance curves for material differences
HM	
HL	

⑥ Nominal impedance

Code (example)	Nominal impedance [Ω]
330	33
221	220
102	1000

⑦ Impedance tolerance

Code	Impedance tolerance
-	±25%
N	±30%

⑧ Packaging

Code	Packaging
T	Taping

⑨ Internal code

Code	Internal code
△	Standard

■ STANDARD EXTERNAL DIMENSIONS / STANDARD QUANTITY

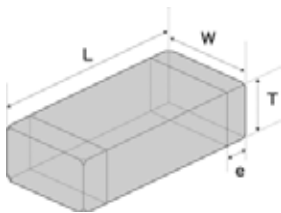

Recommended Land Patterns
Surface Mounting

• Mounting and soldering conditions should be checked beforehand.

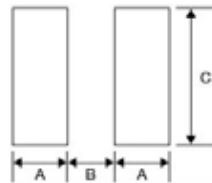

Type	A	B	C
FB MJ1608	1.0	1.0	1.0
FB MJ2125	1.4	1.2	1.65
FB MJ3216	1.4	2.2	2.0
FB MJ4516	1.75	3.5	2.0
FB MH1608	1.0	1.0	1.0
FB MH2012	1.4	1.2	1.65
FB MH2016	1.4	1.2	2.0
FB MH3216	1.4	2.2	2.0
FB MH3225	1.4	2.2	2.9
FB MH4516	1.75	3.5	2.0
FB MH4525	1.75	3.5	2.9
FB MH4532	1.75	3.5	3.7

Unit: mm

Type	L	W	T	e	Standard quantity [pcs]	
					Paper tape	Embossed tape
FB MJ1608 (0603)	1.6±0.2 (0.063±0.008)	0.8±0.2 (0.031±0.008)	0.8±0.2 (0.031±0.008)	0.3±0.2 (0.012±0.008)	4000	-
FB MJ2125 (0805)	2.0±0.2 (0.079±0.008)	1.25±0.2 (0.049±0.008)	0.85±0.2 (0.033±0.008)	0.5±0.3 (0.020±0.012)	4000	-
FB MJ3216 (1206)	3.2±0.3 (0.126±0.012)	1.6±0.2 (0.063±0.008)	1.1±0.2 (0.043±0.008)	0.5±0.3 (0.020±0.012)	-	2000
FB MJ4516 (1806)	4.5±0.3 (0.177±0.012)	1.6±0.2 (0.063±0.008)	1.1±0.2 (0.043±0.008)	0.5±0.3 (0.020±0.012)	-	2000
FB MH1608 (0603)	1.6±0.1 (0.063±0.004)	0.8±0.1 (0.031±0.004)	0.8±0.1 (0.031±0.004)	0.3±0.15 (0.012±0.006)	4000	-
FB MH2012 (0805)	2.0±0.2 (0.079±0.008)	1.25±0.2 (0.049±0.008)	0.85±0.2 (0.033±0.008)	0.5±0.3 (0.020±0.012)	4000	-
FB MH2016 (0806)	2.0±0.2 (0.079±0.008)	1.6±0.2 (0.063±0.008)	1.6±0.2 (0.063±0.008)	0.5±0.3 (0.020±0.012)	-	2000
FB MH3216 (1206)	3.2±0.3 (0.126±0.012)	1.6±0.2 (0.063±0.008)	1.6±0.2 (0.063±0.008)	0.5±0.3 (0.020±0.012)	-	2000
FB MH3225 (1210)	3.2±0.3 (0.126±0.012)	2.5±0.3 (0.098±0.012)	2.5±0.3 (0.098±0.012)	0.5±0.3 (0.020±0.012)	-	1000
FB MH4516 (1806)	4.5±0.3 (0.177±0.012)	1.6±0.2 (0.063±0.008)	1.6±0.2 (0.063±0.008)	0.5±0.3 (0.020±0.012)	-	2000
FB MH4525 (1810)	4.5±0.4 (0.177±0.016)	2.5±0.3 (0.098±0.012)	2.5±0.3 (0.098±0.012)	0.9±0.6 (0.035±0.024)	-	1000
FB MH4532 (1812)	4.5±0.4 (0.177±0.016)	3.2±0.3 (0.126±0.012)	3.2±0.3 (0.126±0.012)	0.9±0.6 (0.035±0.024)	-	2000

Unit: mm (inch)

► This catalog contains the typical specification only due to the limitation of space. When you consider the purchase of our products, please check our specification. For details of each product (characteristics graph, reliability information, precautions for use, and so on), see our Web site (<http://www.ty-top.com/>).

■ PARTS NUMBER

Standard type

● FB MJ1608

Parts number	EHS	Nominal impedance (Ω)	Impedance tolerance	Measuring frequency [MHz]	DC Resistance [Ω] (max.)	Rated current [A] (max.)	Thickness [mm]
FB MJ1608HS280NT	RoHS	28	±30%	100	0.007	4.0	0.8 ±0.2
FB MJ1608HM230NT	RoHS	23	±30%	100	0.007	4.0	0.8 ±0.2

● FB MJ2125

Parts number	EHS	Nominal impedance (Ω)	Impedance tolerance	Measuring frequency [MHz]	DC Resistance [Ω] (max.)	Rated current [A] (max.)	Thickness [mm]
FB MJ2125HS250NT	RoHS	25	±30%	100	0.004	6.0	0.85 ±0.2
FB MJ2125HS420-T	RoHS	42	±25%	100	0.008	4.0	0.85 ±0.2
FB MJ2125HM210NT	RoHS	21	±30%	100	0.004	6.0	0.85 ±0.2
FB MJ2125HM330-T	RoHS	33	±25%	100	0.008	4.0	0.85 ±0.2
FB MJ2125HL8R0NT	RoHS	8	±30%	100	0.008	4.0	0.85 ±0.2

● FB MJ3216

Parts number	EHS	Nominal impedance (Ω)	Impedance tolerance	Measuring frequency [MHz]	DC Resistance [Ω] (max.)	Rated current [A] (max.)	Thickness [mm]
FB MJ3216HS480NT	RoHS	48	±30%	100	0.005	6.0	1.1 ±0.2
FB MJ3216HS800-T	RoHS	80	±25%	100	0.010	4.0	1.1 ±0.2
FB MJ3216HM380NT	RoHS	38	±30%	100	0.005	6.0	1.1 ±0.2
FB MJ3216HM600-T	RoHS	60	±25%	100	0.010	4.0	1.1 ±0.2
FB MJ3216HL160NT	RoHS	16	±30%	100	0.012	4.0	1.1 ±0.2

● FB MJ4516

Parts number	EHS	Nominal impedance (Ω)	Impedance tolerance	Measuring frequency [MHz]	DC Resistance [Ω] (max.)	Rated current [A] (max.)	Thickness [mm]
FB MJ4516HS720NT	RoHS	72	±30%	100	0.007	6.0	1.1 ±0.2
FB MJ4516HS111-T	RoHS	110	±25%	100	0.014	4.0	1.1 ±0.2
FB MJ4516HM560NT	RoHS	56	±30%	100	0.007	6.0	1.1 ±0.2
FB MJ4516HM900-T	RoHS	90	±25%	100	0.014	4.0	1.1 ±0.2
FB MJ4516HL230NT	RoHS	23	±30%	100	0.014	3.5	1.1 ±0.2

High impedance type GHz Band

● FB MH1608

Parts number	EHS	Nominal impedance Measuring frequency 100[MHz]		Nominal impedance Measuring frequency 1 [GHz]		DC Resistance [Ω] (max.)	Rated current [A] (max.)	Thickness [mm]
		(Ω)	tolerance	(Ω)	tolerance			
FB MH1608HM470-T	RoHS	47	±25%	75	±40%	0.020	3.5	0.8 ±0.1
FB MH1608HM600-T	RoHS	60	±25%	100	±40%	0.025	3.0	0.8 ±0.1
FB MH1608HM101-T	RoHS	100	±25%	170	±40%	0.035	2.5	0.8 ±0.1
FB MH1608HM151-T	RoHS	150	±25%	270	±40%	0.050	2.1	0.8 ±0.1
FB MH1608HM221-T	RoHS	220	±25%	370	±40%	0.070	1.8	0.8 ±0.1
FB MH1608HM331-T	RoHS	330	±25%	520	±40%	0.130	1.2	0.8 ±0.1
FB MH1608HM471-T	RoHS	470	±25%	750	±40%	0.150	1.0	0.8 ±0.1
FB MH1608HM601-T	RoHS	600	±25%	900	±40%	0.170	0.9	0.8 ±0.1
FB MH1608HM102-T	RoHS	1000	±25%	1200	±40%	0.350	0.6	0.8 ±0.1
FB MH1608HL300-T	RoHS	30	±25%	120	±40%	0.028	2.6	0.8 ±0.1
FB MH1608HL600-T	RoHS	60	±25%	220	±40%	0.045	2.1	0.8 ±0.1
FB MH1608HL121-T	RoHS	120	±25%	540	±40%	0.130	1.2	0.8 ±0.1
FB MH1608HL221-T	RoHS	220	±25%	950	±40%	0.170	0.9	0.8 ±0.1
FB MH1608HL331-T	RoHS	330	±25%	1200	±40%	0.210	0.8	0.8 ±0.1
FB MH1608HL471-T	RoHS	470	±25%	1500	±40%	0.350	0.6	0.8 ±0.1
FB MH1608HL601-T	RoHS	600	±25%	1800	±40%	0.450	0.5	0.8 ±0.1

High impedance type

● FB MH2012

Parts number	EHS	Nominal impedance (Ω)	Impedance tolerance	Measuring frequency [MHz]	DC Resistance [Ω] (max.)	Rated current [A] (max.)	Thickness [mm]
FB MH2012HM800-T	RoHS	80	±25%	100	0.025	2.7	0.85 ±0.2
FB MH2012HM121-T	RoHS	120	±25%	100	0.032	2.5	0.85 ±0.2
FB MH2012HM221-T	RoHS	220	±25%	100	0.060	2.0	0.85 ±0.2
FB MH2012HM331-T	RoHS	330	±25%	100	0.080	1.8	0.85 ±0.2

● FB MH2016

Parts number	EHS	Nominal impedance (Ω)	Impedance tolerance	Measuring frequency [MHz]	DC Resistance [Ω] (max.)	Rated current [A] (max.)	Thickness [mm]
FB MH2016HM121NT	RoHS	120	±30%	100	0.015	4.5	1.6 ±0.2
FB MH2016HM251NT	RoHS	250	±30%	100	0.050	2.0	1.6 ±0.2

● FB MH3216

Parts number	EHS	Nominal impedance (Ω)	Impedance tolerance	Measuring frequency [MHz]	DC Resistance [Ω] (max.)	Rated current [A] (max.)	Thickness [mm]
FB MH3216HM221NT	RoHS	220	±30%	100	0.020	4.0	1.6 ±0.2
FB MH3216HM501NT	RoHS	500	±30%	100	0.070	2.0	1.6 ±0.2

● FB MH3225

Parts number	EHS	Nominal impedance (Ω)	Impedance tolerance	Measuring frequency [MHz]	DC Resistance [Ω] (max.)	Rated current [A] (max.)	Thickness [mm]
FB MH3225HM601NT	RoHS	600	±30%	100	0.042	3.0	2.5 ±0.3
FB MH3225HM102NT	RoHS	1000	±30%	100	0.100	2.0	2.5 ±0.3
FB MH3225HM202NT	RoHS	2000	±30%	100	0.130	1.2	2.5 ±0.3

▶ This catalog contains the typical specification only due to the limitation of space. When you consider the purchase of our products, please check our specification. For details of each product (characteristics graph, reliability information, precautions for use, and so on), see our Web site (<http://www.ty-top.com/>).

■ PARTS NUMBER

● FB MH4516

Parts number	EHS	Nominal impedance (Ω)	Impedance tolerance	Measuring frequency [MHz]	DC Resistance [Ω] (max.)	Rated current [A] (max.)	Thickness [mm]
FB MH4516HM851NT	RoHS	850	±30%	100	0.100	1.5	1.6 ±0.2

● FB MH4525

Parts number	EHS	Nominal impedance (Ω)	Impedance tolerance	Measuring frequency [MHz]	DC Resistance [Ω] (max.)	Rated current [A] (max.)	Thickness [mm]
FB MH4525HM102NT	RoHS	1000	±30%	100	0.060	3.0	2.5 ±0.3
FB MH4525HM162NT	RoHS	1600	±30%	100	0.130	2.0	2.5 ±0.3

● FB MH4532

Parts number	EHS	Nominal impedance (Ω)	Impedance tolerance	Measuring frequency [MHz]	DC Resistance [Ω] (max.)	Rated current [A] (max.)	Thickness [mm]
FB MH4532HM681-T	RoHS	680	±25%	100	0.028	4.0	3.2 ±0.3
FB MH4532HM132-T	RoHS	1300	±25%	100	0.060	3.0	3.2 ±0.3
FB MH4532HM202-T	RoHS	2000	±25%	100	0.130	1.3	3.2 ±0.3

● High current type

Parts number	EHS	Nominal impedance (Ω)	Impedance tolerance	Measuring frequency [MHz]	DC Resistance [Ω] (max.)	Rated current [A] (max.)	Thickness [mm]
FB MJ1608HS220NTR	RoHS	22	±30%	100	0.004	7.5	0.8 ±0.2
FB MJ1608HS280NTR	RoHS	28	±30%	100	0.006	6.0	0.8 ±0.2
FB MJ1608HM180NTR	RoHS	18	±30%	100	0.004	7.5	0.8 ±0.2
FB MJ1608HM230NTR	RoHS	23	±30%	100	0.006	6.0	0.8 ±0.2

► This catalog contains the typical specification only due to the limitation of space. When you consider the purchase of our products, please check our specification. For details of each product (characteristics graph, reliability information, precautions for use, and so on), see our Web site (<http://www.ty-top.com/>).

FB MJ1608

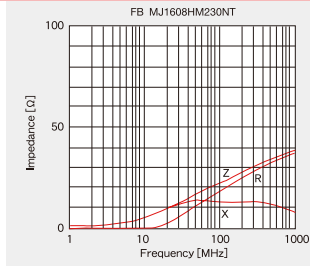
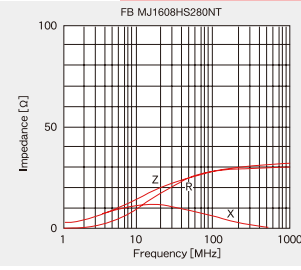

FB MJ2125

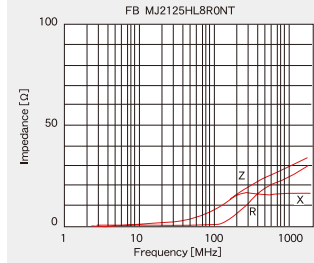
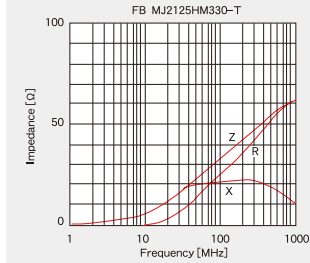
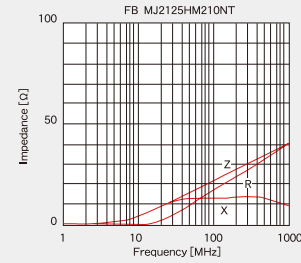
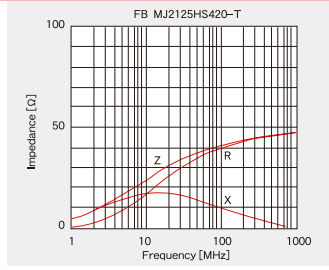
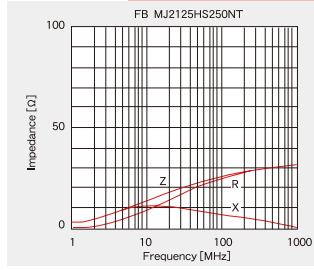

FB MJ3216

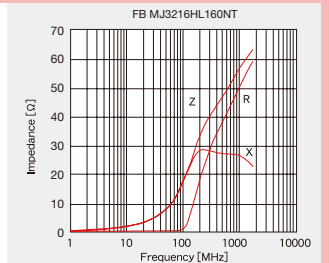
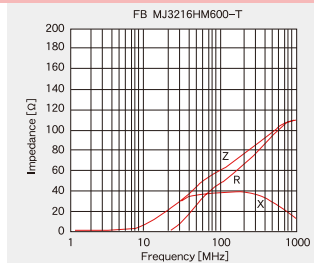
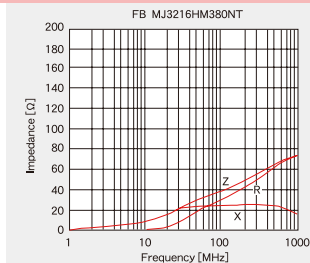
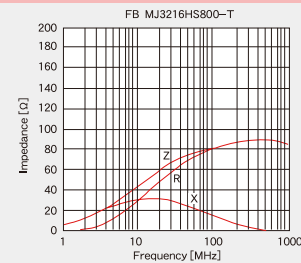
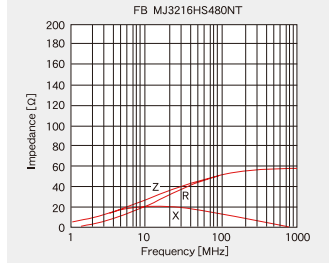

FB MJ4516

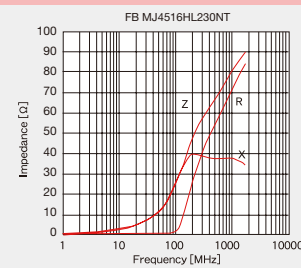
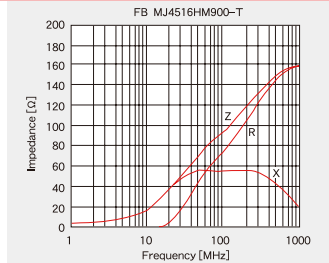
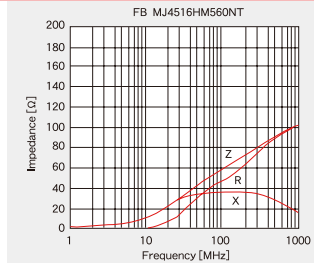
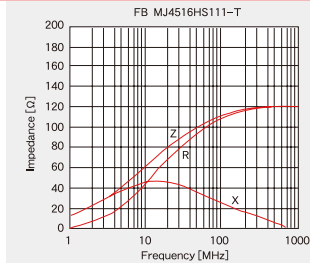
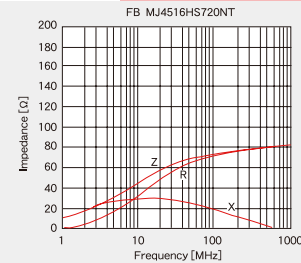

► This catalog contains the typical specification only due to the limitation of space. When you consider the purchase of our products, please check our specification. For details of each product (characteristics graph, reliability information, precautions for use, and so on), see our Web site (<http://www.ty-top.com/>).

High impedance type GHz Band

FB MH1608

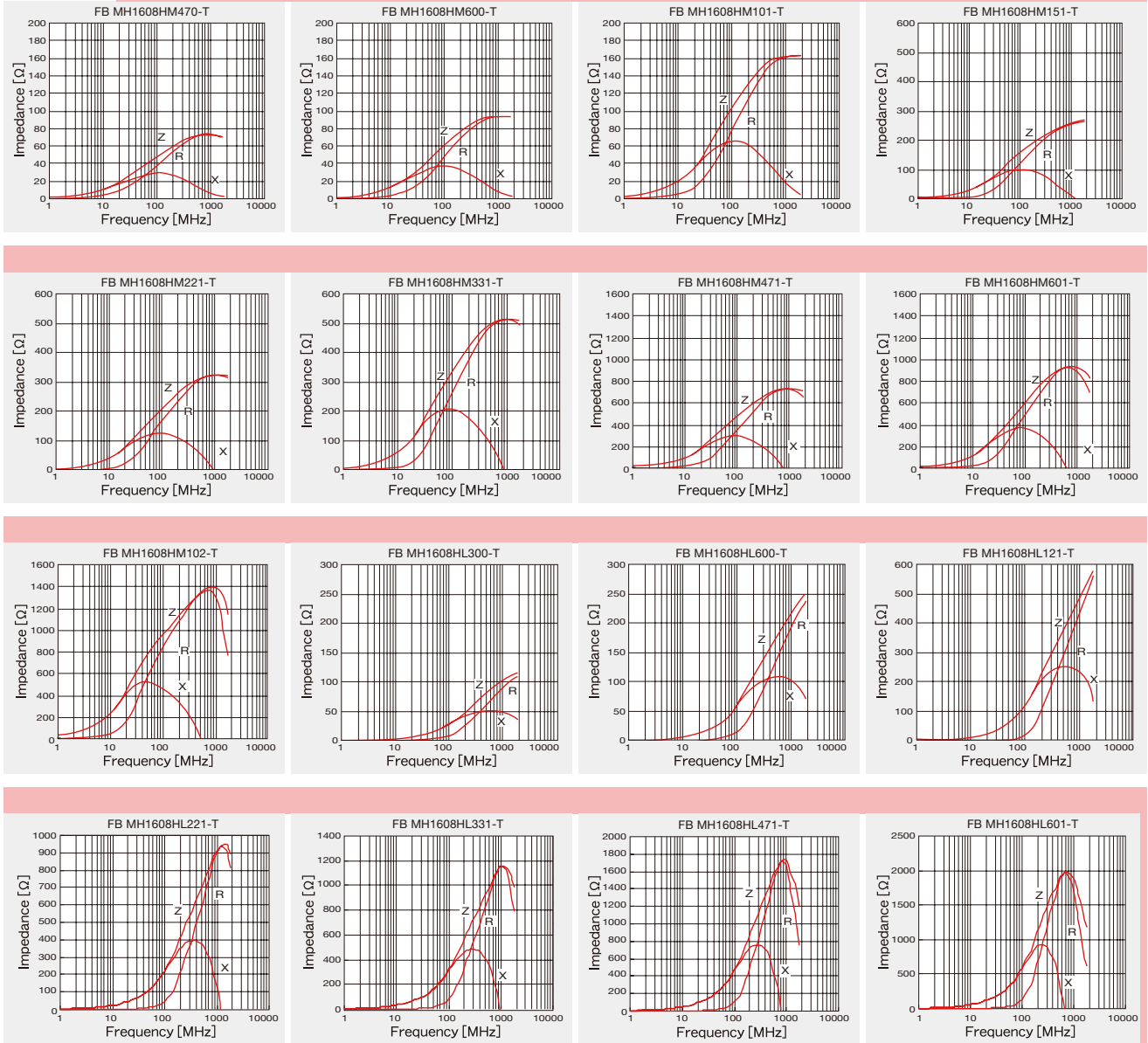

High impedance type

FB MH2012

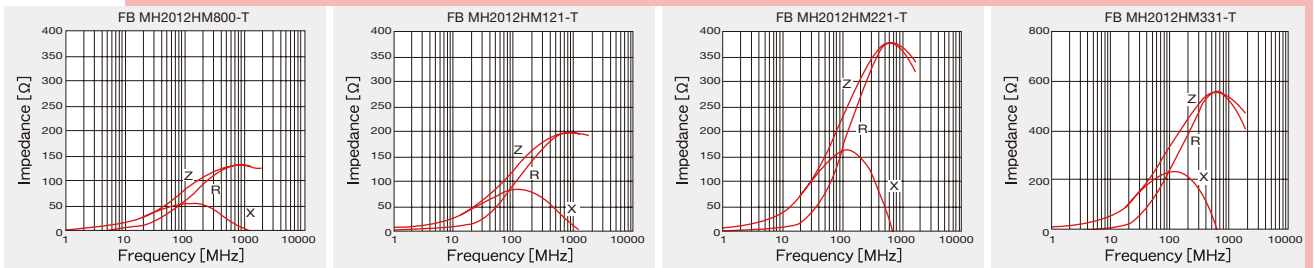

FB MH2016

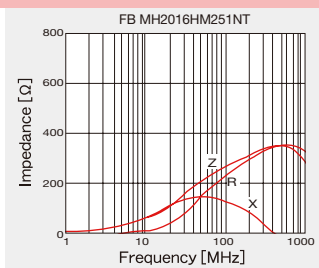
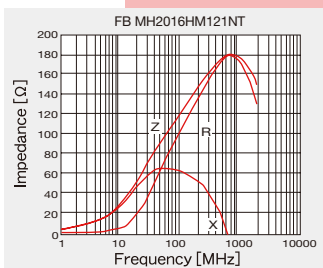

FB MH3216

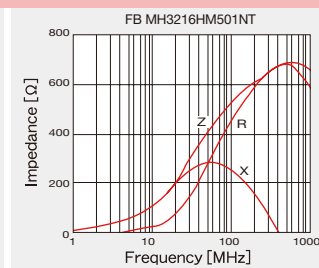
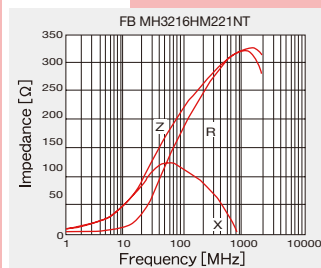

▶ This catalog contains the typical specification only due to the limitation of space. When you consider the purchase of our products, please check our specification. For details of each product (characteristics graph, reliability information, precautions for use, and so on), see our Web site (<http://www.ty-top.com/>).

FB MH3225

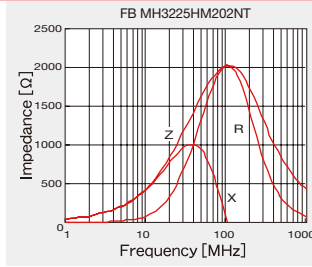
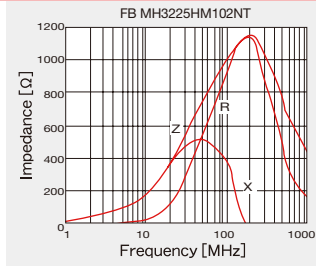
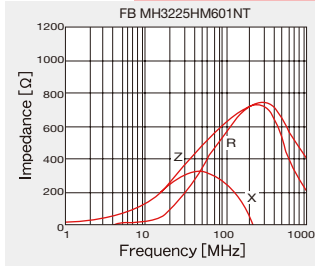

FB MH4516

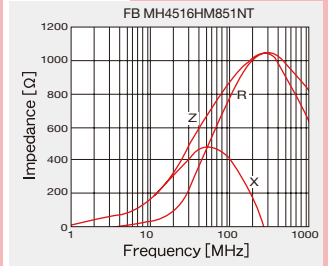

FB MH4525

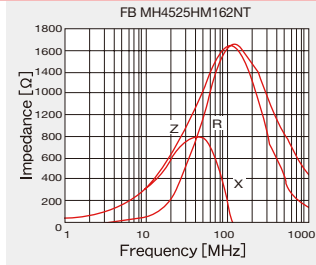
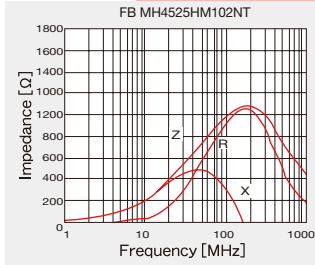

FB MH4532

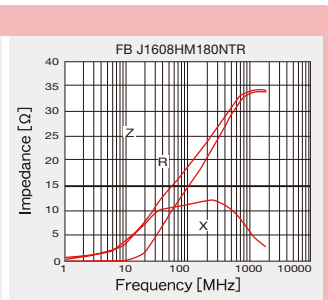
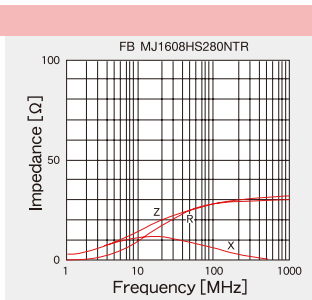
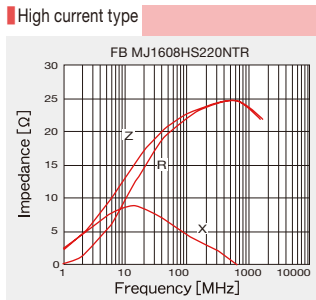
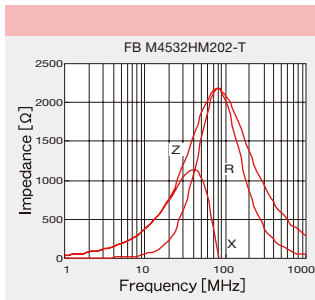
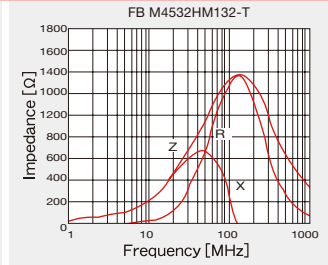
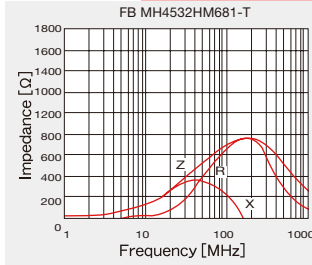

High current type

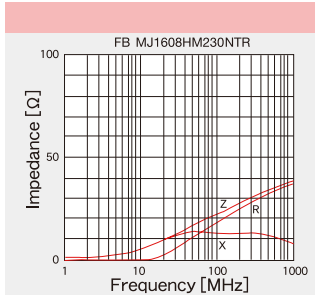

► This catalog contains the typical specification only due to the limitation of space. When you consider the purchase of our products, please check our specification. For details of each product (characteristics graph, reliability information, precautions for use, and so on), see our Web site (<http://www.ty-top.com/>).

CHIP BEAD INDUCTORS FOR POWER LINES (FB SERIES M TYPE)

PACKAGING

① Minimum Quantity

Type	Standard Quantity [pcs]	
	Paper Tape	Embossed Tape
1608 (0603)	4000	—
2125 (0805)	4000	—
2012 (0805)	4000	—
2016 (0806)	—	2000
3216 (1206)	—	2000
3225 (1210)	—	1000
4516 (1806)	—	2000
4525 (1810)	—	1000
4532 (1812)	—	2000

② Tape Material

● Card board carrier tape

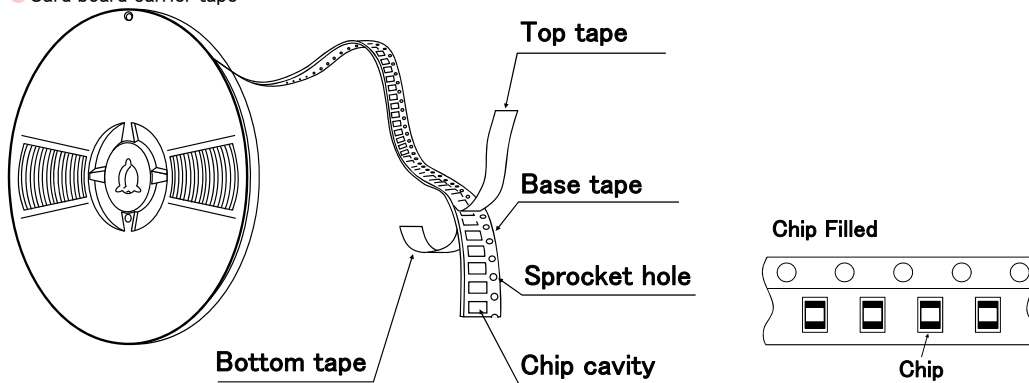

● Embossed tape

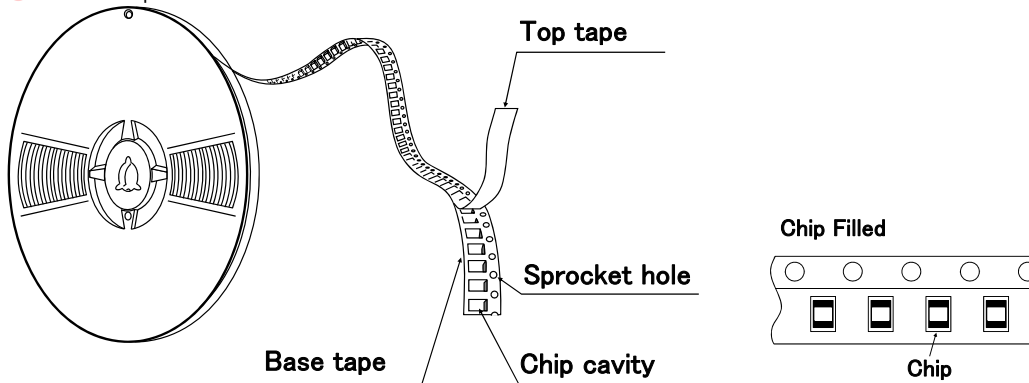

③ Taping Dimensions

● Paper tape (0.315 inches wide)

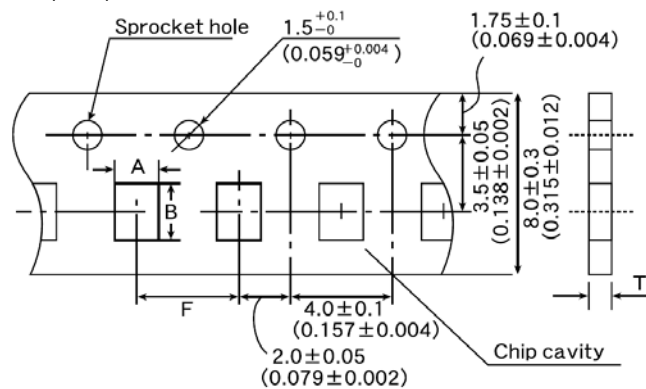

▶ This catalog contains the typical specification only due to the limitation of space. When you consider the purchase of our products, please check our specification. For details of each product (characteristics graph, reliability information, precautions for use, and so on), see our Web site (<http://www.ty-top.com/>).

Type	Chip Cavity		Insertion Pitch	Tape Thickness
	A	B	F	T
FBMJ1608 FBMH1608 (0603)	1.0±0.2 (0.039±0.008)	1.8±0.2 (0.071±0.008)	4.0±0.2 (0.157±0.008)	1.1max (0.043max)
FBMJ2125 FBMH2012 (0805)	1.5±0.2 (0.059±0.008)	2.3±0.2 (0.091±0.008)	4.0±0.2 (0.157±0.008)	1.1max (0.043max)

Unit : mm (inch)

● Embossed tape (0.315 inches wide)

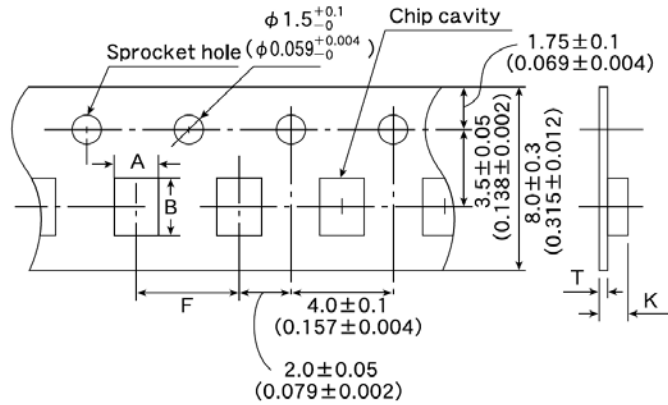

Type	Chip Cavity		Insertion Pitch	Tape Thickness	
	A	B	F	K	T
FBMH2016 (0806)	1.8±0.2 (0.071±0.008)	2.2±0.2 (0.087±0.008)	4.0±0.2 (0.157±0.008)	2.6max (0.102max)	0.6max (0.024max)
FBMJ3216 (1206)	1.9±0.2 (0.075±0.008)	3.5±0.2 (0.138±0.008)	4.0±0.2 (0.157±0.008)	1.5max (0.059max)	0.3max (0.012max)
FBMH3216 (1206)	1.9±0.2 (0.075±0.008)	3.5±0.2 (0.138±0.008)	4.0±0.2 (0.157±0.008)	2.6max (0.102max)	0.6max (0.024max)
FBMH3225 (1210)	2.8±0.2 (0.110±0.008)	3.5±0.2 (0.138±0.008)	4.0±0.2 (0.157±0.008)	4.0max (0.157max)	0.6max (0.024max)

Unit : mm (inch)

● Embossed tape (0.472 inches wide)

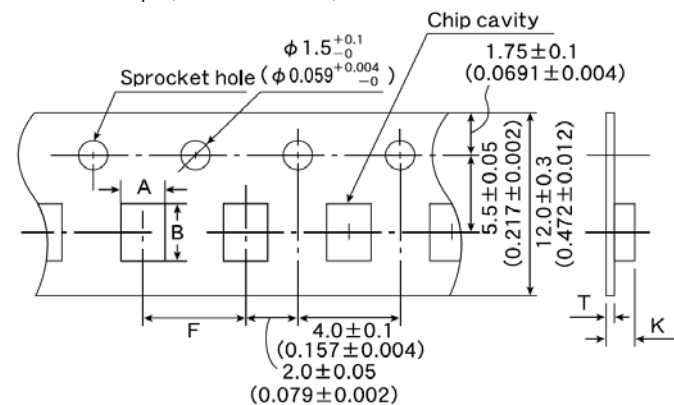

Type	Chip Cavity		Insertion Pitch	Tape Thickness	
	A	B	F	K	T
FBMJ4516 (1806)	1.9±0.2 (0.075±0.008)	4.9±0.2 (0.193±0.008)	4.0±0.2 (0.157±0.008)	1.5max (0.059max)	0.3max (0.012max)
FBMH4516 (1806)	1.9±0.2 (0.075±0.008)	4.9±0.2 (0.193±0.008)	4.0±0.2 (0.157±0.008)	2.6max (0.102max)	0.6max (0.024max)
FBMH4525 (1810)	2.9±0.2 (0.114±0.008)	4.9±0.2 (0.193±0.008)	4.0±0.2 (0.157±0.008)	4.0max (0.157max)	0.6max (0.024max)
FBMH4532 (1812)	3.6±0.2 (0.142±0.008)	4.9±0.2 (0.193±0.008)	8.0±0.2 (0.315±0.008)	4.0max (0.157max)	0.6max (0.024max)

Unit : mm (inch)

▶ This catalog contains the typical specification only due to the limitation of space. When you consider the purchase of our products, please check our specification. For details of each product (characteristics graph, reliability information, precautions for use, and so on), see our Web site (<http://www.ty-top.com/>).

④ Leader and Blank portion

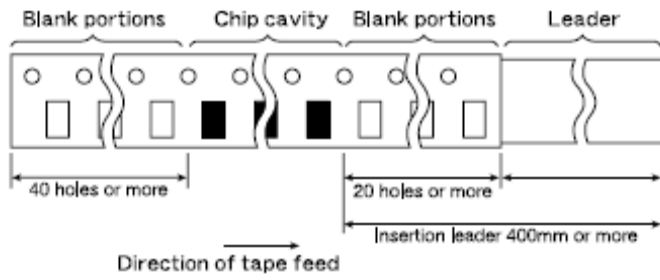

Insertion leader is 400 mm or more (including 20 empty cavities)
Empty cavities at end of reel: 40 holes or more

⑤ Reel size

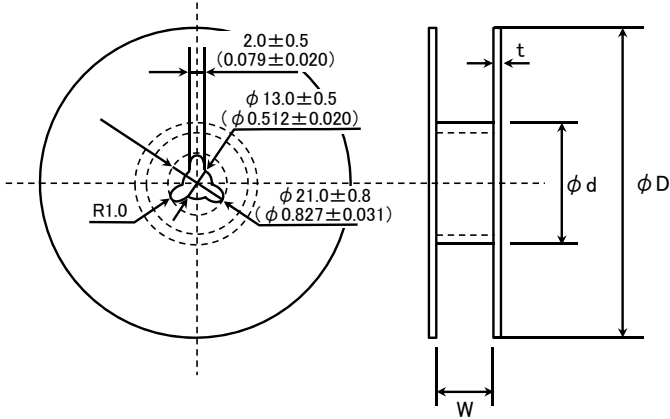

Type	ϕD	ϕd	W	t
FBMJ1608	180+0/-3 (7.09+0/-0.118)	60+1/-0 (2.36+0.039/-0)	10.0±1.5 (0.394±0.059)	2.5max (0.098max)
FBMJ2125			14.0±1.5 (0.551±0.059)	
FBMJ3216				
FBMJ4516			14.0±1.5 (0.551±0.059)	
FBMH1608				
FBMH2012				
FBMH2016				
FBMH3216				
FBMH3225			14.0±1.5 (0.551±0.059)	
FBMH4516				
FBMH4525	330±2.0 (12.99±0.080)	100±1.0 (3.94±0.039)	14.0±2.0 (0.551±0.080)	3.0max (1.181max)
FBMH4532				

Unit : mm (inch)

⑥ Top tape strength

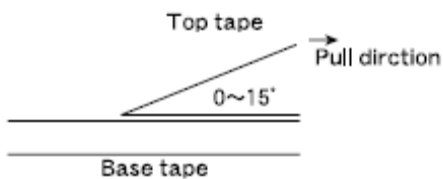

The top tape requires a peel-off force of 0.1 to 0.7N in the direction of the arrow as illustrated below.

CHIP BEAD INDUCTORS FOR POWER LINE (FB SERIES M TYPE)

RELIABILITY DATA

1. Operating Temperature Range	
Specified Value	-40°C ~ +125°C Including self-generated heat
2. Storage Temperature Range	
Specified Value	-40°C ~ +85°C
Test Methods and Remarks	*Note: -5 to +40°C in taped packaging
3. Impedance	
Specified Value	Within the specified tolerance
Test Methods and Remarks	Measuring equipment : Impedance analyzer (HP4291A) or its equivalent Measuring frequency : 100±1 MHz
4. DC Resistance	
Specified Value	Within the specified range
Test Methods and Remarks	Four-terminal method Measuring equipment : Milliohm High-Tester 3226 (Hioki Denki) or its equivalent
5. Rated Current	
Specified Value	Within the specified range
6. Vibration	
Specified Value	Appearance : No significant abnormality Impedance change : Within ±30% of the initial value
Test Methods and Remarks	According to JIS C60068-2-6. Vibration type : A Time : 2 hrs each in X,Y, and Z directions Total: 6 hrs Frequency range : 10 to 55 to 10Hz (/min.) Amplitude : 1.5 mm (shall not exceed acceleration 196m/s ²) Mounting method : Soldering onto PC board
7. Solderability	
Specified Value	90% or more of immersed surface of terminal electrode shall be covered with fresh solder.
Test Methods and Remarks	Solder temperature : 230±5°C Immersion time : 4±1 sec. Preconditioning : Immersion into flux. Immersion and Removal speed : 25mm/sec.
8. Resistance to Soldering Heat	
Specified Value	Appearance : No significant abnormality Impedance change : Within ±30% of the initial value
Test Methods and Remarks	Preheating : 150°C for 3 min. Resistance to Soldering Heat : 260±5°C Duration : 10±0.5 sec. Preconditioning : Immersion into flux. Immersion and Removal speed : 25mm/sec. Recovery : 2 to 3 hrs of recovery under the standard condition after the test.

▶ This catalog contains the typical specification only due to the limitation of space. When you consider the purchase of our products, please check our specification. For details of each product (characteristics graph, reliability information, precautions for use, and so on), see our Web site (<http://www.ty-top.com/>).

9. Thermal Shock															
Specified Value	Appearance : No significant abnormality Impedance change : Within +50/−10% of the initial value														
Test Methods and Remarks	According to JIS C60068-2-14. Conditions for 1 cycle														
	<table border="1"> <thead> <tr> <th>Step</th> <th>Temperature (°C)</th> <th>Duration (min.)</th> </tr> </thead> <tbody> <tr> <td>1</td> <td>−40±3°C</td> <td>30±3</td> </tr> <tr> <td>2</td> <td>Room Temperature</td> <td>Within 3</td> </tr> <tr> <td>3</td> <td>85±2°C</td> <td>30±3</td> </tr> <tr> <td>4</td> <td>Room Temperature</td> <td>Within 3</td> </tr> </tbody> </table>	Step	Temperature (°C)	Duration (min.)	1	−40±3°C	30±3	2	Room Temperature	Within 3	3	85±2°C	30±3	4	Room Temperature
Step	Temperature (°C)	Duration (min.)													
1	−40±3°C	30±3													
2	Room Temperature	Within 3													
3	85±2°C	30±3													
4	Room Temperature	Within 3													
	Number of cycles : 100 Mounting method : Soldering onto PC board Recovery : 2 to 3 hrs of recovery under the standard condition after the removal from test chamber.														

10. Resistance to Humidity (steady state)	
Specified Value	Appearances : No significant abnormality Impedance change : Within ±30% of the initial value
Test Methods and Remarks	Temperature : 40±2°C Humidity : 90 to 95% RH Duration : 500+24/−0 Mounting method : Soldering onto PC board Recovery : 2 to 3 hrs of recovery under the standard condition after the removal from test chamber.

11. Loading under Damp Heat	
Specified Value	Appearance : No significant abnormality Impedance change : Within ±30% of the initial value
Test Methods and Remarks	Temperature : 40±2°C Humidity : 90 to 95%RH Applied current : Rated current Duration : 500+24/−0 hrs Mounting method : Soldering onto PC board Recovery : 2 to 3hrs of recovery under the standard condition after the removal from test chamber.

12. High Temperature Loading Test	
Specified Value	Appearance : No significant abnormality Impedance change : Within ±30% of the initial value
Test Methods and Remarks	Temperature : 85±2°C Duration : 500+24/−0 hrs Applied current : Rated current Mounting method : Soldering onto PC board Recovery : 2 to 3 hrs of recovery under the standard condition after the removal from test chamber.

13. Bending Strength	
Specified Value	Appearance : No mechanical damage.
Test Methods and Remarks	Warp : 2mm Testing board : Glass epoxy-resin substrate Thickness : 0.8mm

▶ This catalog contains the typical specification only due to the limitation of space. When you consider the purchase of our products, please check our specification.
For details of each product (characteristics graph, reliability information, precautions for use, and so on), see our Web site (<http://www.ty-top.com/>).

14. Adhesion of Electrode

Specified Value No separation or indication of separation of electrode.

Test Methods and Remarks

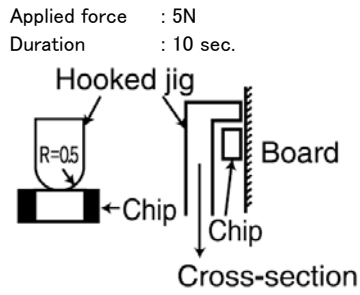

Note on standard condition: "standard condition" referred to herein is defined as follows:

5 to 35°C of temperature, 45 to 85% relative humidity and 86 to 106kPa of air pressure.

When there are questions concerning measurement results:

In order to provide correlation data, the test shall be conducted under condition of $20 \pm 2^\circ\text{C}$ of temperature, 60 to 70% relative humidity and 86 to 106kPa of air pressure. Unless otherwise specified, all the tests are conducted under the "standard condition."

CHIP BEAD INDUCTORS FOR POWER LINE (FB SERIES M TYPE)

PRECAUTIONS

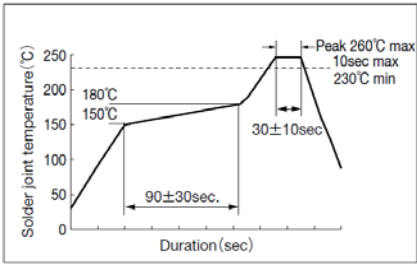
1. Circuit Design	
Precautions	<ul style="list-style-type: none"> ◆ Operating environment <ol style="list-style-type: none"> 1. The products described in this specification are intended for use in general electronic equipment, (office supply equipment, telecommunications systems, measuring equipment, and household equipment). They are not intended for use in mission-critical equipment or systems requiring special quality and high reliability (traffic systems, safety equipment, aerospace systems, nuclear control systems and medical equipment including life-support systems,) where product failure might result in loss of life, injury or damage. For such uses, contact TAIYO YUDEN Sales Department in advance. ◆ Rated current <ol style="list-style-type: none"> 1. Rated current of this product is shown in this catalogue, but please be sure to have the base board designed with adequate inspection in case of the generation of heat becomes high within the rated current range when the base board is in high resistance or in bad heating conditions.
2. PCB Design	
Precautions	<ul style="list-style-type: none"> ◆ Land pattern design <ol style="list-style-type: none"> 1. Please refer to a recommended land pattern.
3. Considerations for automatic placement	
Precautions	<ul style="list-style-type: none"> ◆ Adjustment of mounting machine <ol style="list-style-type: none"> 1. Excessive impact load should not be imposed on the products when mounting onto the PC boards. 2. Mounting and soldering conditions should be checked beforehand.
Technical considerations	<ul style="list-style-type: none"> ◆ Adjustment of mounting machine <ol style="list-style-type: none"> 1. When installing products, care should be taken not to apply distortion stress as it may deform the products.
4. Soldering	
Precautions	<ul style="list-style-type: none"> ◆ Wave soldering <ol style="list-style-type: none"> 1. Please refer to the specifications in the catalog for a wave soldering. ◆ Reflow soldering <ol style="list-style-type: none"> 1. Please contact any of our offices for a reflow soldering, and refer to the recommended condition specified. ◆ Lead free soldering <ol style="list-style-type: none"> 1. When using products with lead free soldering, we request to use them after confirming adhesion, temperature of resistance to soldering heat, etc. sufficiently. ◆ Preheating when soldering <p>Heating : The temperature difference between soldering and remaining heat should not be greater than 150°C.</p> <p>Cooling : The temperature difference between the components and cleaning process should not be greater than 100°C.</p> ◆ Recommended conditions for using a soldering iron <p>Put the soldering iron on the land-pattern.</p> <p>Soldering iron's temperature – Below 350°C</p> <p>Duration – 3 seconds or less</p> <p>The soldering iron should not directly touch the inductor.</p>
Technical considerations	<ul style="list-style-type: none"> ◆ Wave, Reflow, Lead free soldering <ol style="list-style-type: none"> 1. If products are used beyond the range of the recommended conditions, heat stresses may deform the products, and consequently degrade the reliability of the products. <p>【Recommended reflow condition】</p>  ◆ Preheating when soldering <ol style="list-style-type: none"> 1. There is a case that products get damaged by a heat shock. ◆ Recommended conditions for using a soldering iron <ol style="list-style-type: none"> 1. If products are used beyond the range of the recommended conditions, heat stresses may deform the products, and consequently degrade the reliability of the products.

▶ This catalog contains the typical specification only due to the limitation of space. When you consider the purchase of our products, please check our specification. For details of each product (characteristics graph, reliability information, precautions for use, and so on), see our Web site (<http://www.ty-top.com/>).

5. Handling	
Precautions	<ul style="list-style-type: none"> ◆ Handling <ol style="list-style-type: none"> 1. Keep the inductors away from all magnets and magnetic objects. ◆ Setting PC boards <ol style="list-style-type: none"> 1. When setting a chip mounted base board, please make sure that there is no residual stress to the chip by distortion in the board or at screw part. ◆ Breakaway PC boards (splitting along perforations) <ol style="list-style-type: none"> 1. When splitting the PC board after mounting inductors, care should be taken not to give any stresses of deflection or twisting to the board. 2. Board separation should not be done manually, but by using the appropriate devices. ◆ Mechanical considerations <ol style="list-style-type: none"> 1. Please do not give the inductors any excessive mechanical shocks.
Technical considerations	<ul style="list-style-type: none"> ◆ Handling <ol style="list-style-type: none"> 1. There is a case that a characteristic varies with magnetic influence. ◆ Setting PC boards <ol style="list-style-type: none"> 1. There is a case that a characteristic varies with residual stress. ◆ Breakaway PC boards (splitting along perforations) <ol style="list-style-type: none"> 1. Planning pattern configurations and the position of products should be carefully performed to minimize stress. ◆ Mechanical considerations <ol style="list-style-type: none"> 1. There is a case to be damaged by a mechanical shock.
6. Storage conditions	
Precautions	<ul style="list-style-type: none"> ◆ Storage <ol style="list-style-type: none"> 1. To maintain the solderability of terminal electrodes and to keep the packing material in good condition, temperature and humidity in the storage area should be controlled. <ul style="list-style-type: none"> • Recommended conditions Ambient temperature 0~40°C Humidity Below 70% RH <p>The ambient temperature must be kept below 30°C. Even under ideal storage conditions, solderability of products electrodes may decrease as time passes.</p> <p>For this reason, inductors should be used within 6 months from the time of delivery.</p>
Technical considerations	<ul style="list-style-type: none"> ◆ Storage <ol style="list-style-type: none"> 1. Under a high temperature and humidity environment, problems such as reduced solderability caused by oxidation of terminal electrodes and deterioration of taping/packaging materials may take place.

LEADED FERRITE BEAD INDUCTORS(FB SERIES A TYPE / R TYPE)



WAVE

■ PARTS NUMBER

*Operating Temp. : -25~+85°C (Including self-generated heat)

F	B	A	0	4	H	A	4	5	0	B	B	-	0	0
①	②	③	④	⑤	⑥	⑦								

△=Blank space

① Series name

Code	Series name
FB	Ferrite bead

② Shape

Code	Shape
A	Axial lead
R	Radial lead

③ Dimensions of core (D)

Code	Dimensions of core (D) [mm]
03	φ 2.5
04	φ 3.5
05	5.0
06	6.0
07	7.5

④ Material

Code	Material
HA	Refer to impedance curves for material differences
VA	

⑤ Nominal impedance

Code (example)	Nominal impedance [Ω min.]
850	85
121	120

Excluding 03type

⑥ Lead configuration

Code	Lead configurations [mm]
AB	Straight lead (26mm lead space) / ammo
BB	Straight lead (52mm lead space) / ammo
KD	Formed lead (10mm pitch) / bulk
KE	Formed lead (12.5mm pitch) / bulk
KF	Formed lead / bulk (15.0mm pitch) / bulk
NA	Lead (2.5mm pitch)/bulk (FBR) Straight lead / bulk (FBA)
NB	Formed lead (crimped) / bulk
SA	Straight lead (FBR05 type) / ammo
SB	Straight lead (FBR07 type) / ammo
TB	Straight lead (FBR07 type) / ammo
UB	Radial lead formed / ammo
US	Formed lead (crimped) / bulk
VB	Dual side lead formed (crimped) / ammo
VS	Formed lead / bulk

⑦ Internal code

Code	Internal code
-00	Standard

■ STANDARD EXTERNAL DIMENSIONS / STANDARD QUANTITY

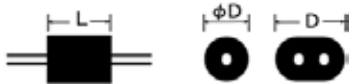

Type	Configurations				Dimensions		Standard Quantity (pcs)					
	Taping		Bulk		D	L	Type	Lead Configuration	Bulk	Taped Ammo		
	Straight	Formed	Straight	Formed								
FBA	03HA450 □ -00 03VA450 □ -00			NA		2.5±0.2 (0.098±0.008)	4.5±0.3 (0.177±0.012)	FBA03	NA, KD, US	1000	—	
									KE, KF, VS	500	—	
										AB, BB	—	2000
										UB, VB	—	3000
	04HA450 □ -00 04VA450 □ -00			NA		3.5±0.2 (0.138±0.008)	4.5±0.3 (0.177±0.012)	FBA04	NA, KD, US	1000	—	
									KE, KF, VS	500	—	
	04HA600 □ -00 04VA600 □ -00			NA		3.5±0.2 (0.138±0.008)	6.0 ^{+0.3} ₋₀ (0.236 ^{+0.009} ₋₀)			AB, BB	—	1000
									UB, VB	—	3000	
	04HA900 □ -00 04VA900 □ -00			NA		3.5±0.2 (0.138±0.008)	9.0±0.5 (0.354±0.020)		UB, VB	—	3000	

▶ This catalog contains the typical specification only due to the limitation of space. When you consider the purchase of our products, please check our specification. For details of each product (characteristics graph, reliability information, precautions for use, and so on), see our Web site (<http://www.ty-top.com/>).

Type	Configurations				Dimensions		Standard Quantity (pcs)				
	Taping		Bulk		D	L	Type	Lead Configuration	Bulk	Taped Ammo	
	Straight	Formed	Straight	Formed							
FBR	05VA121□-00	—	 SA P: 12.7 (0.500)	—	 NA F: 2.5 (0.098)	5.0 max. (0.197 max.)	7.5 (0.295)	FBR05	NA	1000	—
									SA	—	2000
	06HA850NA-00 06VA850NA-00	—	—	—	 NA F: 2.5 (0.098)	6.0±0.5 (0.236±0.020)	5.0 (0.197)	FBR06	NA	1000	—
	06HA121NA-00 06VA121NA-00								7.0 (0.276)		
	07HA850□-00 07VA850□-00	—	 SB, TB P: 12.7 (0.500) H: SB 18, TB 16±0.5	—	 NB F: 5.0 (0.197)	7.5±0.5 (0.295±0.020)	5.5 (0.217)	FBR07	NB	1000	—
07HA121□-00 07VA121□-00							7.5 (0.295)		SB	—	2000

Unit: mm (inch)

□ Please specify the lead configuration code.

Note: Lead diameter (ϕ d) shall fall within a range of 0.65mm±0.05mm, FBR07 types however, will have a lead diameter (ϕ d) range of 0.6mm±0.05mm.

■ PARTS NUMBER

● FBA

Parts number	EHS	Nominal impedance [Ω] (min.)	Impedance measuring frequency [MHz]		Rated current [A] (max.)		DC Resistance [Ω] (max.)	Rated current [mA] (min.)
			Material		Material			
			HA	VA	HA	VA		
FBA03△450□-00	RoHS	35	50	100	7.0	7.0	0.01	1.0
FBA04△450□-00	RoHS	45	50	100	7.0	7.0	0.01	1.0
FBA04△600□-00	RoHS	60	50	100	7.0	7.0	0.01	1.0
FBA04△900□-00	RoHS	90	50	100	7.0	7.0	0.01	1.0

● FBR

Parts number	EHS	Nominal impedance [Ω] (min.)	Impedance measuring frequency [MHz]		Rated current [A] (max.)		DC Resistance [Ω] (max.)	Rated current [mA] (min.)
			Material		Material			
			HA	VA	HA	VA		
FBR05VA121□-00	RoHS	120	—	100	—	7.0	0.01	1.0
FBR06△850NA-00	RoHS	85	50	100	7.0	7.0	0.01	1.0
FBR06△121NA-00	RoHS	120	50	100	7.0	7.0	0.01	1.0
FBR07△850□-00	RoHS	85	50	100	7.0	7.0	0.01	1.0
FBR07△121□-00	RoHS	120	50	100	7.0	7.0	0.01	1.0

※△ Please specify material codes (HA,VA) and □ lead configuration code.

LEADED FERRITE BEAD INDUCTORS (FB SERIES A TYPE / R TYPE)

PACKAGING

① Minimum Quantity

● Axial lead (FBA)

Type	Lead Configuration	Standard quantity [pcs]	
		Bulk	Taped Ammo
FBA03	NA, KD, US	1000	—
	KE, KF, VS	500	—
	AB, BB	—	2000
	UB, VB	—	3000
FBA04	NA, KD, US	1000	—
	KE, KF, VS	500	—
	AB, BB	—	1000
	VB, UB	—	3000

● Radial lead (FBR)

Type	Lead Configuration	Standard quantity [pcs]	
		Bulk	Taped Ammo
FBR05	NA	1000	—
	SA	—	2000
FBR06	NA	1000	—
FBR07	NB	1000	—
	SB, TB	—	2000

② Bulk dimensions

Axial lead (FBA)

● NA

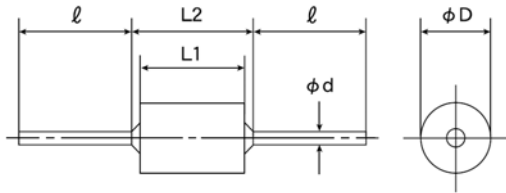

Type	Dimensions				
	ϕD	L1	L2	ϕd	l
FBA03□450	2.5 ± 0.2 (0.098 ± 0.008)	4.5 ± 0.3 (0.177 ± 0.012)	6.5 max. (0.256 max.)	0.65 ± 0.05 (0.026 ± 0.002)	18 min. (0.709 min.)
FBA04□450	3.5 ± 0.2 (0.138 ± 0.008)	4.5 ± 0.3 (0.177 ± 0.012)	6.5 max. (0.256 max.)		
FBA04□600	3.5 ± 0.2 (0.138 ± 0.008)	$6.0 + 0.5 / -0$ ($0.236 + 0.020 / -0$)	8.5 max. (0.335 max.)		
FBA04□900	3.5 ± 0.2 (0.138 ± 0.008)	9.0 ± 0.5 (0.354 ± 0.020)	11.0 max. (0.433 max.)		

Unit: mm (inch)

● US

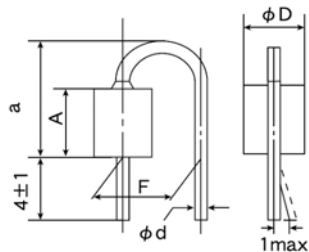

Type	Dimensions				
	ϕD	A	a	F	ϕd
FBA03□450	2.5 ± 0.2 (0.098 ± 0.008)	4.5 ± 0.3 (0.177 ± 0.012)	9.0 max. (0.354 max.)	5.0 ± 1.0 (0.197 ± 0.039)	0.65 ± 0.05 (0.026 ± 0.002)
FBA04□450	3.5 ± 0.2 (0.138 ± 0.008)	4.5 ± 0.3 (0.177 ± 0.012)	9.0 max. (0.354 max.)		

Unit: mm (inch)

▶ This catalog contains the typical specification only due to the limitation of space. When you consider the purchase of our products, please check our specification. For details of each product (characteristics graph, reliability information, precautions for use, and so on), see our Web site (<http://www.ty-top.com/>).

● KD/KE/KF

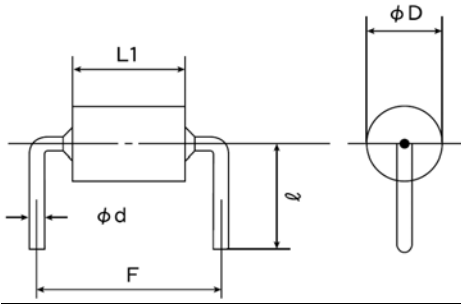

Type	Lead Symbol	Dimensions				
		ϕD	F	L1	ϕd	l
FBA03□450	KD	2.5±0.2 (0.098±0.008)	10.0±1.0 (0.394±0.039)	4.5±0.3 (0.177±0.012)	0.65±0.05 (0.026±0.020)	7.0±2.0 (0.276±0.079)
FBA04□450		3.5±0.2 (0.138±0.008)	10.0±1.0 (0.394±0.039)	4.5±0.3 (0.177±0.012)		7.5±2.0 (0.295±0.079)
FBA04□600		3.5±0.2 (0.138±0.008)	10.0±1.0 (0.394±0.039)	6.0+0.5/-0 (0.236+0.020/-0)		7.5±2.0 (0.295±0.079)
FBA03□450	KE	2.5±0.2 (0.098±0.008)	12.5±1.0 (0.492±0.039)	4.5±0.3 (0.177±0.012)	0.65±0.05 (0.026±0.020)	7.0±2.0 (0.276±0.079)
FBA04□450		3.5±0.2 (0.138±0.008)	12.5±1.0 (0.492±0.039)	4.5±0.3 (0.177±0.012)		7.5±2.0 (0.295±0.079)
FBA04□600		3.5±0.2 (0.138±0.008)	12.5±1.0 (0.492±0.039)	6.0+0.5/-0 (0.236+0.020/-0)		7.5±2.0 (0.295±0.079)
FBA04□900		3.5±0.2 (0.138±0.008)	12.5±1.0 (0.492±0.039)	9.0±0.5 (0.354±0.020)		7.5±2.0 (0.295±0.079)
FBA03□450	KF	2.5±0.2 (0.098±0.008)	15.0±1.0 (0.591±0.039)	4.5±0.3 (0.177±0.012)	0.65±0.05 (0.026±0.020)	7.0±2.0 (0.276±0.079)
FBA04□450		3.5±0.2 (0.138±0.008)	15.0±1.0 (0.591±0.039)	4.5±0.3 (0.177±0.012)		7.5±2.0 (0.295±0.079)
FBA04□600		3.5±0.2 (0.138±0.008)	15.0±1.0 (0.591±0.039)	6.0+0.5/-0 (0.236+0.020/-0)		7.5±2.0 (0.295±0.079)
FBA04□900		3.5±0.2 (0.138±0.008)	15.0±1.0 (0.591±0.039)	9.0±0.5 (0.354±0.020)		7.5±2.0 (0.295±0.079)

Unit : mm (inch)

● VS

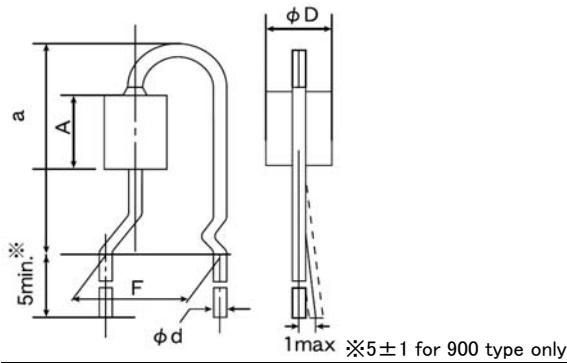

Type	Dimensions				
	ϕD	A	a	F	ϕd
FBA03□450	2.5±0.2 (0.098±0.008)	4.5±0.3 (0.177±0.012)	12.5 max. (0.492 max.)	5.0±1.0 (0.197±0.039)	0.65±0.05 (0.026±0.002)
FBA04□450	3.5±0.2 (0.138±0.008)	4.5±0.3 (0.177±0.012)	12.5 max. (0.492 max.)	5.0±1.0 (0.197±0.039)	0.65±0.05 (0.026±0.002)
FBA04□600	3.5±0.2 (0.138±0.008)	6.0+0.5/-0 (0.236+0.020/-0)	12.5 max. (0.492 max.)	5.0±1.0 (0.197±0.039)	0.65±0.05 (0.026±0.002)
FBA04□900	3.5±0.2 (0.138±0.008)	9.0±0.5 (0.354±0.020)	16.0 max. (0.630 max.)	5.0±1.0 (0.197±0.039)	0.65±0.05 (0.026±0.002)

Unit : mm (inch)

Radial lead (FBR)

● NA

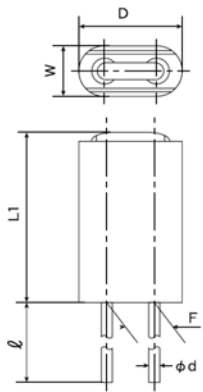

Type	Dimensions					
	D	L1	φd	l	W	F
FBR05VA121	5.0 max. (0.197 max.)	9.0 max. (0.354 max.)	0.65±0.05 (0.026±0.002)	10.0+3/-5 (0.394+0.118/-0.197)	2.5 max. (0.098 max.)	2.5±1.0 (0.098±0.039)
FBR06□850	6.0±0.5 (0.236±0.020)	7.0 max. (0.276 max.)	0.65±0.05 (0.026±0.002)	10.0+3/-5 (0.394+0.118/-0.197)	3.0±0.5 (0.118±0.020)	2.5±1.0 (0.098±0.039)
FBR06□121	6.0±0.5 (0.236±0.020)	9.0 max. (0.354 max.)	0.65±0.05 (0.026±0.002)	10.0+3/-5 (0.394+0.118/-0.197)	3.0±0.5 (0.118±0.020)	2.5±1.0 (0.098±0.039)

Unit: mm (inch)

● NB

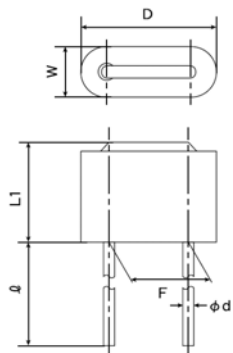

Type	Dimensions					
	D	L1	φd	l	W	F
FBR07□850	7.5±0.5 (0.295±0.020)	7.0 max. (0.276 max.)	0.6±0.05 (0.024±0.002)	5.0+1/-2 (0.197+0.039/-0.079)	2.5 max. (0.098 max.)	5.0+1/-0.5 (0.197+0.039/-0.020)
FBR07□121	7.5±0.5 (0.295±0.020)	9.0 max. (0.354 max.)	0.6±0.05 (0.024±0.002)	5.0+1/-2 (0.197+0.039/-0.079)	2.5 max. (0.098 max.)	5.0+1/-0.5 (0.197+0.039/-0.020)

Unit: mm (inch)

③ Taping Dimensions

● AB (a: 26mm) (1.02inch lead space)

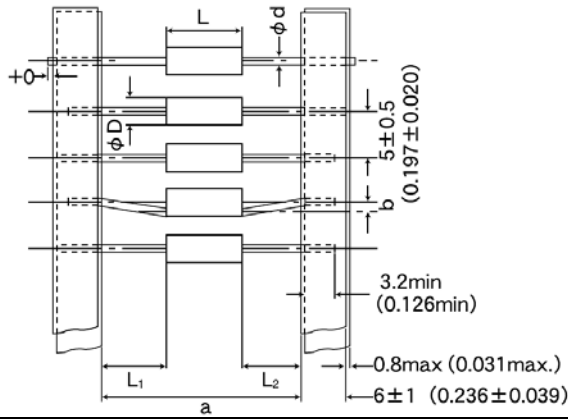

Type	Dimensions						Minimum insertion pitch
	ϕD	L	a	b	$ L_1-L_2 $	ϕd	
FBA03	2.5 ± 0.2 (0.098 ± 0.008)	4.5 ± 0.3 (0.177 ± 0.012)	$26.0 + 1.5 / -0$ ($1.02 + 0.059 / -0$)	0.8max (0.031max)	1.0 max (0.039 max)	0.65 ± 0.05 (0.026 ± 0.002)	10.0 (0.394)
FBA04□450	3.5 ± 0.2 (0.138 ± 0.008)	4.5 ± 0.3 (0.177 ± 0.012)	$26.0 + 1.5 / -0$ ($1.02 + 0.059 / -0$)	0.8max (0.031max)	1.0 max (0.039 max)	0.65 ± 0.05 (0.026 ± 0.002)	10.0 (0.394)
FBA04□600		$6.0 + 0.5 / -0$ ($0.236 + 0.020 / -0$)	$26.0 + 1.5 / -0$ ($1.02 + 0.059 / -0$)	0.8max (0.031max)	1.0 max (0.039 max)	0.65 ± 0.05 (0.026 ± 0.002)	10.0 (0.394)
FBA04□900		9.0 ± 0.5 (0.354 ± 0.020)	$26.0 + 1.5 / -0$ ($1.02 + 0.059 / -0$)	0.8max (0.031max)	1.0 max (0.039 max)	0.65 ± 0.05 (0.026 ± 0.002)	12.5 (0.492)

Unit: mm (inch)

● BB (a: 52mm) (2.05inches lead space)

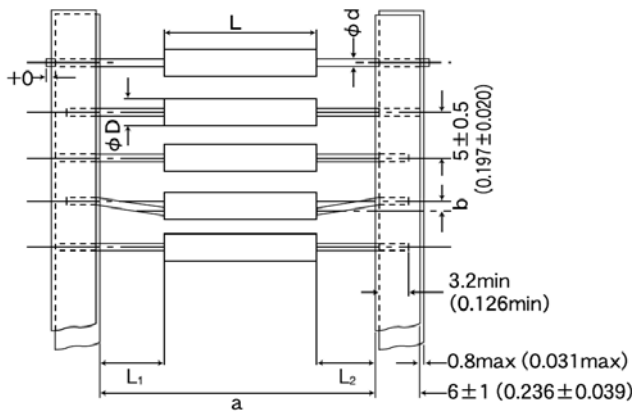

Type	Dimensions						Minimum insertion pitch
	ϕD	L	a	b	$ L_1-L_2 $	ϕd	
FBA03	2.5 ± 0.2 (0.098 ± 0.008)	4.5 ± 0.3 (0.177 ± 0.012)	$52.0 + 2 / -1$ ($2.05 + 0.079 / -0.039$)	1.2 max (0.047 max)	1.0 max (0.039 max)	0.65 ± 0.05 (0.026 ± 0.002)	10.0 (0.394)
FBA04□450	3.5 ± 0.2 (0.138 ± 0.008)	4.5 ± 0.3 (0.177 ± 0.012)	$52.0 + 2 / -1$ ($2.05 + 0.079 / -0.039$)	1.2max (0.047max)	1.0 max (0.039 max)	0.65 ± 0.05 (0.026 ± 0.002)	10.0 (0.394)
FBA04□600		$6.0 + 0.5 / -0$ ($0.236 + 0.020 / -0$)	$52.0 + 2 / -1$ ($2.05 + 0.079 / -0.039$)	1.2max (0.047 max)	1.0 max (0.039 max)	0.65 ± 0.05 (0.026 ± 0.002)	10.0 (0.394)
FBA04□900		9.0 ± 0.5 (0.354 ± 0.020)	$52.0 + 2 / -1$ ($2.05 + 0.079 / -0.039$)	1.2max (0.047 max)	1.0 max (0.039 max)	0.65 ± 0.05 (0.026 ± 0.002)	12.5 (0.492)

Unit: mm (inch)

● SA (F: 2.5mm pitch) (0.098 inches)

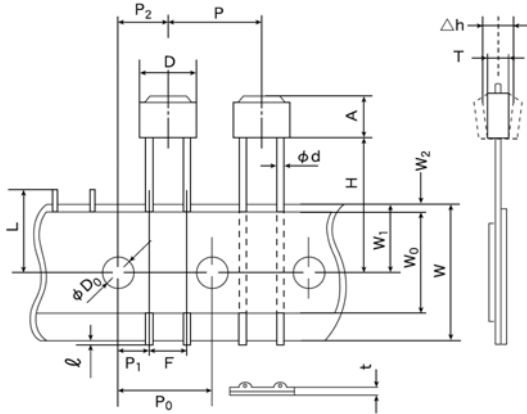

Type	Symbol	Dimensions	Symbol	Dimensions	Symbol	Dimensions
FBR05	A	121: 9.0 max. (0.354 max.)	P ₂	6.35±1.3 (0.250±0.051)	ℓ	1.0 max. (0.039 max.)
	T	2.5 max. (0.098 max.)	F	2.5+1.0/−0.5 (0.098+0.039/−0.020)	φD ₀	4.0±0.3 (0.157±0.012)
	D	5.0 max. (0.197 max.)	Δh	0.0±2.0 (0.0±0.079)	φd	0.65±0.05 (0.026±0.002)
	H	18.0+2.0/−0 (0.709+0.079/−0)	W	18.0+1.0/−0.5 (0.709+0.039/−0.020)	L	11.0 max. (0.433 max.)
	P	12.7±1.0 (0.500±0.039)	W ₀	12.5 min. (0.492 min.)	t	0.7±0.2 (0.028±0.008)
	P ₀	12.7±0.3 ※ ¹ (0.500±0.012)	W ₁	9.0+0.75/−0.5 (0.354+0.039/−0.020)	Unit: mm(inch)	
	P ₁	5.1±0.7 (0.201±0.028)	W ₂	3.0 max. ※ ² (0.118 max.)		

※¹ Accumulated error for 20 pitches is ±2mm.

※² Bonding tape must not protrude from the base tape.

● SB/TB (F: 5mm pitch) (0.197 inches)

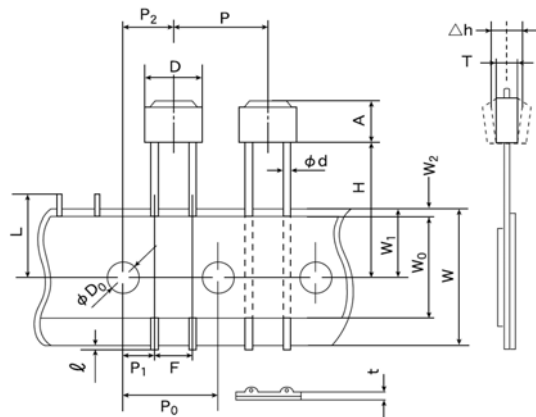

Type	Symbol	Dimensions	Symbol	Dimensions	Symbol	Dimensions
FBR07	A	121: 9.0 max. (0.354 max.)	P ₀	12.7±0.3 ※ ¹ (0.500±0.012)	W ₁	9.0+0.75/−0.5 (0.354+0.039/−0.020)
		850: 7.0 max. (0.276 max.)	P ₁	3.85±0.8 (0.152±0.028)	W ₂	3.0 max. ※ ² (0.118 max.)
	T	2.5 max. (0.098 max.)	P ₂	6.35±1.3 (0.250±0.051)	ℓ	1.0 max. (0.039 max.)
	D	7.5±0.5 (0.925±0.020)	F	5.0+1.0/−0.5 (0.197+0.039/−0.020)	φD ₀	4.0±0.3 (0.157±0.012)
	H	SB: 18.0+2.0/−0 (0.709+0.079/−0)	Δh	0.0±2.0 (0.0±0.079)	φd	0.6±0.05 (0.024±0.002)
		TB: 16.0±0.5 (0.630±0.020)	W	18.0+1.0/−0.5 (0.709+0.039/−0.020)	L	11.0 max. (0.433 max.)
	P	12.7±1.0 (0.500±0.039)	W ₀	12.5 min. (0.492 min.)	t	0.7±0.2 (0.028±0.008)

Unit: mm(inch)

※¹ Accumulated error for 20 pitches is ±2mm.

※² Bonding tape must not protrude from the base tape.

● UB

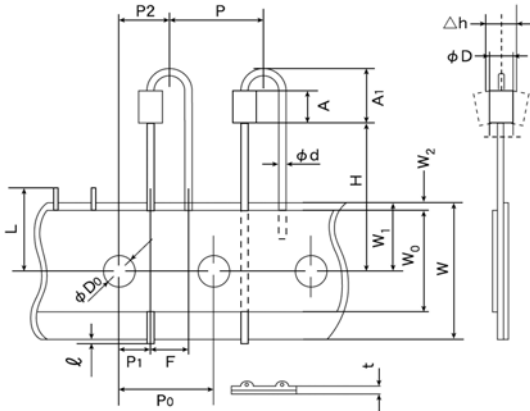

Type	Symbol	Dimensions	Symbol	Dimensions	Symbol	Dimensions
FBA03□450 FBA04□450	A	4.5±0.3 (0.177±0.012)	P ₁	3.85±0.8 (0.152±0.032)	W ₂	3.0 max. ※ ² (0.118 max.)
	A ₁	9.0 max. (0.354 max.)	P ₂	6.35±1.3 (0.250±0.051)	l	1.0 max. (0.039 max.)
	φD	03: 2.5±0.2 (0.098±0.008)	F	5.0±1.0 (0.197±0.039)	φD ₀	4.0±0.3 (0.157±0.012)
		04: 3.5±0.2 (0.138±0.008)	Δh	0.0±2.0 (0.0±0.079)	φd	0.65±0.05 (0.026±0.002)
	H	20.0+0.5/-1.0 (0.787+0.020/-0.039)	W	18.0+1.0/-0.5 (0.709+0.039/-0.020)	L	11.0 max. (0.433 max.)
	P	12.7±1.0 (0.500±0.039)	W ₀	12.5 min. (0.492 min.)	t	0.7±0.2 (0.028±0.008)
P ₀	12.7±0.3 ※ ¹ (0.500±0.012)	W ₁	9.0+0.75/-0.5 (0.354+0.030/-0.020)	Unit: mm (inch)		

※¹ Accumulated error for 20 pitches is ±2mm.

※² Bonding tape must not protrude from the base tape.

● VB 形状

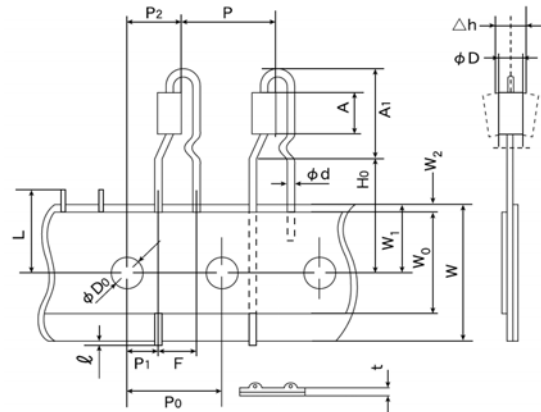

Type	Symbol	Dimensions	Symbol	Dimensions	Symbol	Dimensions
FBA03□450 FBA04□450 FBA04□600 FBA04□900	A	450: 4.5±0.3 (0.177±0.012)	P	12.7±1.0 (0.500±0.039)	W ₁	9.0+0.75/-0.5 (0.354+0.030/-0.020)
		600: 6.0+0.5/-0 (0.236+0.020/-0)	P ₀	12.7±0.3 ※ ¹ (0.500±0.012)	W ₂	3.0 max. ※ ² (0.118 max.)
		900: 9.0±0.5 (0.354±0.020)	P ₁	3.85±0.8 (0.152±0.032)	l	1.0 max. (0.039 max.)
	A ₁	450: 12.5 max. 600: (0.492 max.)	P ₂	6.35±1.3 (0.250±0.051)	φD ₀	4.0±0.3 (0.157±0.012)
		900: 16.0 max. (0.630 max.)	F	5.0±1.0 (0.197±0.039)	φd	0.65±0.05 (0.026±0.002)
		φD	03: 2.5±0.2 (0.098±0.008)	Δh	0.0±2.0 (0.0±0.079)	L
04: 3.5±0.2 (0.138±0.008)	W		18.0+1.0/-0.5 (0.709+0.039/-0.020)	t	0.7±0.2 (0.028±0.008)	
H ₀	16.0±0.5 (0.650±0.020)	W ₀	12.5 min. (0.492 min.)	単位: mm (inch)		

※¹ Accumulated error for 20 pitches is ±2mm.

※² Bonding tape must not protrude from the base tape.

AXIAL LEADED INDUCTORS (CAL Type)、 RADIAL LEADED INDUCTORS (LH Type)、 LEADED FERRITE BEAD INDUCTORS (FB Series A Type/R Type)

RELIABILITY DATA

1. Operating temperature Range		
Specified Value	CAL45 Type	-25 ~ + 105°C
	LHL□□□	
	FBA/FBR	-25 ~ + 85°C
Test Methods and Remarks	CAL45 Type : Including self-generated heat	
	LHL□□□ : Including self-generated heat	

2. Storage temperature Range		
Specified Value	CAL45 Type	-40 ~ + 85°C (Except for taping condition)
	LHL□□□	
	FBA/FBR	

3. Rated current		
Specified Value	CAL45 Type	Within the specified tolerance
	LHL□□□	
	FBA/FBR	
Test Methods and Remarks	CAL45 Type :	The maximum DC value having inductance within 10% and temperature increase within 40°C by the application of DC bias.
	LHL□□□ :	
	FBA/FBR :	No disconnection or appearance abnormality by continuous current application for 30 min. Change after the application shall be within ±20% of the initial value. This is not guaranteed for electrical characteristics during current application.

4. Impedance		
Specified Value	CAL45 Type	Within the specified tolerance
	LHL□□□	
	FBA/FBR	
Test Methods and Remarks	FBA/FBR :	
	Measuring equipment : Impedance analyzer (HP4191A) or its equivalent	
	Measuring frequency : Specified frequency	

5. Inductance		
Specified Value	CAL45 Type	Within the specified tolerance
	LHL□□□	
	FBA/FBR	
Test Methods and Remarks	CAL45 Type :	Measuring equipment : LCR meter (HP4285A + HP42851A or its equivalent) Measuring frequency : Specified frequency
	LHL□□□ :	
	Measuring equipment : LCR meter (HP4285A + HP42851A or its equivalent) : LCR meter (HP4263A) or its equivalent (at 1kHz)	
	Measuring frequency : Specified frequency	

▶ This catalog contains the typical specification only due to the limitation of space. When you consider the purchase of our products, please check our specification.
For details of each product (characteristics graph, reliability information, precautions for use, and so on), see our Web site (<http://www.ty-top.com/>).

6. Q		
Specified Value	CAL45 Type	
	LHL□□□	Within the specified tolerance
	FBA/FBR	
Test Methods and Remarks	LHL□□□ Measuring equipment : LCR meter (HP4285A + HP42851A or its equivalent) : LCR meter (HP4263A) or its equivalent (at 1kHz) Measuring frequency : Specified frequency	

7. DC Resistance		
Specified Value	CAL45 Type	
	LHL□□□	Within the specified tolerance
	FBA/FBR	
Test Methods and Remarks	Measuring equipment : DC ohmmeter	

8. Self resonance frequency		
Specified Value	CAL45 Type	
	LHL□□□	Within the specified tolerance
	FBA/FBR	
Test Methods and Remarks	LHL□□□ Measuring equipment : (HP4191A, 4192A) its equivalent	

9. Temperature characteristic															
Specified Value	CAL45 Type														
	LHL□□□	$\Delta L/L$: Within $\pm 7\%$													
	FBA/FBR														
Test Methods and Remarks	Change of maximum inductance deviation in step 1 to 5														
	<table border="1"> <thead> <tr> <th rowspan="2">Step</th> <th>Temperature (°C)</th> </tr> <tr> <th>LHL□□□</th> </tr> </thead> <tbody> <tr> <td>1</td> <td>20</td> </tr> <tr> <td>2</td> <td>Minimum operating temperature</td> </tr> <tr> <td>3</td> <td>20 (Standard temperature)</td> </tr> <tr> <td>4</td> <td>Maximum operating temperature</td> </tr> <tr> <td>5</td> <td>20</td> </tr> </tbody> </table>	Step	Temperature (°C)	LHL□□□	1	20	2	Minimum operating temperature	3	20 (Standard temperature)	4	Maximum operating temperature	5	20	
Step	Temperature (°C)														
	LHL□□□														
1	20														
2	Minimum operating temperature														
3	20 (Standard temperature)														
4	Maximum operating temperature														
5	20														

10. Tensile strength test																
Specified Value	CAL45 Type															
	LHL□□□	No abnormality such as cut lead, or looseness.														
	FBA/FBR															
Test Methods and Remarks	<p>CAL45 Type : Apply the stated tensile force progressively in the direction to draw terminal.</p> <table border="1"> <thead> <tr> <th>force (N)</th> <th>duration (s)</th> </tr> </thead> <tbody> <tr> <td>10</td> <td>10</td> </tr> </tbody> </table> <p>LHL□□□ : Apply the stated tensile force progressively in the direction to draw terminal.</p> <table border="1"> <thead> <tr> <th>Nominal wire diameter tensile ϕd (mm)</th> <th>force (N)</th> <th>duration (s)</th> </tr> </thead> <tbody> <tr> <td>$0.3 < \phi d \leq 0.5$</td> <td>5</td> <td rowspan="3">30 \pm 5</td> </tr> <tr> <td>$0.5 < \phi d \leq 0.8$</td> <td>10</td> </tr> <tr> <td>$0.8 < \phi d \leq 1.2$</td> <td>25</td> </tr> </tbody> </table> <p>FBA/FBR : The body of a component shall be fixed and a tensile force of 20 \pm 1N shall be applied to the lead wire in the axial direction of the component during 10 \pm 1 seconds.</p>	force (N)	duration (s)	10	10	Nominal wire diameter tensile ϕd (mm)	force (N)	duration (s)	$0.3 < \phi d \leq 0.5$	5	30 \pm 5	$0.5 < \phi d \leq 0.8$	10	$0.8 < \phi d \leq 1.2$	25	
force (N)	duration (s)															
10	10															
Nominal wire diameter tensile ϕd (mm)	force (N)	duration (s)														
$0.3 < \phi d \leq 0.5$	5	30 \pm 5														
$0.5 < \phi d \leq 0.8$	10															
$0.8 < \phi d \leq 1.2$	25															

11. Over current		
Specified Value	CAL45 Type	No emission of smoke no firing.
	LHL□□□	There shall be no scorch or short of wire. LHLC08, LHLC10 : There shall be no firing.
	FBA/FBR	
Test Methods and Remarks	LHL□□□・CAL45 Type : Measuring current : Rated current × 2 Duration : 5 min. Number of measuring : one time	

12. Terminal strength : bending														
Specified Value	CAL45 Type	No abnormality such as cut lead, or looseness.												
	LHL□□□													
	FBA/FBR													
Test Methods and Remarks	CAL45 Type : Suspend a weight of specified mass at the end of the terminals and incline the body through the angle of 90 degrees and return it to the initial position. This operation is done over a period of 2-3 sec. Then second bend in the opposite direction shall be made. Number of bends : Two times.													
	<table border="1"> <thead> <tr> <th>Nominal wire diameter tensile</th> <th>Bending force</th> <th>Mass reference weight</th> </tr> </thead> <tbody> <tr> <td>$0.3 < \phi d \leq 0.5$</td> <td>2.5</td> <td>0.25</td> </tr> <tr> <td>$0.5 < \phi d \leq 0.8$</td> <td>5</td> <td>0.50</td> </tr> </tbody> </table>		Nominal wire diameter tensile	Bending force	Mass reference weight	$0.3 < \phi d \leq 0.5$	2.5	0.25	$0.5 < \phi d \leq 0.8$	5	0.50			
	Nominal wire diameter tensile	Bending force	Mass reference weight											
$0.3 < \phi d \leq 0.5$	2.5	0.25												
$0.5 < \phi d \leq 0.8$	5	0.50												
LHL□□□・FBA/FBR : Suspend a weight of specified mass at the end of the terminals and incline the body through the angle of 90 degrees and return it to the initial position. This operation is done over a period of 2-3 sec. Then second bend in the opposite direction shall be made. Number of bends : Two times.														
<table border="1"> <thead> <tr> <th>Nominal wire diameter tensile</th> <th>Bending force</th> <th>Mass reference weight</th> </tr> </thead> <tbody> <tr> <td>$0.3 < \phi d \leq 0.5$</td> <td>2.5</td> <td>0.25</td> </tr> <tr> <td>$0.5 < \phi d \leq 0.8$</td> <td>5</td> <td>0.5</td> </tr> <tr> <td>$0.8 < \phi d \leq 1.2$</td> <td>10</td> <td>1.0</td> </tr> </tbody> </table>			Nominal wire diameter tensile	Bending force	Mass reference weight	$0.3 < \phi d \leq 0.5$	2.5	0.25	$0.5 < \phi d \leq 0.8$	5	0.5	$0.8 < \phi d \leq 1.2$	10	1.0
Nominal wire diameter tensile	Bending force	Mass reference weight												
$0.3 < \phi d \leq 0.5$	2.5	0.25												
$0.5 < \phi d \leq 0.8$	5	0.5												
$0.8 < \phi d \leq 1.2$	10	1.0												

13. Insulation resistance : between the terminals and body		
Specified Value	CAL45 Type	100M Ω min.
	LHL□□□	
	FBA/FBR	
Test Methods and Remarks	LHL□□□ : Applied voltage : 500 VDC Duration : 60 sec.	

14. Insulation resistance : between terminals and core		
Specified Value	CAL45 Type	1M Ω min.
	LHL□□□	
	FBA/FBR	
Test Methods and Remarks	FBA/FBR : Applied voltage : 100 VDC Duration : 60±5 sec.	

15. Withstanding : between the terminals and body		
Specified Value	CAL45 Type	No abnormality such as insulation damage
	LHL□□□	
	FBA/FBR	
Test Methods and Remarks	LHL□□□ : According to JIS C5102. 7. 1. 3 (C) Metal global method Applied voltage : 500 VDC Duration : 60 sec.	

▶ This catalog contains the typical specification only due to the limitation of space. When you consider the purchase of our products, please check our specification. For details of each product (characteristics graph, reliability information, precautions for use, and so on), see our Web site (<http://www.ty-top.com/>).

16. DC bias characteristic		
Specified Value	CAL45 Type	$\Delta L/L$: Within -10%
	LHL□□□	
	FBA/FBR	
Test Methods and Remarks	CAL45 Type : Measure inductance with application of rated current using LCR meter to compare it with the initial value.	

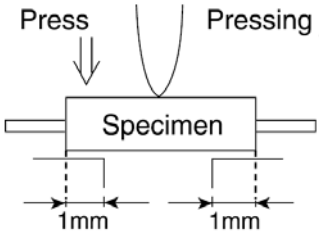
17. Body strength		
Specified Value	CAL45 Type	No abnormality as damage.
	LHL□□□	
	FBA/FBR	No abnormality such as cracks on body.
Test Methods and Remarks	<p>CAL45 Type :</p> <p>Applied force : 50N Duration : 10 sec. Speed : Shall attain to specified force in 2 sec.</p> <p>FBA :</p> <p>Applied force : 50 ± 3N Duration : 30 ± 1 sec.</p> 	

18. Resistance to vibration		
Specified Value	CAL45 Type	$\Delta L/L$: Within $\pm 5\%$
	LHL□□□	Appearance : No abnormality $\Delta L/L$: Within $\pm 5\%$ Q change : Within $\pm 30\%$
	FBA/FBR	Appearance : No abnormality Impedance change : Within $\pm 20\%$
Test Methods and Remarks	<p>CAL45 Type :</p> <p>Directions : 2 hrs each in X, Y and Z directions total : 6hrs. Frequency range : 10 to 55 to 10Hz (1min.) Amplitude : 1.5mm Mounting method : Soldering onto printed board. Recovery : At least 1hr of recovery under the standard condition after the test, followed by the measurement within 2hrs.</p> <p>LHL□□□ • FBA/FBR :</p> <p>Directions : 2 hrs each in X, Y and Z directions total : 6hrs. Frequency range : 10 to 55 to 10Hz (1min.) Amplitude : 1.5mm Mounting method : Soldering onto printed board.</p>	

19. Resistance to shock		
Specified Value	CAL45 Type	No significant abnormality in appearance
	LHL□□□	
	FBA/FBR	
Test Methods and Remarks	<p>CAL45 Type :</p> <p>Drop test</p> <p>Impact material : concrete or vinyl tile Height : 1m Total number of drops : 10 times</p>	

20. Solderability		
Specified Value	CAL45 Type	At least 75% of terminal electrode is covered by new solder.
	LHL□□□	At least 75% of terminal electrode is covered by new solder.
	FBA/FBR	At least 90% of terminal electrode is covered by new solder.
Test Methods and Remarks	CAL45 Type : Solder temperature : 230±5°C Duration : 2±0.5 sec. LHL□□□ : Solder temperature : 235±5°C Duration : 2±0.5 sec. Immersion depth : Up to 1.5mm from bottom of case. FBA/FBR : Solder temperature : 230±5°C Duration : 3±1 sec. Immersion depth : Up to 1.5mm from terminal root.	

21. Resistance to soldering heat		
Specified Value	CAL45 Type	ΔL/L : Within ±5%
	LHL□□□	No significant abnormality in appearance Inductance change : Within ±5% Q change : Within ±30%
	FBA/FBR	No significant abnormality in appearance Impedance change : Within ±20%
Test Methods and Remarks	CAL45 Type : Solder temperature : 270±5°C Duration : 5±0.5 sec. One time Immersed conditions : Inserted into substrate with t=1.6mm Recovery : At least 1hr of recovery under the standard condition after the test, followed by the measurement within 2hrs. LHL□□□ : Solder bath method : Solder temperature : 260±5°C Duration : 10±1 sec. : Up to 1.5mm from the bottom of case. Manual soldering : Solder temperature : 350±10°C (At the tip of soldering iron) Duration : 5±1 sec. : Up to 1.5mm from the bottom of case. Caution : No excessive pressing shall be applied to terminals. Recovery : 1 to 2hrs of recovery under the standard condition after the test. FBA/FBR : Solder bath method: Condition 1 : Solder temperature : 260±5°C Duration : 10±1 sec. Immersion depth : Up to 1.5mm from the terminal root. Condition 2 : Solder temperature : 350±5°C Duration : 3±1 sec. Immersion depth : Up to 1.5mm from the terminal root. Recovery : 3hrs of recovery under the standard condition after the test.	

22. Resistance to solvent		
Specified Value	CAL45 Type	Please avoid the ultrasonic cleaning of this product.
	LHL□□□	
	FBA/FBR	No significant abnormality in appearance Impedance change : Within ±20%
Test Methods and Remarks	FBA/FBR : Solvent temperature : 20~25°C Duration : 30±5 sec. Solvent type : Acetone Recovery : 3hrs of recovery under the standard condition after the test.	

▶ This catalog contains the typical specification only due to the limitation of space. When you consider the purchase of our products, please check our specification. For details of each product (characteristics graph, reliability information, precautions for use, and so on), see our Web site (<http://www.ty-top.com/>).

23. Thermal shock																	
Specified Value	CAL45 Type	$\Delta L/L$: Within $\pm 10\%$															
	LHL□□□	Appearance : No abnormality Inductance change : Within $\pm 10\%$ Q change : Within $\pm 30\%$															
	FBA/FBR	Appearance : No abnormality Impedance change : Within $\pm 20\%$															
Test Methods and Remarks	CAL45 Type: Conditions for 1 cycle																
	<table border="1"> <thead> <tr> <th>Step</th> <th>Temperature (°C)</th> <th>Duration (min.)</th> </tr> </thead> <tbody> <tr> <td>1</td> <td>$-25+0/-3$</td> <td>30 ± 3</td> </tr> <tr> <td>2</td> <td>Room temperature</td> <td>Within 3</td> </tr> <tr> <td>3</td> <td>$+85+2/-0$</td> <td>30 ± 3</td> </tr> <tr> <td>4</td> <td>Room temperature</td> <td>Within 3</td> </tr> </tbody> </table>	Step	Temperature (°C)	Duration (min.)	1	$-25+0/-3$	30 ± 3	2	Room temperature	Within 3	3	$+85+2/-0$	30 ± 3	4	Room temperature	Within 3	
	Step	Temperature (°C)	Duration (min.)														
	1	$-25+0/-3$	30 ± 3														
	2	Room temperature	Within 3														
	3	$+85+2/-0$	30 ± 3														
4	Room temperature	Within 3															
Number of cycles : 5 cycles																	
Recovery : At least 1hr of recovery under the standard condition after the removal from test chamber, followed by the measurement within 2hrs.																	
LHL□□□•FBA/FBR: According to JIS C0025																	
Conditions for 1 cycle																	
<table border="1"> <thead> <tr> <th>Step</th> <th>Temperature (°C)</th> <th>Duration (min.)</th> </tr> </thead> <tbody> <tr> <td>1</td> <td>Minimum operating temperature</td> <td>30 ± 3</td> </tr> <tr> <td>2</td> <td>Room temperature</td> <td>Within 3</td> </tr> <tr> <td>3</td> <td>Maximum operating temperature</td> <td>30 ± 3</td> </tr> <tr> <td>4</td> <td>Room temperature</td> <td>Within 3</td> </tr> </tbody> </table>	Step	Temperature (°C)	Duration (min.)	1	Minimum operating temperature	30 ± 3	2	Room temperature	Within 3	3	Maximum operating temperature	30 ± 3	4	Room temperature	Within 3		
Step	Temperature (°C)	Duration (min.)															
1	Minimum operating temperature	30 ± 3															
2	Room temperature	Within 3															
3	Maximum operating temperature	30 ± 3															
4	Room temperature	Within 3															
Number of cycles : 10 cycles [LHL□□□]																	
Recovery : 5 cycles (FBA/ FBR)																	
: 1 to 2hrs of recovery under the standard condition after the removal from the test chamber. [LHL□□□]																	
: 3hrs of recovery under the standard condition after the removal from the test chamber. (FBA/ FBR)																	

24. Damp heat		
Specified Value	CAL45 Type	$\Delta L/L$: Within $\pm 10\%$
	LHL□□□	
	FBA/FBR	Appearance : No abnormality Impedance change : Within $\pm 20\%$
Test Methods and Remarks	CAL45 Type :	
	Temperature	: $40\pm 2^\circ\text{C}$
	Humidity	: 90~95%RH
	Duration	: 1000 hrs
	Recovery	: At least 1hr of recovery under the standard removal from test chamber, followed by the measurement within 2hrs.
	FBA/FBR :	
Temperature	: $60\pm 2^\circ\text{C}$	
Humidity	: 90~95%RH	
Duration	: 1000 hrs	
Recovery	: 3hrs of recovery under the standard condition after the removal from the test chamber.	

25. Loading under damp heat		
Specified Value	CAL45 Type	$\Delta L/L$: Within $\pm 10\%$
	LHL□□□	Appearance : No abnormality Inductance change : Within $\pm 10\%$ Q change : Within $\pm 30\%$
	FBA/FBR	
Test Methods and Remarks	CAL45 Type : Temperature : $40 \pm 2^\circ\text{C}$ Humidity : $90 \sim 95\%RH$ Duration : 1000 hrs Applied current : Rated current Recovery : At least 1hr of recovery under the standard removal from test chamber, followed by the measurement within 2hrs. LHL□□□ : Temperature : $40 \pm 2^\circ\text{C}$ Humidity : $90 \sim 95\%RH$ Duration : $1000 + 48 / -0$ hrs Applied current : Rated current Recovery : 1 to 2hrs of recovery under the standard condition after the removal from the test chamber.	
26. Loading at high temperature		
Specified Value	CAL45 Type	$\Delta L/L$: Within $\pm 10\%$
	LHL□□□	
	FBA/FBR	
Test Methods and Remarks	CAL45 Type : Temperature : $85 \pm 2^\circ\text{C}$ Duration : 1000 hrs Applied current : Rated current Recovery : At least 1hr of recovery under the standard removal from test chamber, followed by the measurement within 2hrs.	
27. Low temperature life test		
Specified Value	CAL45 Type	$\Delta L/L$: Within $\pm 10\%$
	LHL□□□	Appearance : No abnormality Inductance change : Within $\pm 10\%$ Q change : Within $\pm 30\%$
	FBA/FBR	
Test Methods and Remarks	CAL45 Type : Temperature : $-25 \pm 2^\circ\text{C}$ Duration : 1000 hrs Recovery : At least 1hr of recovery under the standard removal from test chamber, followed by the measurement within 2hrs. LHL□□□ : Temperature : $-40 \pm 3^\circ\text{C}$ Duration : $1000 + 48 / -0$ hrs Recovery : 1 to 2hrs of recovery under the standard condition after the removal from the test chamber.	
28. High temperature life test		
Specified Value	CAL45 Type	
	LHL□□□	Appearance : No abnormality Inductance change : Within $\pm 10\%$ Q change : Within $\pm 30\%$
	FBA/FBR	
Test Methods and Remarks	LHL□□□ : Temperature : $105 \pm 2^\circ\text{C}$ Duration : $1000 + 48 / -0$ hrs Recovery : 1 to 2hrs of recovery under the standard condition after the removal from the test chamber.	

▶ This catalog contains the typical specification only due to the limitation of space. When you consider the purchase of our products, please check our specification.
 For details of each product (characteristics graph, reliability information, precautions for use, and so on), see our Web site (<http://www.ty-top.com/>).

AXIAL LEADED INDUCTORS (CAL Type)、 RADIAL LEADED INDUCTORS (LH Type)、 LEADED FERRITE BEAD INDUCTORS (FB Series A Type/R Type)

■ PRECAUTIONS

1. Circuit Design	
Precautions	<p>◆Operating environment</p> <p>1. The products described in this specification are intended for use in general electronic equipment,(office supply equipment, telecommunications systems, measuring equipment, and household equipment). They are not intended for use in mission-critical equipment or systems requiring special quality and high reliability (traffic systems, safety equipment, aerospace systems, nuclear control systems and medical equipment including life-support systems,) where product failure might result in loss of life, injury or damage. For such uses, contact TAIYO YUDEN Sales Department in advance.</p>
2. PCB Design	
Precautions	<p>◆Design</p> <p>1. Please design insertion pitches as matching to that of leads of the component on PCBs.</p>
Technical considerations	<p>◆Design</p> <p>1. When Inductors are mounted onto a PC board, hole dimensions on the board should match the lead pitch of the component, if not, it will cause breakage of the terminals or cracking of terminal roots covered with resin as excess stress travels through the terminal legs.</p>
3. Considerations for automatic placement	
Precautions	<p>◆Adjustment of mounting machine</p> <p>1. Excessive impact load should not be imposed on the products when mounting onto the PC boards. 2. Mounting and soldering conditions should be checked beforehand.</p>
Technical considerations	<p>◆Adjustment of mounting machine</p> <p>1. When installing products, care should be taken not to apply distortion stress as it may deform the products.</p>
4. Soldering	
Precautions	<p>◆Wave soldering</p> <p>1. Please refer to the specifications in the catalog for a wave soldering. 2. Do not immerse the entire inductor in the flux during the soldering operation.</p> <p>◆Lead free soldering</p> <p>1. When using products with lead free soldering, we request to use them after confirming adhesion, temperature of resistance to soldering heat, soldering etc sufficiently.</p> <p>◆Recommended conditions for using a soldering iron:</p> <ul style="list-style-type: none"> •Put the soldering iron on the land-pattern. •Soldering iron's temperature – Below 350°C •Duration – 3 seconds or less •The soldering iron should not directly touch the inductor. <p>◆Reflow soldering</p> <p>1. As for reflow soldering, please contact our sales staff.</p>
Technical considerations	<p>◆Lead free soldering</p> <p>1. If products are used beyond the range of the recommended conditions, heat stresses may deform the products, and consequently degrade the reliability of the products.</p> <p>◆Recommended conditions for using a soldering iron</p> <p>If products are used beyond the range of the recommended conditions, heat stresses may deform the products, and consequently degrade the reliability of the products.</p>
5. Cleaning	
Precautions	<p>◆Cleaning conditions</p> <p>1. CAL type, LH type Please do not do cleaning by a supersonic wave.</p>
Technical considerations	<p>◆Cleaning conditions</p> <p>1. CAL type, LH type, If washing by supersonic waves, supersonic waves may deform products.</p>

▶ This catalog contains the typical specification only due to the limitation of space. When you consider the purchase of our products, please check our specification. For details of each product (characteristics graph, reliability information, precautions for use, and so on), see our Web site (<http://www.ty-top.com/>).

6. Handling	
Precautions	<ul style="list-style-type: none"> ◆ Handling <ol style="list-style-type: none"> 1. Keep the inductors away from all magnets and magnetic objects. ◆ Mechanical considerations <ol style="list-style-type: none"> 1. Please do not give the inductors any excessive mechanical shocks. 2. LH type <ul style="list-style-type: none"> If inductors are dropped onto the floor or a hard surface they should not be used. ◆ Packing <ol style="list-style-type: none"> 1. Please do not give the inductors any excessive mechanical shocks. <ul style="list-style-type: none"> In loading, please pay attention to handling indication mentioned in a packing box (a loading direction / number of maximum loading / fragile item).
Technical considerations	<ul style="list-style-type: none"> ◆ Handling <ol style="list-style-type: none"> 1. There is a case that a characteristic varies with magnetic influence. ◆ Mechanical considerations <ol style="list-style-type: none"> 1. There is a case to be damaged by a mechanical shock. 2. LH type <ul style="list-style-type: none"> There is a case to be broken by a fall. ◆ Packing <ol style="list-style-type: none"> 1. There is a case that a lead wire could be deformed by a fall or an excessive shock.
7. Storage conditions	
Precautions	<ul style="list-style-type: none"> ◆ Storage <ol style="list-style-type: none"> 1. To maintain the solderability of terminal electrodes and to keep the packing material in good condition, temperature and humidity in the storage area should be controlled. <ul style="list-style-type: none"> Recommended conditions • Ambient temperature 0~40°C • Humidity Below 70% RH <p>The ambient temperature must be kept below 30°C. Even under ideal storage conditions, solderability of products electrodes may decrease as time passes.</p> <p>For this reason, inductors should be used within one year from the time of delivery.</p> <p>In case of storage over 6 months, solderability shall be checked before actual usage.</p>
Technical considerations	<ul style="list-style-type: none"> ◆ Storage <ol style="list-style-type: none"> 1. Under a high temperature and humidity environment, problems such as reduced solderability caused by oxidation of terminal electrodes and deterioration of taping/packaging materials may take place.