



贝特卫士®

更好的电路安全卫士!
You build electronics, We safeguard them!

承 认 书

APPROVAL SHEET

编号 No.	9321315278-C/2-B
日期 Date	2019.01.11

客 户 Customer	
-----------------	--

品 名 Product	Time-Lag subminiature fuse
系 列 Series	932 series

料号 Part No.	规格描述 Specification	备注 Remark
贝特电子 Betterfuse		
客 户 Customer		

环保特别提示 Special instructions for environmental protection
本产品:

供应商-贝特电子 Supplier-Betterfuse	零件承认章 Approval Signet	客 户 Customer	零件承认章 Approval Signet
制 作 Make			
审 核 Check			
确 认 Approval			

联络 Contact			
业务 Sales	电话 Telephone	手机 Cellphone	邮箱 E-mail
零件承认后敬请回签一份给我司留存, 或将承认后的封面传真(0769-8352 1857)至我司, 谢谢!			

Document Record						
No.	Date	Modified Content	Page	Edition	Prepared/modified by	Checked by
1	2014.02.14	Draft	6	D	Runsong Zhong	Lianghua Guo
2	2014.04.08	Added TUV certification	6	B/0	Kings Luo	Wenhua Yan
3	2015.02.04	Add 125mA and 250mA CQC certification; Add 200mA I-T Curve	4,15,16	B/1	Kings Luo	Wenhua Yan
4	2015.02.09	Add 8A and 10A CQC certification;	19,20	B/2	Kings Luo	Wenhua Yan
5	2015.06.18	The fuse high to change the 7.6mm	5	B/3	Jeffery	Gem Guo
6	2015.08.04	Update UR certification		B/4	Jeffery	Gem Guo
7	2015.09.09	Update CQC , TUV certification		B/5	Jeffery	Gem Guo
8	2015.11.18	Update the tapping	9	B/6	Jeffery	Lin Gao
9	2015.12.12	Update PSE certification		B/7	Jeffery	Lin Gao
10	2016.01.14	Update I2T value		B/8	Jeffery	Wenhua Yan
11	2016.04.15	Add the 0.16A~0.4A CQC certification	3,7	B/9	Jeffery	Helge
12	2016.8.24	Change the construction		B/10	Jeffery	Wenqiang Luo
13	2017.12.08	Update BSI, SEMKO certification		C/0	J.Q.	Fei Gao
14	2018.03.05	Update TUV certification		C/1	J.Q.	Fei Gao
15	2018.10.08	Change of the innor core and material no	4	C/2	Xiang Xiong	Fei Gao

TABLE OF CONTENTS

1. SCOPE AND DESCRIPTION.....	3
2. GENERAL INFORMATION.....	3
3. AGENCY APPROVALS.....	3
4. PART NUMBERING SYSTEM.....	4
5. CONSTRUCTION AND MECHANICAL CHARACTERISTICS.....	5
6. ELECTRICAL SPECIFICATIONS.....	6
7. SOLDERING PARAMETERS.....	8
8. ORDERING INFORMATION.....	8
9. PACKING INFORMATION.....	9
10.APPENDIX.....	10

1. SCOPE AND DESCRIPTION

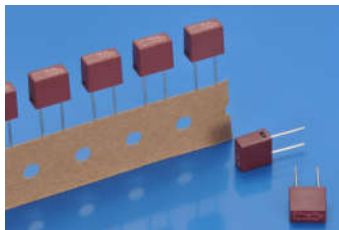

Following electronic product specifications apply to fuses of the 932 series. The 932 series is a time lag type subminiature fuse for over-current protection.

Its main applications are for consumer electronics, LED drivers, power supplies, battery chargers and controllers for industrial use.

2. GENERAL INFORMATION





General Description



The 932 series provides protection for printed circuit boards used in a large variety of applications that need fuses with time-delay, low breaking capacity. The sub-miniature device is constructed of a plastic cap and base with a tin plated copper lead wire. It offers excellent mounting characteristics and is 100% tested for cold resistance.

Detailed Features

- Subminiature fuse with time delay, low breaking capacity
- Small, rectangular and leaded design minimizes board space and eliminates the need for additional mounting components
- Plastic cap / brown thermoplastic fuse body.
- 0.6mm lead wires made of tin plated copper.
- Protection against harmful over-currents in primary and secondary applications.
- Lead-free, Halogen-free, RoHS compliant
- Designed according to IEC 60127-3
- TUV compliance to EN 60127-7: 2016

3. AGENCY APPROVALS

Agency	Agency File Number	Voltage/ Current Rating
	E300003	300/250/125V AC: 0.1A~6.3A;
	CQC11012062690 CQC13012097386 CQC15012121655 CQC16012141544	250VAC: 125mA, 160mA, 200mA, 250mA, 315mA, 400mA, 500mA, 630mA, 800mA, 1A, 1.25A, 1.6A, 2A, 2.5A, 3.15A, 4A, 5A, 6.3A, 8A, 10A
	PSE15020937	250V AC: 1A, 1.25A, 1.6A, 2A, 2.5A, 3.15A, 4A, 5A
	40033369	250V AC: 630mA, 800mA, 1A, 1.25A, 1.6A, 2A, 2.5A, 3.15A, 4A, 5A, 6.3A
	SU05042-13003, SU05042-13002, SU05042-13001	250V AC: 500mA, 630mA, 800mA, 1A, 1.25A, 1.6A, 2A, 2.5A, 3.15A, 4A, 5A, 6.3A

	R 50279350	300V AC: 125mA, 160mA,200mA, 250mA, 315mA, 400mA, 500mA, 630mA, 800mA, 1A, 1.25A, 1.6A, 2A, 2.5A, 3.15A, 4A, 5A, 6.3A, 8A, 10A 250V AC: 125mA, 160mA,200mA, 250mA, 315mA, 400mA, 500mA,
	KM 677189	250V AC:3.15A;5A;8A;10A
	1719061	250V AC:3.15A;5A;8A;10A

4. PART NUMBERING SYSTEM

4.1 Part Number

Example: 9321315278

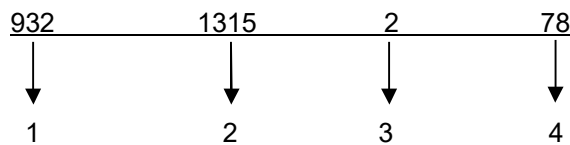

- 1.Product Series
- 2.Ampere Rating
- 3.Rated Voltage

- 4.Supplementary Code

- 932
- 3.15A (see table 4.2 below)
- 1– 125V
- 2–250V
- 3–300V
- Complement Code(see table 4.2 below)

4.2. Ampere / Voltage Rating Table

AMP CODE	CURRENT RATING	VOLTAGE RATING
0100	100mA	125 / 250 / 300V AC
0125	125mA	125 / 250 / 300V AC
0160	160mA	125 / 250 / 300V AC
0200	200mA	125 / 250 / 300V AC
0250	250mA	125 / 250 / 300V AC
0315	315mA	125 / 250 / 300V AC
0400	400mA	125 / 250 / 300V AC
0500	500mA	125 / 250 / 300V AC
0630	630mA	125 / 250 / 300V AC
0800	800mA	125 / 250 / 300V AC
1100	1.00A	125 / 250 / 300V AC
1125	1.25A	125 / 250 / 300V AC
1160	1.60A	125 / 250 / 300V AC
1200	2.00A	125 / 250 / 300V AC
1250	2.50A	125 / 250 / 300V AC
1315	3.15A	125 / 250 / 300V AC
1400	4.00A	125 / 250 / 300V AC
1500	5.00A	125 / 250 / 300V AC
1630	6.30A	125 / 250 / 300V AC
1800	8.00A	125 / 250 / 300V AC
2100	10.00A	125 / 250 / 300V AC

4.3.Supplementary Code

CODE	DESIGNATION
02	Bulk packing
03	Leads:4.3±0.3mm
04	Leads:7±1mm
05	Leads:3.5±0.5mm
06	Leads:4±1mm
⋮	
78	Taping
79	Cut short the leads(leads:2.5±0.3mm)

5. CONSTRUCTION AND MECHANICAL CHARACTERISTICS

Construction (cross section)

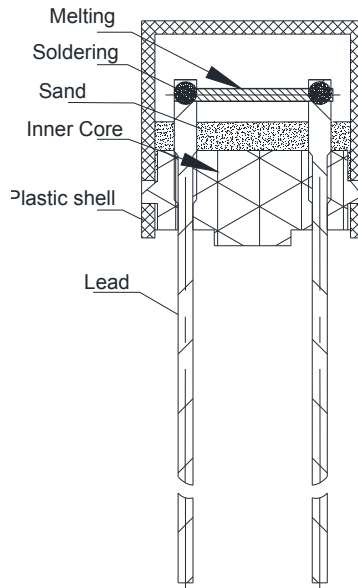

Dimensions (units: mm)

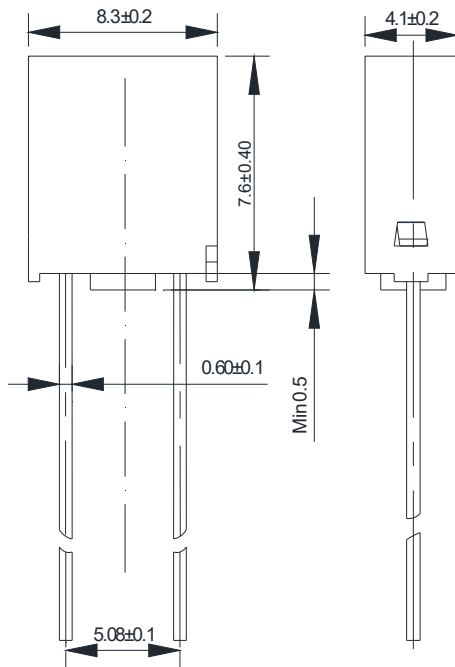

Operating Temperature:

-55°C to +125°C

Storage Conditions:

+10°C to +60°C

Relative humidity: ≤ 75% yearly average
without dew, maximum 30 days at 95%

Vibration Resistance:

24 cycles at 15 min. each (60068-6)

10-60Hz at 0.75mm amplitude

60-2000Hz at 10g acceleration

Long Leads: L=18.8±1.5mm

Short Leads: L=4.3±0.3mm

6. ELECTRICAL SPECIFICATIONS

Time vs Current Characteristics Table

(measured with constant current power supply)

Time vs Current Characteristics: IEC 60127-3/IV

Rated Current	150%	210%	275%	400%	1000%
100mA~10.0A	>1h	<2min	400ms-10s	150ms-3s	20ms-150ms

Average Time Current (I-T Curves)

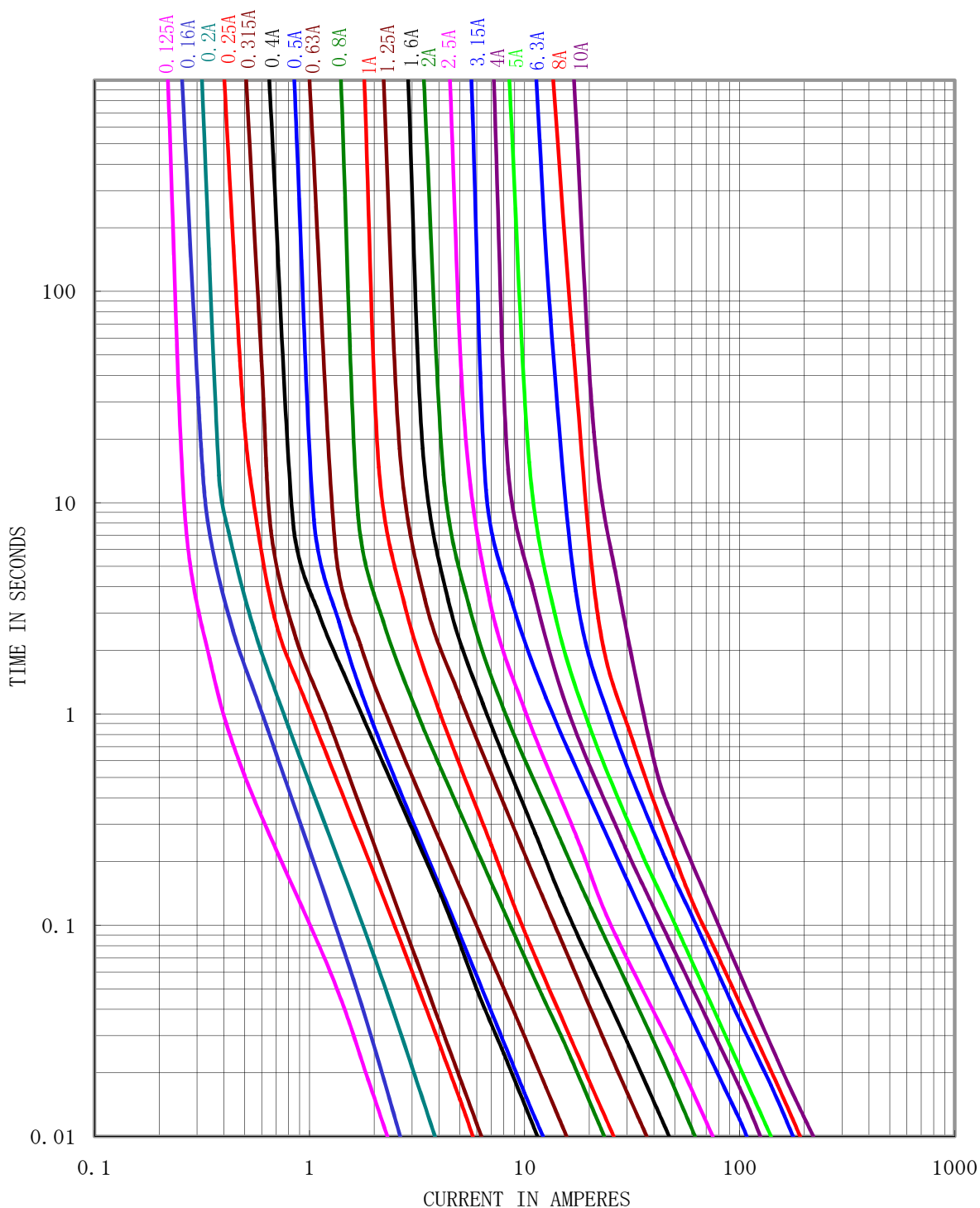

Electrical Characteristics															
Amp Code	Rated Current	Max. Voltage	Max. Voltage Drop(mV)	Max. Power Dissipation (mW)	Nominal Melting I ² t(A ² sec)	Breaking Capacity	Approvals								
							cURus	VDE	CQC	PSE	KC	TUV (250V)	TUV (300V)	BSI	SEMKO
0100	100mA	300V AC	350	170	0.034	100A@125V AC 100A@250V AC 50A or 10In@300V AC	●	○	○	○	○	○	○	○	
0125	125mA		300	180	0.053		●	○	●	○	○	●	●	○	○
0160	160mA		280	190	0.073		●	○	●	○	○	●	●	○	○
0200	200mA		260	200	0.141		●	○	●	○	○	●	●	○	○
0250	250mA		240	220	0.331		●	○	●	○	○	●	●	○	○
0315	315mA		220	250	0.348		●	○	●	○	○	●	●	○	○
0400	400mA		200	280	1.32		●	○	●	○	○	●	●	○	○
0500	500mA		190	310	1.49		●	○	●	○	○	●	●	○	○
0630	630mA		180	360	2.46		●	●	●	○	●	○	●	○	○
0800	800mA		160	430	5.52		●	●	●	○	●	○	●	○	○
1100	1.00A		140	500	6.70		●	●	●	●	●	○	●	○	○
1125	1.25A		130	600	13.0		●	●	●	●	●	○	●	○	○
1160	1.60A		120	730	22.0		●	●	●	●	●	○	●	○	○
1200	2.00A		100	870	38.0		●	●	●	●	●	○	●	○	○
1250	2.50A		100	1000	56		●	●	●	●	●	○	●	○	○
1315	3.15A		100	1200	101		●	●	●	●	●	○	●	●	●
1400	4.00A		100	1400	156		●	●	●	●	●	○	●	○	○
1500	5.00A		100	1400	200		●	●	●	●	●	○	●	●	●
1630	6.30A		100	1400	260		●	●	●	○	●	○	●	○	○
1800	8.00A		100	1400	380		○	○	●	○	○	○	●	●	●
2100	10.00A		100	1400	480		○	○	●	○	○	○	●	●	●

- Notes:**
1. Permissible continuous operating current is ≤100% at ambient temperature of 23°C (73.4°F)
 2. For certification, the cURus by 125/250/300V, the TUV by 250/300V, the others by 250V.
 3. The current values used for calculating I²t should be within the standard range of 8ms ~ 10ms.

Temperature Derating Curve

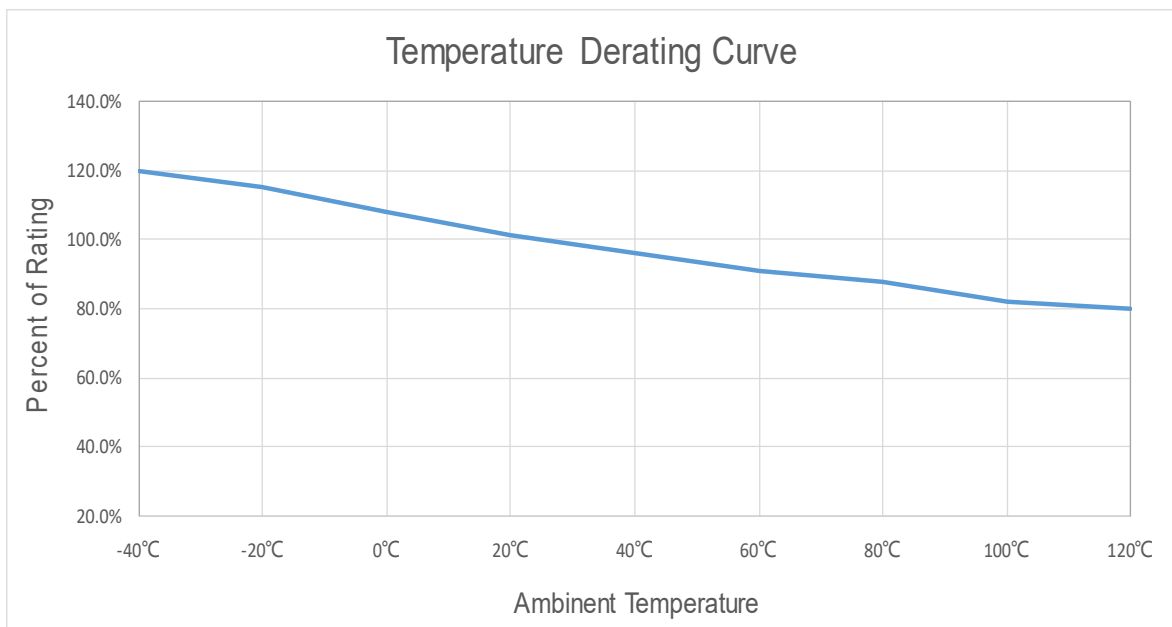

$$\text{Calculation for ideal fuse selection} = \frac{\text{Operating Current (A)}}{\text{Rating (\%} \times 0.75)}$$

7. SOLDERING PARAMETERS

260±5°C .≤5 sec (Wave Soldering)

350°C .≤3 sec (Hand Soldering)

Soldering Peak:

260±5°C - 10 sec (IEC 60068-20)

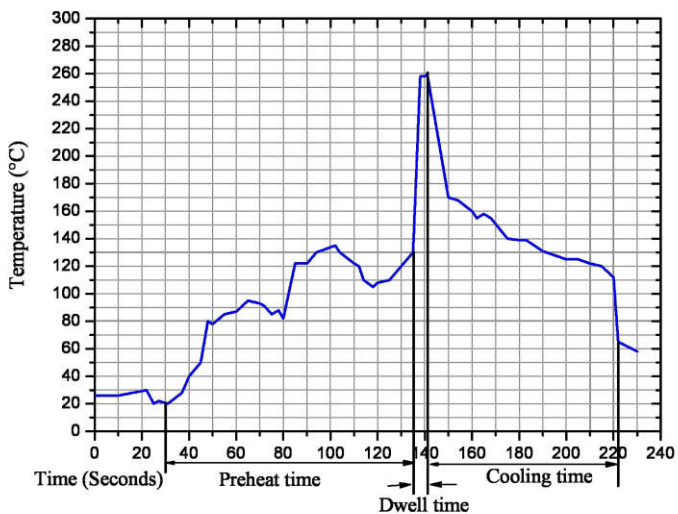

8. ORDERING INFORMATION

The following information are necessary in order to place your order with us correctly:

Series	Amp Code	Supplementary Code	Qty
932			

8. PACKING INFORMATION

Taping detail

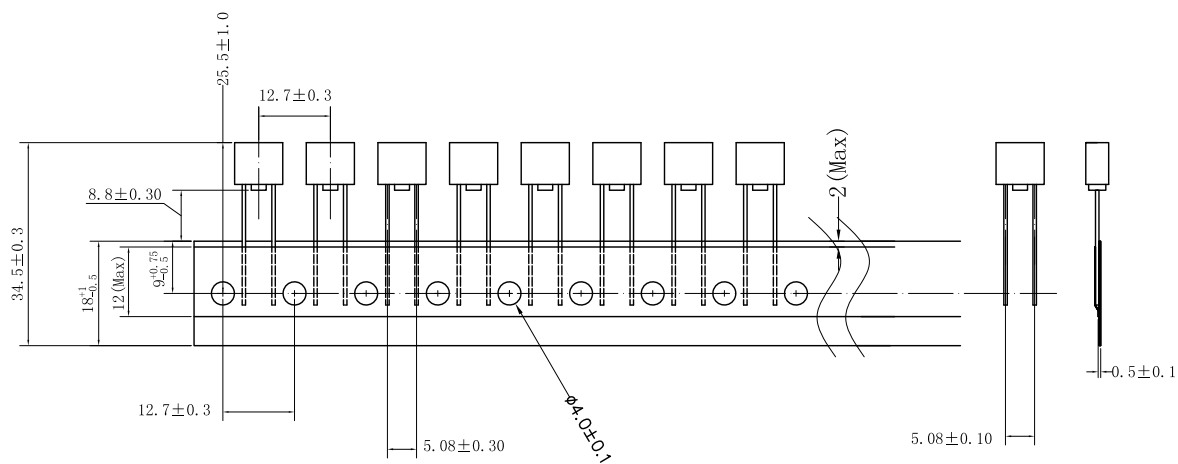

Inner Packaging Box

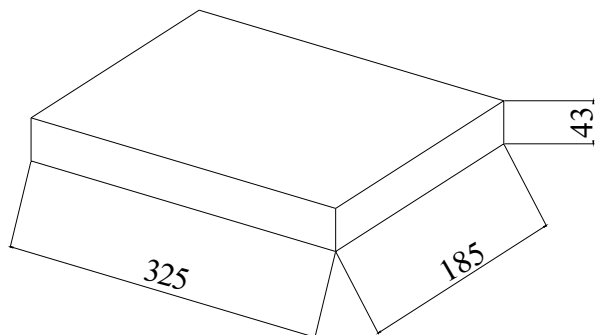

Master Carton

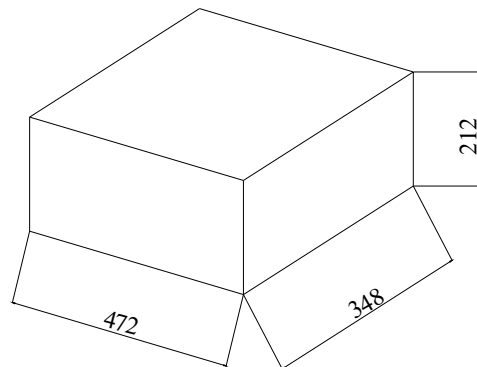

Net Weight (1000pcs+Taping)	0.54Kg	Master Carton Weight	6.10Kg
Qty Per Box	1000pcs	Qty Per Carton	10000pcs

© Dongguan Better Electronics Technology Co.,Ltd.

东莞市贝特电子科技股份有限公司

Room 601 of 16 Block, Xinzhu Yuan, No.4, Xinzhu Road, Songshanlake Hightech Industrial Development Zone, Dongguan City, Guangdong P.R.C
 中国广东省东莞市松山湖国家高新技术产业开发区新竹路4号新竹苑16座办公601

Tel: +86 769-2307 8212 Fax: +86 769-8352 1857

Web: www.betterfuse.com

Email: info@betterfuse.com

9. APPENDIX



ONLINE CERTIFICATIONS DIRECTORY

JDYX2.E300003 Fuses, Supplemental - Component

[Page Bottom](#)

Fuses, Supplemental - Component

[See General Information for Fuses, Supplemental - Component](#)

DONGGUAN BETTER ELECTRONICS TECHNOLOGY CO LTD
 RM 601 OF 16 BLK
 XINZHUYUAN NO 4 XINZHU RD
 SONGSHANLAKE HIGHTECH INDUSTRIAL DEVELOPMENT ZONE
 DONGGUAN, GUANGDONG 523808 CHINA

E300003

Supplemental micro fuses: pigtail leads

Cat. No.	Size mm(in)	Amps (A)	Volts (V)	Interrupting Rating (A)
212	7.2 x 3.0 (0.28 x 0.12)	3 - 6.3	125Vac	35
		3 - 6.3	250Vac	35
932	8.5 x 4.0 (0.33 x 0.16)	0.1 - 0.4	125Vac	100
		0.1 - 0.4	250Vac	100
		0.1 - 0.4	300Vac	50
		0.5 - 6.3	125Vac	100
		0.5 - 6.3	250Vac	100
		0.5 - 6.3	300Vac	50

Supplemental micro fuses: surface mount

Cat. No.	Size mm(in)	Amps (A)	Volts (V)	Interrupting Rating (A)
065, 066, 062, 064, 067 or 068, followed by ampere 0-8.				
	1.6 x 0.81 x 0.65 (0.06 x 0.03 x 0.03)	0.1 - 1.5	63Vdc	50
		0.1 - 8	32Vdc	50

Marking: Company name and model designation.

Last Updated on 2016-03-28

[Questions?](#)

[Print this page](#)

[Terms of Use](#)

[Page Top](#)

◆ 2016 UL LLC

The appearance of a company's name or product in this database does not in itself assure that products so identified have been manufactured under UL's Follow-Up Service. Only those products bearing the UL Mark should be considered to be Certified and covered under UL's Follow-Up Service. Always look for the Mark on the product.

UL permits the reproduction of the material contained in the Online Certification Directory subject to the following conditions: 1. The Guide Information, Assemblies, Constructions, Designs, Systems, and/or Certifications (files) must be presented in their entirety and in a non-misleading manner, without any manipulation of the data (or drawings). 2. The statement "Reprinted from the Online Certifications Directory with permission from UL" must appear adjacent to the extracted material. In addition, the reprinted material must include a copyright notice in the following format: "© 2016 UL LLC".



产品认证证书

证书编号: CQC13012097386

申请人名称及地址

东莞市贝特电子科技股份有限公司
东莞市松山湖高新技术产业开发区新竹路4号新竹苑16座办公601

制造商名称及地址

东莞市贝特电子科技股份有限公司
东莞市松山湖高新技术产业开发区新竹路4号新竹苑16座办公601

生产企业名称及地址

东莞市贝特电子科技股份有限公司 (V003591)
东莞市寮步镇横坑南门村第二工业区C座、B座

产品名称和系列、规格、型号

超小型熔断体

932 T125mAL250V、932 T250mAL250V

产品标准和技术要求

GB9364.1-1997 GB9364.3-1997 CQC11-462125-2009附件2

认证模式

产品型式试验+初次工厂检查+获证后监督

上述产品符合CQC11-462125-2009认证规则的要求,特发此证。

发证日期: 2015年08月24日

证书有效期内本证书的有效性依据发证机构的定期监督获得保持。

本证书为变更证书,证书首次颁发日期: 2013年08月27日

主任: _____



中国质量认证中心

中国·北京·南四环西路188号9区100070

<http://www.cqc.com.cn>

C 0062600



PRODUCT CERTIFICATE

No.: CQC13012097386

NAME AND ADDRESS OF THE APPLICANT

Dongguan Better Electronics Technology Co., Ltd.
Room 601 of 16 Block, Xinzhu Yuan, No. 4 Xinzhu Road, Songshanlake Hightech Industrial Development
Zone, Dongguan City

NAME AND ADDRESS OF THE MANUFACTURER

Dongguan Better Electronics Technology Co., Ltd.
Room 601 of 16 Block, Xinzhu Yuan, No. 4 Xinzhu Road, Songshanlake Hightech Industrial Development
Zone, Dongguan City

NAME AND ADDRESS OF THE FACTORY

Dongguan Better Electronics Technology Co., Ltd. (V003591)
NanMen Village, HengKeng Administrative Zone LiaoBu Town, Dongguan, Guangdong, China.

NAME, MODEL AND SPECIFICATION

Sub-miniature Fuse-link
932 T125mAL250V、932 T250mAL250V

THE STANDARDS AND TECHNICAL REQUIREMENTS FOR THE PRODUCTS

GB9364.1-1997 GB9364.3-1997 CQC11-462125-2009附件2

CERTIFICATION MODEL

Type Testing of Product + Initial Factory Inspection + Follow up Factory Inspection

This is to certify that the above mentioned products have met the requirements of certification rules
CQC11-462125-2009.

Date of issue: Aug.24,2015

Validity of this certificate is subject to positive result of the regular follow up inspection by issuing
certification body until the expiry date.

Date of original certification: Aug.27,2013

President: _____

Wang Kejiao



CHINA QUALITY CERTIFICATION CENTRE

Section 9, No.188, Nansihuan Xilu, Beijing 100070 P.R.China
<http://www.cqc.com.cn>

C 0062600



产品认证证书

证书编号: CQC16012141544

申请人名称及地址

东莞市贝特电子科技股份有限公司
东莞市松山湖高新技术产业开发区新竹路4号新竹苑16座办公601

制造商名称及地址

东莞市贝特电子科技股份有限公司
东莞市松山湖高新技术产业开发区新竹路4号新竹苑16座办公601

生产企业名称及地址

东莞市贝特电子科技股份有限公司 (V003591)
东莞市寮步镇横坑南门村第二工业区C座、B座

产品名称和系列、规格、型号

超小型熔断体

932 T160mAL250V; 932 T200mAL250V; 932 T315mAL250V; 932 T400mAL250V

产品标准和技术要求

GB9364.1-1997; GB9364.3-1997; CQC11-462125-2009附件2

认证模式

产品型式试验+初次工厂检查+获证后监督

上述产品符合CQC11-462125-2009认证规则的要求, 特发此证。

发证日期: 2016年04月10日

证书有效期内本证书的有效性依据发证机构的定期监督获得保持。

主任: _____



中国质量认证中心

中国·北京·南四环西路188号9区100070

<http://www.cqc.com.cn>

C 0080089



PRODUCT CERTIFICATE

No.: CQC16012141544

NAME AND ADDRESS OF THE APPLICANT

Dongguan Better Electronics Technology Co.,Ltd.
Room 601 of 16 Block, Xinzhu Yuan, No. 4 Xinzhu Road, Songshanlake Hightech Industrial Development
Zone, Dongguan City

NAME AND ADDRESS OF THE MANUFACTURER

Dongguan Better Electronics Technology Co.,Ltd.
Room 601 of 16 Block, Xinzhu Yuan, No. 4 Xinzhu Road, Songshanlake Hightech Industrial Development
Zone, Dongguan City

NAME AND ADDRESS OF THE FACTORY

Dongguan Better Electronics Technology Co., Ltd. (V003591)
NanMen-Village,HengKeng-Administrative Zone-LiaoBu-Town-, Dongguan,Guangdong,China.

NAME, MODEL AND SPECIFICATION

Sub-miniature fuse-links

932 T160mAL250V; 932 T200mAL250V; 932 T315mAL250V; 932 T400mAL250V

THE STANDARDS AND TECHNICAL REQUIREMENTS FOR THE PRODUCTS

GB9364.1-1997;GB9364.3-1997;CQC11-462125-2009附件2

CERTIFICATION MODEL

Type Testing of Product + Initial Factory Inspection + Follow up Factory Inspection

This is to certify that the above mentioned products have met the requirements of certification rules
CQC11-462125-2009.

Date of issue: Apr.10,2016

Validity of this certificate is subject to positive result of the regular follow up inspection by issuing
certification body until the expiry date.

President:

Wang Kejiao



CHINA QUALITY CERTIFICATION CENTRE

Section 9, No.188, Nansihuan Xilu, Beijing 100070 P.R.China
<http://www.cqc.com.cn>

C 0080089



产品认证证书

证书编号: CQC11012062690

申请人名称及地址

东莞市贝特电子科技股份有限公司
东莞市松山湖高新技术产业开发区新竹路4号新竹苑16座办公601

制造商名称及地址

东莞市贝特电子科技股份有限公司
东莞市松山湖高新技术产业开发区新竹路4号新竹苑16座办公601

生产企业名称及地址

东莞市贝特电子科技股份有限公司 (V003591)
东莞市寮步镇横坑南门村第二工业区C座、B座

产品名称和系列、规格、型号

超小型熔断体

932 T500mAL250V, 932 T630mAL250V, 932 T800mAL250V, 932 T1AL250V, 932 T1.25AL250V, 932 T1.6AL250V, 932 T2AL250V, 932 T2.5AL250V, 932 T3.15AL250V, 932 T4AL250V, 932 T5AL250V, 932 T6.3AL250V

产品标准和技术要求

GB9364.1-1997 GB9364.3-1997 CQC11-462125-2009附件2

认证模式

产品型式试验+初次工厂检查+获证后监督

上述产品符合CQC11-462125-2009认证规则的要求, 特发此证。

发证日期: 2014年11月14日

证书有效期内本证书的有效性依据发证机构的定期监督获得保持。

本证书为变更证书, 证书首次颁发日期: 2011年09月22日

主任: _____



中国质量认证中心

中国·北京·南四环西路188号9区100070

<http://www.cqc.com.cn>

C 0064386



PRODUCT CERTIFICATE

No.: CQC11012062690

NAME AND ADDRESS OF THE APPLICANT

Dongguan Better Electronics Technology Co., Ltd.
Room 601 of 16 Block, Xinzhu Yuan, No. 4 Xinzhu Road, Songshanlake Hightech Industrial Development
Zone, Dongguan City

NAME AND ADDRESS OF THE MANUFACTURER

Dongguan Better Electronics Technology Co., Ltd.
Room 601 of 16 Block, Xinzhu Yuan, No. 4 Xinzhu Road, Songshanlake Hightech Industrial Development
Zone, Dongguan City

NAME AND ADDRESS OF THE FACTORY

Dongguan Better Electronics Technology Co., Ltd. (V003591)
NanMen Village, HengKen Administrative Zone LiaoBu Town, Dongguan, Guangdong

NAME, MODEL AND SPECIFICATION

Sub-miniature fuse-links

932 T500mAL250V,932 T630mAL250V,932 T800mAL250V,932 T1AL250V,932 T1.25AL250V,932 T1.6AL250V,932
T2AL250V,932 T2.5AL250V,932 T3.15AL250V,932 T4AL250V,932 T5AL250V,932 T6.3AL250V

THE STANDARDS AND TECHNICAL REQUIREMENTS FOR THE PRODUCTS

GB9364.1-1997 GB9364.3-1997 CQC11-462125-2009附件2

CERTIFICATION MODEL

Type Testing of Product + Initial Factory Inspection + Follow up Factory Inspection

This is to certify that the above mentioned products have met the requirements of certification rules
CQC11-462125-2009.

Date of issue: Nov.14,2014

Validity of this certificate is subject to positive result of the regular follow up inspection by issuing
certification body until the expiry date.

Date of original certification: Sep.22,2011

President: _____

Wang Kejiao



CHINA QUALITY CERTIFICATION CENTRE

Section 9, No.188, Nansihuan Xilu, Beijing 100070 P.R.China
<http://www.cqc.com.cn>

C 0064386



产品认证证书

证书编号: CQC15012121655

申请人名称及地址

东莞市贝特电子科技股份有限公司
东莞市松山湖高新技术产业开发区新竹路4号新竹苑16座办公601

制造商名称及地址

东莞市贝特电子科技股份有限公司
东莞市松山湖高新技术产业开发区新竹路4号新竹苑16座办公601

生产企业名称及地址

东莞市贝特电子科技股份有限公司 (V003591)
东莞市寮步镇横坑南门村第二工业区C座、B座

产品名称和系列、规格、型号

超小型熔断体

932 T8AL250V; 932 T10AL250V

产品标准和技术要求

GB9364.1-1997 GB9364.3-1997 CQC11-462125-2009附件2

认证模式

产品型式试验+初次工厂检查+获证后监督

上述产品符合CQC11-462125-2009认证规则的要求, 特发此证。

发证日期: 2015年02月05日

证书有效期内本证书的有效性依据发证机构的定期监督获得保持。

主任: _____



中国质量认证中心

中国·北京·南四环西路188号9区100070

<http://www.cqc.com.cn>

C 0066658



PRODUCT CERTIFICATE

No.: CQC15012121655

NAME AND ADDRESS OF THE APPLICANT

Dongguan Better Electronics Technology Co.,Ltd.
Room 601 of 16 Block, Xinzhu Yuan, No. 4 Xinzhu Road, Songshanlake Hightech Industrial Development
Zone, Dongguan City

NAME AND ADDRESS OF THE MANUFACTURER

Dongguan Better Electronics Technology Co.,Ltd.
Room 601 of 16 Block, Xinzhu Yuan, No. 4 Xinzhu Road, Songshanlake Hightech Industrial Development
Zone, Dongguan City

NAME AND ADDRESS OF THE FACTORY

Dongguan Better Electronics Technology Co., Ltd. (V003591)
NanMen Village, HengKeng Administrative Zone LiaoBu Town, Dongguan, Guangdong, China.

NAME, MODEL AND SPECIFICATION

Sub-miniature fuse-links

932 T8AL250V; 932 T10AL250V

THE STANDARDS AND TECHNICAL REQUIREMENTS FOR THE PRODUCTS

GB9364.1-1997 GB9364.3-1997 CQC11-462125-2009附件2

CERTIFICATION MODEL

Type Testing of Product + Initial Factory Inspection + Follow up Factory Inspection

This is to certify that the above mentioned products have met the requirements of certification rules
CQC11-462125-2009.

Date of issue: Feb.05,2015

Validity of this certificate is subject to positive result of the regular follow up inspection by issuing
certification body until the expiry date.

President:

Wang Kejiao



CHINA QUALITY CERTIFICATION CENTRE

Section 9, No.188, Nansihuan Xilu, Beijing 100070 P.R.China
<http://www.cqc.com.cn>

C 0066658



適合証明書

Certificate of Conformity

証明書番号 Certificate No.

PSE15020937

申請者照会番号 Applicant Reference

CJP2015102004-1199

発行年月日 Date of Issue

2015年11月12日

申請者 Applicant

DONGGUAN BETTER ELECTRONICS
TECHNOLOGY CO.,LTD

ROOM 601 OF 16 BLOCK, XINZHUYUAN, NO 4,
XINZHU ROAD, SONGSHANLAKE HIGHTECH
INDUSTRIAL DEVELOPMENT ZONE, DONGGUAN
CITY, GUANGDONG PROVINCE, P.R.CHINA 523808

製造工場 Factory

DONGGUAN BETTER ELECTRONICS
TECHNOLOGY CO.,LTD

NANMEN VILLAGE, HENGKENG
ADMINISTRATIVE ZONE LIAOBU TOWN,
DONGGUAN, GUANGDONG, P.R.CHINA 523413



検査の方法 Standard for Certificate

- 電気用品の技術基準の解釈 別表第十二 国際規格等に準拠した基準
J60127-1(H26); J60127-3(H20)

- 施行規則別表第四

Appendix 4 of the Enforcement Regulations

特定電気用品名:

Name of Specified Electrical
Appliance and Material

型式の区分:

Type Classification

モデル名:

Model

製造事業者:

Manufacturer

証明書の有効期間:

Validity of Certificate

その他の包装ヒューズ

Other enclosed fuses

(「添付書類」参照)

(Refer to Attachment)

932 T1AL250V, 932 T1.25AL250V, 932 T1.6AL250V, 932 T2AL250V,
932 T2.5AL250V, 932 T3.15AL250V, 932 T4AL250V, 932 T5AL250V

DONGGUAN BETTER ELECTRONICS TECHNOLOGY CO.,LTD

2022年11月11日までに有効です。

This certificate is expired on Nov. 11th, 2022

これは、上記申請者より申請のあった上記特定電気用品及び製造工場が、電気用品安全法第八条第一項に規定する技術基準及び同法第九条第二項の経済産業省令で定める基準に適合していることを証明するものです。

This is to certify that the above-mentioned Specified Electrical Appliances and Materials and the factory which the above-mentioned applicant applied for have been complied with the Technical Requirements stipulated by Article 8, Paragraph 1 of the Electrical Appliance and Material Safety Law and the requirements stipulated by the METI Ordinance specified in Article 9, paragraph 2 of the said law.

中国品質認証センター
CHINA QUALITY
CERTIFICATION CENTRE

氏名
Name

発行者
Issued by



中国100070北京市南四环西路188号9区

Section 9, No.188, Nansihuan Xilu, Beijing 100070, China

PJ 0004128



適合証明書

Certificate of Conformity

添付書類 Attachment 1

証明書番号(Certificate No.) :
PSE15020937

発行日 Date of Issue :
2015年11月12日

【 型式の区分 Type Classification 】

特定電気用品 :
(Name of Specified Electrical Appliance and Material)

その他の包装ヒューズ
Other enclosed fuses

要素	区分
定格電圧	(1) 125V以下のもの (2) 125Vを超えるもの
定格電流 (定格電流表示のあるものの場合に限る。)	(1) 5A以下のもの (2) 5Aを超え15A以下のもの (3) 15Aを超え30A以下のもの (4) 30Aを超え60A以下のもの (5) 60Aを超え100A以下のもの (6) 100Aを超えるもの
適用電動機の定格容量 (定格電流表示のないものの場合に限る。)	(1) 単相で200W以下のもの (2) 単相で200Wを超え400W以下のもの (3) 単相で400Wを超え750W以下のもの (4) 単相で750Wを超えるもの (5) 3相で750W以下のもの (6) 3相で750Wを超え2.2kW以下のもの (7) 3相で2.2kWを超え3.7kW以下のもの (8) 3相で3.7kWを超え7.5kW以下のもの (9) 3相で7.5kWを超えるもの
可溶体の主材料	(1) 銀のもの (2) アルミニウムのもの (3) 亜鉛のもの (4) 鉛のもの (5) 銅のもの (6) その他のもの

中国品質認証センター
CHINA QUALITY
CERTIFICATION CENTRE

氏名
Name

発行者
Issued by



中国100070北京市南四环西路188号9区

Section 9, No.188, Nansihuan Xilu, Beijing 100070, China



適合証明書

Certificate of Conformity

添付書類 Attachment 2

証明書番号(Certificate No.) :
PSE15020937

発行日 Date of Issue :
2015年11月12日

【 型式の区分 Type Classification 】

特定電気用品 :
(Name of Specified Electrical Appliance and Material)

その他の包装ヒューズ
Other enclosed fuses

可溶体の数	(1) 1のもの (2) 2以上のもの
再使用 (管形ヒューズを除く。)	(1) できるもの (2) できないもの
内部充てん物	(1) あるもの (2) ないもの
筒 (内筒を除く。) の材料	(1) フェノール樹脂のもの (2) ファイバーのもの (3) 磁器のもの又はガラスのもの (4) ポリエステル樹脂のもの (5) メラミン樹脂のもの (6) ユリア樹脂のもの (7) その他のもの
端子	(1) 刃形のもの (2) 筒形のもの (3) 締付け形のもの (4) リード線付きのもの (5) その他のもの
排気孔	(1) あるもの (2) ないもの
溶断の表示	(1) あるもの (2) ないもの
用途	(1) 電動機用のもの (2) 電子機器用のもの (3) 短絡保護専用のもの (4) その他のもの

中国品質認証センター
CHINA QUALITY
CERTIFICATION CENTRE

氏名
Name

発行者
Issued by



中国100070北京市南四环西路188号9区

Section 9, No.188, Nansihuan Xilu, Beijing 100070, China



適合証明書

Certificate of Conformity

添付書類 Attachment 3

証明書番号(Certificate No.) :
PSE15020937

発行日 Date of Issue :
2015年11月12日

【 型式の区分 Type Classification 】

特定電気用品 :
(Name of Specified Electrical Appliance and Material)

その他の包装ヒューズ
Other enclosed fuses

定格遮断電流	<ul style="list-style-type: none"> (1) 100A以下のもの (2) 100Aを超え300A以下のもの (3) 300Aを超え500A以下のもの (4) 500Aを超え1,000A以下のもの (5) 1,000Aを超え1,500A以下のもの (6) 1,500Aを超え2,500A以下のもの (7) 2,500Aを超え5,000A以下のもの (8) 5,000Aを超え7,500A以下のもの (9) 7,500Aを超え10,000A以下のもの (10) 10,000Aを超え15,000A以下のもの (11) 15,000Aを超え20,000A以下のもの (12) 20,000Aを超え25,000A以下のもの (13) 25,000Aを超え30,000A以下のもの (14) 30,000Aを超えるもの
--------	--

中国品質認証センター
CHINA QUALITY
CERTIFICATION CENTRE

氏名
Name

発行者
Issued by



中国100070北京市南四环西路188号9区

Section 9, No.188, Nansihuan Xilu, Beijing 100070, China

Zertifikat

Certificate



Zertifikat Nr. *Certificate No.*
R 50279350

Blatt *Page*
0001

<i>Ihr Zeichen Client Reference</i>	<i>Unser Zeichen Our Reference</i>	<i>Ausstellungsdatum Date of Issue</i>	<i>(day/mo/yr)</i>
	05-YFC- 16058722 001	28.03.2014	

Genehmigungsinhaber *License Holder*

Dongguan Better Electronics
Technology Co., Ltd.
Room No. 102, 103 of 3rd block
114 of 4th Block Innovtive Tech.
Park of Songshan Lake High-tech Ind.
Park, Dongguan, Guangdong
P.R. China

Fertigungsstätte *Manufacturing Plant*

Dongguan Better Electronics
Technology Co., Ltd.
Nanmen Village, Hengken
Administrative Zone, Liaobu Town
Dongguan, Guangdong
Guangdong
P.R. China

Prüfzeichen *Test Mark*



Type Approved
Safety
Regular Production
Surveillance

www.tuv.com
ID 2000000000

Gepprüft nach *Tested acc. to*
EN 60127-1:2006+A1
EN 60127-7:2013

Zertifiziertes Produkt *(Geräteidentifikation)*
Certified Product (Product Identification)

Lizenzentgelte - Einheit
License Fee - Unit

Fuse Link (Miniature Fuse-link)

Type Designation	: 932	15
Trademark	: Better(Logo)	
Rated Voltage	: AC 300V	
Rated Current	: 500mA; 630mA; 800mA; 1A; 1,25A; 1,6A; 2A; 2,5A; 3,15A; 4A; 5A; 6,3A 8A, 10A	
T/I Characteristic	: t2=2min; t3=400ms; t4=10s; t5=150ms t6=3s; t7=20ms; t8=150ms	
Rated Breaking Capacity:	AC 50A or 10In (which is higher)	

Remark:

- 1)The product also comply with IEC60127-1:2006+A1 and IEC60127-7:2013.
- 2)The labelling requirements acc. to EU Directive 2001/95 have to be observed for distribution within the EEA.

ANLAGE (Appendix): 1

Dem Zertifikat liegt unsere Prüf- und Zertifizierungsordnung zugrunde und es bestätigt die Konformität des Produktes mit den oben genannten Standards und Prüfgrundlagen. Zusätzliche Anforderungen in Ländern, in denen das Produkt in Verkehr gebracht werden soll, müssen zusätzlich betrachtet werden. Die Herstellung des zertifizierten Produktes wird überwacht.
This certificate is based on our Testing and Certification Regulation and states the conformity of the product with the standards and testing requirements as indicated above. Any additional requirements in countries where the product is going to be marketed have to be considered additionally. The manufacturing of the certified product is subject to surveillance.

TÜV Rheinland LGA Products GmbH - Tillystraße 2 - 90431 Nürnberg

Tel.: (+49/221)8 06 - 13 71 e-mail: cert-validity@de.tuv.com
Fax: (+49/221)8 06 - 39 35 http://www.tuv.com/safety



G. Yin

Zertifikat

Certificate

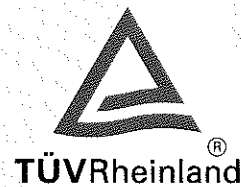

Zertifikat Nr. *Certificate No.*
R 50279350

Blatt *Page*
0002

Ihr Zeichen *Client Reference*

Unser Zeichen *Our Reference*

Ausstellungsdatum

Date of Issue
(day/mo/yr)

05-YFC- 16058722 002

20.08.2015

Genehmigungsinhaber *License Holder*

Dongguan Better Electronics
Technology Co., Ltd.
Room 601 of 16 Block, Xinzhu Yuan
No 4, Xinzhu Road, Songshan Lake
Hightech Ind. Development Zone
Dongguan City, Guangdong Province
P.R. China

Fertigungsstätte *Manufacturing Plant*

Dongguan Better Electronics
Technology Co., Ltd.
Nanmen Village, Hengkeng
Administrative Zone, Liaobu Town
Dongguan, Guangdong
P.R. China

Prüfzeichen *Test Mark*

Geprüft nach *Tested acc. to*

EN 60127-1:2006+A1
EN 60127-7:2013



Zertifiziertes Produkt (Geräteidentifikation)
Certified Product (Product Identification)

Lizenzentgelte - Einheit
License Fee - Unit

Fuse Link (Miniature Fuse-link)

As page 0001

Change

Address of the license holder: see above

Additional

Rated Current : 1) 125mA; 160mA; 200mA;
250mA; 315mA; 400mA
2) 500mA
Rated Voltage : 1) AC 250V/300V; 2) 250V

Remark:

- 1) The product also comply with IEC60127-1:2006+A1 and IEC60127-7:2013.
- 2) The labelling requirements acc. to EU Directive 2001/95 have to be observed for distribution within the EEA.

ANLAGE (Appendix): 1.1

Dem Zertifikat liegt unsere Prüf- und Zertifizierungsordnung zugrunde und es bestätigt die Konformität des Produktes mit den oben genannten Standards und Prüfgrundlagen. Zusätzliche Anforderungen in Ländern, in denen das Produkt in Verkehr gebracht werden soll, müssen zusätzlich betrachtet werden. Die Herstellung des zertifizierten Produktes wird überwacht.

This certificate is based on our Testing and Certification Regulation and states the conformity of the product with the standards and testing requirements as indicated above. Any additional requirements in countries where the product is going to be marketed have to be considered additionally. The manufacturing of the certified product is subject to surveillance.

TÜV Rheinland LGA Products GmbH - Tillystraße 2 - 90431 Nürnberg
Tel.: (+49/221)8 06 - 13 71 e-mail: cert-validity@de.tuv.com
Fax: (+49/221)8 06 - 39 35 http://www.tuv.com/safety



G. Yin

Zertifikat

Certificate



Zertifikat Nr. *Certificate No.*
R 50279350

Blatt *Page*
0003

Ihr Zeichen *Client Reference*

Unser Zeichen *Our Reference*

Ausstellungsdatum
01.02.2018

Date of Issue
(day/mo/yr)

05-YFC- 16058722 003

Genehmigungsinhaber *License Holder*

Dongguan Better Electronics
Technology Co., Ltd.
Room 601 of 16 Block, Xinzhu Yuan
No 4, Xinzhu Road, Songshan Lake
Hightech Ind. Development Zone
Dongguan City, Guangdong Province
P. R. China

Fertigungsstätte *Manufacturing Plant*

Dongguan Better Electronics
Technology Co., Ltd.
Nanmen Village, Hengkeng
Administrative Zone, Liaobu Town
Dongguan, Guangdong
P. R. China

Prüfzeichen *Test Mark*



Type Approved
Safety
Regular Production
Surveillance

www.tuv.com
ID 2000000000

Geprüft nach *Tested acc. to*

EN 60127-1:2006+A1+A2
EN 60127-7:2016

Zertifiziertes Produkt *(Geräteidentifikation)*
Certified Product (Product Identification)

Lizenzentgelte - Einheit
License Fee - Unit

Fuse Link (Miniature Fuse-link)

as pages 0001 to 0002

Change

Test Requirement : see above

Remark:

- 1) The product also comply with IEC60127-1:2006+A1+A2 and IEC60127-7:2015.
- 2) The labelling requirements acc. to EU Directive 2001/95 have to be observed for distribution within the EEA.

Dem Zertifikat liegt unsere Prüf- und Zertifizierungsordnung zugrunde und es bestätigt die Konformität des Produktes mit den oben genannten Standards und Prüfgrundlagen. Zusätzliche Anforderungen in Ländern, in denen das Produkt in Verkehr gebracht werden soll, müssen zusätzlich betrachtet werden. Die Herstellung des zertifizierten Produktes wird überwacht.
This certificate is based on our Testing and Certification Regulation and states the conformity of the product with the standards and testing requirements as indicated above. Any additional requirements in countries where the product is going to be marketed have to be considered additionally. The manufacturing of the certified product is subject to surveillance.

TÜV Rheinland LGA Products GmbH - Tillystraße 2 - 90431 Nürnberg
Tel.: (+49/221)8 06 - 13 71 e-mail: cert-validity@de.tuv.com
Fax: (+49/221)8 06 - 39 35 http://www.tuv.com/safety



GUTACHTEN MIT FERTIGUNGSÜBERWACHUNG CERTIFICATE OF CONFORMITY WITH FACTORY SURVEILLANCE

Dongguan Better Electronics
Technology Co., Ltd.
Room 601 of 16 Block, Xinzhu Yuan
No 4, Xinzhu Road
523808 DONGGUAN
CHINA

ist berechtigt, für ihr Produkt /
is authorized to use for their product

Kleinstsicherungseinsatz
Sub-miniature fuse-link

die hier abgebildeten markenrechtlich geschützten Zeichen
für die ab Blatt 2 aufgeführten Typen zu benutzen /
the legally protected Marks as shown below for the types referred to on page 2 ff.



REG.-Nr. D743 oder/or



oder/or VDE-REG.-Nr. D743

REG.-Nr. D743

Geprüft und zertifiziert nach /
Tested and certified according to

DIN EN 60127-1 (VDE 0820-1):2015-12; EN 60127-1:2006+A1:2011+A2:2015
DIN EN 60127-3 (VDE 0820-3):2015-11; EN 60127-3:2015
IEC 60127-1:2006
IEC 60127-1:2006/AMD1:2011
IEC 60127-1:2006/AMD2:2015
IEC 60127-3:2015



Aktenzeichen: 5015514-1170-0007 / 228698

File ref.:

Ausweis-Nr. 40033369

Blatt 1

Certificate No.

Page

Weitere Bedingungen siehe Rückseite und Folgeblätter /
further conditions see overleaf and following pages

Offenbach, 2011-09-19

(letzte Änderung / updated 2016-11-21)

VDE Prüf- und Zertifizierungsinstitut GmbH
VDE Testing and Certification Institute
Zertifizierungsstelle / Certification

M. Tasotti

VDE Zertifikate sind nur gültig bei Veröffentlichung unter:
VDE certificates are valid only when published on:

<http://www.vde.com/zertifikat>
<http://www.vde.com/certificate>

Name und Sitz des Genehmigungs-Inhabers / Name and registered seat of the Certificate holder

Dongguan Better Electronics Technology Co., Ltd., Room 601 of 16 Block, Xinzhu Road,
523808 DONGGUAN, Guangdong, CHINA

Aktenzeichen / File ref.

5015514-1170-0007 / 228698 / CC2 / EUL

letzte Änderung / updated

2016-11-21

Datum / Date

2011-09-19

Dieses Blatt gilt nur in Verbindung mit Blatt 1 des Gutachtens mit Fertigungsüberwachung Nr. 40033369.

This supplement is only valid in conjunction with page 1 of the Certificate of Conformity with factory surveillance No. 40033369.

Kleinleistungseinsatz Sub-miniature fuse-link

Typ(en) / Type(s)

932

Bemessungsspannung
Rated voltage

AC 250 V

Bemessungsstrom
Rated current

630 mA; 800 mA; 1 A; 1,25 A; 1,6 A; 2 A;
2,5 A; 3,15 A; 4 A; 5 A; 6,3 A

Normblatt
Standard sheet

4

Kennzeichnung der Charakteristik
Characteristic symbol

T

Bemessungsausschaltvermögen
Rated breaking capacity

35 A bzw. 10 x In
35 A resp. 10 x In

Zeit/Strom-Charakteristik
Time/current-characteristic

träge
time-lag

Anmerkung

Rechteckige Bauform.
Die Prüfspannung in Abschnitt 9.2 war DC 63 V.

Remark

Rectangular shape.
The test voltage in clause 9.2 was DC 63 V.

Dieser Zeichengenehmigungs-Ausweis bildet eine Grundlage für die EG-Konformitätserklärung und CE-Kennzeichnung durch den Hersteller oder dessen Bevollmächtigten und bescheinigt die Konformität mit den grundlegenden Schutzanforderungen der **EG-Niederspannungsrichtlinie 2014/35/EU**.

*This Marks Approval is a basis for the EC Declaration of Conformity and the CE Marking by the manufacturer or his agent and proves the conformity with the essential safety requirements of the **EC Low-Voltage Directive 2014/35/EU**.*

VDE Prüf- und Zertifizierungsinstitut GmbH
VDE Testing and Certification Institute
Fachgebiet CC2
Section CC2

VDE Prüf- und Zertifizierungsinstitut Gutachten mit Fertigungsüberwachung

Ausweis-Nr. / Beiblatt /
Certificate No. Supplement
40033369

Name und Sitz des Genehmigungs-Inhabers / *Name and registered seat of the Certificate holder*

Dongguan Better Electronics Technology Co., Ltd., Room 601 of 16 Block, Xinzhu Yuan, No 4, Xinzhu Road,
523808 DONGGUAN, Guangdong, CHINA

Aktenzeichen / *File ref.*

5015514-1170-0007 / 228698 / CC2 / EUL

letzte Änderung / *updated*

2016-11-21

Datum / *Date*

2011-09-19

Dieses Beiblatt ist Bestandteil des Gutachtens mit Fertigungsüberwachung Nr. 40033369.

This supplement is part of the Certificate of Conformity with factory surveillance No. 40033369.

Kleinstsicherungseinsatz

Sub-miniature fuse-link

Fertigungsstätte(n)

Place(s) of manufacture

Referenz/*Reference*

30017543

Dongguan Better Electronics
Technology Co., Ltd.
Nanmen Village
Hengkeng Administrative Zone
523413 LIAOBU TOWN, DONGGUAN
Guangdong
CHINA

VDE Prüf- und Zertifizierungsinstitut GmbH

VDE Testing and Certification Institute

Fachgebiet CC2

Section CC2

Name und Sitz des Genehmigungs-Inhabers / *Name and registered seat of the Certificate holder*

Dongguan Better Electronics Technology Co., Ltd., Room 601 of 16 Block, Xinzhu Road,
523808 DONGGUAN, Guangdong, CHINA

Aktenzeichen / *File ref.*

5015514-1170-0007 / 228698 / CC2 / EUL

letzte Änderung / *updated*

2016-11-21

Datum / *Date*

2011-09-19

Dieses Blatt gilt nur in Verbindung mit Blatt 1 des Gutachtens mit Fertigungsüberwachung Nr. 40033369.

This supplement is only valid in conjunction with page 1 of the Certificate of Conformity with factory surveillance No. 40033369.

Genehmigung zum Benutzen des auf Seite 1 abgebildeten markenrechtlich geschützten Zeichens des VDE:

Grundlage für die Benutzung sind die Allgemeinen Geschäftsbedingungen (AGB) der VDE Prüf- und Zertifizierungsinstitut GmbH (www.vde.com\AGB-Institut). Das Recht zur Benutzung erstreckt sich nur auf die bezeichnete Firma mit den genannten Fertigungsstätten und die oben aufgeführten Produkte mit den zugeordneten Bezeichnungen. Die Fertigungsstätte muss so eingerichtet sein, dass eine gleichmäßige Herstellung der geprüften und zertifizierten Ausführung gewährleistet ist.

Die Genehmigung ist so lange gültig wie die VDE-Bestimmungen gelten, die der Zertifizierung zugrunde gelegen haben, sofern sie nicht auf Grund anderer Bedingungen aus der VDE Prüf- und Zertifizierungsordnung (PM102) zurückgezogen werden muss.

Der Gültigkeitszeitraum einer VDE-GS-Zeichengenehmigung kann auf Antrag verlängert werden. Bei gesetzlichen und / oder normativen Änderungen kann die VDE-GS-Zeichengenehmigung ihre Gültigkeit zu einem früheren als dem angegebenen Datum verlieren.

Produkte, die das Biozid Dimethylfumarat (DMF) enthalten, dürfen gemäß der Kommissionsentscheidung 2009/251/EG nicht mehr in den Verkehr gebracht oder auf dem Markt bereitgestellt werden.

Der VDE-Zeichengenehmigungsausweis wird ausschließlich auf der ersten Seite unterzeichnet.

Approval to use the legally protected Mark of the VDE as shown on the first page:

Basis for the use are the general terms and conditions of the VDE Testing and Certification Institute (www.vde.com\terms-institute). The right to use the mark is granted only to the mentioned company with the named places of manufacture and the listed products with the related type references. The place of manufacture shall be equipped in a way that a constant manufacturing of the certified construction is assured.

The approval is valid as long as the VDE specifications are in force, on which the certification is based on, unless it is withdrawn according to the VDE Testing and Certification Procedure (PM102E).

The validity period of a VDE-GS-Mark Approval may be prolonged on request. In case of changes in legal and / or normative requirements, the validity period of a VDE-GS-Mark Approval may be shortened.

Products containing the biocide dimethylfumarate (DMF) may not be marketed or made available on the EC market according to the Commission Decision 2009/251/EC.

The approval is solely signed on the first page.

접수번호 : 13-012442-02
(Receipt No.)



전기용품안전인증서

Electrical Appliances Safety Certificate

안전인증번호 : SU05042-13001
(Certificate No.)

제조업자명 : Dongguan Better Electronics Technoloy Co.,Ltd
(Factory)

대표자명 : Han Lu
(President)

제조공장의소재지 : 2nd Industrial Zone, Nanmen Village, Hengkeng, Liao Bu Town, Dongguan, Guangdong, P.R.China
(Factory Address)

제품명 : 퓨즈(Sub-miniature fuse-links)
(Product)

기본모델명 : 932 T1AL250V
(Basic Model)

정격 : AC250V, 1A
(Rating)

파생모델명 : See the attachment 2
(Series Model)

적용기준 : K60127-1(2011-12), K60127-3(2006-07)
(Standard)

「전기용품안전 관리법 시행규칙」 제6조제2항에 따라 위의 전기용품에 대하여 안전인증서를 발급합니다.

We Issue Electrical Appliances Safety Certification as above product by Article 6 Section 2 of the Electrical Appliances Safety Control Law Enforcement Regulation.

2013년 04월 12일



한국산업기술시험원장
KOREA TESTING LABORATORY



* 이 인증서는 「전기용품안전 관리법」에 따른 전기용품 안전성 확인에 한정된 것이며, 그 밖의 다른 법률이 적용되는 제품의 경우에는 해당 법률에 따라 추가로 인증·허가 등을 받아야 합니다.

- 첨부 :
(Annex)
1. 안전관리부품 및 재질목록 (List of Critical Components)
 2. 기본모델·파생모델의 내용 (General Descriptions of Certified Products)
 3. 전기용품안전인증의 변경 현황 (Status of Certificate Revisions)

첨부 1 : 안전관리부품 및 재질목록
List of Critical Components

부품명(회로기호) Component(Part no.)	제조사(상표명) Manufacturer(Brand)	모델명(형식) Model(Type)	정격 또는 특성 Rating or Characteristics	인증마크 Tested by
Not applicable				
<p><input type="checkbox"/> 유의사항 (Attention) :</p> <p>1. 안전관리부품은 전기적인 안전에 직접적인 영향을 주는 부품으로서 안전인증기관이 정기공장검사 시 확인 관리 하는 사항입니다. 따라서 상기목록에 기재된 사항을 변경하거나 또는 복수등재를 원하시는 경우는 안전인증기관에 인증변경신청을 하여야 합니다.</p> <p><i>As the "Critical components" are parts in directly related with safety, these components shall be checked during a factory inspection by the certification body. In case of applying multiful listing or changing the items above, the certification revision shall be applied.</i></p> <p>2. 인증변경신청 없이 임의로 변경하는 경우는, 전기용품안전관리법 제 8 조제 1 항의 규정에 의한 안전인증취소 사유가 됨을 유의하시기 바랍니다.</p> <p><i>The Safety Certification will be cancelled under the Safety Control Law for Electrical Appliances, Paragraph 1 of Article 8 if the contents of the Certification is altered without our authorization.</i></p>				

FP511-10-00

첨부 2 : 기본모델 · 파생모델의 내용
General description of Certified Products

파생모델명 Derivative model	기본모델과의 차이점 Differences between the basic and derivative model(s)
932 T1.25AL250V	Rated current(1.25A) is different
932 T1.6AL250V	Rated current(1.6A) is different
932 T2AL250V	Rated current(2A) is different
932 T2.5AL250V	Rated current(2.5A) is different
제품특기사항 및 시험조건 Remarks & Test conditions	
<p>1. Test Report Ref. No. : 13-012442-02 (2013.04.03.)</p> <p>2. Product Description</p> <ul style="list-style-type: none"> - T1AL250V - Rated breaking capacity : 35 A - Time-lag type - Low-breaking capacity - Standard sheet 4 <p><input type="checkbox"/> 본 제품의 시험내용에 관하여 문의하실 사항이 있으시면 아래 연락처로 문의하시기 바랍니다. 시험담당자 : 전기전자본부 광융합/부품평가센터 조인철 / (02)860-1425</p> <p><input type="checkbox"/> <i>If you have any question on product testing, please contact the person below :</i> <i>Job holder : Electrical and Electronic Division Lighting Appliance & Electrical Testing Center, INCHUL CHO/ +82 2 8601-425</i></p>	

FP511-09-00

첨부 3 : 전기용품안전인증의 변경 현황
Status of Certificate Revisions

변경발급 내용 Contents of Certificate Revisions
Not applicable

FP511-11-00

접수번호 : 13-012442-03
(Receipt No.)



전기용품안전인증서

Electrical Appliances Safety Certificate

안전인증번호 : SU05042-13002
(Certificate No.)

제조업자명 : Dongguan Better Electronics Technoloy Co.,Ltd
(Factory)

대표자명 : Han Lu
(President)

제조공장의 소재지 : 2nd Industrial Zone, Nanmen Village, Hengkeng, Liao Bu Town, Dongguan, Guangdong, P.R.China
(Factory Address)

제품명 : 퓨즈(Sub-miniature fuse-links)
(Product)

기본모델명 : 932 T3.15AL250V
(Basic Model)

정격 : AC250V, 3.15A
(Rating)

파생모델명 : See the attachment 2
(Series Model)

적용기준 : K60127-1(2011-12), K60127-3(2006-07)
(Standard)

「전기용품안전 관리법 시행규칙」 제6조제2항에 따라 위의 전기용품에 대하여 안전인증서를 발급합니다.

We Issue Electrical Appliances Safety Certification as above product by Article 6 Section 2 of the Electrical Appliances Safety Control Law Enforcement Regulation.

2013년 04월 12일



한국산업기술시험원장
KOREA TESTING LABORATORY



* 이 인증서는 「전기용품안전 관리법」에 따른 전기용품 안전성 확인에 한정된 것이며, 그 밖의 다른 법률이 적용되는 제품의 경우에는 해당 법률에 따라 추가로 인증·허가 등을 받아야 합니다.

- 첨부 : (Annex)
1. 안전관리부품 및 재질목록 (List of Critical Components)
 2. 기본모델·파생모델의 내용 (General Descriptions of Certified Products)
 3. 전기용품안전인증의 변경 현황 (Status of Certificate Revisions)

첨부 1 : 안전관리부품 및 재질목록
 List of Critical Components

부품명(회로기호) Component(Part no.)	제조사(상표명) Manufacturer(Brand)	모델명(형식) Model(Type)	정격 또는 특성 Rating or Characteristics	인증마크 Tested by
Not applicable				
<p><input type="checkbox"/> 유의사항 (Attention) :</p> <p>1. 안전관리부품은 전기적인 안전에 직접적인 영향을 주는 부품으로서 안전인증기관이 정기공장검사 시 확인 관리 하는 사항입니다. 따라서 상기목록에 기재된 사항을 변경하거나 또는 복수등재를 원하시는 경우는 안전인증기관에 인증변경신청을 하여야 합니다.</p> <p><i>As the "Critical components" are parts in directly related with safety, these components shall be checked during a factory inspection by the certification body. In case of applying multiful listing or changing the items above, the certification revision shall be applied.</i></p> <p>2. 인증변경신청 없이 임의로 변경하는 경우는, 전기용품안전관리법 제 8 조제 1 항의 규정에 의한 안전인증취소 사유가 됨을 유의하시기 바랍니다.</p> <p><i>The Safety Certification will be cancelled under the Safety Control Law for Electrical Appliances, Paragraph 1 of Article 8 if the contents of the Certification is altered without our authorization.</i></p>				

FP511-10-00

첨부 2 : 기본모델 · 파생모델의 내용
General description of Certified Products

파생모델명 Derivative model	기본모델과의 차이점 Differences between the basic and derivative model(s)
932 T4AL250V	Rated current(4A) and Rated breaking capacity(40A) are different
932 T5AL250V	Rated current(5A) and Rated breaking capacity(50A) are different
932 T6.3AL250V	Rated current(6.3A) and Rated breaking capacity(63A) are different
제품특기사항 및 시험조건 Remarks & Test conditions	
<p>1. Test Report Ref. No. : 13-012442-03 (2013.04.03.)</p> <p>2. Product Description</p> <ul style="list-style-type: none"> - T3.15AL250V - Rated breaking capacity : 35 A - Time-lag type - Low-breaking capacity - Standard sheet 4 <p><input type="checkbox"/> 본 제품의 시험내용에 관하여 문의하실 사항이 있으시면 아래 연락처로 문의하시기 바랍니다. 시험담당자 : 전기전자본부 광융합/부품평가센터 조인철 / (02)860-1425</p> <p><input type="checkbox"/> <i>If you have any question on product testing, please contact the person below :</i> <i>Job holder : Electrical and Electronic Division Lighting Appliance & Electrical Testing Center, INCHUL CHO/</i> <i>+82 2 8601-425</i></p>	

FP511-09-00

첨부 3 : 전기용품안전인증의 변경 현황
Status of Certificate Revisions

변경발급 내용 Contents of Certificate Revisions
Not applicable

FP511-11-00

접수번호 : 13-012442-01
(Receipt No.)



전기용품안전인증서

Electrical Appliances Safety Certificate

안전인증번호 : SU05042-13003
(Certificate No.)

제조업자명 : Dongguan Better Electronics Technoloy Co.,Ltd
(Factory)

대표자명 : Han Lu
(President)

제조공장의소재지 : 2nd Industrial Zone, Nanmen Village, Hengkeng,
(Factory Address) Liao Bu Town, Dongguan, Guangdong, P.R.China

제품명 : 퓨즈(Sub-miniature fuse-links)
(Product) (Fuse)

기본모델명 : 932 T500mAL250V
(Basic Model)

정격 : AC 250 V 500 mA
(Rating)

파생모델명 : 932 T630mAL250V, 932 T800mAL250V
(Series Model)

적용기준 : K60127-1(2011-12), K60127-3(2006-07)
(Standard)

「전기용품안전 관리법 시행규칙」 제6조제2항에 따라 위의 전기용품에 대하여 안전인증서를 발급합니다.

We Issue Electrical Appliances Safety Certification as above product by Article 6 Section 2 of the Electrical Appliances Safety Control Law Enforcement Regulation.

2013년 05월 07일



한국산업기술시험원장
KOREA TESTING LABORATORY



* 이 인증서는 「전기용품안전 관리법」에 따른 전기용품 안전성 확인에 한정된 것이며, 그 밖의 다른 법률이 적용되는 제품의 경우에는 해당 법률에 따라 추가로 인증·허가 등을 받아야 합니다.

- 첨부 : (Annex)
1. 안전관리부품 및 재질목록 (List of Critical Components)
 2. 기본모델·파생모델의 내용 (General Descriptions of Certified Products)
 3. 전기용품안전인증의 변경 현황 (Status of Certificate Revisions)

첨부 1 : 안전관리부품 및 재질목록
 List of Critical Components

부품명(회로기호) Component(Part no.)	제조사(상표명) Manufacturer(Brand)	모델명(형식) Model(Type)	정격 또는 특성 Rating or Characteristics	인증마크 Tested by
Not applicable				
<p><input type="checkbox"/> 유의사항 (Attention) :</p> <p>1. 안전관리부품은 전기적인 안전에 직접적인 영향을 주는 부품으로서 안전인증기관이 정기공장검사 시 확인 관리 하는 사항입니다. 따라서 상기목록에 기재된 사항을 변경하거나 또는 복수등재를 원하시는 경우는 안전인증기관에 인증변경신청을 하여야 합니다.</p> <p><i>As the "Critical components" are parts in directly related with safety, these components shall be checked during a factory inspection by the certification body. In case of applying multiful listing or changing the items above, the certification revision shall be applied.</i></p> <p>2. 인증변경신청 없이 임의로 변경하는 경우는, 전기용품안전관리법 제 8 조제 1 항의 규정에 의한 안전인증취소 사유가 됨을 유의하시기 바랍니다.</p> <p><i>The Safety Certification will be cancelled under the Safety Control Law for Electrical Appliances, Paragraph 1 of Article 8 if the contents of the Certification is altered without our authorization.</i></p>				

FP511-10-00

첨부 2 : 기본모델 · 파생모델의 내용
 General description of Certified Products

파생모델명 Derivative model	기본모델과의 차이점 Differences between the basic and derivative model(s)
932 T630mAL250V	Rated current(630mA) is different
932 T800mAL250V	Rated current(800mA) is different
제품특기사항 및 시험조건 Remarks & Test conditions	
<p>1. Test Report Ref. No. : 13-012442-01 (2013.04.03.)</p> <p>2. Product Description</p> <ul style="list-style-type: none"> - T500mAL250V - Rated breaking capacity : 35 A - Time-lag type - Low-breaking capacity - Standard sheet 4 	
<p>□ 본 제품의 시험내용에 관하여 문의하실 사항이 있으시면 아래 연락처로 문의하시기 바랍니다. 시험담당자 : 전기전자본부 광융합/부품평가센터 조인철 / (02)860-1425</p> <p>□ <i>If you have any question on product testing, please contact the person below :</i> <i>Job holder : Electrical and Electronic Division Lighting Appliance & Electrical Testing Center, INCHUL CHO/</i> <i>+82 2 8601-425</i></p>	

FP511-09-00

첨부 3 : 전기용품안전인증의 변경 현황
 Status of Certificate Revisions

변경발급 내용 Contents of Certificate Revisions
Not applicable

FP511-11-00



By Royal Charter

Kitemark™ Certificate

This is to certify that:

Dongguan Better Electronics Technology
Co., Ltd.
Room 601 of 16 Block, Xinzhu Yuan
No. 4, Xinzhu Road, Songshan Lake
Hightech Industrial Development Zone
Dongguan
Guangdong
523808
China

Holds Certificate Number:

KM 677189

In respect of:

BS EN 60127
Cartridge fuse-links

This issues the right and licence to use the Kitemark in accordance with the Kitemark Terms and Conditions governing the use of the Kitemark, as may be updated from time to time by BSI Assurance UK Ltd (the "Conditions"). All defined terms in this Certificate shall have the same meaning as in the Conditions.

The use of the Kitemark is authorized in respect of the Product(s) detailed on this Certificate provided at or from the above address.

For and on behalf of BSI:

Gary Fenton, Global Product Certification Director

First Issued: 2017-09-19

Latest Issue: 2017-09-19



Page: 1 of 3

...making excellence a habit.™

This certificate has been issued by and remains the property of BSI Assurance UK Ltd, Kitemark Court, Davy Avenue, Knowlhill, Milton Keynes MK5 8PP, United Kingdom and should be returned immediately upon request. To check its validity telephone +44 (0) 345 080 9000. An electronic certificate can be authenticated [online](#).

BSI Assurance UK Limited, registered in England under number 7805321 at 389 Chiswick High Road, London W4 4AL, UK.
A member of BSI Group of Companies.

Kitemark™ Certificate

No. KM 677189

Group 2: Miniature fuses - sub-miniature fuse-links, Standard Sheet 4, BS EN 60127-3:2015
(BS EN 60127-1:2006+A2:2015)

Series 932, time-lag, low breaking capacity.		
Rating	CB Reference Reports	Additional reference reports
T3.15AL250V	CVC2017-0474/1	Not applicable.
T5AL250V	CVC2017-0474/2	
T8AL250V	CVC2017-0474/3	
T10AL250V	CVC2017-0474/4	

Products listed on the Kitemark licence are manufactured at the following location:

Dongguan Better Electronics Technology Co., Ltd.
Nanmen Village, Hengkeng Administrative Zone
Liaobu Town
Dongguan
Guangdong
523413
China

First Issued: 2017-09-19

Latest Issue: 2017-09-19

Page: 3 of 3

This certificate has been issued by and remains the property of BSI Assurance UK Ltd, Kitemark Court, Davy Avenue, Knowlhill, Milton Keynes MK5 8PP, United Kingdom and should be returned immediately upon request.
To check its validity telephone +44 (0) 345 080 9000. An electronic certificate can be authenticated [online](#).

BSI Assurance UK Limited, registered in England under number 7805321 at 389 Chiswick High Road, London W4 4AL, UK.
A member of BSI Group of Companies.

Certificate



for European Product Safety

Reference No. 1719061

Sub-miniature fuse-link

Type designation 932 T3.15AL250V, 932 T5AL250V, 932 T8AL250V, 932 T10AL250V

Certificate holder **Dongguan Better Electronics Technology Co.
Ltd, Room601of16 Block, Xinzhu Yuan
No. 4, Xinzhu Road, Songshanlake
Hightech Ind. Devel. Zone Dongguan
City, Guangdong Province, 523808
CHINA**

*The product complies with
the standard(s)* EN 60127-3:2015

Date of expiry 2 November 2022

EU Directive information According to the principle of presumption of conformity, this certificate constitutes support for an EC Declaration of Conformity and CE marking according to the Low Voltage Directive 2014/35/EU.

Additional information in Appendix.

Certification Body Intertek Semko AB, Product Certification *Place* Kista - Stockholm

Signed 
Bo Berglöf *Date* 6 November 2017
Page 1 of 2

This certificate is issued in accordance with the terms and conditions set out in the Appendix.



**Intertek
Appendix**

Reference No. 1719061

Technical data

Type designation	932 T3.15AL250V, 932 T5AL250V, 932 T8AL250V, 932 T10AL250V			
Rated voltage (V)	250V			
Rated current (A)	3,15A	5A	8A	10A
Standard sheet	4			
Trademark:	ⓑ			
Product information	Sub-miniature fuse-link. Time-lag, Low-breaking capacity.			

Manufacturing site(s) Dongguan Better Electronics Technology Co.
Ltd., Nanmen Village, Hengkeng
Administrative Zone, Liaobu Town,
Dongguan, Guangdong, 523413
CHINA

According to the principle of presumption of conformity, this certificate, which includes production control, constitutes support for an EC Declaration of Conformity and CE marking according to the Low Voltage Directive 2014/35/EU.

This presumption can expire before end of validity of this certificate due to new issued Standard or Amendment and changes within the EU legislation.

This certificate is based on CB with ref. No. CN40983 dated 17 August 2017, issued by CQC.

This certificate replaces previously issued ref. No. 1717501 dated 2 November 2017.

A new certificate has been issued on account of correction of the manufacturing site address.

Certification Body Intertek Semko AB, Product Certification *Place* Kista - Stockholm

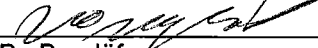
Signed 
Bo Berglöf *Date* 6 November 2017

This Certificate is for the exclusive use of Intertek's Client and is provided pursuant to the Certification agreement between Intertek and its Client. Intertek's responsibility and liability are limited to the terms and conditions of the agreement. Intertek assumes no liability to any party, other than to the Client in accordance with the agreement, for any loss, expense or damage occasioned by the use of this certificate. Only the Client is authorized to permit copying or distribution of this certificate and then only in its entirety. Use of Intertek's Certification mark is restricted to the conditions laid out in the agreement. Any further use of the Intertek name for the sale or advertisement of the tested material, product or service must first be approved in writing by Intertek. Initial Factory Assessments and Follow up Services are for the purpose of assuring appropriate usage of the Certification mark in accordance with the agreement, they are not for the purposes of production quality control and do not relieve the Client of their obligations in this respect.

ASF