

# canfield connector

## Quality is our goal.

Canfield Connector is a manufacturer of interconnection devices, electronic timers, modules and specialty electronic devices targeted at the fluid power industry. Our *Complete Quality Control Program* (CQCP) protects our customers by assuring them of 100% test and inspection prior to shipment of all items produced at Canfield Connector. Most items are tested during the manufacturing process and again during final inspection, making our products double or triple tested for function prior to shipment. Our Quality Policy at Canfield Industries is: Total Customer Satisfaction Through Unmatched Quality, Products, Service, and Integrity. Our Quality Objectives are Customer Satisfaction, On-Time Delivery, Sales and Profit Growth, High Quality Products, and Superior Supplier Performance. Canfield Connector operations have been certified to the ISO 9001 With Design International Quality System Standard.

## 1 year warranty

All products manufactured by Canfield Connector are warranted by Canfield Connector to be free of defects in material and workmanship for a period of one year from the purchase date. Canfield Connector's obligation under this warranty is limited to repair or replacement of the defective product or refund of the purchase price paid solely at the discretion of Canfield Connector and provided such defective product is returned to Canfield Connector freight prepaid and upon examination by Canfield Connector such product is found defective. This warranty shall be void in the event that the product has been subject to misuse, misapplication, improper maintenance, or tampering. This warranty is expressed in lieu of all other warranties, expressed or implied from Canfield Connector representatives or employees.

## Technical assistance

Our trained technical staff is available at (330) 758-8299 or 1-800-554-5071 to help you with your questions concerning Canfield products. All questions are welcome. We are constantly developing new product lines and custom products for different applications. Ask our sales representative for more details.



## Ordering made easy

Our order desk is open 8:00 AM to 5:00 PM EST Monday through Friday. Call us at (330) 758-8299 or 1-800-554-5071 to place your order or fax us at (330) 758-8912.

## Designs and published data

All designs and specifications are subject to change without notice. Such changes are not to be considered retroactive, and seller assumes no responsibility for revision of models already in the field. All data is sufficiently accurate for general use, but seller assumes no responsibility for errors or omissions. Certified prints are available on request, at a reasonable charge.



**MADE IN USA**



*\*DISCLAIMER: Product changes including specifications, features, designs, and availability are subject to change anytime without notice. For critical dimensions or specifications, contact factory.*

Certified To  
ISO 9001  
With Design



05.096.1

# STANDARD TERMS OF SALE AND RESTOCKING

## 1. GENERAL:

- a.) This contract contains the entire agreement between parties and supersedes any prior or contemporaneous oral or written agreements or communications between them relating to the subject matter hereof.
- b.) This contract may not be assigned, modified or cancelled without Seller's prior written consent, and any attempt to assign, modify or cancel it without consent shall be absolutely void.
- c.) No delay or omission to exercise any right, power or remedy accruing to Seller upon breach or default by Buyer under this contract shall impair any such right, power or remedy of Seller, or shall be construed as a waiver of any such breach or default. All waivers must be in writing.
- d.) In the event of any of the provisions hereof shall, for any reason, be held void or unenforceable, the remaining provisions shall remain in full force and effect and shall control.
- e.) Any provisions of this contract prohibited by law of any state shall as to said state, be ineffective to the extent of such prohibition without invalidating the remaining provisions of this contract.
- f.) This contract shall be governed by and construed in accordance with the laws of the State of Ohio, excluding however, Ohio law pertaining to conflicts of law.

## 2. SELLER'S LIMITED WARRANTY AND LIMITATIONS OF LIABILITIES:

All goods sold hereunder are warranted to be free from defects in material and workmanship for a period of one (1) year from the date of manufacture unless otherwise agreed upon in writing, and to conform to applicable specifications, drawings, blueprints and/or samples. These express warranties are in lieu of and exclude all other warranties, express or implied. Seller's sole obligation under these warranties shall be to issue credit, repair, or replace any item or part thereof which is proved to be other than as warranted; no allowance shall be made for any labor charges of Buyer for replacement of parts, adjustment or repairs, or any other work, unless such charges are authorized in advance by Seller. If goods are claimed to be defective in material or workmanship or not to conform to specifications, drawings, blueprints and/or samples, Seller upon notice promptly given will either examine the goods at their site, or issue shipping instructions for return to Seller (transportation costs prepaid by Buyer). In the event any goods are proved to be other than as warranted, transportation costs to and from Seller's plant will be borne by Seller and reimbursement or credit will be made for amounts so expended by Buyer. In particular, seller makes no warranty respecting the merchantability of the products or their suitability or fitness for any particular purpose or use or respecting infringement. These warranties shall not extend to any goods or parts thereof which have been subjected to misuse or neglect, damage by accident, rendered defective by reason of improper installation or by the performance of repairs or alterations outside of Seller's plant except when performed under Seller's specific authority. These warranties shall not apply to any goods or parts thereof furnished by Buyer or acquired from others at Buyer's request and/or to Buyer's specifications. BUYER SHALL NOT IN ANY EVENT BE ENTITLED TO, AND SELLER SHALL NOT BE LIABLE FOR INDIRECT, SPECIAL, INCIDENTAL OR CONSEQUENTIAL DAMAGES OF ANY NATURE INCLUDING, WITHOUT BEING LIMITED TO, LOSS OF PROFIT, LOSS OF DATA, LOSS OF USE, PROMOTIONAL OR MANUFACTURING EXPENSES, OVERHEAD, INJURY TO REPUTATION OR LOSS OF CUSTOMERS. BUYER'S RECOVERY FROM SELLER FOR ANY CLAIM SHALL NOT EXCEED BUYER'S PURCHASE PRICE FOR THE PRODUCTS IRRESPECTIVE OF THE NATURE OF THE CLAIM, WHETHER IN CONTRACT, TORT, WARRANTY, OR OTHERWISE.

## 3. PAYMENT:

- a.) Checks are accepted subject to collection and the date of collection shall be deemed the date of payment. Any check received from Buyer may be applied by Seller against any obligation owing by Buyer to Seller, under this or any other contract, regardless of any statement appearing on or referring to such check, without discharging Buyer's liability for any additional amounts owing by Buyer to Seller; and the acceptance by Seller of such check shall not constitute a waiver of Seller's right to pursue the collection of any remaining balance.
- b.) On any invoice not paid by maturity date (net thirty (30) days), Buyer shall pay interest from maturity to date of payment at the annual percentage rate of 18% (or such lower rate as may be the maximum allowable by law), together with Seller's costs of collection (including reasonable attorneys' fees).
- c.) Buyer agrees to pay the entire net amount of each invoice rendered by Seller pursuant to the terms of each such invoice without offset or deduction.
- d.) Prices for any undeliverable Products may be increased by Seller in the event of any increase in Seller's cost of supplies, raw materials, labor or services, or any increase in Seller's cost resulting from government action or other cause beyond Seller's control.

## 4. CREDIT:

Seller may in its sole discretion at any time and from time to time change the terms of Buyer's credit, require payment in cash before shipment of any or all of the Products specified herein, and/or require anticipated payment of any or all amounts due or to become due under this contract. If Seller believes in good faith that Buyer's ability to make payments called for by this contract is or may be impaired, Seller may cancel this contract or any remaining balance thereof, Buyer remaining liable to pay for any Products already shipped.

## 5. TAXES/FREIGHT:

Unless otherwise agreed in writing, the amount of all transportation charges from Seller's location and all taxes or other charges now or hereafter imposed by any government authority upon sale, purchase, resale, delivery, manufacture, production or possession of the Products specified herein, which may be paid by Seller or for which Seller may be liable, shall be paid to Seller by Buyer in addition to the purchase price of the Products.

## 6. ORDERS:

- a.) Each order for Products is subject to acceptance in writing by Seller.
- b.) Orders may not be cancelled or rescheduled after delivery by Seller to the carrier. In the event of allocation of Products, orders that are accepted by Seller will be accepted using a fair schedule method.
- c.) Special Orders - Special orders for items not normally stocked are non-cancelable and non-returnable.

## 7. DELIVERIES/TITLE:

- a.) All goods shall be packed in suitable containers for protection in shipment and storage. No special charges for packing or crating shall be made unless specifically listed as an additional and separate charge on Seller's quotation or acceptance of Buyer's order.
- b.) Subject to Seller's right of stoppage in transit, delivery of the Products to a carrier shall constitute delivery to Buyer, and risk of loss shall thereupon pass to Buyer; however, title shall remain in Seller until Buyer makes payment in full under contract. Products invoiced and held by Seller for any reason shall be at Buyer's risk and expense. Delivery route shall be the election of Seller unless specifically designated by Buyer.

- c.) Delivery of any installment of Products within 30 days after the date specified therefor shall constitute a timely delivery. Thereafter, delivery shall be deemed timely unless prior to shipment Seller has received written notice of cancellation. Delivery of a quantity which does not vary by more than 10% from the quantity specified therefor shall constitute full performance of such delivery. Delay in delivery of one installment shall entitle Buyer to cancel that installment only.
- d.) Should delivery of all or part of the Products specified herein (or any other obligation of Seller) be delayed by events beyond Seller's control, Seller's time for performance shall be extended by the period of delay, or Seller may, at its option, cancel this contract without liability, Buyer remaining liable for shipments already made. Sellers shall not be liable for any delays in or failures of delivery due to acts of God or public authority, labor disturbances, accidents, fires, floods, extreme weather conditions, failures of and delays by carriers, shortages of material, delays of a supplier due to causes beyond its control.
- e.) Buyer is deemed to have accepted the Products unless notice of rejection is given within a reasonable time, which is agreed to be within seven (7) days after receipt. Buyer waives any right to revoke acceptance thereafter.
- f.) No return of Products will be accepted by Seller without a return materials authorization number (RMA#), which will be issued in Seller's sole discretion. Returned Products must be in original shipping cartons, and must be freight prepaid. In the event any goods are proved to be other than as warranted, transportation costs to and from Seller's plant will be borne by Seller and reimbursement or credit will be made for amounts so expended by Buyer. Notice of defective Products must be made within seven (7) calendar days of receipt. A complete description regarding the nature of the defect must be included with all returned Products. All items not eligible for credit will be returned to Buyer, transportation collect.

## 8. SPECIFICATIONS AND DESIGNS:

- a.) Should Buyer request that changes be made in the specifications or design relating to any goods, delivery dates and schedules shall be revised accordingly, if necessary, and an equitable adjustment, upward or downward, shall be made in price in so far as warranted.
- b.) Any designs, tools, patterns, material, drawings, information or equipment furnished by Buyer, or any special tools made or acquired for the Buyer by the Seller which becomes Buyer's property, shall be used only in the production of the goods called for herein and not otherwise, unless by Buyer's written consent. Seller agrees to exercise reasonable care with respect to such property and equipment while in its possession and control, but shall not be responsible for loss or damage occurring without its fault or negligence or for ordinary wear and tear.

## 9. USE OF PRODUCTS:

- a.) If technical advice is offered or given in connection with the use of any Products it will be as an accommodation to Buyer and without charge and Seller shall have no responsibilities or liabilities whatsoever for the content or use of such advice.
- b.) Products sold by Seller are not designed for use in life support or nuclear applications. Seller's customers using or selling Products for use in life support or nuclear applications do so at their own risk, agree that Seller and the Manufacturer of Products are not liable, in whole or in part, for any claim or damage arising from such use, and agree to fully indemnify Seller and the Manufacturer from and against any and all damages, loss, cost, expense or liability arising out of or in connection with the use or performance of Products in life support or nuclear applications.
- c.) Should the Buyer notify the Seller that its order is placed under a prime contract with an agency of the United States Government, the following terms and conditions shall be incorporated into Seller's terms of sale in so far as the Buyer is required to incorporate such provisions in its purchase orders or subcontracts of terms in so far as applicable to the goods sold hereunder.
- d.) The following clause set forth or referred to in Sections 7 and 12 of the Armed Services Procurement Regulations are hereby incorporated by reference: Renegotiation (7-103.13), Eight Hour Law of 1912 (7-103.16 12-303.1), Walsh-Healy Public Contracts Act (7-103.17 12-604), Nondiscrimination in Employment (7-103.18 12-802), Officials Not to Benefit (7-103.19), Buy American Act (7-104.3 6-104.5), Notice to the Government of Labor Disputes (7-104.4), Excess Profit (7-104.11), Military Security Requirements (7-104.12), Examination of Records (7-104.15), Convict Labor (7-104.17 12-203). In order to make the context of the above clauses applicable to these terms of sale, the word "Buyer" shall be substituted for the word "Government" and the word "Seller" shall be substituted for the word "contractor" whenever necessary.
- e.) Unless the design for the goods shall have been furnished by the Buyer to the Seller and used by the Seller in manufacturing the goods, Seller shall defend and save harmless the Buyer from any claim that any product or article sold to the Buyer hereunder in and of itself infringes any United States letters patent by reason of its sale or use/ provided Seller is notified in writing within ten (10) days after any such claim is made against the Buyer, and provided further that Seller is permitted to defend the same in Buyer's name if action be brought. If the product or article sold to the Buyer hereunder is manufactured by the Seller according to a design furnished by the Buyer, the Buyer will defend and save harmless the Seller from any claims of infringement of any United States Letters patent.

## 10. TOOLING:

Tool, die, and pattern charges, if any, are in addition to the price of the Goods and are due and payable upon completion of the tooling. All such tools, dies and patterns shall be and remain the property of Seller. Charges for tools, dies, and patterns do not convey to Buyer, title, ownership interest in, or rights to possession or removal, or prevent their use by Seller for other purchasers, except as otherwise expressly provided by Seller and Buyer in writing with reference to this provision.

## 11. INSTALLATION/TRAINING:

Buyer acknowledges that no installation, training or education is contracted for or purchased under terms of this contract unless specifically agreed in writing. In the event that Buyer receives any training from Seller with respect to the Products, then, in that event, such training is personal to the persons receiving such training, and Buyer acknowledges that any persons receiving such training may not be capable of operating the Products.

## 12. RESTOCKING POLICY:

Merchandise that is returned must be accompanied by pre-approved return materials authorization number (RMA#). Return authorizations will be approved by Canfield Connector. When materials are received, an inspection will be performed to determine if restocking charges are applicable. Material that does not have an authorization will be returned to the purchaser at their expense. RETURNED ITEMS MAY ENTAIL A RESTOCKING CHARGE. CONSULT FACTORY FOR EXACT RESTOCKING FEES. AS CHARGES MAY VARY DEPENDING ON THE AMOUNT OF SPECIALTY OF THE ITEMS BEING RETURNED. CUSTOM PARTS & "9" NUMBERS ARE NON-RETURNABLE AND NON-REFUNDABLE (EXCEPT IN CASES OF WARRANTY)

# Canfield Connector Buyer's Guide

## Table of Contents

<i>page</i>	<b>SOLENOID VALVE CONNECTORS</b>	
4	Series 5000	General Line Solenoid Valve Connectors
6	Series 5000 ISO	ISO Solenoid Valve Connectors
8	Series 5000 MINI	MINI Solenoid Valve Connectors
10	Series 5000 Sub-Micro	Sub-Micro Solenoid Valve Connectors
12	Series 5F	Molded Solenoid Valve Connectors
14	Series 5J	Molded Solenoid Valve Connectors
16	Series 5FR	Rectified Molded Solenoid Valve Connectors
18	Series 5JR	Rectified Molded Solenoid Valve Connectors
20	Series 5FFAC	Fieldbus Adapter Solenoid Valve Connectors
22	Series 5JFAC	Fieldbus Adapter Solenoid Valve Connectors
24	Series R5000	Rectified Solenoid Valve Connectors
26	Series D5400	Micro Solenoid Driver (MSD)
28	Series P5600	Solenoid Valve Connectors with Surge Suppression
31	Series FAC	Round Connector to Solenoid Valve Adapter Connectors
33	Series iLW	Interposed Lighted Wafers for Connectors
34	Series M5	Male Connectors
38	Model MCCR	Multiple Control Connector
40	CanTop	Cord Grips
42	DCP	DIN Coil Protectors
<b>TIMERS, PROPORTIONAL AND ELECTRONIC CIRCUITS</b>		
43	Series 5800	Micro Logic Timer (MLT) Connector
47	Series 5950	Micro Proportional Driver (MPD)
49	Series B5950	Block-Style Micro Proportional Driver
51	Sandwich CRT	Sandwich-Style Condensation Removal Timer
53	Series EOS	End of Stroke Pneumatic & Hydraulic Sensor
57	Series EOS 2	Block-Style End of Stroke Pneumatic & Hydraulic Sensor
59	Model MBT	Multifunction Block Timer
<b>CYLINDER PROXIMITY SENSORS AND ACCESSORIES</b>		
64	Series 7000	Reed & Electronic Magnetic Sensors
66	Series 7HL	Reed Switch for Hazardous Location
67	Series 7GL	General Location Magnetic Sensors
68	Series 8000	Reed & Electronic Magnetic Sensors
71	Series 8D	Reed & Electronic Magnetic Sensors
73	Series 8E	Reed & Electronic Magnetic Sensors
75	Series 8WS	Reed & Electronic Sensor for 12mm Dovetail Applications
77	Series 9C	Reed & Electronic Sensor for Round Keyway Applications
79	Series 9D	Reed & Electronic Sensor for Universal Applications
82	Series 9E	Reed & Electronic Sensor for Universal Applications
85	Series 9F	Reed & Electronic Sensor for 4mm "T" Slot Applications
87	Series 9G	Reed & Electronic Sensor for 6.3mm "T" Slot Applications
89	Series 9H	Reed & Electronic Sensor for 4.2mm "T" Slot Applications
91	Series 9M50	Reed & Electronic Sensor for 6.5mm Groove Applications
93	Series 9N	Reed & Electronic Sensor for 4.25mm Round Groove Applications
95	Series 9T	Reed & Electronic Sensor for 7.2mm "T" Slot Applications
<b>ROUND CONNECTORS</b>		
97	B-Type	Quick Connect/Disconnect Round Sensor Connectors
<b>CONVEYOR CONTROLS</b>		
99	OSV	Optical Sensor Valve Photo-Eye Accumulation System
<b>APPENDIX</b>		
102	Wire Installation	
103	Wire Terminology	
104	OHMS Law	
105	Environmental Protection Classifications	
106	Units and Conversions	
107	Glossary of Terms	

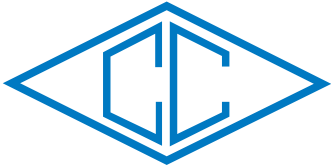

## canfield connector

8510 Foxwood Court  
Youngstown, Ohio 44514  
(330) 758-8299 Fax: (330) 758-8912  
www.canfieldconnector.com

### SERIES 5000

### SOLENOID VALVE CONNECTORS GENERAL PRODUCT OVERVIEW

#### General Description

The ISO and 8mm Sub-Micro connectors are made according to DIN 43650 / ISO 4400, EN175301-803:2000. The MINI and 9.4mm Sub-Micro connectors are industry standards. All are used as protective enclosures for electrical connection in conjunction with hydraulic and pneumatic solenoid valves. These connectors offer distinct advantages over "hardwired" solenoid valves because of their modular design. Used where rapid installation and service are a must. Better than molded construction when special wire is needed or when using one long wire run.

#### Dimensional Data

ALL DIMENSIONS ARE IN MILLIMETERS UNLESS OTHERWISE NOTED (COMPLETE DIMENSIONAL INFORMATION IS PROVIDED ON INDIVIDUAL PAGES)

<b>MINI</b>	<b>ISO</b> DIN 43650 Form "A" / ISO 4400, EN175301-803:2000	<b>Sub-Micro</b> (8mm) DIN 43650 Form "C" / ISO 4400, EN175301-803:2000
<p><b>PG9</b></p>	<p><b>PG9 / HT PG9</b></p>	<p><b>8mm Strain Relief</b> *Ground spade offset by 0.2mm toward pin 1.</p>
<p><b>3/8" Conduit</b></p>	<p><b>PG11 / HT PG11</b></p>	<p><b>8mm 1/2" Conduit</b> *Ground spade offset by 0.2mm toward pin 1.</p>
<p><b>1/2" Conduit</b></p>	<p><b>1/2" Conduit</b></p>	<p><b>9.4mm Strain Relief</b></p>
<p><b>1/2" Conduit</b></p>	<p><b>HT 1/2" Conduit</b></p>	<p><b>9.4mm 1/2" Conduit</b></p>

## Ordering Information

Use a prefix of "G" for Individually Bagged

5 □ 0 □ - □ □ □ □ □ 0 0

**Orientation**  
 1 - Ground down  
 Other ground orientations available.  
 Please consult factory.

**Lighting Specification**  
 0 - Unlighted  
 3 - 6 - 48V AC/DC 50/60 Hz  
 7 - 48 - 120 VDC  
 100 - 240 VAC 50/60 Hz

**Gasket**  
 1 - Nitrile  
 2 - Silicone  
 3 - Nitrile profile\*\*

**Housing Color**  
 0 - Standard "B"  
 1 - Gray "A"

**Contacts**  
 0 - 2+ ground  
 1 - 3+ ground\*

**Connector Types**  
 01 - MINI strain relief PG9  
 02 - MINI 3/8" conduit  
 03 - MINI 1/2" conduit  
 08 - ISO strain relief PG9  
 09 - ISO strain relief PG11  
 10 - ISO 1/2" conduit  
 11 - ISO HT strain relief PG9†  
 12 - ISO HT strain relief PG11†  
 13 - ISO HT 1/2" conduit†  
 90 - Sub-Micro PG7 DIN interface (8mm)  
 91 - Sub-Micro 1/2" conduit interface (8mm)  
 95 - Sub-Micro 1/2" conduit (9.4mm)  
 99 - Sub-Micro strain relief PG7 (9.4mm)

Each connector kit contains fastening hardware and gasket assembly.

\* NOT Available in MINI  
 \*\*NOT Available in Sub-Micro

Not all combinations are available. Consult factory for details.

† High Top Housing for easy wiring.

NOTE: When using MAC Valves with 9.4mm Sub-Micro, consult our factory.  
 MAC is the registered trademark of MAC Valves, Inc.

### Ordering Example:

5100-1010000

Ground down, unlighted, nitrile gasket, MINI strain relief PG9 connector, 2+ ground contacts, standard house

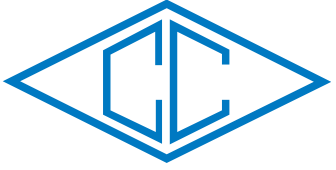

**canfield connector**  
 8510 Foxwood Court  
 Youngstown, Ohio 44514  
 (330) 758-8299 Fax: (330) 758-8912  
 www.canfieldconnector.com

**SERIES 5000**

**ISO  
SOLENOID VALVE CONNECTOR**

**General Description**

Canfield Connector's Series 5000 ISO connector connects solenoid valves using the DIN 43650 Form "A" / ISO 4400, EN175301-803:2000 specification. This standard permits industry interchangeability and has been embraced by the solenoid valve industry worldwide. Features include the ability for the user to wire the connector into existing installations or the connector can be prewired at the factory. Wire connections are made inside the connector housing and the wire inlet is either PG9, PG11 or 1/2" conduit. Canfield has added to this line with the HT (High Top) housing. The HT accommodates the user with more room for larger wire diameters. The standard ISO connectors are still available for those applications with space constraints. Maximum current rating is 10 Amps with a maximum conductor size of 14 AWG with an outer jacket not to exceed .410 inches diameter. There are CSA approved versions as well as versions with indicator lights depicting the "on" state. The connectors are NEMA 4 and IP 65 environment rated.



**Dimensional Data**

ALL DIMENSIONS ARE IN MILLIMETERS UNLESS OTHERWISE NOTED

**Wiring Information**

<i>PG9 / PG11</i>	<i>HT** PG9 / PG11</i>
<i>1/2" Conduit</i>	<i>HT** 1/2" Conduit</i>

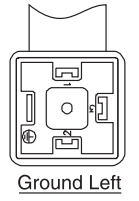
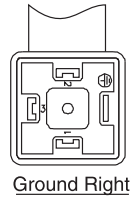
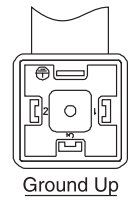
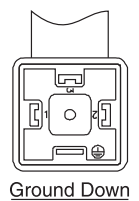

Normal polarity: 1 = (+) Positive, High  
 2 = (-) Negative, Neutral  
 = Chassis Ground

\*\*HT refers to High Top - Larger connector for larger wire gauge and easy installation.

## Technical Data

- The cable outlet can be assembled in 90° increments
- Color: black, gray or translucent for lighted styles
- Cable diameter: PG9 - .236 to .315 inches O.D.  
PG11 - .315 to .394 inches O.D.  
1/2" Conduit - .410 inches max.
- Cross section of the conductor wire max.: 14 AWG
- Maximum approved current: 10 Amps
- Rated voltage max.: 300 VDC / 250 VAC 50/60 Hz
- No. of contacts: 2+ ground  
3+ ground
- Environmental protection: NEMA 4 and IP 65 dust tight and water resistant
- Maximum rated temperatures for gaskets:  
Nitrile gasket: -25° to +90°C  
Silicone gasket: -40° to +125°C

## Derating Curve

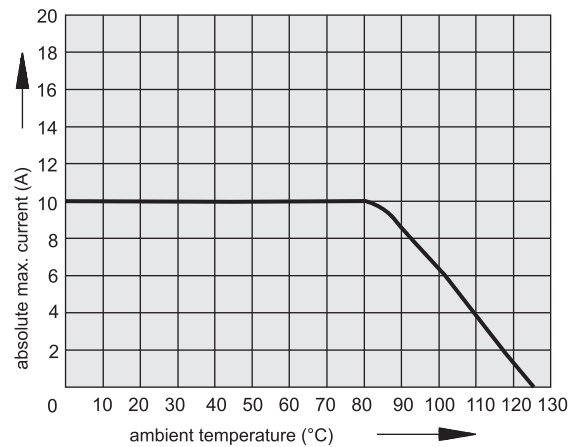

## Ordering Information

Use a prefix of "G" for Individually Bagged

5 0 - - - - - 0 0

**Orientation**  
1 - Ground down  
Other ground orientations available.  
Please consult factory.

**Lighting Specification**  
0 - Unlighted  
3 - 6 - 48V AC/DC 50/60 Hz  
7 - 48 - 120 VDC  
100 - 240 VAC 50/60 Hz

**Gasket**  
1 - Nitrile  
2 - Silicone  
3 - Nitrile profile

**Connector Type**  
08 - ISO strain relief PG9  
09 - ISO strain relief PG11  
10 - ISO 1/2" conduit  
11 - ISO HT strain relief PG9\*\*  
12 - ISO HT strain relief PG11\*\*  
13 - ISO HT 1/2" conduit

**Housing Color**  
0 - Black "B" standard. Translucent if lighted.  
1 - Gray "A"

**Contacts**  
0 - 2 + ground  
1 - 3 + ground

\*\*HT refers to High Top - Larger connector for larger wire gauge and easy installation.

Each connector kit contains fastening hardware and gasket assembly.

SERIES 5000 ISO	
Can-Pak Part Number	Qty
CP-5100-1080000-025	25
CP-5100-1080000-100	100
CP-5100-1100000-025	25
CP-5100-1100000-100	100
CP-5103-1080000-025	25
CP-5103-1080000-100	100
CP-5107-1080000-025	25
CP-5107-1080000-100	100

### Ordering Example:

5100-1080000

Ground down, nitrile gasket, ISO strain relief PG9, 2+ ground contacts, black house

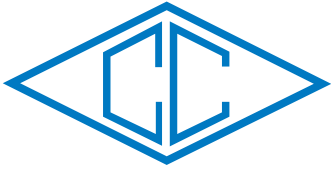

**canfield connector**  
 8510 Foxwood Court  
 Youngstown, Ohio 44514  
 (330) 758-8299 Fax: (330) 758-8912  
 www.canfieldconnector.com

**SERIES 5000**

**MINI  
 SOLENOID VALVE CONNECTOR**

**General Description**

The Canfield Connector field wireable MINI solenoid valve connector is a high quality interconnection device for use with solenoid valves and pressure switches. The connector features a PG9 strain relief, 3/8" or 1/2" conduit wire pass through, all with screw terminals for wire connections. The MINI accommodates wire from .240" to .410" diameter as a standard with an AWG of 14 maximum. Environment resistance of NEMA 4 / IP 65 along with versions which are CSA approved ensure long trouble free service. Current maximum of 10 Amps and the temperature rating of -40° to +125°C encompasses most applications. The interface is an industry standard.



**Dimensional Data**

ALL DIMENSIONS ARE IN MILLIMETERS UNLESS OTHERWISE NOTED

Strain Relief	3/8" Conduit	1/2" Conduit

**Wiring Information**



Ground Up

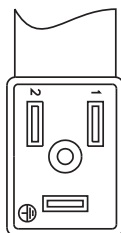

Ground Down

Normal polarity: 1 = (+) Positive, High  
 2 = (-) Negative, Neutral  
 = Chassis Ground



**Technical Data**

- The cable outlet can be assembled in 180° increments
- Color: black, gray or translucent for lighted styles
- Cable diameter: PG9 - .236 to .315 inches O.D.  
3/8" & 1/2" Conduit - .410 inches max.
- Cross section of the conductor wire max.: 14 AWG
- Rated voltage max.: 300 VDC / 250 VAC 50/60 Hz
- Maximum approved current: 10 Amps
- No. of contacts: 2+ ground
- Environmental protection: NEMA 4 and IP 65 dust tight and water resistant
- Maximum rated temperatures for gaskets:  
Nitrile gasket -25° to +90°C  
Silicone gasket -40° to +125°C

**Derating Curve**

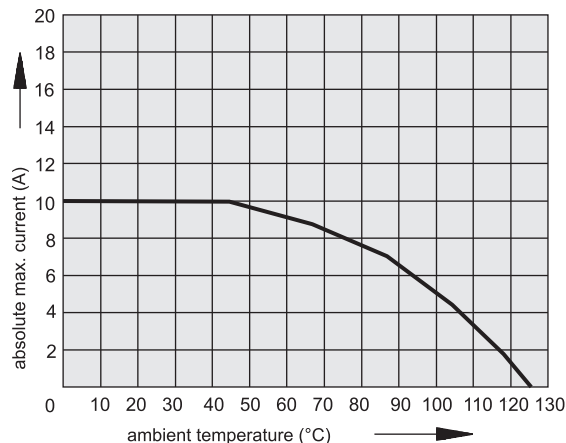

5000 MINI

**Ordering Information**

Use a prefix of "G" for Individually Bagged

5 □ 0 □ - □ □ □ 0 □ 0 0

**Orientation**  
1 - Ground down  
Other ground orientations available.  
Please consult factory.

**Lighting Specification**  
0 - Unlighted  
3 - 6 - 48V AC/DC 50/60 Hz  
7 - 48 - 120 VDC  
100 - 240 VAC 50/60 Hz

**Gasket**  
1 - Nitrile  
2 - Silicone  
3 - Nitrile profile

**Connector Types**  
01 - MINI strain relief PG9  
02 - MINI 3/8" conduit  
03 - MINI 1/2" conduit

**Housing Color**  
0 - Black "B" standard. Translucent if lighted.  
1 - Gray "A"

<b>SERIES 5000 MINI</b>	
Can-Pak Part Number	Qty
CP-5100-1010000-025	25
CP-5100-1010000-100	100
CP-5100-1030000-025	25
CP-5100-1030000-100	100
CP-5103-1010000-025	25
CP-5103-1010000-100	100
CP-5107-1010000-025	25
CP-5107-1010000-100	100
CP-5163-1010000-010	10
CP-5163-1010000-050	50
CP-5167-1010000-010	10
CP-5167-1010000-050	50

Each connector kit contains fastening hardware and gasket assembly.

**Ordering Example:**

5100-1010000

Ground down, unlighted, nitrile gasket, MINI strain relief PG9 connector, black house

Consult factory for available versions listed by Canadian Standards Association for use with certified electrical equipment.

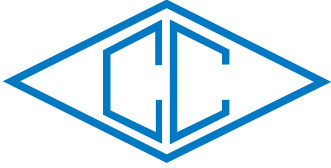

**canfield connector**  
 8510 Foxwood Court  
 Youngstown, Ohio 44514  
 (330) 758-8299 Fax: (330) 758-8912  
 www.canfieldconnector.com

**SERIES 5000**

**SUB-MICRO  
 SOLENOID VALVE CONNECTOR**

**General Description**

Canfield Connector's Series 5000 Sub-Micro connector is made to connect solenoid valves using the DIN 43650 Form "C", EN175301-803:2000 (8mm pin center) and the industry standard 9.4mm pin center. These standards permit industry interchangeability and have been embraced by the solenoid valve industry worldwide. Features include the ability for the user to wire the connector into existing installations or the connector can be prewired at the factory. Wire connections are made inside the connector housing. The wire inlet is either PG7 or 1/2" conduit. Maximum current rating is 6 amps with a maximum conductor size of 20 gauge with an outer jacket not to exceed .260 inches diameter. There are versions with indicator lights depicting the "on" state. The connectors are NEMA 4 and IP 65 environment rated.



**Dimensional Data**

ALL DIMENSIONS ARE IN MILLIMETERS UNLESS OTHERWISE NOTED

**Wiring Information**

<i>PG7, 8mm center</i>	<i>PG7, 9.4mm center</i>
<i>1/2" Conduit, 8mm center</i>	<i>1/2" Conduit, 9.4mm center</i>

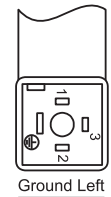
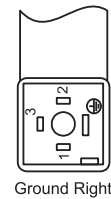

Normal polarity: 1 = (+) Positive, High  
 2 = (-) Negative, Neutral  
 = Chassis Ground

\*Ground spade offset by 0.2mm toward pin 1.

## Technical Data

- The cable outlet can be assembled in 90° increments
- Color: black, gray or translucent for lighted styles
- Cable diameter: PG7 - .157 - .236 inch O.D.  
1/2" Conduit 8mm & 9.4mm - .250 inch max.
- Cross section of the conductor wire max.: 20 AWG
- Rated voltage max.: 250 VAC 50/60 Hz or VDC
- Maximum approved current: 6 Amps
- No. of contacts: 2+ ground,  
3+ ground (*NOT* available on lighted units)
- Environmental protection: NEMA 4 and IP 65 dust tight and water resistant
- Maximum rated temperatures for gaskets:  
Nitrile gasket: -25° to +90°C  
Silicone gasket: -40° to +125° C

NOTE: When using MAC Valves with 9.4mm Sub-Micro, consult our factory.

## Derating Curve

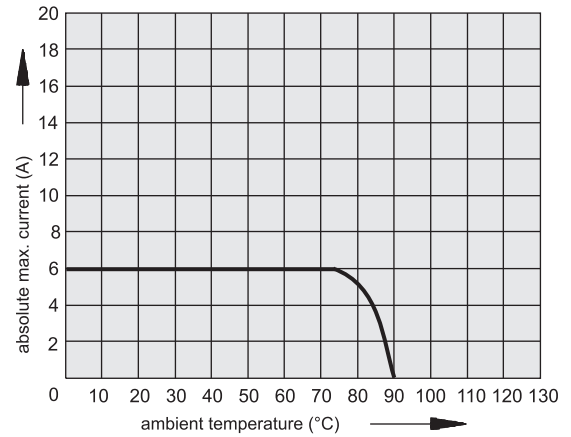

## Ordering Information

Use a prefix of "G" for Individually Bagged

5 0 - 0 0 0 0 0 0

### Orientation

1 - Ground down  
Other ground orientations available.  
Please consult factory.

### Lighting Specification

0 - Unlighted  
3 - 6 - 48V AC/DC 50/60 Hz  
7 - 48 - 120 VDC  
100 - 240 VAC 50/60 Hz

### Gasket

1 - Nitrile  
2 - Silicone

### Connector Type

90 - Sub-Micro strain relief PG7 DIN interface (8mm)  
91 - Sub-Micro 1/2" conduit DIN interface (8mm)  
95 - Sub-Micro 1/2" conduit (9.4mm)  
99 - Sub-Micro strain relief PG7 (9.4mm)

### Contacts

0 - 2 +ground  
1 - 3 +ground\*

### Housing Color

0 - Black "B" standard. Translucent if lighted.  
1 - Gray "A"



### SERIES 5000 SUB-MICRO

Can-Pak Part Number	Qty
CP-5100-1900000-025	25
CP-5100-1900000-100	100
CP-5100-1990000-025	25
CP-5100-1990000-100	100
CP-5103-1900000-025	25
CP-5103-1900000-100	100
CP-5103-1990000-025	25
CP-5103-1990000-100	100
CP-5107-1900000-025	25
CP-5107-1900000-100	100
CP-5107-1990000-025	25
CP-5107-1990000-100	100

\*3+ ground *NOT* available in lighted version.

Each connector kit contains screw, washer and gasket assembly.

### Ordering Example:

5100-1900000

Ground down, unlighted, nitrile gasket, Sub-Micro strain relief PG7 DIN interface, 2+ ground contacts, black house



Consult factory for available versions listed by Canadian Standards Association for use with certified electrical equipment.

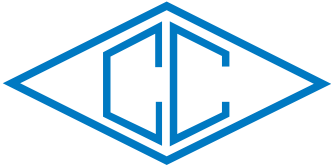

**canfield connector**  
 8510 Foxwood Court  
 Youngstown, Ohio 44514  
 (330) 758-8299 Fax: (330) 758-8912  
 www.canfieldconnector.com

5 F

**SERIES 5F**

**LIGHTED AND LOAD SUPPRESSED MOLDED MINI, ISO AND SUB-MICRO SOLENOID VALVE CONNECTORS**

**General Description**

The Canfield Series 5F all-molded DIN solenoid valve connector/gasket/cord assembly offers a completely molded design that is far better for environmental integrity than field wire versions. Made from rugged yet flexible polyurethane, the connector housing boasts high durability factors and application versatility. The low profile "straight-line" interface/cord configuration allows for installation in many limited space applications. The integrated gasket design boasts an IP67/NEMA 6 rating and makes it impossible to lose the gasket. The 5F and 5J are the only molded valve connectors in the industry that feature a HARD USAGE cord as a standard option in any length required, bi-directional indicator lights, and load suppression (not intended for UL 1449). UL and CSA versions are available as well. Canfield offers any version of the 5F connector with special wires including high flex, media compatible wire, special use wire, high temperature wire on request.



ISO shown above

**Dimensional Data**

**Technical Data**

ALL DIMENSIONS ARE IN MILLIMETERS UNLESS OTHERWISE NOTED

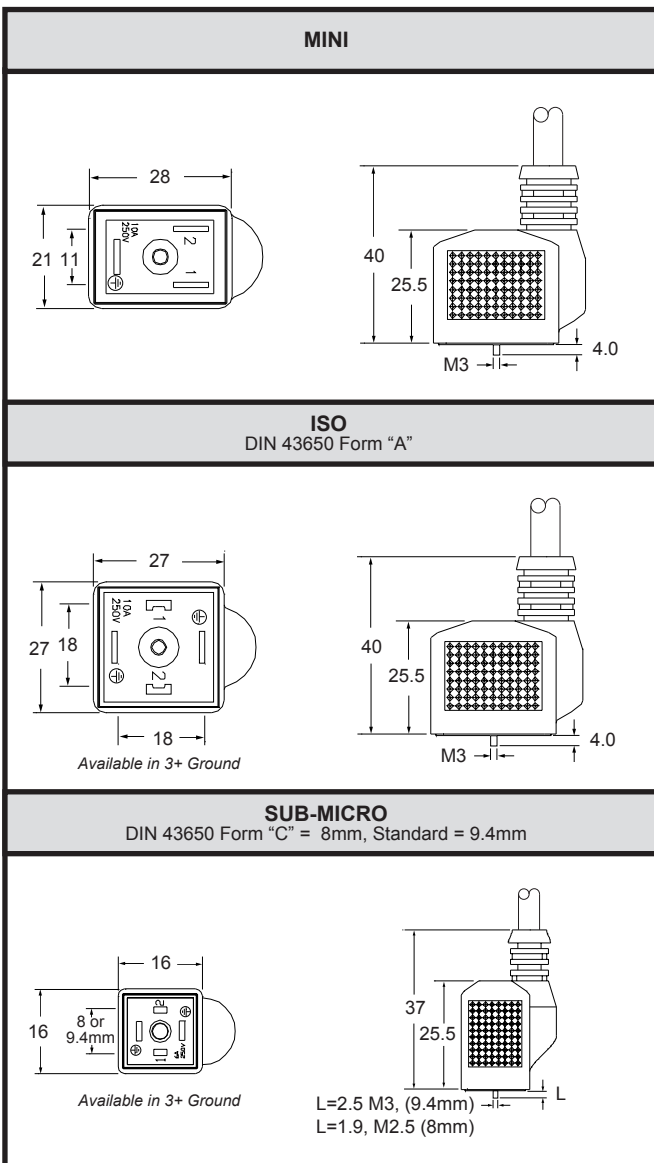

- Cable outlet: Molded construction with wire exiting out perpendicular to the face of the coil
- Available in no circuit, lighted and load suppressed version for all connectors
- Cable conductor colors:  
 European color code: Brown, blue, and yellow/green, (with 4<sup>th</sup> conductor version black)  
 US color code: White, black, and green, (with 4<sup>th</sup> conductor version red)  
 Specials on request
- Cable types: Pressure extruded PVC jacket  
 Hard Usage cordage  
 "S" type with SJTOW standard PVC jacket (ISO and Mini only)
- Cross section of conductor wire: 18 Gauge standard (ISO and Mini)  
 20 Gauge standard (Sub-Micro)
- Rated voltage max.: 250V AC 50/60 Hz, 300V DC
- Rated current max.: 10 Amps (ISO and Mini), 6 Amps (Sub-Micro)
- Enclosure and molded in gasket materials: Polyurethane
- Ambient rated temperatures: -25° to 80°C
- Environment protection: IP 67 and NEMA 6, dust tight and water resistant
- Available in four sizes:  
 DIN 43650 Form "A" (ISO), EN175301-803:2000  
 DIN Form "C" (Sub-Micro 8mm), EN175301-803:2000  
 Industry standard (Sub-Micro 9.4mm pin spacing)  
 Industry standard (Mini 11mm pin spacing)
- Pin configurations: For single solenoid valves - 2 connections plus ground – Mini, ISO, Sub-Micro 8mm and Sub-Micro 9.4mm

For pressure switches, double solenoid valves and other devices, 3 connections plus ground – ISO, Sub-Micro 8mm and 9.4mm

Note: Slight discoloration may occur to translucent material after prolonged exposure to UV rays.



Consult factory for available versions listed by Canadian Standards Association for use with certified electrical equipment.



Consult factory for available versions recognized under the Component Program of Underwriters Laboratories, Inc.

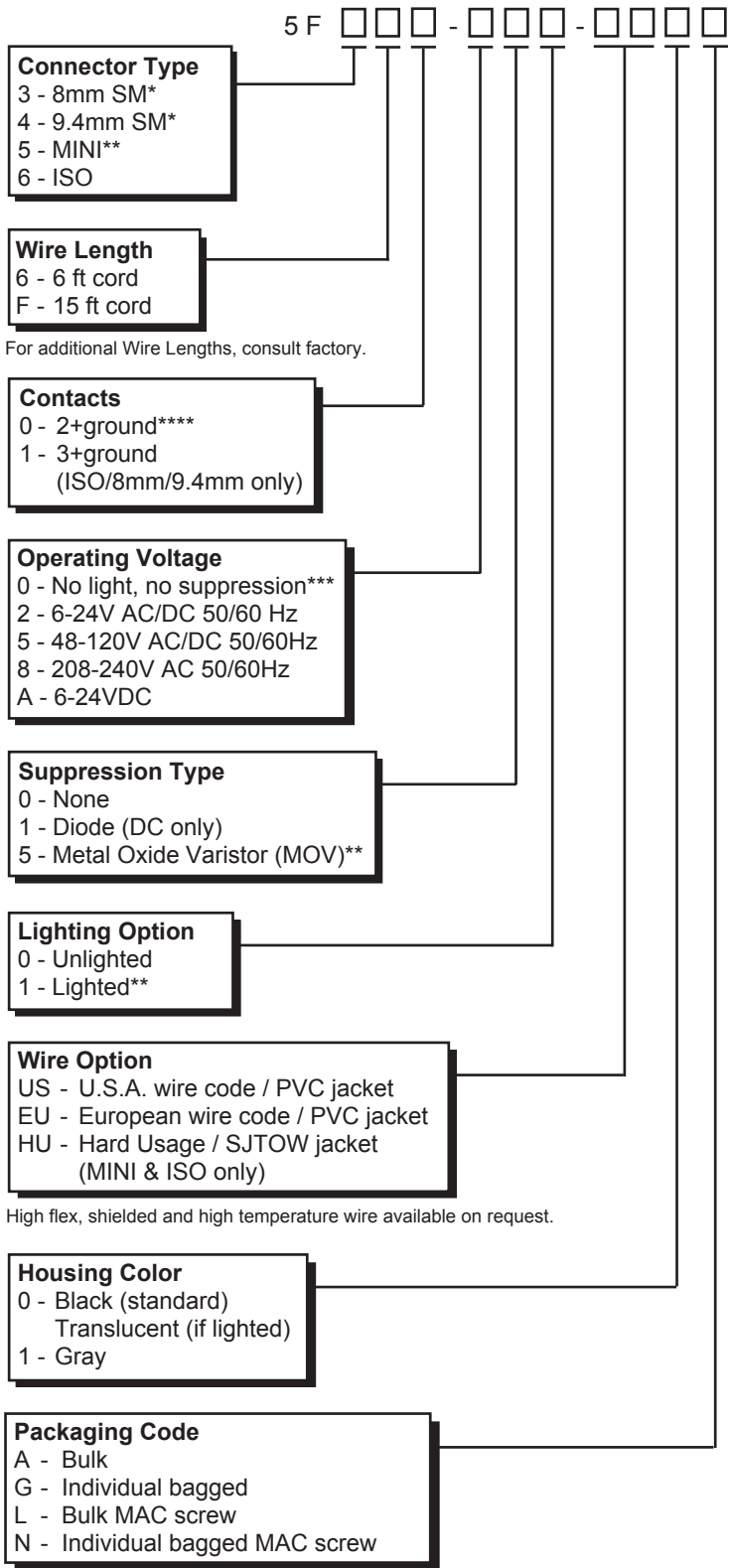

MAC is the registered trademark of MAC Valves, Inc.

All connectors come standard with integrated gasket.  
 \* 240 VAC voltage suppression and lighting not available.  
 \*\* NOT available in 3+ ground.  
 \*\*\* Rated 250V AC 50/60Hz, 300V DC.  
 \*\*\*\* ISO, Sub-Micro dual ground.

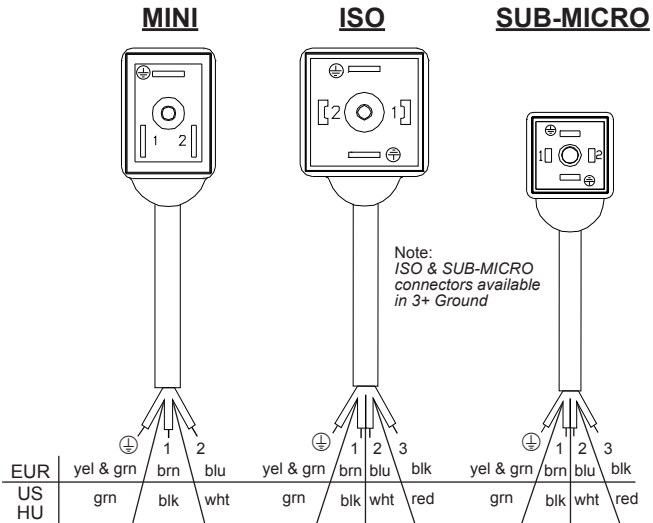

Normal polarity: 1 = (+) Positive, Hot  
 2 = (-) Negative, Neutral  
 ⊕ = Chassis Ground

For convenience and faster shipping, this series is available in Can-Paks.

**Accessories:**  
 WM-315 ISO/MINI Standard Wire Markers 10X Bag  
 WM-218 Sub-Micro Standard Wire Markers 10X Bag

Ordering Example:

5F360-250-US0A

8mm SM, 6 ft wire length, 2+ ground, 6-24V AC/DC 50/60 Hz, MOV, unlighted, U.S.A. wire code / PVC jacket, standard housing color, bulk

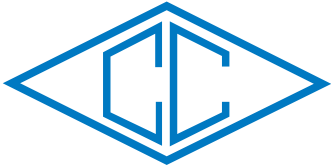

**canfield connector**  
 8510 Foxwood Court  
 Youngstown, Ohio 44514  
 (330) 758-8299 Fax: (330) 758-8912  
 www.canfieldconnector.com

5  
J

**SERIES 5J**

**LIGHTED AND LOAD SUPPRESSED MOLDED MINI, ISO AND SUB-MICRO SOLENOID VALVE CONNECTORS**

**General Description**

The Canfield Series 5J all-molded DIN solenoid valve connector/gasket/cord assembly offers a completely molded design that is far better for environmental integrity than field wire versions. Made from rugged yet flexible polyurethane, the connector housing boasts high durability factors and application versatility. The low profile "90°" interface/cord configuration allows for installation in many limited space applications. The integrated gasket design boasts an IP67/NEMA 6 rating and makes it impossible to lose the gasket. The 5J and 5F are the only molded valve connectors in the industry that feature a HARD USAGE cord as a standard option in any length required, bi-directional indicator lights, and load suppression (not intended for UL 1449). UL and CSA versions are available as well. Canfield offers any version of the 5J connector with special wires including high flex, media compatible wire, special use wire, high temperature wire on request.



ISO shown above

**Dimensional Data**

**Technical Data**

ALL DIMENSIONS ARE IN MILLIMETERS UNLESS OTHERWISE NOTED

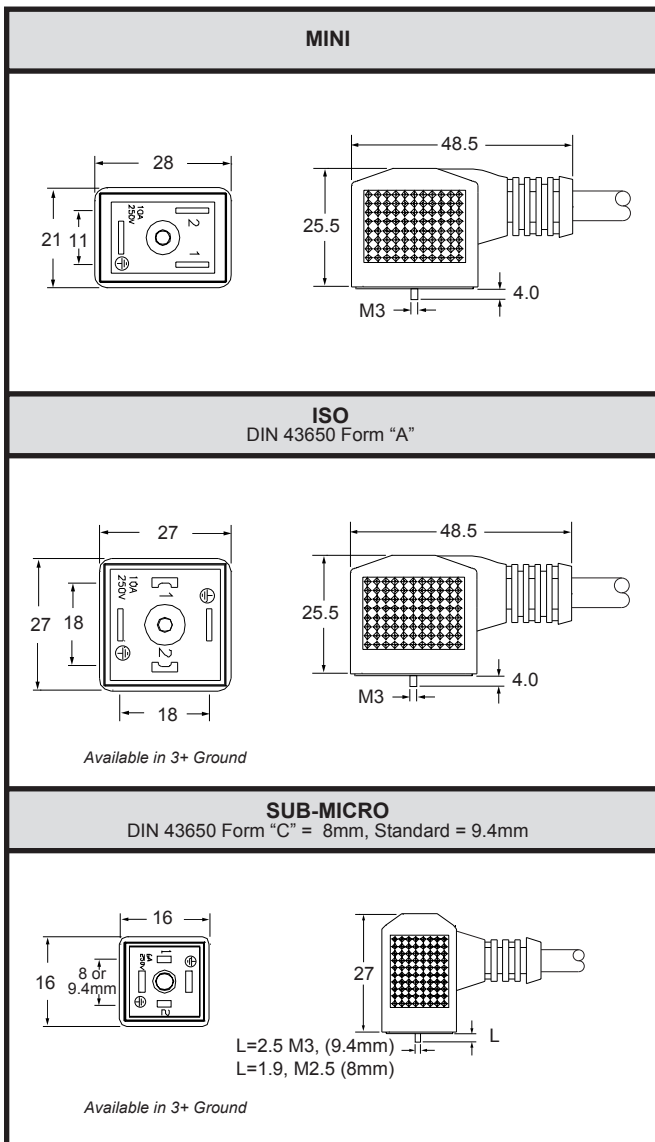

- Cable outlet: Molded construction with wire exiting out perpendicular to the face of the coil
- Available in no circuit, lighted and load suppressed version for all connectors
- Cable conductor colors:  
 European color code: Brown, blue, and yellow/green,  
 (with 4<sup>th</sup> conductor version black)  
 US color code: White, black, and green,  
 (with 4<sup>th</sup> conductor version red)  
 Specials on request
- Cable types: Pressure extruded PVC jacket  
 Hard Usage cordage  
 "S" type with SJTOW standard PVC jacket  
 (ISO and Mini only)
- Cross section of conductor wire: 18 Gauge standard (ISO and Mini)  
 20 Gauge standard (Sub-Micro)
- Rated voltage max.: 250V AC 50/60 Hz, 300V DC
- Rated current max.: 10 Amps (ISO and Mini), 6 Amps (Sub-Micro)
- Enclosure and molded in gasket materials: Polyurethane
- Ambient rated temperatures: -25° to 80°C
- Environment protection: IP 67 and NEMA 6, dust tight and water resistant
- Available in four sizes:  
 DIN 43650 Form "A" (ISO), EN175301-803:2000  
 DIN Form "C" (Sub-Micro 8mm), EN175301-803:2000  
 Industry standard (Sub-Micro 9.4mm pin spacing)  
 Industry standard (Mini 11mm pin spacing)
- Pin configurations: For single solenoid valves - 2 connections plus ground – Mini, ISO, Sub-Micro 8mm and Sub-Micro 9.4mm

For pressure switches, double solenoid valves and other devices, 3 connections plus ground – ISO, Sub-Micro 8mm and 9.4mm

Note: Slight discoloration may occur to translucent material after prolonged exposure to UV rays.



Consult factory for available versions listed by Canadian Standards Association for use with certified electrical equipment.



Consult factory for available versions recognized under the Component Program of Underwriters Laboratories, Inc.

## Ordering Information

5 J    -    -

**Connector Type**  
 3 - 8mm SM\*  
 4 - 9.4mm SM\*  
 5 - MINI\*\*  
 6 - ISO

**Wire Length**  
 6 - 6 ft cord  
 F - 15 ft cord  
 For additional wire lengths, consult factory.

**Contacts**  
 0 - 2+ground down (MINI only)  
 1 - 2+ground up (MINI only)  
 2 - 3+ground down  
 3 - 3+ground up  
 4 - 2+dual ground (ISO/8mm/9.4mm only)  
 Ground left / right available, consult factory.

**Operating Voltage**  
 0 - No light, no suppression\*\*\*  
 2 - 6-24V AC/DC 50/60 Hz  
 5 - 48-120V AC/DC 50/60Hz  
 8 - 208-240V AC 50/60Hz  
 A - 6-24VDC

**Suppression Type**  
 0 - None  
 1 - Diode (DC only)  
 5 - Metal Oxide Varistor (MOV)\*\*

**Lighting Option**  
 0 - Unlighted  
 1 - Lighted\*\*

**Wire Option**  
 US - U.S.A. wire code / PVC jacket  
 EU - European wire code / PVC jacket  
 HU - Hard Usage / SJTOW jacket (MINI & ISO only)  
 High flex, shielded and high temperature wire available on request.

**Housing Color**  
 0 - Black (standard)  
     Translucent (if lighted)  
 1 - Gray

**Packaging Code**  
 A - Bulk  
 G - Individual bagged  
 L - Bulk MAC screw  
 N - Individual bagged MAC screw

MAC is the registered trademark of MAC Valves, Inc.

All connectors come standard with integrated gasket.

\* 240 VAC voltage suppression and lighting not available.

\*\* NOT available in 3+ ground.

\*\*\* Rated 250V AC 50/60Hz, 300V DC.

## Wiring Information

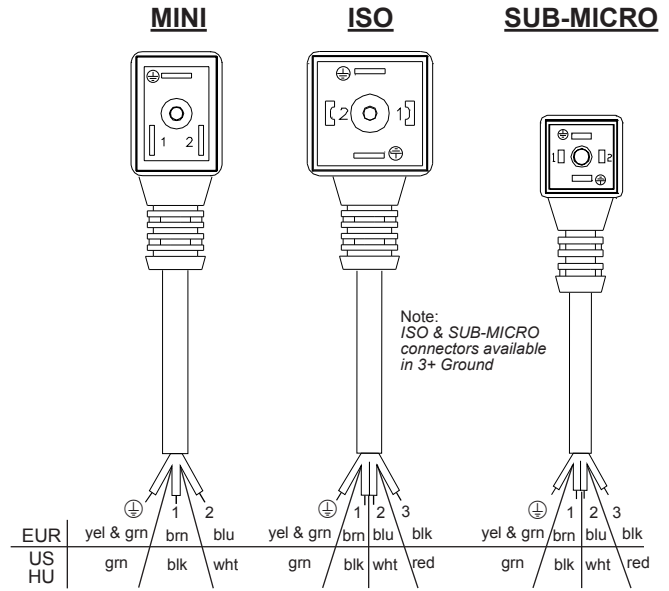

Normal polarity: 1 = (+) Positive, Hot  
 2 = (-) Negative, Neutral  
 ⊕ = Chassis Ground

**Ground Up:**

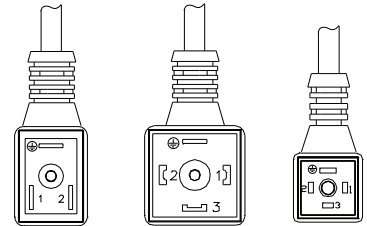

**Ground Down:**

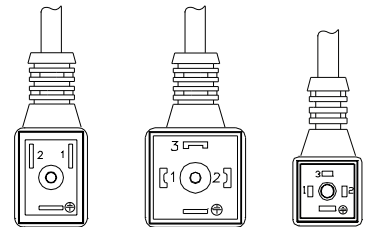

For convenience and faster shipping, this series is available in Can-Paks.



**Accessories:**

WM-315 ISO/MINI Standard Wire Markers 10X Bag

WM-218 Sub-Micro Standard Wire Markers 10X Bag

**Ordering Example:**

5J360-251-US0A

8mm SM, 6 ft wire length, 2+ ground, 6-24V AC/DC 50/60 Hz, MOV, lighted, U.S.A. wire code / PVC jacket, standard housing color, bulk w/ Canfield p/n

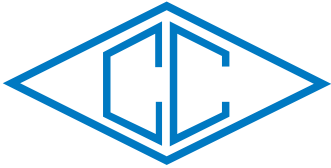

**canfield connector**  
 8510 Foxwood Court  
 Youngstown, Ohio 44514  
 (330) 758-8299 Fax: (330) 758-8912  
 www.canfieldconnector.com

P T 5

**SERIES 5FR**

**RECTIFIED MOLDED SOLENOID VALVE CONNECTORS**

**General Description**

The Canfield Series 5FR solenoid valve connectors incorporate a full-wave bridge rectifier inside a fully molded connector. The 5FR converts alternating current to direct current reducing coil burnout due to valve sticking. Also, direct current eliminates AC "hum" inherent to alternating current. Made from rugged yet flexible polyurethane, the connector housing boasts high durability factors and application versatility. The low profile "straight-line" interface/cord configuration allows for installation in many limited space applications. The integrated gasket design boasts an IP67/NEMA 6 rating and makes it impossible to lose the gasket! Features bi-directional indicator lights, and load suppression (not intended for UL 1449). The Series 5FR is **Proudly Made in the U.S.A.**

**Dimensional Data**

ALL DIMENSIONS ARE IN MILLIMETERS UNLESS OTHERWISE NOTED



ISO shown above

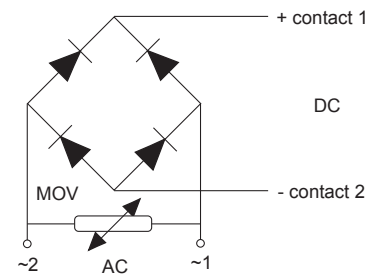
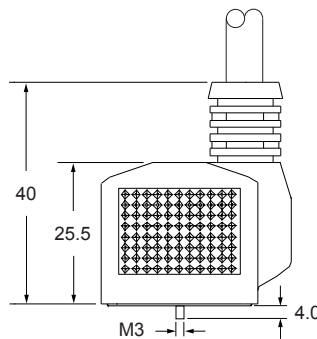
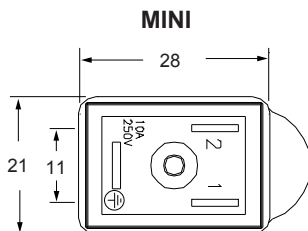
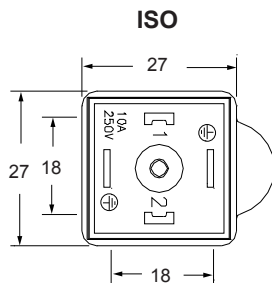

**Technical Data**

- Cable outlet: Molded construction with wire exiting out parallel to the face of the coil
- Color: Black standard or white translucent (for lighted versions)
- Cable conductor colors:
  - European color code: Brown, blue, and yellow/green
  - US color code: White, black, and green
  - Specials on request
- Cable types: Pressure extruded PVC jacket  
HU - SJTOW jacket
- Cross section of conductor wire: 18 Gauge standard
- Rated voltage max.: 250V AC 50/60 Hz
- Voltage drop: 2.2 volt max.
- Current max: Continuous - 1 Amp  
Inrush - 15 Amps for 15 ms
- All versions include MOV suppression
- Enclosure and molded in gasket materials: Polyurethane
- Ambient rated temperatures: -25° to 80°C
- Environment protection: IP 67 and NEMA 6, dust tight and water resistant
- Available:
  - DIN 43650 Form "A" (ISO), EN175301-803:2000
  - Industry standard (MINI 11mm pin spacing)
- Pin configurations: For single solenoid valves - 2 connections plus ground



## Wiring Information

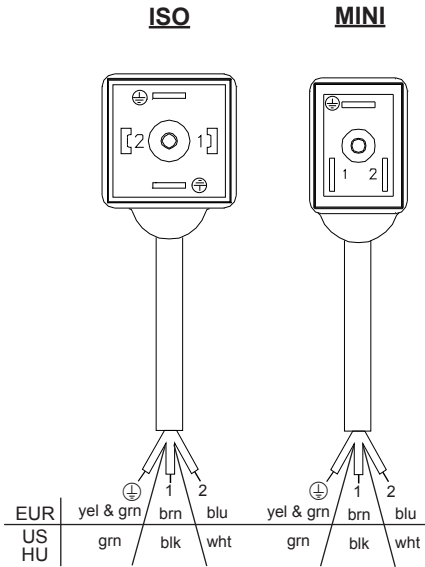

Normal polarity: 1 = (+) Positive, Hot  
 2 = (-) Negative, Neutral  
 3 = NC  
 ⊕ = Chassis Ground

Note: ISO is dual ground

Note: Slight discoloration may occur to translucent material after prolonged exposure to UV rays.



Consult factory for available versions recognized under the Component Program of Underwriters Laboratories, Inc.



Consult factory for available versions listed by Canadian Standards Association for use with certified electrical equipment.

## Ordering Information

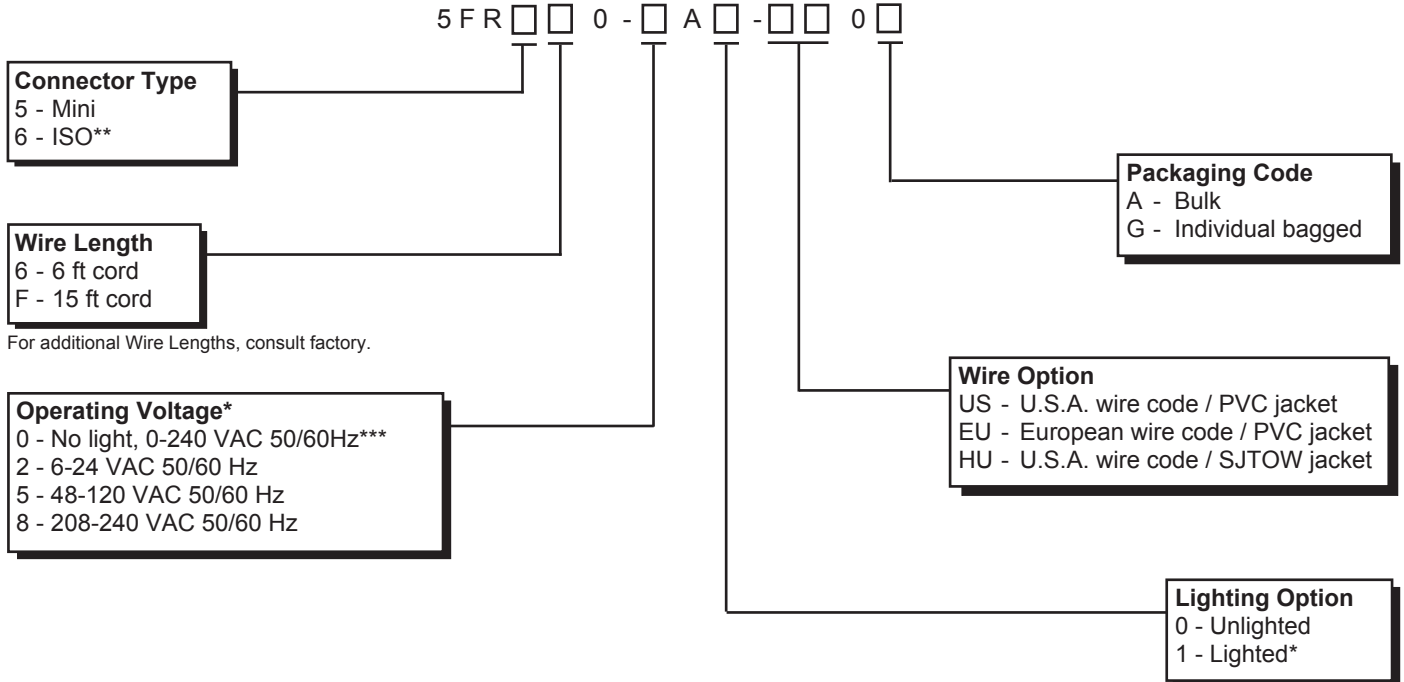

All connectors come standard with integrated gasket.

\* Includes rated MOV suppression

\*\* 2+ dual ground

\*\*\* Rated 250V AC 50/60 Hz. Includes 250V MOV suppression

### Ordering Example:

5FR660-2A1-US0A

ISO, 6 ft wire length, 6-24 VAC 50/60 Hz, lighted, U.S.A. wire code / PVC jacket, bulk packaged

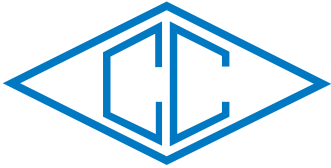

**canfield connector**  
 8510 Foxwood Court  
 Youngstown, Ohio 44514  
 (330) 758-8299 Fax: (330) 758-8912  
 www.canfieldconnector.com

R L 5

## SERIES 5JR

## RECTIFIED MOLDED SOLENOID VALVE CONNECTORS

### General Description

The Canfield Series 5JR solenoid valve connectors incorporate a full-wave bridge rectifier inside a fully molded connector. The 5JR converts alternating current to direct current reducing coil burnout due to valve sticking. Also, direct current eliminates AC "hum" inherent to alternating current. Made from rugged yet flexible polyurethane, the connector housing boasts high durability factors and application versatility. The low profile 90° interface/cord configuration allows for installation in many limited space applications. The integrated gasket design boasts an IP67/NEMA 6 rating and makes it impossible to lose the gasket! Features bi-directional indicator lights, and load suppression (not intended for UL 1449). The Series 5JR is **Proudly Made in the U.S.A.**

### Dimensional Data

ALL DIMENSIONS ARE IN MILLIMETERS UNLESS OTHERWISE NOTED

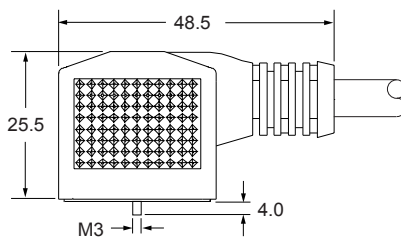
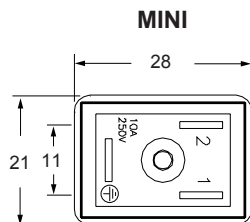
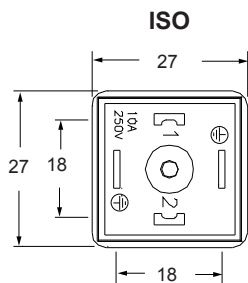

ISO shown above

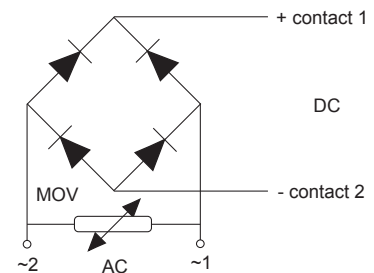

### Technical Data

- Cable outlet: Molded construction with wire exiting out parallel to the face of the coil
- Color: Black standard or white translucent (for lighted versions)
- Cable conductor colors:  
 European color code: Brown, blue, and yellow/green  
 US color code: White, black, and green  
 Specials on request
- Cable types: Pressure extruded PVC jacket  
 HU - SJTOW jacket
- Cross section of conductor wire: 18 Gauge standard
- Rated voltage max.: 250V AC 50/60 Hz
- Voltage drop: 2.2 volt max.
- Current max: Continuous - 1 Amp  
 Inrush - 15 Amps for 15 ms
- All versions include MOV suppression
- Enclosure and molded in gasket materials: Polyurethane
- Ambient rated temperatures: -25° to 80°C
- Environment protection: IP67 and NEMA 6, dust tight and water resistant
- Available:  
 DIN 43650 Form "A" (ISO), EN175301-803:2000  
 Industry standard (MINI 11mm pin spacing)
- Pin configurations: For single solenoid valves - 2 connections plus ground

## Wiring Information

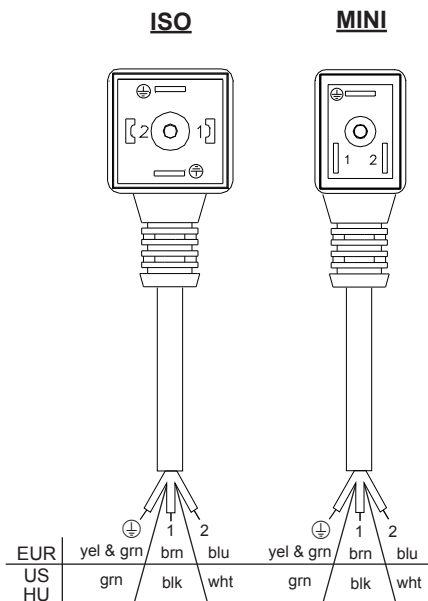

Normal polarity: 1 = (+) Positive, Hot  
 2 = (-) Negative, Neutral  
 3 = NC  
 ⊕ = Chassis Ground

Note: ISO is dual ground

MINI Ground Up



MINI Ground Down



Note: Slight discoloration may occur to translucent material after prolonged exposure to UV rays.



Consult factory for available versions recognized under the Component Program of Underwriters Laboratories, Inc.



Consult factory for available versions listed by Canadian Standards Association for use with certified electrical equipment.

## Ordering Information

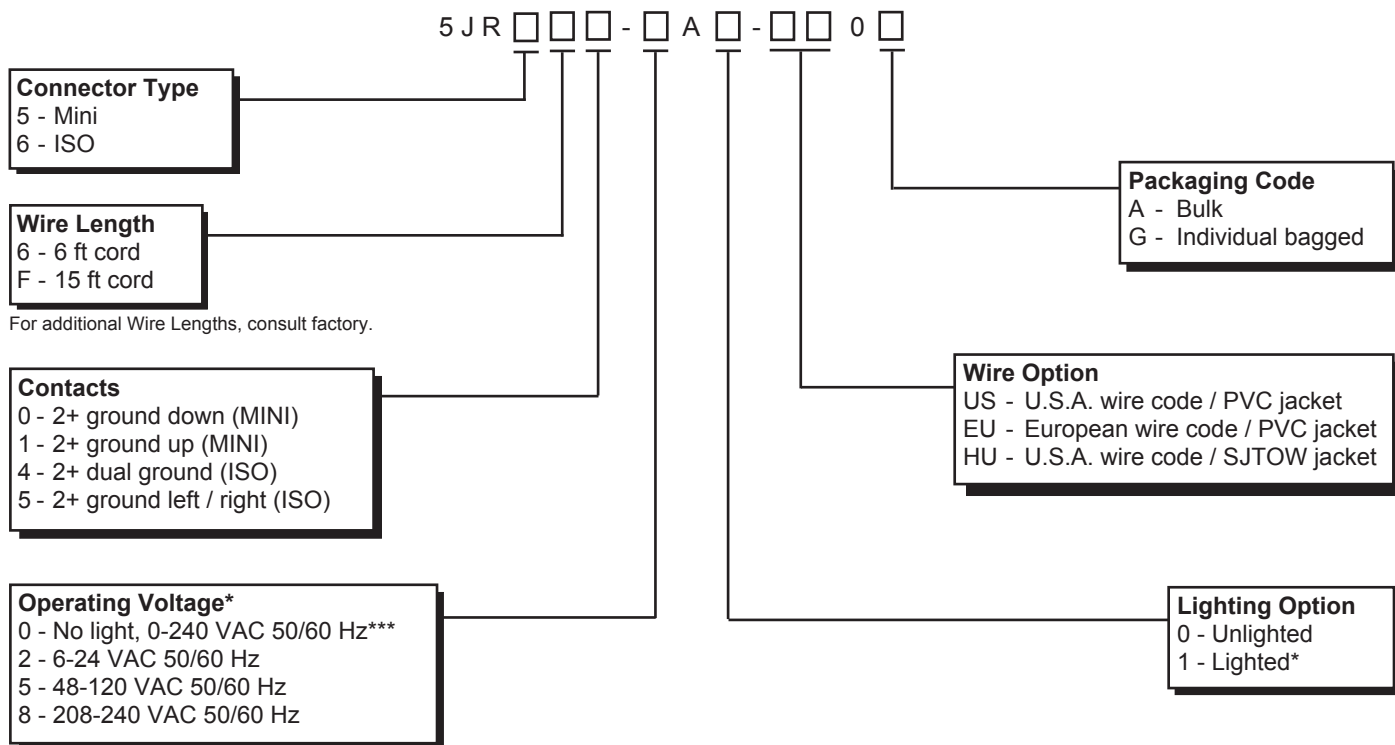

All connectors come standard with integrated gasket.

\* Includes rated MOV suppression  
 \*\*\* Rated 250V AC 50/60 Hz. Includes 250 MOV suppression

### Ordering Example:

5JR664-2A1-US0A

ISO, 6 ft wire length, 2+ dual ground, 6-24 VAC 50/60 Hz, lighted, U.S.A. wire code / PVC jacket, bulk packaged

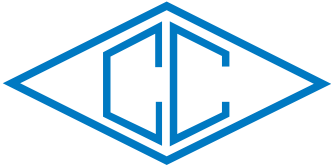

**canfield connector**  
 8510 Foxwood Court  
 Youngstown, Ohio 44514  
 (330) 758-8299 Fax: (330) 758-8912  
 www.canfieldconnector.com

**SERIES 5FFAC**

**FIELDBUS ADAPTER  
 SOLENOID VALVE CONNECTORS**

**General Description**

The Canfield Series 5FFAC all-molded DIN solenoid valve connector/gasket/cord offer a completely molded plug and play design that interfaces female ISO (DIN 43650 Form "A"), MINI and 9.4mm (Industry Standard) and 8mm Sub-Micro (DIN 43650 "C") solenoid connections as shown on the following pages. Made from rugged yet flexible polyurethane, the connector housing boasts high durability factors and application versatility. The low profile "straight line" interface/cord configuration allows for installation in many limited space applications. The integrated gasket design boasts an IP67/NEMA 6 rating, is far better for environmental integrity than field wire versions and makes it impossible to lose the gasket! The 5FFAC and 5JFAC are the only molded valve connectors in the industry that feature bi-directional indicator lights and load suppression (not intended for UL 1449). UL and CSA versions are available as well. The Series 5FFAC is proudly **Made in the U.S.A.**

**Dimensional Data**

ALL DIMENSIONS ARE IN MILLIMETERS UNLESS OTHERWISE NOTED

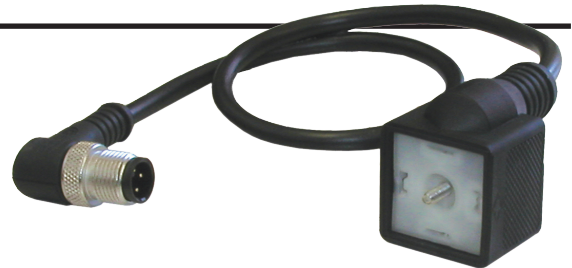

ISO shown above

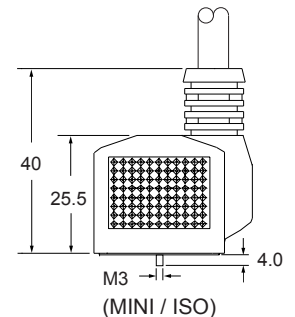
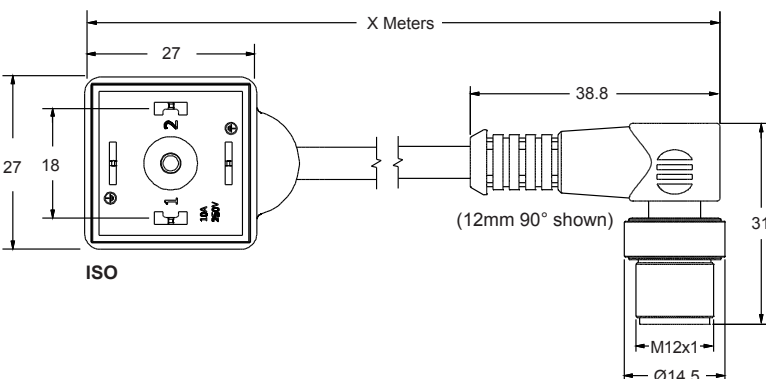
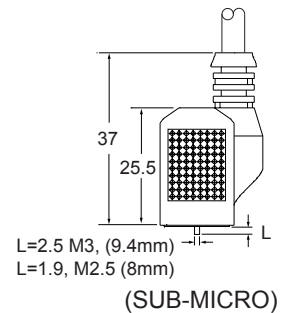
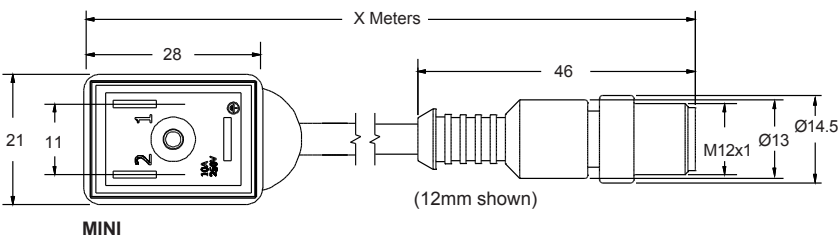
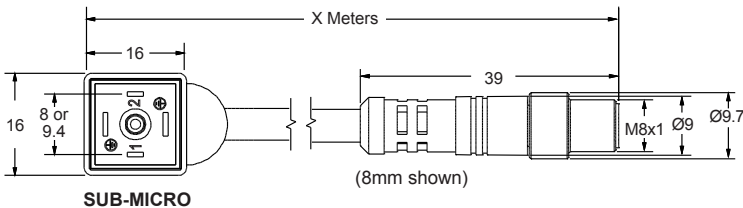

5  
F  
F  
A  
C

## Technical Data

- Cable outlet: Molded construction with wire exiting out parallel to the face of the coil
- Color: Black (standard) or white translucent (for lighted versions)
- Cable types: Black PVC or PUR with & without shield
- Rated voltage max.: 120V AC/DC 50/60 Hz
- Voltage drop: 2.2 volt max.
- Current max: Continuous - 4 Amp  
Inrush - 15 Amps for 15 ms

- Enclosure and molded in gasket materials: Polyurethane
- Ambient rated temperatures: -25° to 80°C
- Environment protection: IP 67 and NEMA 6
- Available in four sizes:  
DIN 43650 Form "A" (ISO), EN175301-803:2000  
DIN Form "C" (Sub-Micro 8mm), EN175301-803:2000  
Industry standard (Sub-Micro 9.4mm pin spacing)  
Industry standard (Mini 11mm pin spacing)
- Pin configurations:  
For single solenoid valves, 2 connections plus ground,  
Mini, ISO, Sub-Micro 8mm and Sub-Micro 9.4mm

## Ordering Guide

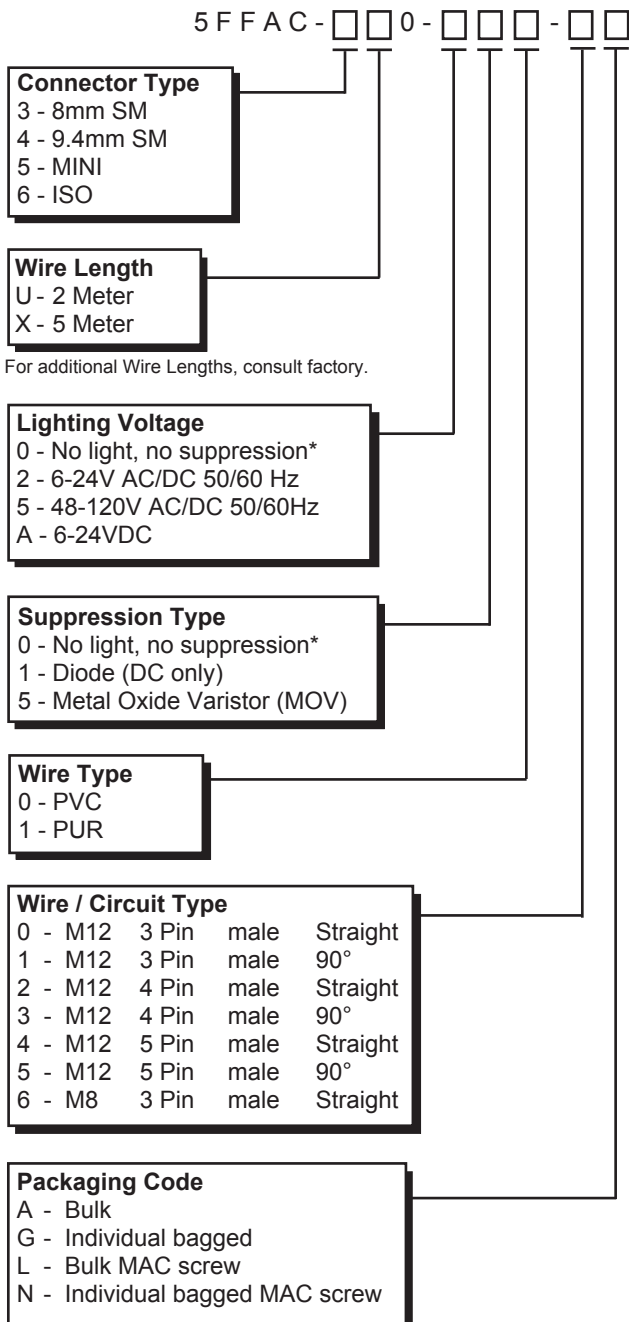

## Circuit Types

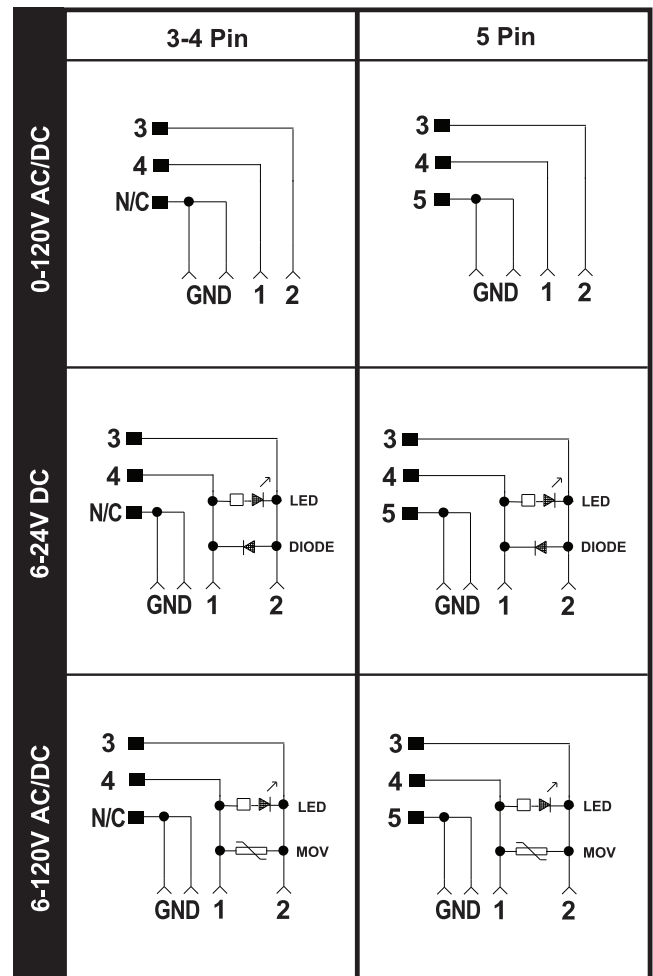

### Ordering Example:

5FFAC-3U0-250-2A

8mm SM, 2 meter wire length, 6-24V AC/DC 50/60 Hz, lighted, MOV, PVC wire type, M12, 4 pin, male, straight, bulk

\* Rated 120V AC/DC 50/60Hz

MAC is the registered trademark of MAC Valves, Inc.

All connectors come standard with integrated gasket.

Note: Slight discoloration may occur to translucent material after prolonged exposure to UV rays.

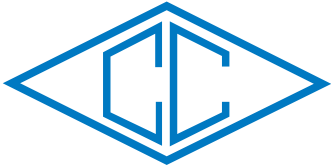

**canfield connector**  
 8510 Foxwood Court  
 Youngstown, Ohio 44514  
 (330) 758-8299 Fax: (330) 758-8912  
 www.canfieldconnector.com

**SERIES 5JFAC**

**FIELDBUS ADAPTER  
 SOLENOID VALVE CONNECTORS**

**General Description**

The Canfield Series 5JFAC all-molded DIN solenoid valve connector/gasket/cord offer a completely molded plug and play design that interfaces female ISO (DIN 43650 Form "A"), MINI and 9.4mm (Industry Standard) and 8mm Sub-Micro (DIN 43650 "C") solenoid connections to 8mm or 12mm (round) circular connectors as shown on the following pages. Made from rugged yet flexible polyurethane, the connector housing boasts high durability factors and application versatility. The low profile "straight line" interface/cord configuration allows for installation in many limited space applications. The integrated gasket design boasts an IP67/NEMA 6 rating, is far better for environmental integrity than field wire versions and makes it impossible to lose the gasket! The 5FFAC and 5JFAC are the only molded valve connectors in the industry that feature bi-directional indicator lights and load suppression (not intended for UL 1449). UL and CSA versions are available as well. The Series 5JFAC is proudly **Made in the U.S.A.**

**Dimensional Data**

ALL DIMENSIONS ARE IN MILLIMETERS UNLESS OTHERWISE NOTED



ISO shown above

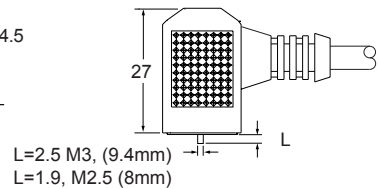
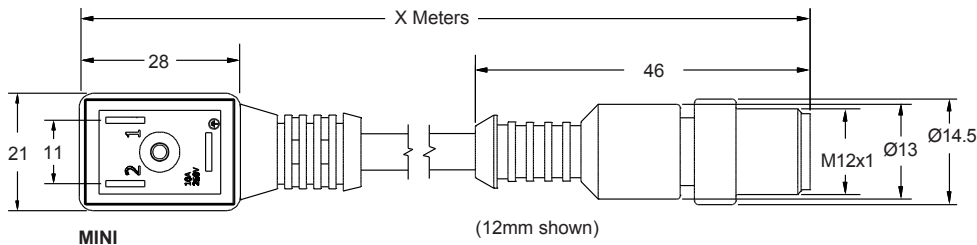
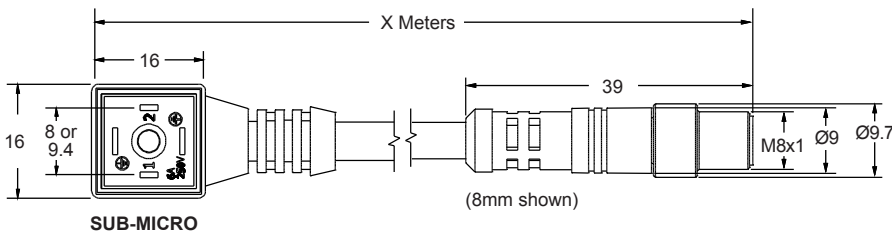

(SUB-MICRO)

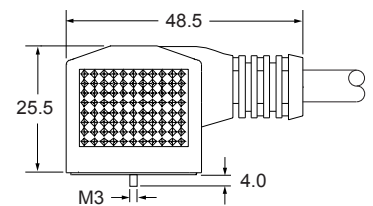
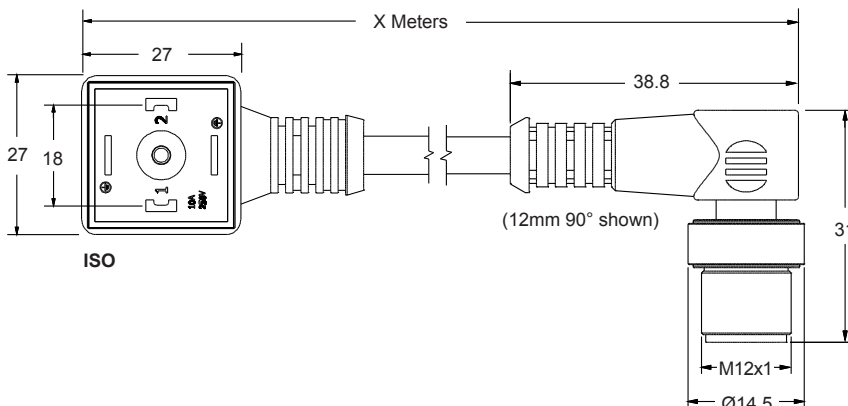

(MINI / ISO)

## Technical Data

- Cable outlet: Molded construction with wire exiting out parallel to the face of the coil
- Color: Black (standard) or white translucent (for lighted versions)
- Cable types: Black PVC or PUR with & without shield
- Rated voltage max.: 120V AC 50/60 Hz
- Voltage drop: 2.2 volt max.
- Current max: Continuous - 4 Amp  
Inrush - 15 Amps for 15 ms
- Enclosure and molded in gasket materials: Polyurethane

- Ambient rated temperatures: -25° to 80°C
- Environment protection: IP 67 and NEMA 6
- Available in four sizes:  
DIN 43650 Form "A" (ISO), EN175301-803:2000  
DIN Form "C" (Sub-Micro 8mm), EN175301-803:2000  
Industry standard (Sub-Micro 9.4mm pin spacing)  
Industry standard (Mini 11mm pin spacing)
- Pin configurations:  
For single solenoid valves, 2 connections plus ground,  
Mini, ISO, Sub-Micro 8mm and Sub-Micro 9.4mm

## Ordering Guide

5 J F A C - □ □ □ - □ □ □ - □ □

### Connector Type

3 - 8mm SM  
4 - 9.4mm SM  
5 - MINI  
6 - ISO

### Wire Length

U - 2 Meter  
X - 5 Meter

For additional Wire Lengths, consult factory.

### Contacts

0 - 2+ ground down (MINI only)  
1 - 2+ ground up (MINI only)  
4 - 2+ dual ground up/down

Ground left / right available, consult factory.

### Lighting Voltage

0 - No light, no suppression\*  
2 - 6-24V AC/DC 50/60 Hz  
5 - 48-120V AC/DC 50/60Hz  
A - 6-24VDC

### Suppression Type

0 - No light, no suppression\*  
1 - Diode (DC only)  
5 - Metal Oxide Varistor (MOV)

### Wire Type

0 - PVC  
1 - PUR

### Wire / Circuit Type

0 - M12	3 Pin	male	Straight
1 - M12	3 Pin	male	90°
2 - M12	4 Pin	male	Straight
3 - M12	4 Pin	male	90°
4 - M12	5 Pin	male	Straight
5 - M12	5 Pin	male	90°
6 - M8	3 Pin	male	Straight

### Packaging Code

A - Bulk  
G - Individual bagged  
L - Bulk MAC screw  
N - Individual bagged MAC screw

## Circuit Types

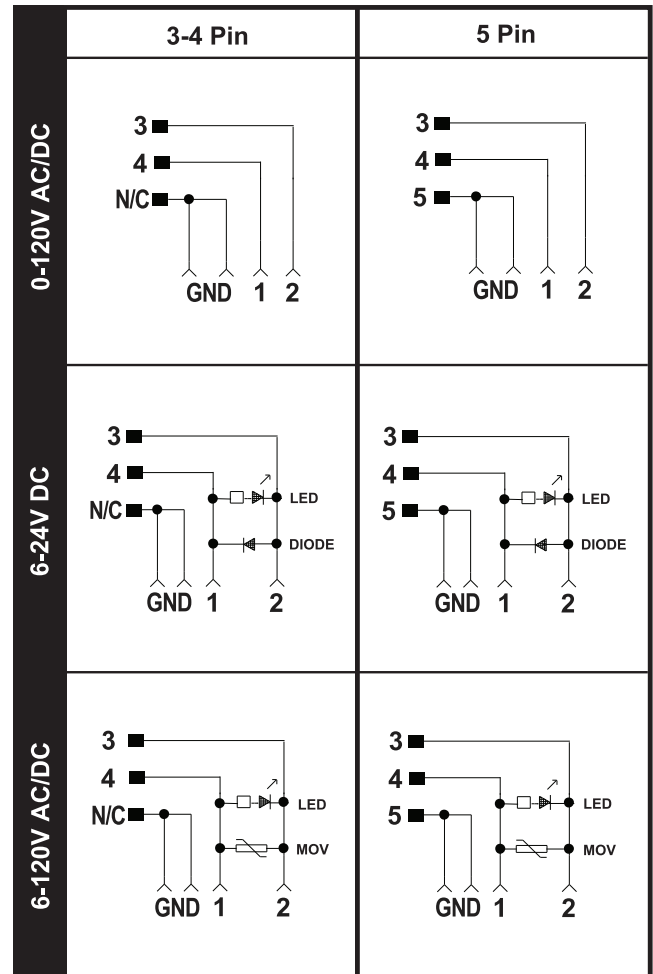

### Ordering Example:

5JFAC-3U4-250-2A

8mm SM, 2 meter wire length, 2+ ground down up/down, 6-24V AC/DC 50/60 Hz, lighted, MOV, PVC wire type, M12, 4 pin, male, straight, bulk

\* Rated 120V AC/DC 50/60Hz

MAC is the registered trademark of MAC Valves, Inc.

All connectors come standard with integrated gasket.

Note: Slight discoloration may occur to translucent material after prolonged exposure to UV rays.

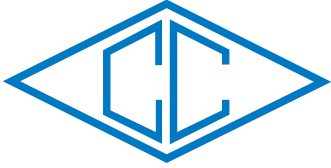

**canfield connector**  
 8510 Foxwood Court  
 Youngstown, Ohio 44514  
 (330) 758-8299 Fax: (330) 758-8912  
 www.canfieldconnector.com

**SERIES R5000**

**ISO RECTIFIED  
 SOLENOID VALVE CONNECTORS**

**General Description**

Canfield Connector's R5000 Series solenoid valve connectors incorporate full-wave bridge rectifiers inside the DIN 43650 Form "A" / ISO 4400, EN175301-803:2000 connectors. This standard permits industry interchange-ability and has been embraced by the solenoid valve industry worldwide. The R5000 converts alternating current to direct current reducing coil burnout due to valve sticking. Also, direct current eliminates AC "hum" inherent to alternating current. Features include the ability for the user to wire the connector into existing installations. Wire connections are made inside the connector housing and the wire inlet is either PG9 strain relief, 3/8" or 1/2" conduit. The R5000 has a maximum current rating of 1 Amp continuous with maximum wire gauge diameter of 14 AWG. An indicator light is offered for instant diagnostics and to aid setup and installation.



**Dimensional Data**

ALL DIMENSIONS ARE IN MILLIMETERS UNLESS OTHERWISE NOTED

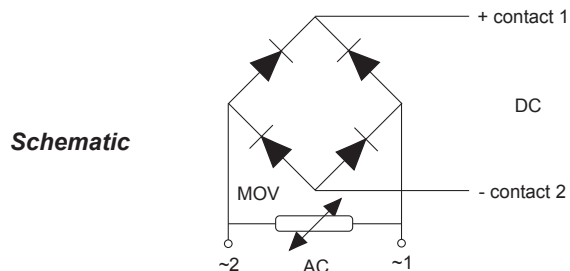
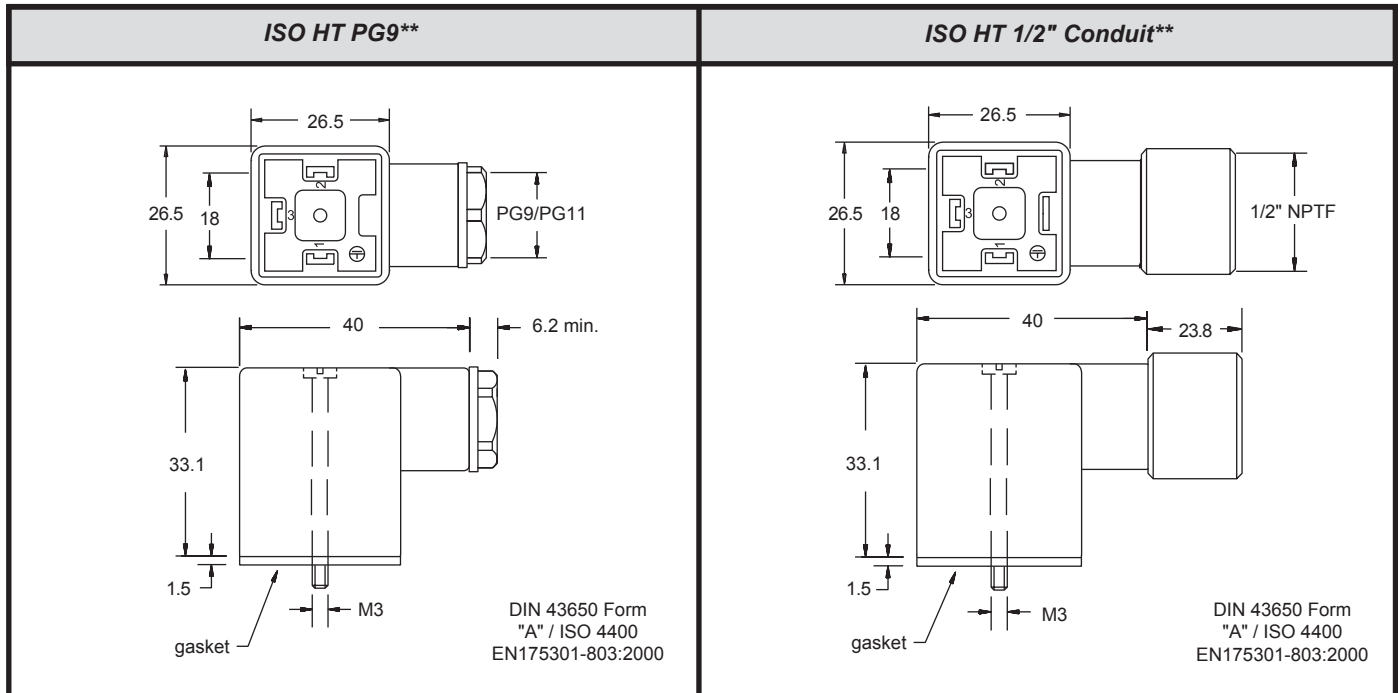

Consult factory for available versions listed by Canadian Standards Association for use with certified electrical equipment.



**Technical Data**

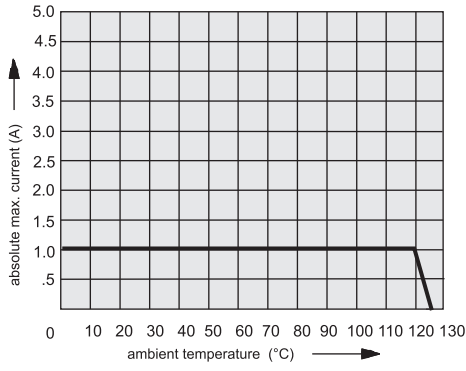

**Derating Curve**

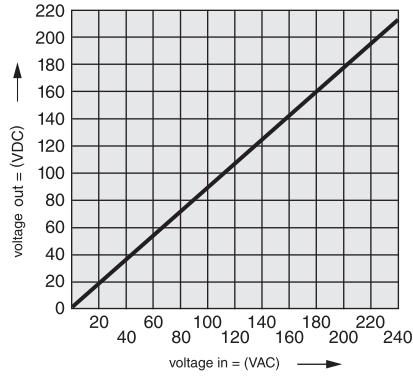

- Voltage max.: 250 VAC 50/60 Hz
- Voltage drop: 2.2 volt max.
- Current max.: Continuous - 1 Amps  
Inrush - 15 Amps for 15 ms
- Wire gauge max.: 14 AWG

- Recommended cable diameter:  
PG9 - .236 to .315 inches O.D.  
PG11 - .315 to .394 inches O.D.  
3/8" Conduit - .410 inch max.  
1/2" Conduit - .410 inch max.
- Gaskets temperature max.: Nitrile -25° to +90°C  
Silicone -40° to +125°C
- Environmental protection: NEMA 4 and IP 65 dust tight and water resistant

**Ordering Information**

Use a prefix of "G" for Individually Bagged

R 5  0  -    0 0 0 0

**Orientation**  
1 - Ground down  
Other ground orientations available.  
Please consult factory.

**Lighting Specification**  
0 - Unlighted (black housing)  
3 - 6 - 48 VAC 50/60 Hz  
(translucent housing)  
7 - 100 - 240 VAC 50/60 Hz  
(translucent housing)

**Connector Types**  
08 - ISO HT strain relief PG9\*\*  
09 - ISO HT strain relief PG11\*\*  
10 - ISO HT 1/2" conduit\*\*  
18 - ISO HT strain relief PG9 gray\*\*  
19 - ISO HT strain relief PG11 gray\*\*  
20 - ISO HT 1/2" conduit gray\*\*

**Gasket**  
1 - Nitrile  
2 - Silicone  
3 - Nitrile profile

\* With ISO only  
\*\* HT refers to High Top - Larger connector for larger wire gauge and easy installation.

Not all combinations are available. Consult factory for details.

Each connector kit contains fastening hardware and gasket assembly.

**Ordering Example:**

R5100-1080000

Rectified, ground down, unlighted, nitrile gasket, ISO HT strain relief PG9 connector

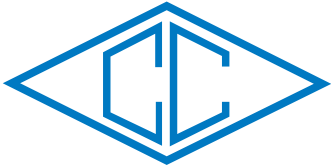

**canfield connector**  
 8510 Foxwood Court  
 Youngstown, Ohio 44514  
 (330) 758-8299 Fax: (330) 758-8912  
 www.canfieldconnector.com

**SERIES D5400 (MSD)  
 MICRO SOLENOID DRIVER, POWER CONVERTER**



**General Description**

The Canfield Connector Series D5400 Micro Solenoid Driver is a NEMA 4 DIN 43650 Form "A" / ISO 4400, EN175301-803:2000 and MINI type connector with a built in electronic circuit used to induce solenoid pull-in and reduce holding current. The time proven MSD has been designed into many applications where heat buildup occurs which reduces operating efficiency and life span of solenoid valves. The MSD has two main functions: one is to induce faster or stronger than usual response times at solenoid pull-in, the second is to reduce the net wattage of the solenoid during hold-in. The MSD drives the coil with a high input voltage for a fixed time period until the coil has shifted at which time the MSD reduces the holding voltage, which saves power, and the solenoid runs cool. The MSD is often used to replace low voltage power supplies where a 24 VDC solenoid valve can then be operated by 120 VAC. The Alternating current is rectified and the duty cycle reduced so as to operate the valve at proper voltage and wattage ranges. An additional advantage can be found when the MSD drops the holding voltage, which then reduces heat and current requirements.

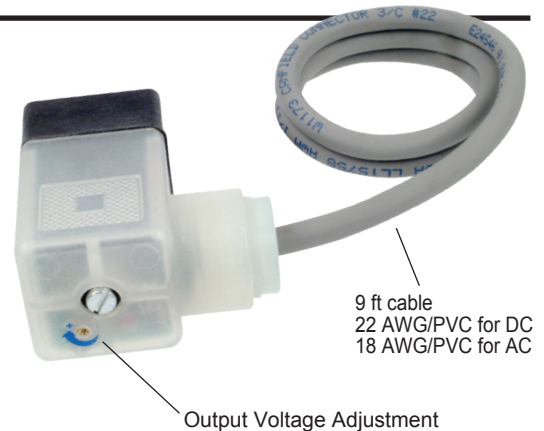

**Dimensional Data**

ALL DIMENSIONS ARE IN MILLIMETERS UNLESS OTHERWISE NOTED

*Reduce Heat • Increase Speed*

ISO Connector	MINI & ISO Profile View	MINI Connector

**Features**

- Speed operator cycle rates with greater consistency
- Enable coils to be energized for extended periods without burnout
- Save energy by reducing overall coil consumption
- Reduce hold-in voltage to reduce coil heat related losses
- Enclosure NEMA 4 accepted
- MINI or DIN 43650 Form "A" / ISO 4400, EN175301-803:2000 electrical connector enclosure saves hook up space and is a generally accepted quick connect interface
- Increases coil life expectancy
- All versions have LED indicator lights
- 9 ft cable is standard on all versions

D  
5  
4  
0  
0

### Technical Data

- Ambient temperature range: -20° to +50° C
- Maximum input voltage tolerance: 10%
- Input voltage: AC or DC (in different versions)
- Output voltage: DC
- Peak output voltage: Supply -0.5v
- Maximum output current: 8 Amps inrush for 50 ms / 1 Amp holding
- Maximum allowable input DC ripple: 20% peak to peak
- 2 ms max. response time

### How it Works

The MSD allows the input line voltage directly to the coil for a fixed single shot of 50 milliseconds. After that period, the MSD automatically pulses the input voltage to the coil. In either fixed or adjustable versions, the MSD turns the power on and off so fast that the armature does not respond. By adjusting the off period so that it is longer than the on period, the net RMS voltage decreases and wattage is decreased. Many coils can be adjusted much lower than expected due to the fact that much less energy is required for hold-in as opposed to pull-in.

D5400

### Output Waveforms

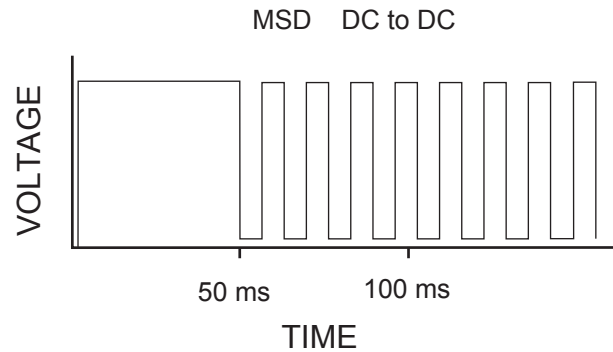
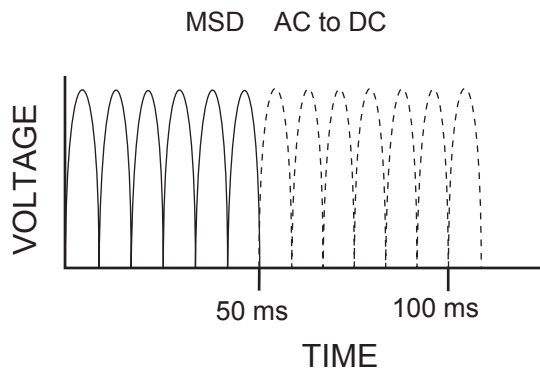

Output Frequency = 1.6 KHz

### Ordering Information

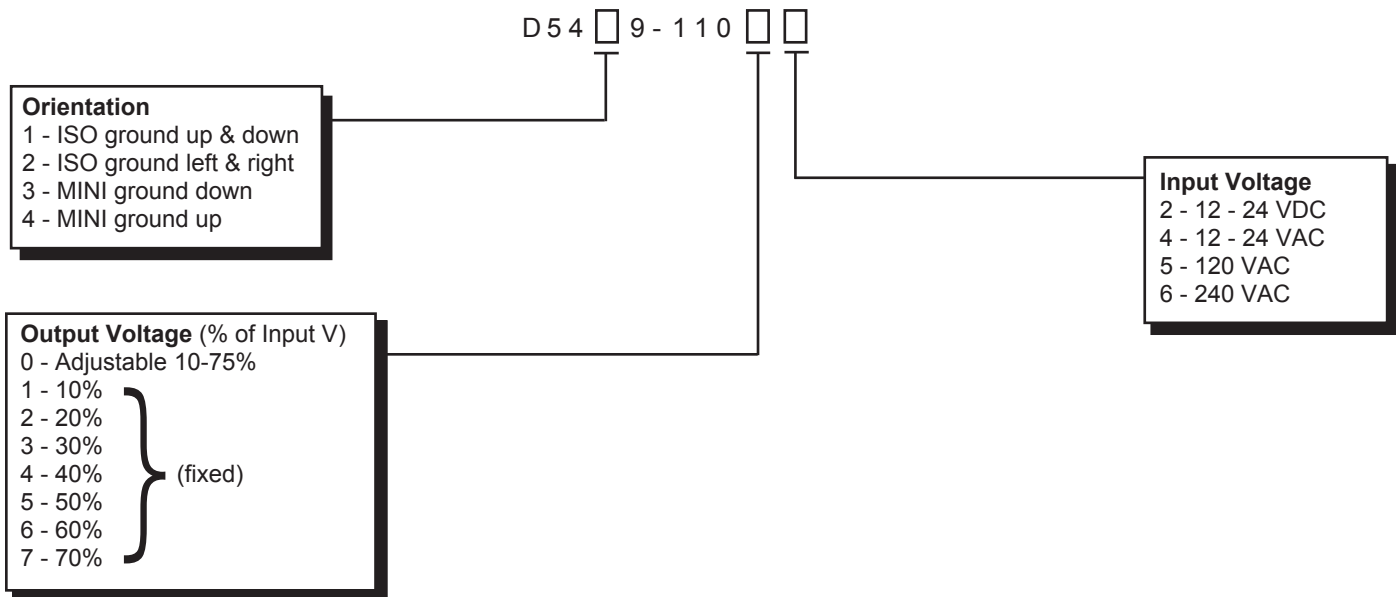

### Ordering Example:

D5439 - 11005

MINI ground down, adjustable output, 120 VAC

Each connector kit contains screw, washer and gasket assembly.

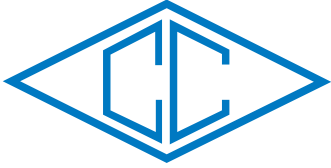

**SERIES P5600 (MPC)  
 MICRO PROTECTIVE CONNECTORS**

**Surge Suppression**

**General Description**

The Micro Protective Connectors are available in standard MINI, DIN 43650 Form "A" / ISO 4400, EN175301-803:2000 and Sub-Micro 8mm and 9.4mm. The Canfield Connector MPCs provide electrical controllers surge suppression against voltage spikes caused by the solenoids used on hydraulic and pneumatic solenoid valves.

**Dimensional Data**

ALL DIMENSIONS ARE IN MILLIMETERS UNLESS OTHERWISE NOTED (COMPLETE DIMENSIONAL INFORMATION IS PROVIDED ON INDIVIDUAL PAGES)

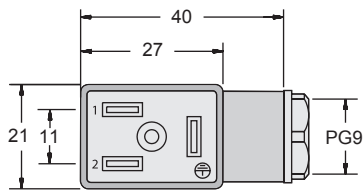
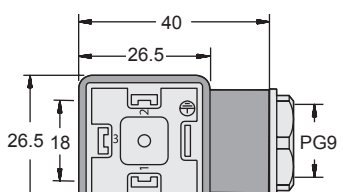
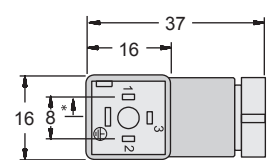
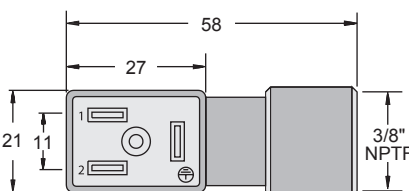
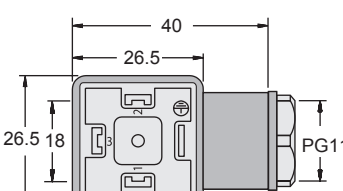
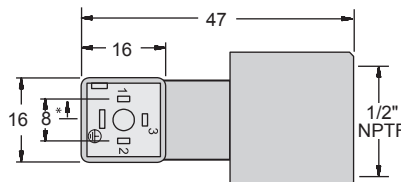
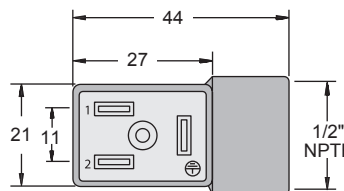
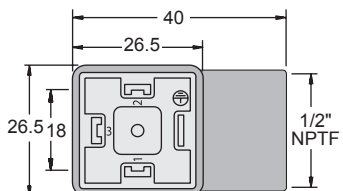
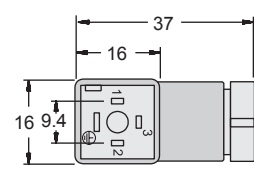
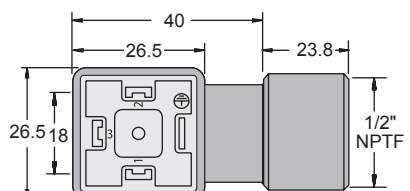
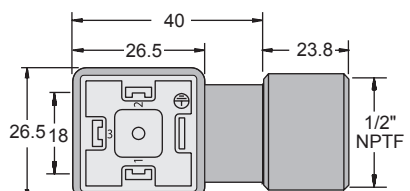
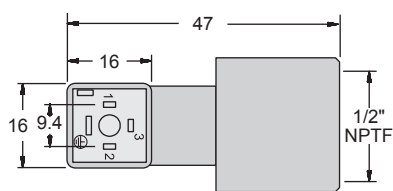
<p><b>MINI</b></p>	<p><b>ISO</b>            DIN 43650 Form "A" / ISO 4400,            EN175301-803:2000</p>	<p><b>Sub-Micro</b>            (8mm) DIN 43650 Form "C" / ISO 4400,            EN175301-803:2000</p>
 <p><b>PG9</b></p>	 <p><b>PG9 / HT PG9</b></p>	 <p><b>8mm Strain Relief</b>  <small>*Ground spade offset by 0.2mm toward pin 1.</small></p>
 <p><b>3/8" Conduit</b></p>	 <p><b>PG11 / HT PG11</b></p>	 <p><b>8mm 1/2" Conduit</b>  <small>*Ground spade offset by 0.2mm toward pin 1.</small></p>
 <p><b>1/2" Conduit</b></p>	 <p><b>1/2" Conduit</b></p>	 <p><b>9.4mm Strain Relief</b></p>
 <p><b>HT 1/2" Conduit</b></p>	 <p><b>HT 1/2" Conduit</b></p>	 <p><b>9.4mm 1/2" Conduit</b></p>

0065P

## Technical Data

- Voltage max.: 240 VAC / 120 VDC
- Current max.: ISO - 10 Amps  
MINI - 10 Amps  
Sub-Micro - 6 Amps
- Wire gauge max.: ISO - 14 AWG  
MINI - 14 AWG  
Sub-Micro - 20 AWG

NOTE: When using MAC Valves with 9.4mm Sub-Micro, consult our factory.

- Recommended cable diameter:  
PG7 - .157 to .236 inches O.D.  
PG9 - .236 to .315 inches O.D.  
PG11 - .315 to .394 inches O.D.  
1/2" Conduit - .410 inch max. for MINI & ISO  
1/2" Conduit - .250 inch max. for Sub-Micro
- Gaskets temperature max.: Nitrile: -25° to +90°C  
Silicone: -40° to +125°C
- Environmental protection: NEMA 4 and IP 65 dust tight and water resistant

## Advantages of Suppression

- Ideal for use with reed switch proximity sensor.
- Reduce contact burnoff, increasing switch life.
- High frequency interference pulses reduced, lowering electronic noise.
- Protect programmable controllers and other types of electronic devices from inductive spikes.
- Addition of extra modules or hardware is not required.
- Most suppression systems are available with standard connectors.

## MPC Types

### Type 1\*

Diode in parallel with coil. When switch ( $S_1$ ) is opened, the energy stored in the coil is trapped and dissipated by the diode ( $D_1$ ).

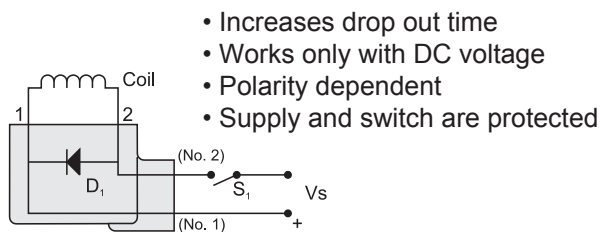

### Type 5\*

MOV (metal oxide varistor) in parallel with coil. When switch ( $S_1$ ) is opened or closed, the energy stored in the coil is limited by the MOV.

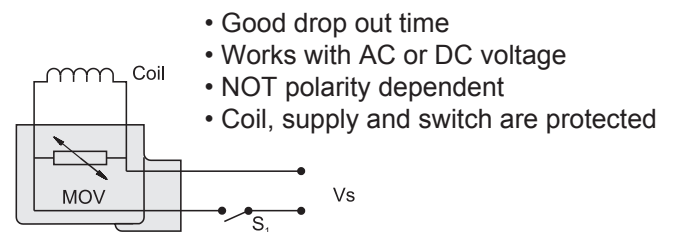

### Type 2

Diode & Zener in parallel with coil. When switch ( $S_1$ ) is opened, the energy stored in the coil is trapped and dissipated by the diode ( $D_1$ ) and zener diode ( $Z_1$ ) and the coil resistance.

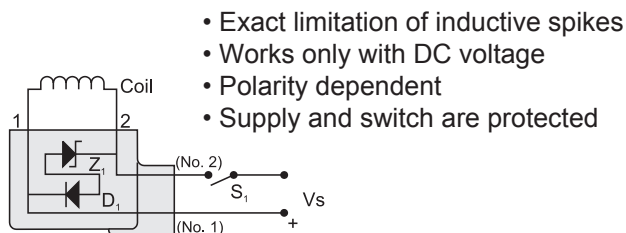

### Type 6

RC Network in parallel with coil. When switch ( $S_1$ ) is opened or closed, the energy stored in the coil is absorbed by the capacitor ( $C_1$ ) and dissipated by the resistor ( $R_1$ ).

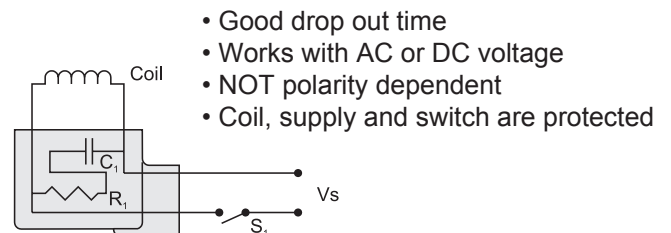

### Type 3

Transorb in parallel with coil. When switch ( $S_1$ ) is opened or closed, the energy stored in the coil is limited by transorb.

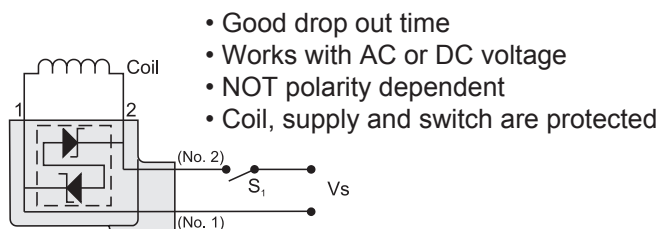

\*Most Commonly Used

## Ordering Information

Use a prefix of "G" for Individually Bagged

P 5  0  -      0 0

### Orientation

1 - Ground down  
Other ground orientations available.  
Please consult factory.

### Operating Voltage

3 - 6 - 48 VDC  
4 - 48 - 120 VDC  
5 - 6 - 48 V AC/DC 50/60 Hz  
6 - 48 - 120 V AC/DC 50/60 Hz  
7 - 120 - 240 V AC/DC 50/60Hz

### Gasket

1 - Nitrile  
2 - Silicone  
3 - Nitrile profile<sup>††</sup>

### Connector Type

3 - MINI strain relief PG9  
4 - MINI 3/8" conduit  
5 - MINI 1/2" conduit  
6 - ISO strain relief PG9  
7 - ISO strain relief PG11  
8 - ISO 1/2" conduit  
B - Sub-Micro strain relief PG7 (9.4mm)\*\*  
C - Sub-Micro 1/2" conduit (9.4mm)\*\*  
D - Sub-Micro strain relief PG7 (8mm)\*\*  
E - Sub-Micro 1/2" conduit (8mm)\*\*

### Housing Color

0 - Black "B" standard. Translucent if lighted.  
1 - Gray "A"

### Lighting Specification

0 - Unlighted  
1 - Lighted

### MPC Circuit

1 - Diode (DC Only)  
2 - Diode & Zener diode (DC Only)  
3 - Transorb (AC/DC)<sup>†</sup>  
5 - MOV (AC/DC)  
6 - RC network (AC/DC)



Quick-Ship  
Bulk Packs

### SERIES P5600

Can-Pak	
Part Number	Qty
CP-P5103-1311000-025	25
CP-P5103-1311000-100	100
CP-P5103-1351000-025	25
CP-P5103-1351000-100	100
CP-P5107-1351000-025	25
CP-P5107-1351000-100	100
CP-P5103-1611000-025	25
CP-P5103-1611000-100	100
CP-P5103-1651000-025	25
CP-P5103-1651000-100	100
CP-P5107-1651000-025	25
CP-P5107-1651000-100	100

<sup>†</sup> NOT available in Operating Voltage 7

<sup>††</sup> NOT available in Sub-Micro

\* NOT available in MINI type connectors

\*\* MPC Circuits 1 & 5 only

*Consult factory for custom configurations.*

Each connector kit contains screw, washer and gasket assembly.

NOTE: When using MAC Valves with 9.4mm Sub-Micro, consult our factory.

### Ordering Example:

P5103-1310000

Ground down, 6 - 48 VDC, nitrile gasket, MINI strain relief PG9, Diode, unlighted, black house

0065P

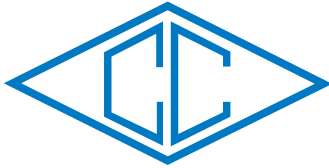

**canfield connector**  
 8510 Foxwood Court  
 Youngstown, Ohio 44514  
 (330) 758-8299 Fax: (330) 758-8912  
 www.canfieldconnector.com

## SERIES FAC

## FIELD BUS ADAPTER SOLENOID VALVE CONNECTORS

### General Description

The FAC series connectors are modular interface connectors made to conform to industry standard configurations. These connectors interface female ISO, MINI and Sub-Micro solenoid connections to industry standard male 7/8" (MINI) and 12mm (Micro) circular connectors. These are as shown on the following pages. These rugged modular connectors offer rapid installation and environmental protection designed to IP 65 and NEMA 4. Options include indication LED, surge suppression and various pre-wired circuit configurations to connect with popular multi-port electronic interconnection systems and field-bus systems.



FAC

### Dimensional Data

ALL DIMENSIONS ARE IN MILLIMETERS UNLESS OTHERWISE NOTED

MINI	ISO	SUB-MICRO 8mm or 9.45mm
	<p>DIN 43650 Form "A" / ISO 4400, EN17530-803:2000</p>	<p>DIN 43650 Form "C", EN17530-803:2000</p>

### † Optional Circuit Types

#### PNP Type 0 - 4 pole

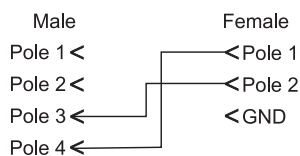

#### PNP Type 0 - 5 pole

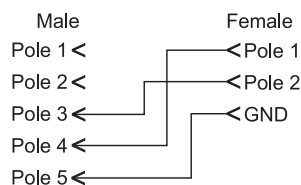

#### NPN Type 1 - 4 pole

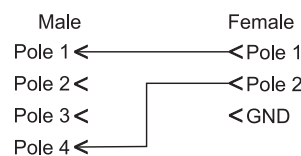

#### NPN Type 1 - 5 pole

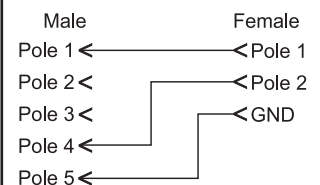

Male connector color code (Pole 1 - Brown, Pole 2 - White, Pole 3 - Blue, Pole 4 - Black, Pole 5 - Gray)

### Automotive Standard Circuit Types

#### 3 pole to ISO or MINI

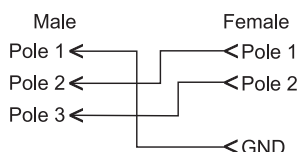

#### 5 pole to ISO or MINI

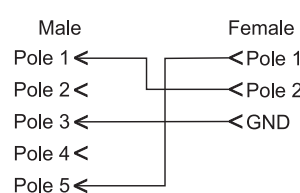

#### 5 pole to 3+G ISO

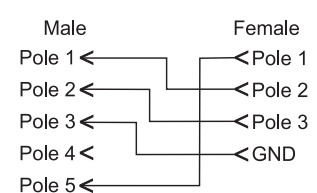

## Technical Data

- Wire: Black PVC
- Nominal Voltage Rating: See Connector Type
- Max. Nominal Current: 3/4 Pole 4 Amps  
5 Pole 3 Amps
- Environmental Protection: IP 65/NEMA 4
- Temperature Rating: -25° to +85°C



Consult factory for available versions listed by Canadian Standards Association for use with certified electrical equipment.

FAC

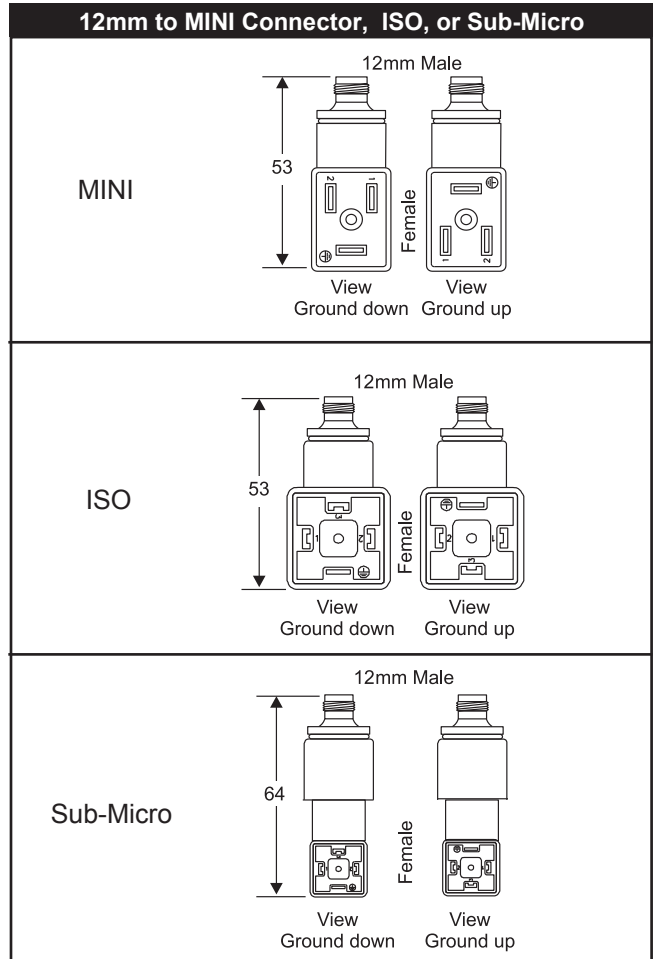
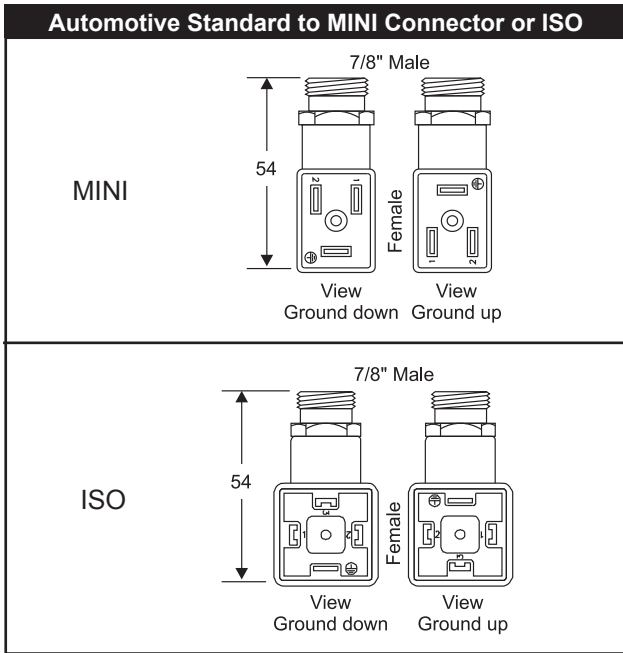

## Ordering Information

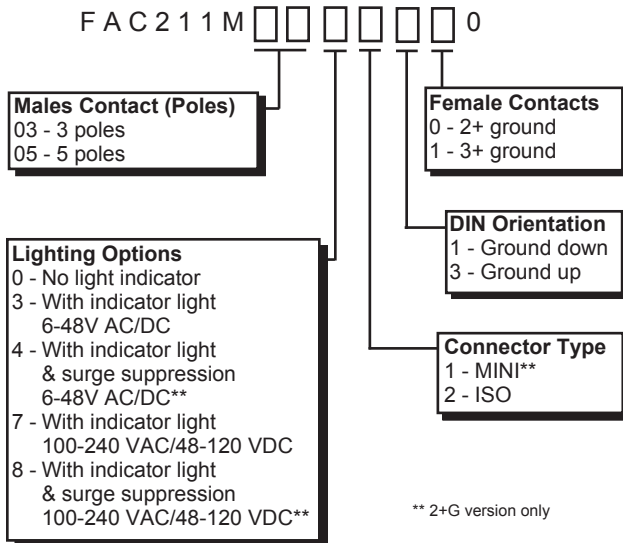

## Ordering Information

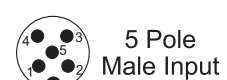
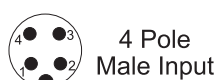
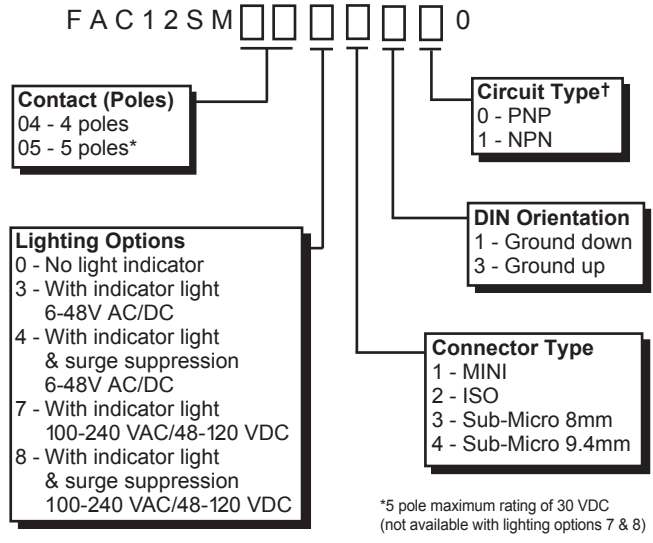



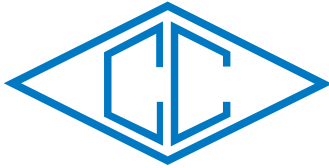

**canfield connector**  
 8510 Foxwood Court  
 Youngstown, Ohio 44514  
 (330) 758-8299 Fax: (330) 758-8912  
 www.canfieldconnector.com

**SERIES iLW**

**INTERPOSED LIGHTED WAFER  
 (MRO) RETRO-FIT INDICATOR LIGHT**

**General Description**

The Canfield Interposed Lighted Wafer is an electronic, state of the art lighting module designed to install between a DIN type coil and the mating connector. Utilizing SMT (Surface Mount Technology), the iLW's ultra-thin design and high luminescence Gallium Arsenide LEDs enable the lighted wafer to retrofit existing applications or to be used in conjunction with unlighted connectors. Designed to "sandwich" between the connector and the coil, the iLW seals from dust and moisture. The iLW can be installed several times without degradation of the contact surfaces and is not polarity dependent.

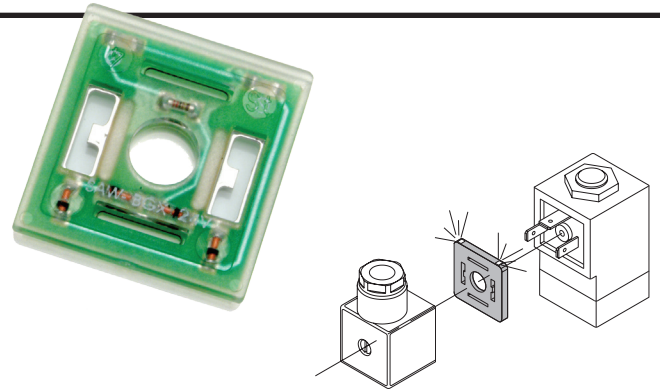

iLW

**Dimensional Data**

ALL DIMENSIONS ARE IN MILLIMETERS UNLESS OTHERWISE NOTED

Sub-Micro	MINI	DIN 43650 Form "A" / ISO 4400

**Technical Data**

- Retrofits: Sub-Micro 8mm  
 Sub-Micro 9.4mm  
 MINI Standard  
 DIN 43650 Form "A" / ISO 4400,  
 EN175301-803:2000
- Environmental protection: NEMA 4 and IP 65 dust tight and water resistant
- Ambient temperature range: -20° to +90°C
- Polyurethane encapsulation

**Electrical Data**

- Voltages available: 12 - 24V AC/DC 10 mA max.  
 120V AC 6 mA max.  
 240V AC 9 mA max.
- Light source: Gallium Arsenide light emitting diode
- Not polarity dependent

**Ordering Information**

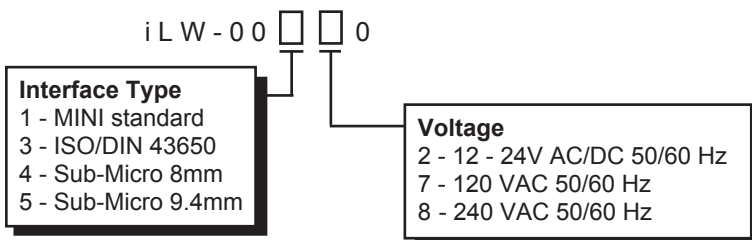

**Ordering Example:**

iLW-00170

MINI standard, 120 VAC 50/60 Hz.

NOTE: When using MAC Valves with 9.4mm Sub-Micro, consult our factory. MAC is the registered trademark of MAC Valves, Inc.

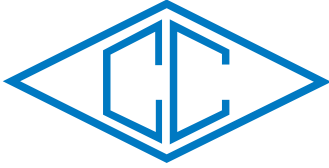

**canfield connector**  
8510 Foxwood Court  
Youngstown, Ohio 44514  
(330) 758-8299 Fax: (330) 758-8912  
www.canfieldconnector.com

## SERIES M5

## MALE CONNECTORS

### General Description

Canfield male connectors are used as electrical quick disconnect interfaces for pneumatic and hydraulic valves and sensors. They are available in standard MINI, DIN 43650 Form "A" / ISO 4400, EN175301-803:2000, Sub-Micro 8mm, 9.4mm, and conduit arrangements. Some male connectors are available with 2+ ground or 3+ ground terminal options.

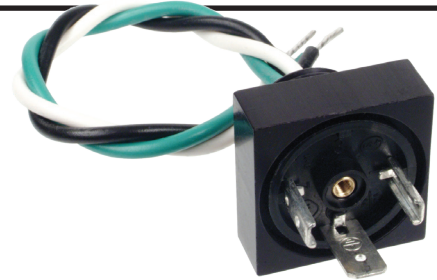

M  
5

### M03010 MINI Male for Molding

This MINI male connector is used as an electrical quick connect. It is generally applied during the molding, potting, or epoxying process for pneumatic and hydraulic valves or pressure switches. The M03010 male connector is built to mate with the Series 5000 or other standard MINI female connectors.

#### Features

- 2+ Ground Terminals
- 250V AC/DC max.
- 10 Amps max. rating
- Glass Fiber Reinforced Nylon
- Temp. rating -40° to +125° C

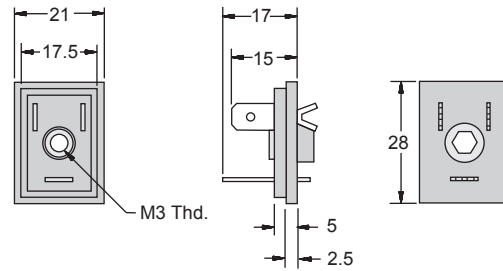

### M03110 MINI Male for Plate Mounting

This MINI male connector is used as an electrical quick connect for pneumatic and hydraulic valves. The M03110 male connector is built to mate with the Series 5000 or other standard MINI female connectors. This connector can be used for mounting on a plate, panel or bulkhead.

#### Features

- 2+ Ground Terminals
- 250V AC/DC max.
- 10 Amps max. rating
- Glass Fiber Reinforced Nylon
- Nitrile Gasket
- Temp. rating -25° to +90° C

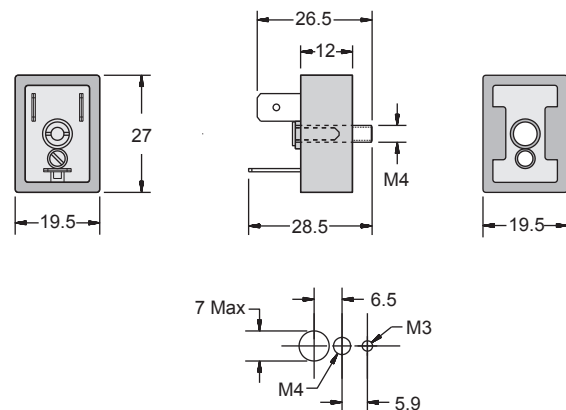

This male DIN 43650 Form "A" / ISO 4400, EN175301-803:2000 connector can be integrated in tooling to provide a cost effective quick connect electrical interface. The P10020 is designed to mate with Series 5000 or other DIN 43650 Form "A" / ISO 4400, EN175301-803:2000 female electrical connectors.

**Features**

- DIN 43650 Form "A" / ISO 4400, EN175301-803:2000 configuration
- 2+ or 3+ Ground versions
- 250V AC/DC max.
- Glass Fiber Reinforced Nylon
- 10 Amps max. rating
- Temp. rating -40° to +125° C

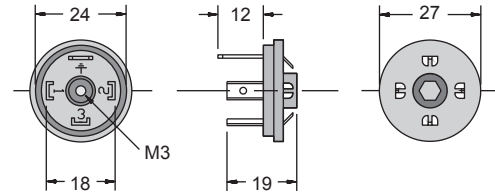

**P10121 ISO Male for 2 Hole Plate Mounting**

This plate mount DIN 43650 Form "A" / ISO 4400, EN175301-803:2000 male connector is offered in either 2+ or 3+ ground versions. Easy to install using the template in the dimensional data. The P10121 connector is designed to mate with Series 5000 or other DIN 43650 Form "A" / ISO 4400, EN175301-803:2000 female connectors.

**Features**

- DIN 43650 Form "A" / ISO 4400, EN175301-803:2000 configuration
- 2+ or 3+ Ground versions
- 250V AC/DC max.
- 10 Amps max. rating
- Glass Fiber Reinforced Nylon
- Nitrile Gasket
- Temp. rating -25° to +90° C
- Panel mounting screws provided

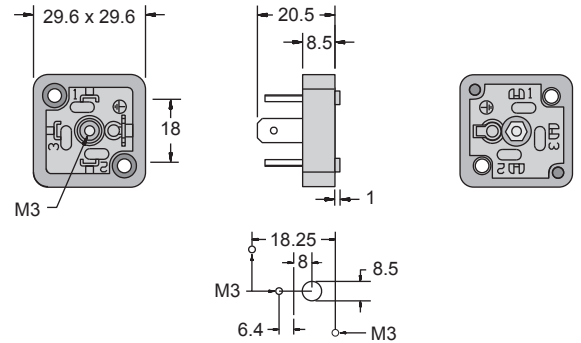

**P10122 ISO Male for 4 Hole Plate Mounting**

This plate mount DIN 43650 Form "A" / ISO 4400, EN175301-803:2000 male connector is offered in either 2+ or 3+ ground versions. Easy to install using the template in the dimensional data. The P10122 connector is designed to mate with Series 5000 or other DIN 43650 Form "A" / ISO 4400, EN175301-803:2000 female connectors.

**Features**

- DIN 43650 Form "A" / ISO 4400, EN175301-803:2000 configuration
- 2+ or 3+ Ground versions
- 250V AC/DC max.
- 10 Amps max. rating
- Glass Fiber Reinforced Nylon
- Nitrile Gasket
- Temp. rating -25° to +90° C
- For high vibration, mobile applications
- Panel mounting screws provided

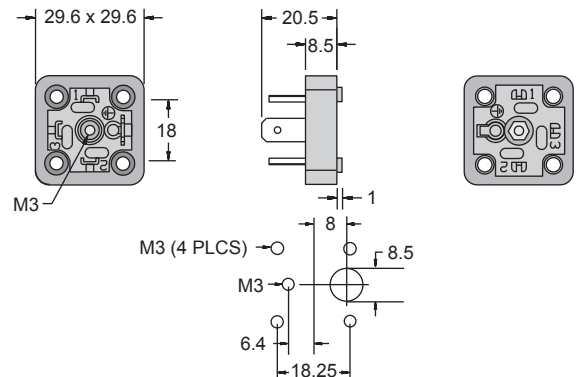

This DIN 43650 Form "A" / ISO 4400, EN175301-803:2000 male connector is specifically designed for mounting in sheet metal. It has an arc over insulating plastic ridge and includes a gasket and four mounting screws. The P10222 connector is designed to mate with Series 5000 or other DIN 43650 Form "A" / ISO 4400, EN175301-803:2000 female connectors.

**Features**

- DIN 43650 Form "A" / ISO 4400, EN175301-803:2000 configuration
- 2+ or 3+ Ground versions
- 250V AC/DC max.
- 10 Amps max. rating
- Glass Fiber Reinforced Nylon
- Nitrile Gasket
- Temp. rating -25° to +90° C

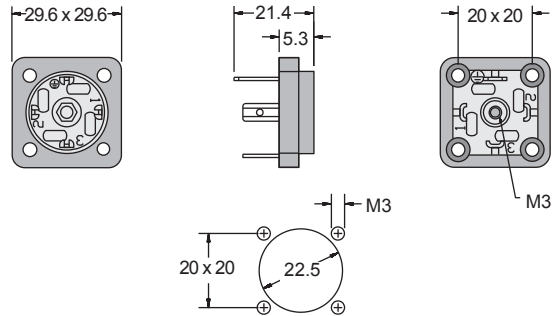

M  
5

This male DIN 43650 Form "A" / ISO 4400, EN175301-803:2000 connector is specifically designed to attach to systems with 1/2" conduit connections and mate with Series 5000 or other DIN 43650 Form "A" / ISO 4400, EN175301-803:2000 female connectors. These units are pre-wired for ease of installation and epoxy encapsulated in an aluminum shell.

**Features**

- DIN 43650 Form "A" / ISO 4400, EN175301-803:2000 configuration
- 2+ or 3+ Ground versions
- 1/2" NPTF Male Thread Connection
- 18 Gauge Wire Standard (6" leads)
- 250V AC/DC max.
- 10 Amps max. rating
- Temp. rating -40° to +105° C

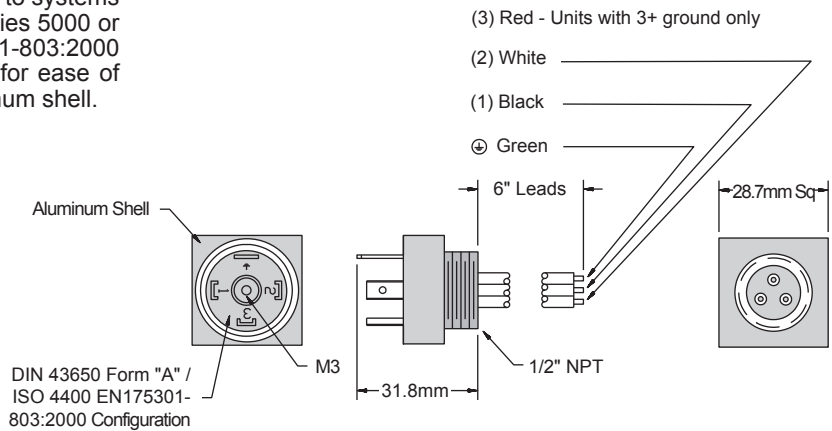

3 plus ground version shown. 2 plus ground version available.

This Sub-Micro 8mm male connector is designed as a small electrical interface that can be molded into other products creating an environmentally protected quick connect interface. The P20020 male connector is designed to mate with Series 5000 8mm female connectors.

**Features**

- 2+ or 3+ Ground versions
- 8mm Centers
- Glass Fiber Reinforced Nylon
- 250V AC/DC max.
- 6 Amps max. rating
- Temp. rating -40° to +125° C

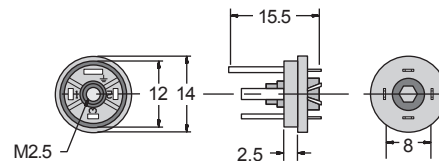

This Sub-Micro 9.4mm male plate mount connector is offered in either 2+ or 3+ ground versions. Easy to install using the template in the dimensional data. The P30120 connector is built to mate with Series 5000 9mm center female connectors.

**Features**

- 2+ or 3+ Ground versions
- 9.4mm Centers
- Glass Fiber Reinforced Nylon
- 250V AC/DC max.
- 6 Amps max. rating
- Nitrile gasket
- Temp. rating -40° to +125° C

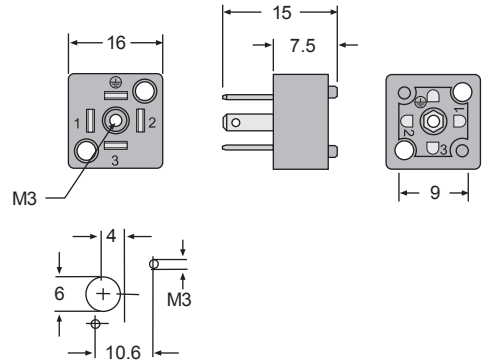

**Ordering Information**

M 5

M 5       -  0 0

Connector Type	
M03010	MINI for molding
M03110	MINI for plate*
P10020	ISO for molding
P10121	ISO for plate 2 hole
P10122	ISO for plate 4 hole
P10222	ISO for sheet metal
P10500	ISO for 1/2" conduit
P20020	Sub-Micro 8mm molding
P30120	Sub-Micro 9.4mm for plate mount

Contacts	
2	2+ ground
3	3+ ground

\* 2+ Ground Terminals Only

Each connector kit contains all mounting hardware.

**Ordering Example:**

M5P10222-300

Model P10222 ISO Male Connector for Sheet Metal with 3+ ground terminals

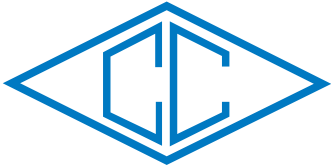

**canfield connector**  
 8510 Foxwood Court  
 Youngstown, Ohio 44514  
 (330) 758-8299 Fax: (330) 758-8912  
 www.canfieldconnector.com

## MODEL MCCR

## MULTIPLE CONTROL CONNECTOR

### General Description

The Canfield Connector MCCR is a cable distribution connector which uses pass-through technology to allow control of multiple parallel or independent devices. Devised with double solenoids and solenoid valve manifolds in mind, the MCCR allows for simplified wiring and easy replacement of components in an automated, modular environment. The gasket-thin head fits between a single female connector and the associated male device with the DIN 43650 Form "A", EN175301-803:2000 interface. Exiting from the MCCR head is a three conductor cable with ISO HT PG9 strain relief connector attached. Two available circuits allow for separate (independent) or parallel (simultaneous) control of the downstream device. The environment resistant quick connect style allows for plug and play designs in the factory that require modern hydraulic or pneumatic systems.

### Dimensional Data

ALL DIMENSIONS ARE IN MILLIMETERS UNLESS OTHERWISE NOTED

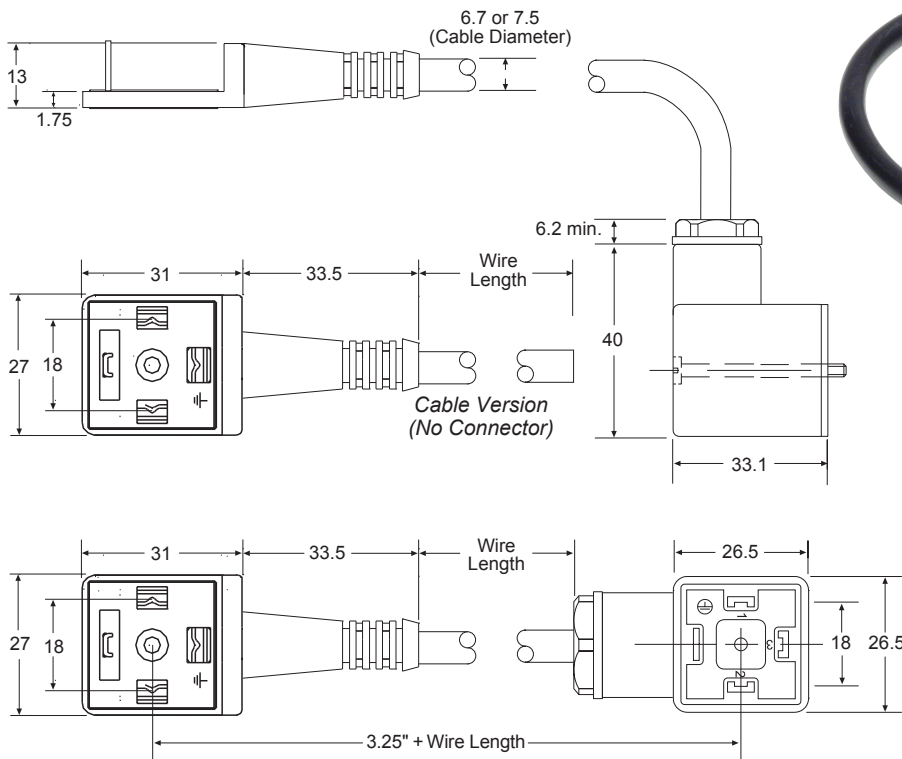

Patent # 6,846,198



Consult factory for available versions listed by Canadian Standards Association for use with certified electrical equipment.

### Features

- Control two solenoids with one connection to controller
- Clean up installation, less wires
- DIN 43650 Form "A"/ISO 4400, EN175301-803:2000 quick disconnect design
- Can control large numbers of coils simultaneously
- Ease of installation and repair
- Incorporated polyurethane seal

### Technical Data

- Maximum current: 10 Amps
- Rated voltage max.: 300 VDC/250 VAC 50/60 Hz
- No. of contacts: 2+ ground  
2+ dual ground
- Degree of protection: NEMA Type 4 and IP65 dust tight and water resistant
- Temperature Range: -40° to 80° C

## Circuit Diagram

Circuit Type #1 and Circuit Type #2  
Separate Control

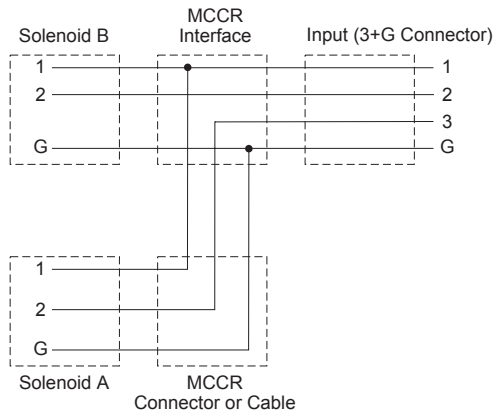

Circuit Type #3  
2+G Parallel Control

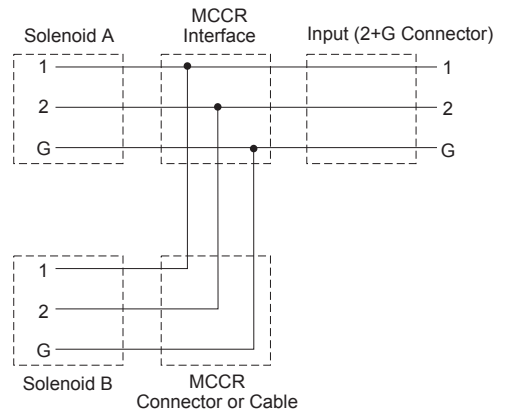

## Applications

Separate Control  
(Circuit Type #1 and Circuit Type #2)

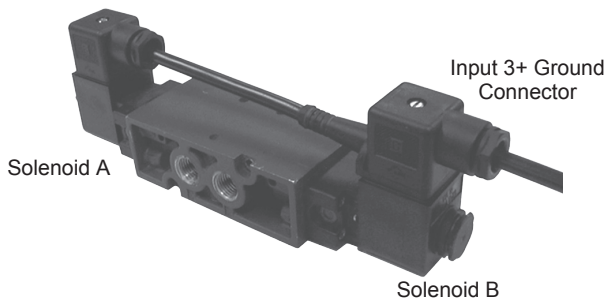

Parallel Control / Simultaneous Solenoid Operation  
(Circuit Type #3)



## Ordering Information

MCCR - [ ] [ ] 1 [ ] [ ] - 1 0

### Wire Length\*\*

- 01 - 1 in.
- 02 - 2 in.
- 03 - 3 in.
- 04 - 4 in.
- 05 - 5 in.
- 06 - 6 in.
- 07 - 7 in.
- 08 - 8 in.
- 09 - 9 in.
- 10 - 10 in.
- 11 - 11 in.
- 12 - 12 in.

\*\*See Dimensional Data Section on Previous Page

### Connector Type\*

- 0 - Cable (no connector)
- 1 - ISO HT PG9 connector (ground up)
- 2 - ISO HT PG9 connector (ground down)

\* For indicator lights and surge suppression, please contact factory

### Circuit Type

- 1 - Separate control ground down
- 2 - Separate control ground up
- 3 - Parallel control 2+dual ground

### Ordering Example:

MCCR-01111-10

Multiple control connector, 1 in. wire length, separate control ground down, ISO HT PG9 connector (ground up)

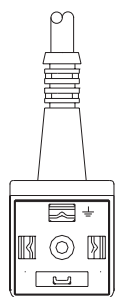

MCCR Ground Up

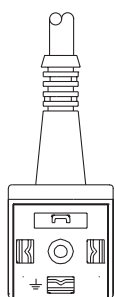

MCCR Ground Down

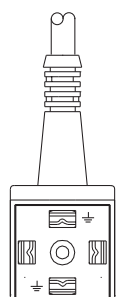

MCCR Dual Ground

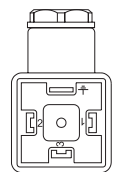

Connector Ground Up

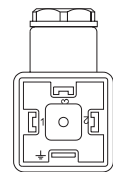

Connector Ground Down

Each connector kit contains fastening hardware and gasket assembly.

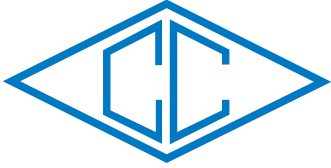

**canfield connector**  
 8510 Foxwood Court  
 Youngstown, Ohio 44514  
 (330) 758-8299 Fax: (330) 758-8912  
 www.canfieldconnector.com

**CANTOP**

**CORD GRIPS**

**General Description**

The Canfield Connector CanTop (brand) is a series of wire bulkhead feed through connectors which have integrated wire strain relief and sealing mechanism. The CanTop (brand) is made from rugged engineered materials which are impervious to dust and moisture. Available in thread sizes NPT 3/8", 1/2", 3/4" and compatible with wire diameters from .157 to .984 (.709 for Flex), the CanTop ensures a tight fit while enhancing any wire installation.

**Dimensional Data**

ALL DIMENSIONS ARE IN MILLIMETERS UNLESS OTHERWISE NOTED

CanTop Strain Relief Connector

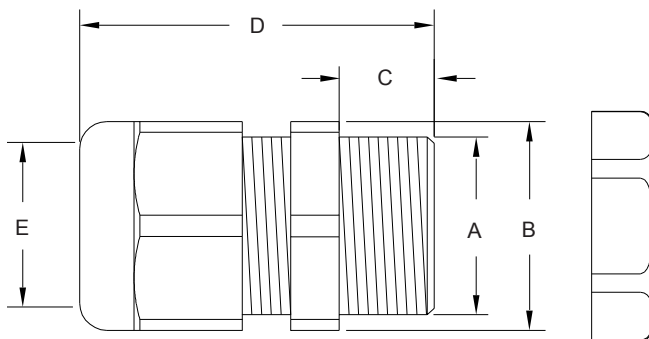

PART NUMBER	DIMENSION				
	A	B (In)	C (In)	D (In)	E Range (In)
CANTOP-S211	NPT 3/8"	0.748	0.591	1.614	0.157-0.315
CANTOP-S221	NPT 3/8"	0.748	0.591	1.614	0.079-0.236
CANTOP-S231	NPT 1/2"	0.945	0.591	1.693	0.236-0.472
CANTOP-S241	NPT 1/2"	0.945	0.591	1.693	0.197-0.354
CANTOP-S251	NPT 3/4"	1.299	0.591	2.047	0.512-0.709
CANTOP-S261	NPT 3/4"	1.299	0.591	2.047	0.354-0.630
CANTOP-S271	NPT 1"	1.614	0.630	2.205	0.709-0.984
CANTOP-S281	NPT 1"	1.614	0.630	2.205	0.512-0.787

CANTOP



CanTop Flex Strain Relief Connector

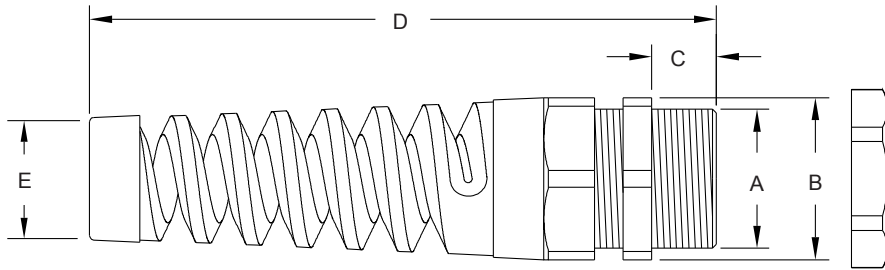

CANTOP

PART NUMBER	DIMENSION				
	A	B (In)	C (In)	D (In)	E Range (In)
CANTOP-F271	NPT 3/8"	0.787	0.591	3.346	0.157-0.315
CANTOP-F281	NPT 3/8"	0.787	0.591	3.346	0.079-0.238
CANTOP-F291	NPT 1/2"	0.945	0.591	4.134	0.236-0.472
CANTOP-F301	NPT 1/2"	0.945	0.591	4.134	0.197-0.354
CANTOP-F311	NPT 3/4"	1.339	0.591	5.079	0.512-0.709
CANTOP-F321	NPT 3/4"	1.339	0.591	5.079	0.354-0.630

**Technical Data**

- Temperature Range: Operational from -40° to +100°C
- All versions designed to meet NEMA 4 / IP65 specifications
- Housing Material - Nylon
- Grommet Material - Neoprene
- Wire Outer Diameter Range - .157" - .984" for Strain Relief  
- .157" - .709" for Flex

**Features**

- Miniature liquid-tight cord grip
- All plastic construction
- Durable and reliable design.
- Corrosion resistant
- Multiple colors available. Consult factory.



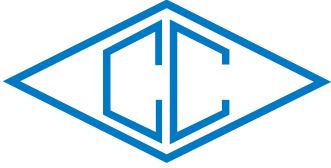

**canfield connector**  
 8510 Foxwood Court  
 Youngstown, Ohio 44514  
 (330) 758-8299 Fax: (330) 758-8912  
 www.canfieldconnector.com

**DCP**

**SOLENOID VALVE  
 DIN COIL PROTECTORS**

**General Description**

The Canfield Connector DCP coil pin protectors are low cost replacements for solenoid connectors that ensure protection of solenoid terminals during shipping and handling. They can also be used to protect spade style terminals on a variety of other products. DCPs are available in a host of colors and styles as well as special logo markings to match the application. Constructed of low cost yet rugged polymers, the DCP adds aesthetic appeal and advertising value to the solenoid valve. There is a DCP available for ISO, industry standard MINI, Sub-Micro, and dual spade hydraulic coils.

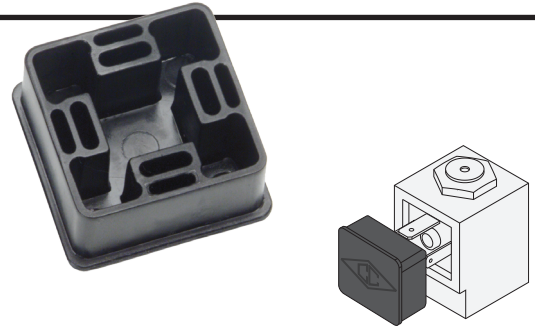

**Dimensional Data**

ALL DIMENSIONS ARE IN MILLIMETERS UNLESS OTHERWISE NOTED

MINI	Sub-Micro
Dual Spade	ISO

**Technical Data**

- Units to fit DIN 43650 Form "A" / ISO 4400, EN175301-803:2000, Industry standard MINI, Sub-Micro and Dual Spade.
- Materials: HDPE
- \*Colors: Many colors available upon request with minimum 20,000 quantity buy.

**Ordering Information**

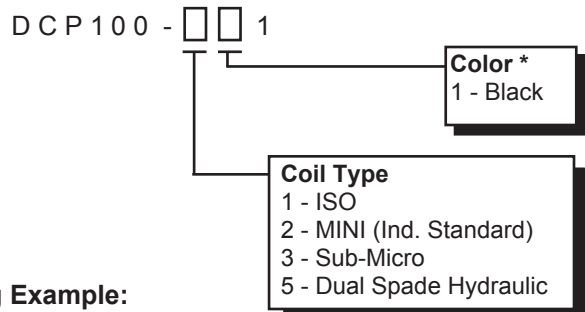

**Ordering Example:**

DCP100 - 111

DIN Coil Protector, ISO, black

*Custom logos available upon request with nominal one time tooling charge and minimum quantity buy of 20,000.*

T O D

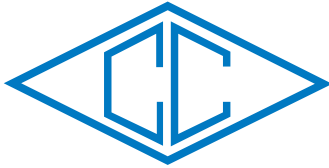

**canfield connector**  
 8510 Foxwood Court  
 Youngstown, Ohio 44514  
 (330) 758-8299 Fax: (330) 758-8912  
 www.canfieldconnector.com

## SERIES 5800 MICRO LOGIC TIMER (MLT)

DIN CONNECTOR WITH  
 INTERNAL TIMER CIRCUIT

### General Description

The Canfield Connector Micro Logic Timer is a solid state electronic timing unit incorporated inside the standard MINI and DIN 43650 Form "A" / ISO 4400, EN175301-803:2000 electrical connectors. The MLT allows precise timing and logic functions in a small, easily mounted enclosure. There are eight standard timer types. Each timer incorporates circuitry for AC or DC operation with a wide voltage range.

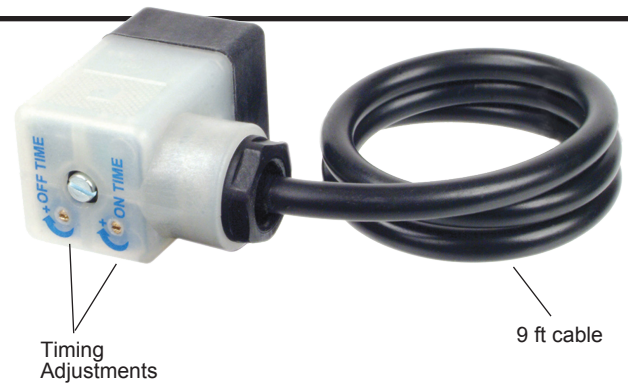

Timing Adjustments

9 ft cable

### Dimensional Data

ALL DIMENSIONS ARE IN MILLIMETERS UNLESS OTHERWISE NOTED

ISO Connector	MINI & ISO Profile View	MINI Connector

### Features

- Makes any logic valve multifunctional
- Easy installation pre-wired timers mount directly to valve
- Built-in surge suppression
- Custom configurations available
- High range of adjustability
- Highly compact design
- Load indicator light, standard
- Interchangeable AC/DC power supply
- NEMA 4 and IP 65 rated
- Polycarbonate Makrolon housing material
- Quick disconnect design
- Timer repeat accuracy +/- 0.5% under normal conditions
- Wide operating voltage range
- 9 ft PVC cable standard



Consult factory for available versions listed by Canadian Standards Association for use with certified electrical equipment.

## Technical Data

- Input Voltage Range: 12-240 VDC  
24-240 VAC (50/60 Hz)
- Maximum timer current draw: 15 mA
- Maximum input voltage tolerance: +/-10%
- Maximum output current: 1 Amp
- Frequency: AC 50/60 Hz or DC
- Ambient temperature range: -20° to +60°C
- 15 turn time adjustment potentiometers for accuracy
- Wire gauge: 20 AWG standard
- Time ranges: 0.1 seconds to 33 minutes in standard versions, other times available upon request

## Timing Diagrams

### Interval Delay/(One Shot)

### Timer Type 1

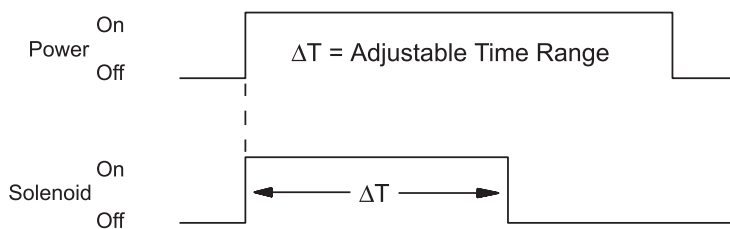

Solenoid is energized for  $\Delta T$  upon application of power. Reset occurs when power is removed.

### On Delay/(Delay On Make)

### Timer Type 2

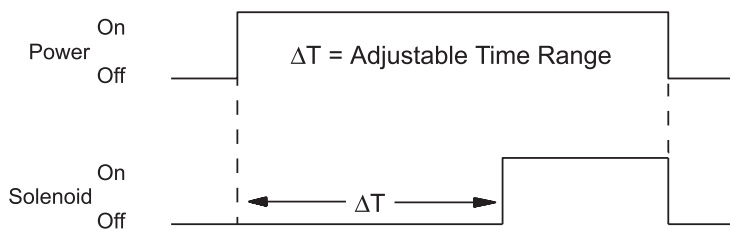

Solenoid remains OFF for  $\Delta T$  upon application of power. Reset occurs when power is removed.

### Off Delay/(Triggered One Shot)

### Timer Type 3

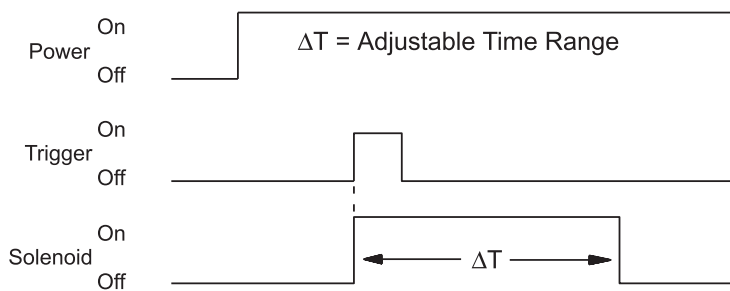

When power is applied, solenoid remains OFF. Solenoid is energized for  $\Delta T$  only upon closure of a normally open momentary contact switch (trigger). Reset occurs when solenoid is OFF and trigger is re-applied.

### Cycle Timer

### Timer Type 4 / Type A

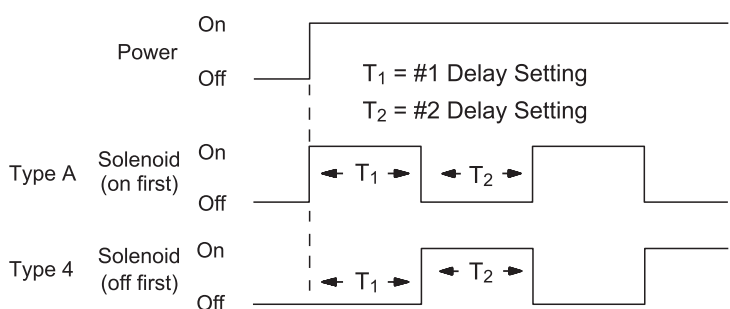

Solenoid cycles  $\Delta T_1$  OFF and  $\Delta T_2$  ON when power is applied. Reset occurs when power is removed. Timer is available in normally on (Type A) or normally off (Type 4) versions.

Square Wave Cycle Timer

Timer Type 5 / Type 9

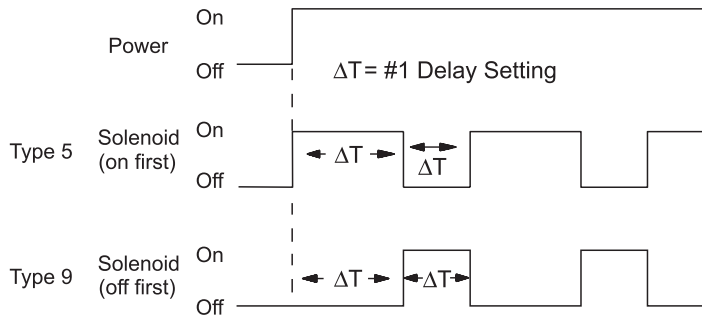

Solenoid cycles with equal ON and OFF times when power is applied. Reset occurs when power is removed. Timer is available in normally on (Type 5) or normally off (Type 9) versions.

Delay On Break Normally Off

Timer Type 6

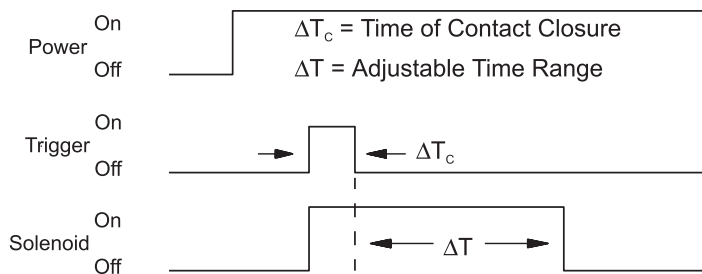

When power is applied, solenoid remains OFF. Solenoid is energized for  $\Delta T_c + \Delta T$  when trigger switch is closed and opened. Reset occurs when solenoid is OFF and trigger is re-applied.

Delay On Break Normally On

Timer Type 7

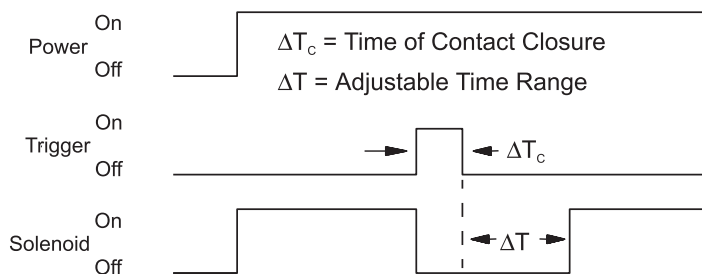

When power is applied, solenoid is energized and remains energized until the trigger switch is closed. Solenoid is then OFF for  $\Delta T_c + \Delta T$ . Reset occurs when solenoid is ON and the trigger is re-applied.

Triggered One Shot Normally On

Timer Type 8

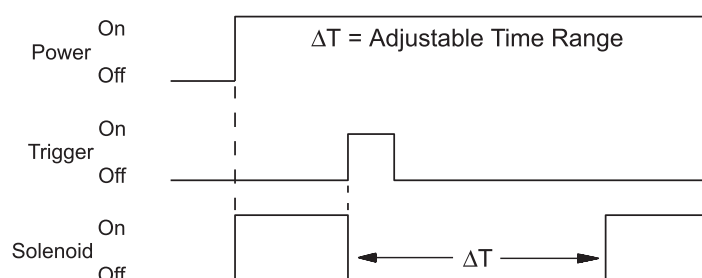

When power is applied, the solenoid is energized. Solenoid de-energizes for  $\Delta T$  only upon closure of a normally open momentary contact switch (trigger). Reset occurs when solenoid is ON and the trigger is re-applied.

Single Cycle Timer

Timer Type B / C

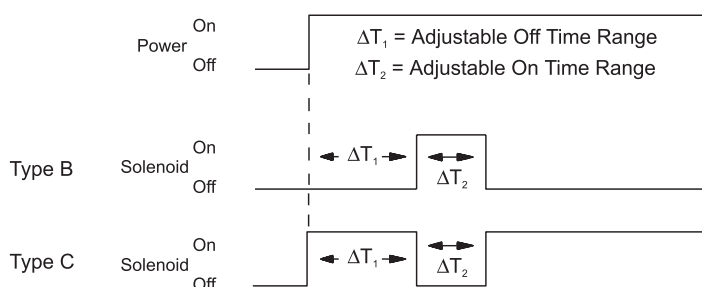

Solenoid cycles  $\Delta T_1$  OFF and  $\Delta T_2$  ON when power is applied. Reset occurs when power is removed. Timer is available in normally off (Type B) or normally on (Type C) versions.

5800

**Ordering Information**

5 8 □ □ - 9 1 0 □ 3

**Timer Type**

- 1 - Interval delay one shot
- 2 - On delay delay on make
- 3 - Off delay triggered one shot
- 4 - Cycle timer normally off
- 5 - Square wave cycle timer normally on
- 6 - Delay on break normally off
- 7 - Delay on break normally on
- 8 - Triggered one shot normally on
- 9 - Square wave cycle timer normally off
- A - Cycle timer normally on
- B - Single cycle timer normally off
- C - Single cycle timer normally on

**Period Delay**

- A - 0.5 to 5 seconds
- B - 0.5 to 25 seconds
- C - 0.5 to 50 seconds
- D - 0.5 to 100 seconds
- E - 2.0 to 20 seconds
- F - 2.0 to 200 seconds
- G - 2.0 to 400 seconds
- H - 5.0 to 50 seconds
- I - 5.0 to 500 seconds
- J - 10.0 to 100 seconds
- K - 10.0 to 1000 seconds
- L - 10.0 to 2000 seconds
- Z - 0.1 to 5 seconds

**Connector Orientation**

- 1 - ISO ground up & down
- 2 - ISO ground right & left
- 3 - MINI ground down
- 4 - MINI ground up

5800

Each kit contains fastening hardware and gasket assembly.

Custom Time Ranges are Available.  
Consult Factory for Details.

**Ordering Example:**

5811-910A3

Interval Delay, ISO ground up & down,  
0.5 to 5 second delay

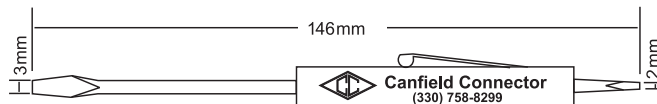

Optional Adjustment Tool  
part # 5000-TOOL

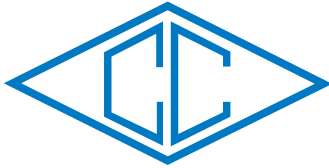

**SERIES 5950**

**MICRO PROPORTIONAL DRIVER**

**General Description**

A Micro Proportional Driver provides accurate control of hydraulic and pneumatic proportional solenoid valves used in mobile construction equipment and industrial processes. The MPD can control the flow of air or liquid linearly at a setting from 0.10-20 seconds. One example of use would be in a paint system. The MPD allows a solenoid to oscillate, significantly reducing system shock and wear commonly found in non-oscillation digital valve systems. The Micro Proportional Driver is a compact electronic circuit built into an environment-resistant miniaturized enclosure. The circuit features control of proportional solenoids and operators. Functions include minimum and maximum current limiting, control signals from 0-10V or 0-20 mA (with a step function at 0.2V or 0.4 mA included for minimum current), a 0.1-20 sec. linear ramp up/ramp down adjustment and output current proportional to input command signal.

This unit incorporates the DIN 43650 Form "A" / ISO 4400, EN175301-803:2000 connector male and female interface. The unit is mounted by use of a single mounting screw, DIN connector and two gaskets. Built to meet NEMA 4 environment standards, the MPD is made from engineered polymers for resistance to harsh chemicals and ingress of water or foreign substances. Adjustments are made on the top surface of the unit. The unit can control any proportional solenoid valve operation within the values specified below using variable pulse width modulation.

**Dimensional Data**

ALL DIMENSIONS ARE IN MILLIMETERS UNLESS OTHERWISE NOTED

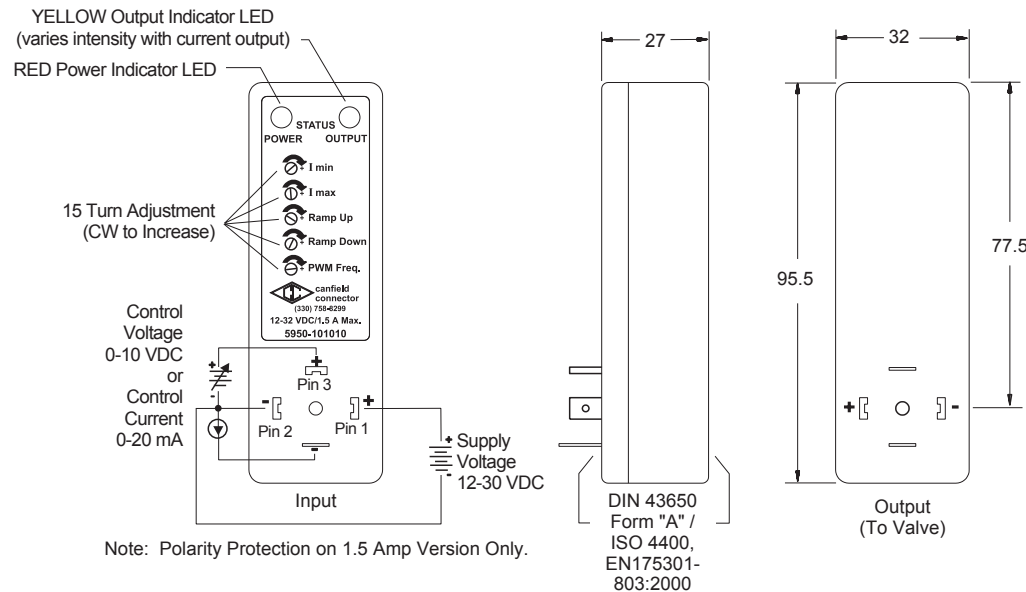

5  
9  
5  
0

**Technical Data**

Parameter	All Versions
Supply Voltage	11.5V DC min. - 32 VDC max.
Supply Current	45 mA max. (no load)
Input Control Signal	
Control Voltage	0 - 10 VDC (500 K $\Omega$ impedance)
Control Current:	0 - 20 mA (100 $\Omega$ impedance)
Regulation $\Delta V$	+/- 0.2% / V
Regulation $\Delta T$	+/- 0.1% / $^{\circ}C$
Ramping Up/Down Time	0.1 - 20 sec. linear (+/- 0.1% / $^{\circ}C$ )
PWM Frequency	95 - 225 Hz
Output Leap to I min.	@ 0.2 V or 0.4 mA control (+/- 15%)
Operating Temp.	-25 to 85 $^{\circ}$ C

Parameter	High Resolution Version	High Output Version
Output Current @ 25 $^{\circ}$ C T <sub>A</sub>		
Continuous	1.5 Amps max.	3.0 Amps max.
Peak Pulsed (16ms)	4.7 Amps max.	17.0 Amps max.
I min. (+/- 20%)	0 - 0.5 Amps max.	0 - 1.0 Amps max.
I max. (+/- 20%)	I min. + 1.0 Amps max.	I min. + 2.0 Amps max.

## Function

**Minimum Current & Maximum Current** - These two adjustments will vary the minimum and maximum output current limits. The minimum current can be set between 0 - 500 mA or 0 - 1 A, depending on output current option. The maximum current can be set in the range between the minimum current setting and the minimum current setting plus 1 A or 2 A, depending on output current option. The minimum current must be set first as described below.

**Minimum Current Adjustment** - Set both min. and max. current adjusters max. counterclockwise. Apply an input command signal of approximately 0.5 volts or 1.0 mA. Adjust the min. current adjuster for a minimum current or to a desired system response. Back up adjuster until system stops responding. Proceed to max. current adjuster.

**Maximum Current Adjustment** - Increase the input command signal to 10 volts or 20 mA. Adjust max. current adjuster for a maximum current limit or to a desired system response.

*Note:* To minimize any effect of supply voltage, load resistance or temperature variation, make setup adjustments when these parameters are at the midpoint of the expected operating range for a particular installation. For example, if

the expected operating temperature range is 20° C to 60° C, make final setup adjustments when system is approximately 40° C. If the supply voltage has a tolerance of 22 to 32 volts, make adjustments when the supply voltage is approximately 27 VDC.

**Ramp Up/Ramp Down** - Adjust to desired ramp up/ramp down time (0.10 - 20 sec.). Ramp time is linear and is proportional to the step change in the control signal. For example: 0.2 - 10 VDC change in control signal gives max. ramp of 20 sec. 0.2-5 VDC change in control signal gives max. ramp of 10 sec.

**PWM Frequency** - The output is pulse-width modulated to control output current within the minimum and maximum current settings. The frequency of the modulation is continuously adjustable from 95 - 225 Hz.

**Output** - The output is current regulated and will remain constant (within the limits specified under Technical Data on previous page) at the level set by the input command signal. Variations in supply voltage and load resistance have little effect as long as these values satisfy the equality stated below.

$$\text{Maximum Required Currents} \leq \frac{\text{Min. Supply Voltage}}{\text{Max. Load Resistance}}$$

## Installation

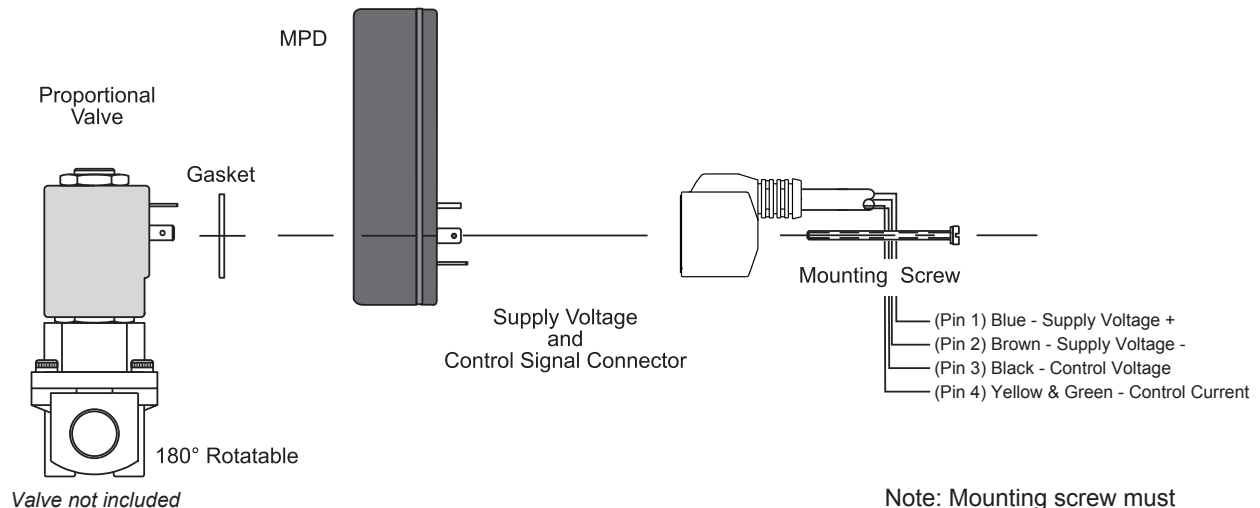

Note: Mounting screw must be securely tightened to meet NEMA 4 standards.

## Ordering Information

### Control Options

- 0 - Control voltage and control current input (no reference voltage output)
- 1 - Control voltage input and reference voltage output (no control current input)

5950 - 10101

### Output Current Options

- 0 - 1.5 Amps max. (high resolution)
- 1 - 3.0 Amps max. (high output)

### Ordering Example:

5950 - 1010100

ISO molded 6 ft. cordset, control voltage and control current input, 1.5 amps max. output



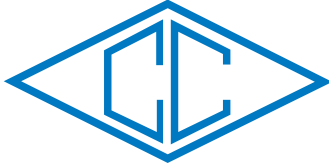

**SERIES B5950**

**BLOCK MICRO PROPORTIONAL DRIVER**

**General Description**

The Canfield Connector Series B5950 is a rugged proportional driver built into an epoxy potted enclosure designed to control linear proportional solenoid operators. Features include selectable control signal inputs from 0-5V or 0-20 mA with adjustable min/max current output. The output steps to the minimum current setting when 0.1V or 0.4 mA is applied to the control signal input. Also included in the compact package is a 0.1 to 20 second adjustable ramp-up and ramp-down output and sine wave dithering (PWM) with adjustable amplitude and frequency. The B5950 has an output current that is proportional to the command signal input.

Assembly and mounting of the unit is accomplished by use of a 6mm diameter mounting hole in the body of the unit. Connection is made by use of a miniature header strip which accommodates stranded or solid wire to 3mm diameter. Adjustments are easily accessible on the top surface of the unit. Additional features include on-board diagnostics such as a red indicator light for power and a yellow indicator light for output to the solenoid. The B5950 can be used to control any solenoid operator designed to meet the technical specifications as shown on this brochure.

**Dimensional Data**

ALL DIMENSIONS ARE IN MILLIMETERS UNLESS OTHERWISE NOTED

(18 Turn Adjustment)  
 Clockwise to  
 Increase All Pots

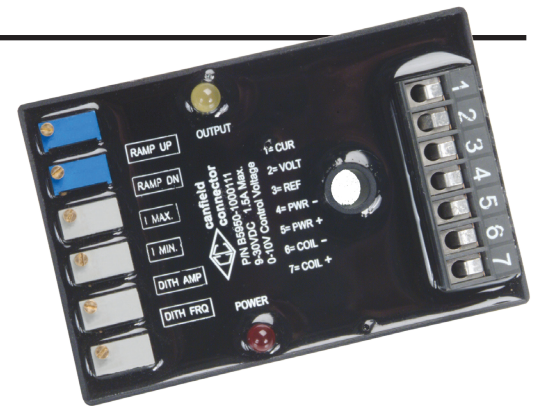
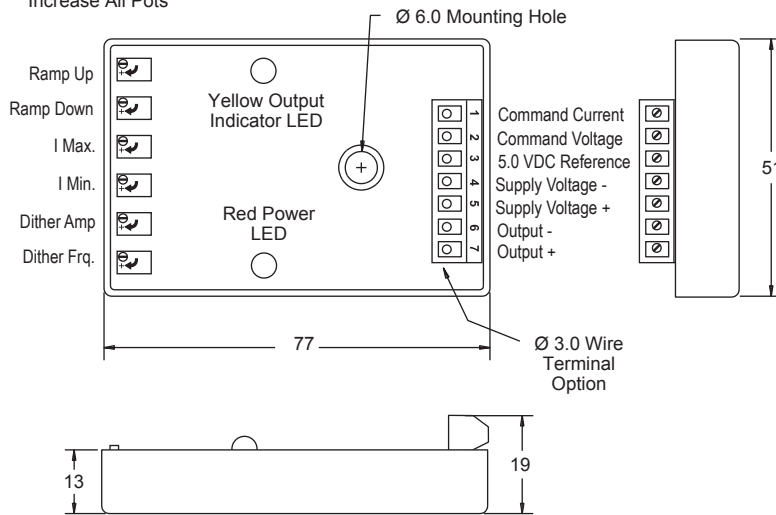

B  
5  
9  
5  
0

**Technical Data**

Parameter	All Versions
Supply Voltage	9.0V DC min. - 32 VDC max.
Supply Current	45 mA max. (no load)
Input Control Signal	
*Control Voltage	0 - 5 VDC (300 K $\Omega$ impedance)
Control Current:	0 - 20 mA (100 $\Omega$ impedance)
Ramping Up/Down Time	0.1 - 20 sec. linear (+/- 0.1% / °C)
PWM Frequency	1.2 KHz fixed
Output Leap to I min.	@ 0.1 V or 0.4 mA control (+/- 15%)
Dithering Frequency	30 -150 Hz
Dithering Aplitude	0 - 500 mA peak to peak
Voltage Reference	5.0V +/- 5% regulated
Operating Temp.	-25 to 85° C

Parameter	High Resolution Version	High Output Version
<b>Output Current @ 25° C T<sub>A</sub></b>		
Continuous	1.5 Amps max.	3.0 Amps max.
Peak Pulsed (16ms)	4.7 Amps max.	17.0 Amps max.
I min. (+/- 20%)	0 - 0.5 Amps max.	0 - 1.0 Amps max.
I max. (+/- 20%)	I min. + 1.0 Amps max.	I min. + 2.0 Amps max.
Regulation $\Delta V$	+/- 0.2% / V	
Regulation $\Delta T$	+/- 0.1% / °C	

\* Also available with 0 - 10 VDC control voltage (see ordering information)

## Function

**Minimum Current & Maximum Current** - These two adjustments will vary the minimum and maximum output current limits. The minimum current can be set between 0 - 500 mA or 0 - 3 A, depending on output current option. The maximum current can be set in the range between the minimum current setting and the minimum current setting plus 1 A or 2 A depending on output current option. The minimum current must be set first as described below.

**Minimum Current Adjustment** - Set both min. and max. current adjusters max. counterclockwise. Apply the minimum input command signal (approximately 0.5 volts or 1.0 mA). Adjust the min. current adjuster for a minimum current or to a desired system response. Back up adjuster until system stops responding. Proceed to max. current adjuster.

**Maximum Current Adjustment** - Increase the input command signal to maximum. Adjust max. current adjuster for a maximum current limit or to a desired system response.

**Note:** To minimize any effect of supply voltage, load resistance or temperature variation, make setup adjustments when these parameters are at the midpoint of the expected operating range for a particular installation. For example, if the expected operating temperature range is 20° C to 60° C, make final setup adjustments when system is approximately 40° C. If the supply voltage has a tolerance of 22 to 32 volts, make adjustments when the supply voltage is approximately 27 VDC.

**Ramp Up/Ramp Down** - Adjust to desired ramp up/ramp down time (0.10 - 20 sec.). Ramp time is linear and is proportional to the step change in the control signal. For example: 0.1 - 5 VDC change in control signal gives max. ramp of 20 sec. 0.1 - 2.5 VDC change in control signal gives max. ramp of 10 sec.

**PWM Frequency** - The output is pulse-width modulated to control output current within the minimum and maximum current settings. The frequency of the modulation is fixed at 1.2 KHz.

**Dither** - The coil current is sine wave modulated with adjustable frequency (30 - 150 Hz) and amplitude (0 - .5A peak to peak).

**Reference Voltage** - A regulated 5.0 VDC voltage is available for on site command voltage. Use of a 10K - 100K potentiometer connected from 5.0 VDC Reference to Supply Voltage (-) is recommended.

**Output** - The output is current regulated and will remain constant (within the limits specified under Technical Data on previous page) at the level set by the input command signal. Variations in supply voltage and load resistance have little effect as long as these values satisfy the equality stated below.

$$\text{Maximum Required Currents} \leq \frac{\text{Min. Supply Voltage}}{\text{Max. Load Resistance}}$$

## Ordering Information

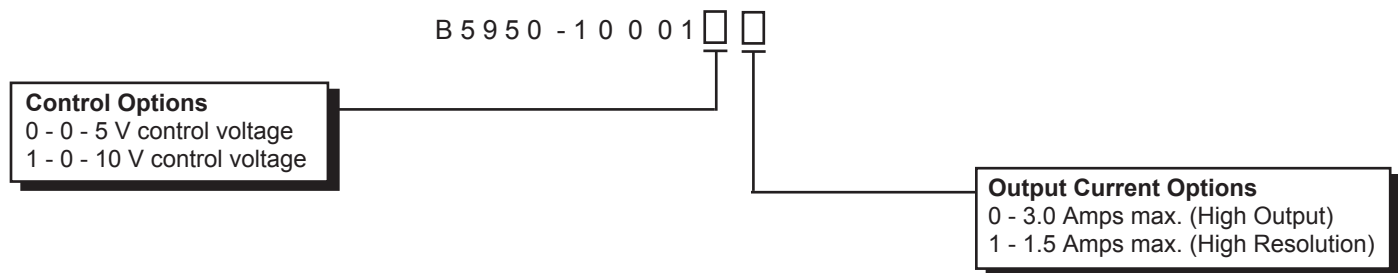

### Ordering Example:

B5950 - 1000100

Block Micro Proportional Driver  
(MPD) 3.0 Amps max

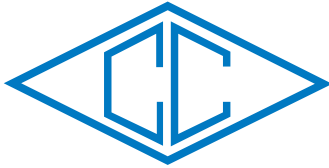

**canfield connector**  
 8510 Foxwood Court  
 Youngstown, Ohio 44514  
 (330) 758-8299 Fax: (330) 758-8912  
 www.canfieldconnector.com

**SANDWICH CRT**

**CONDENSATION REMOVAL TIMER (CRT)**

**General Description**

This Canfield Connector miniature timer makes any valve, with the DIN 43650 Form "A"/ISO 4400, EN175301-803:2000 electrical interface, able to operate as a compressed air system condensate removal valve. The unit installs in a modular form between an existing coil and connector. No new wiring is necessary. Retrofits on virtually any installation. It works with the valve brand of your choice. The cycle and on times are easily adjustable and two indicator lights show status.

**Dimensional Data**

ALL DIMENSIONS ARE IN MILLIMETERS UNLESS OTHERWISE NOTED

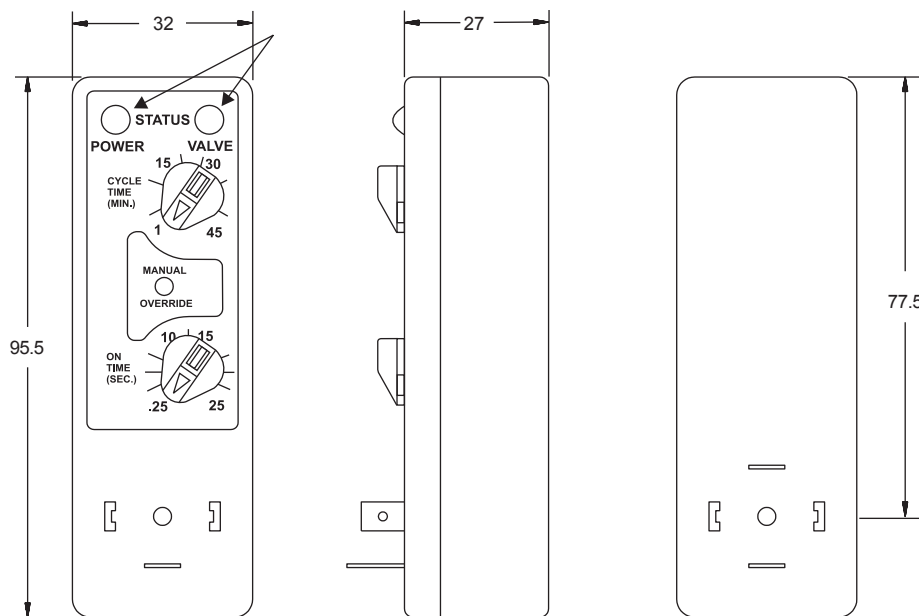

DIN 43650 Form "A" / ISO 4400, EN175301-803:2000 male Connector on Front.

DIN 43650 Form "A" / ISO 4400, EN175301-803:2000 female Connector on Rear. Timer can be rotated 180°.



S  
A  
N  
D

 Consult factory for available versions listed by Canadian Standards Association for use with certified electrical equipment.

Adjust by hand or screwdriver  
 LEDs can be seen from side view.

**Technical Data**

- Voltage ranges: 12 to 60 VDC  
 12 to 240 VAC 50/60 Hz
- Current draw: 1 Amp max. AC  
 1 Amp max. DC
- Ambient temperature range: -20° to +65°C
- ISO DIN interface: DIN 43650 Form "A" / ISO 4400, EN175301-803:2000
- Transient suppression: AC – MOV  
 DC – Diode

**Features**

- Make any valve a condensate removal system
- Environmental protection: dust tight and water resistant
- All solid state; No moving parts to wear
- Indicator lights standard for power and valve status
- Optional 6 ft PVC cable w/grounded plug available
- Manual override switch

## Timer Function

Upon application of power to the input terminals, the OFF time is initiated. At the end of the preset CYCLE time, the solenoid is energized and the ON time begins. At the end of the preset ON time, power is removed from the solenoid and a new cycle begins. Cycling continues until power is removed from the input terminals.

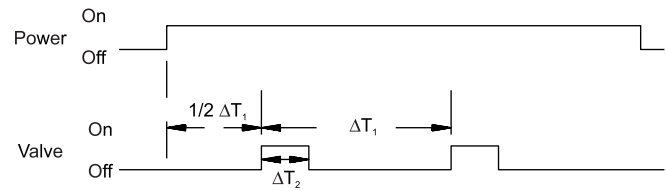

$\Delta T_1$  = Cycle Rate (1 min. to 45 min.)  
 $\Delta T_2$  = Valve ON Time (.25 sec. to 25 sec.)

## Installation

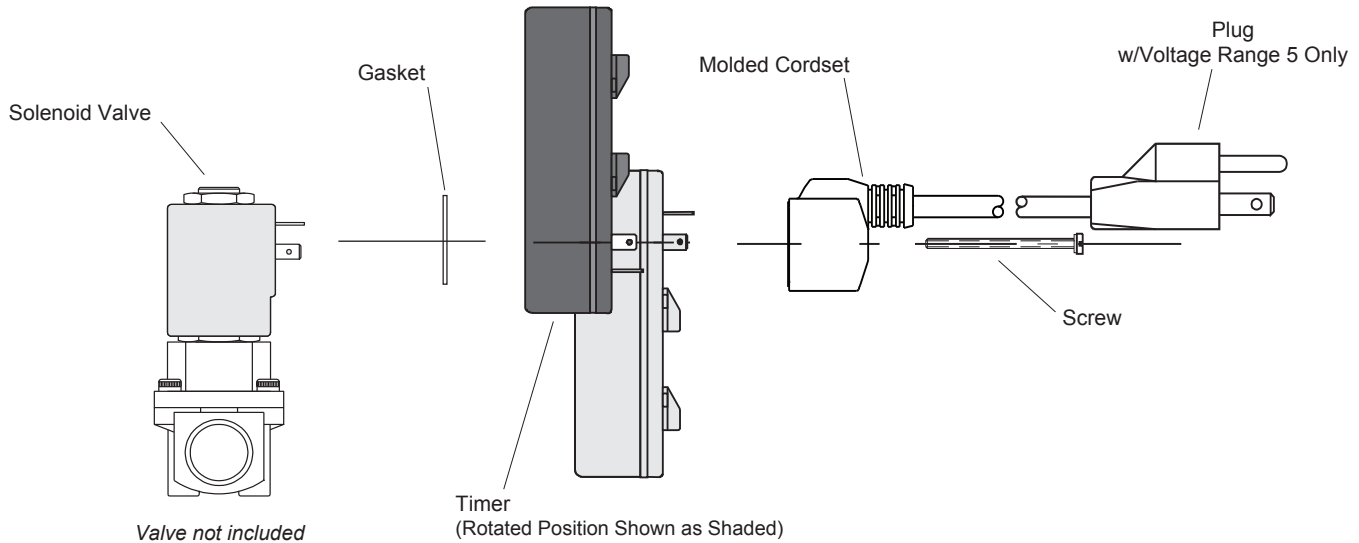

## Applications

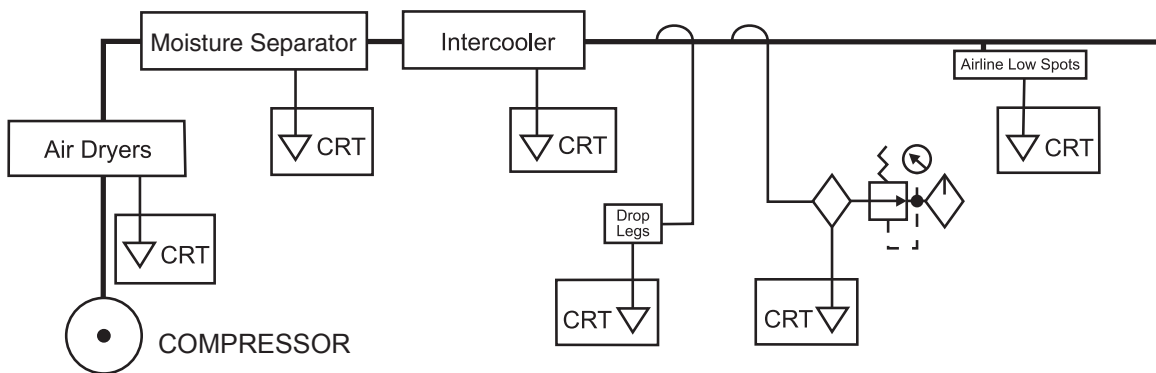

## Ordering Information

**Power Connection**  
 0 - Without molded cordset  
 1 - With molded cordset  
 2 - With ISO 1/2" conduit connector

5940 -  000

**Voltage Range**  
 2 - 12 - 60 VDC  
 4 - 12 - 120 VAC  
 5 - 120 - 240 VAC

**Ordering Example:**

5940 - 10005

Sandwich Timer (CRT) with molded cordset, 120 to 240 VAC

Custom Time Ranges are Available.  
 Consult Factory for Details.

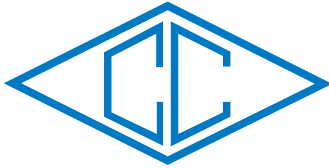

**canfield connector**  
8510 Foxwood Court  
Youngstown, Ohio 44514  
(330) 758-8299 Fax: (330) 758-8912  
www.canfieldconnector.com

## SERIES EOS



TACTILE END OF STROKE PNEUMATIC /  
HYDRAULIC WELD FIELD IMMUNE SENSOR

### General Description

The Canfield Connector EOS differential pressure switch is a compact device used, in place of proximity switches, to sense the end of stroke and/or clamping pressure of a linear actuator. The basic working principle of the EOS is that port "A" and "B" connect in the pressure line between the actuator and the valve. Using a highly accurate differential solid state pressure sensor, the pressures are compared electronically within the EOS. Extremely consistent and repeatable proximity sensing based on reference pressure (from exhaust line) and dependent pressure (from input line) bring an added dimension to end of stroke sensing. The EOS is unaffected by changes in stroke length. Trip points are adjustable based on forces applied by the actuator. This unit is especially useful for clamping various size work pieces, for spot welding applications, or where electronic magnetic proximity devices need to be constantly re-calibrated if the application requires changing trip points. Installation does not require specialized cylinders (i.e. magnetic pistons, special flanged end caps, specialized keyways, or aluminum barrels) and works especially well on short stroke cylinders. The EOS features an analog output for analysis of pressure profiles used in clamping, staking, swaging or welding. This output can be connected to data acquisition or S.P.C. programs for process monitoring and control. The EOS is 100% AC or DC weldfield immune since its function is not dependent on magnetic or electrical fields.



**Patent # 5,585,536**

### Features

- Remote installations / Can be mounted away from the cylinder and work area
- Quick Connect circular electrical connector
- Sub-based pneumatic / hydraulic interface
- Senses proximity in both directions from one unit
- Simple connection between valve and cylinder
- One sensor for both ends of stroke
- Adjustable precise trip points
- Sensing independent of magnetic bands or metal proximity
- Designed for welding operations but can sense any clamping or end of stroke movement
- No electronics affected by stray magnetic fields
- User selectable sinking or sourcing output
- Weld field immune (AC or DC)
- Designed to NEMA 4 environmental protection

### Technical Data

- Supply Volt. Range: 12 - 30 VDC  
24 - 48, 120 VAC
- Supply Current: 20 mA max.
- Current Output: .5 Amps AC / DC
- Analog Output: 3 -5 VDC (4v @ 0 PSI) 5 mA max.
- Sensing Range: 0 to 100 PSI
- Response Time: 10 ms
- Repeatability: +/- 0.1 PSI
- Hysteresis: 4 PSI max.
- Max. Pressure: 200 PSI
- Adjustability: 0.1 PSI
- Temp. Range: -25° to +85°C
- Enclosure Material: Polyetherimide
- Flame Rating: (UL94) V-O
- Media Compatibility: Liquids and gas compatible with glass, ceramic, silicone, RTV and nickel.

## Dimensional Data

ALL DIMENSIONS ARE IN MILLIMETERS UNLESS OTHERWISE NOTED

### Base Module (no sub-base) option 0

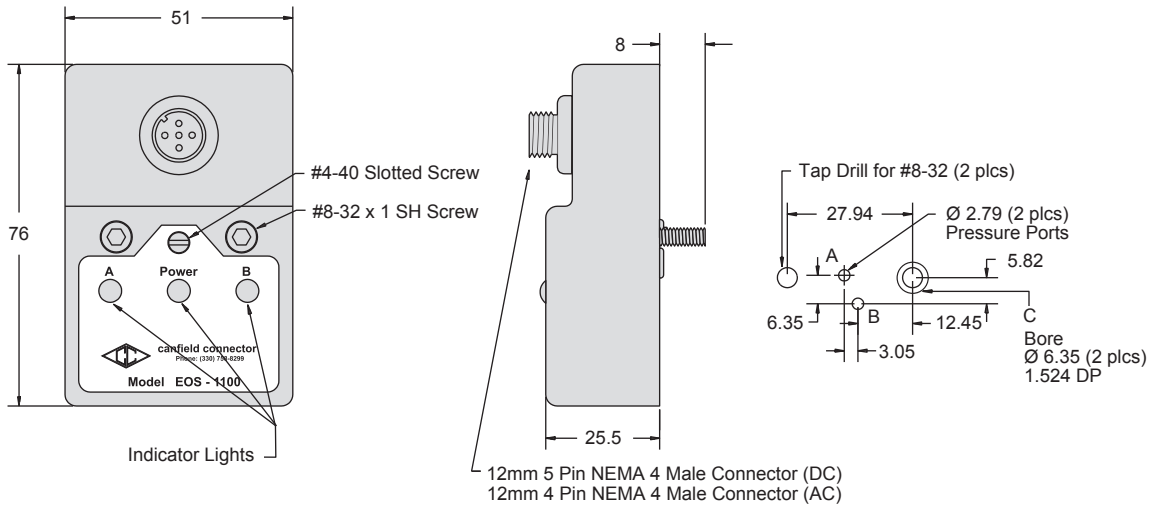

### Base Module and Standard Sub-base option 1

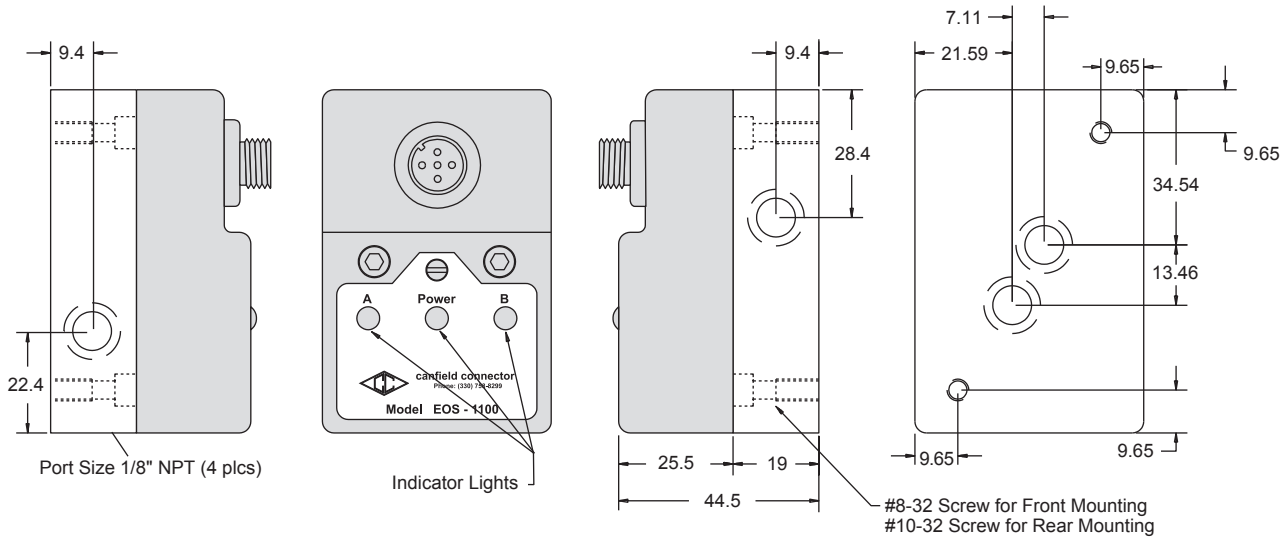

## Typical Application and Installation

Connect Anywhere Between Valve and Cylinder, but for Best Sensitivity Adjustment, Connect Between Cylinder and Flow Control.

Figure 1

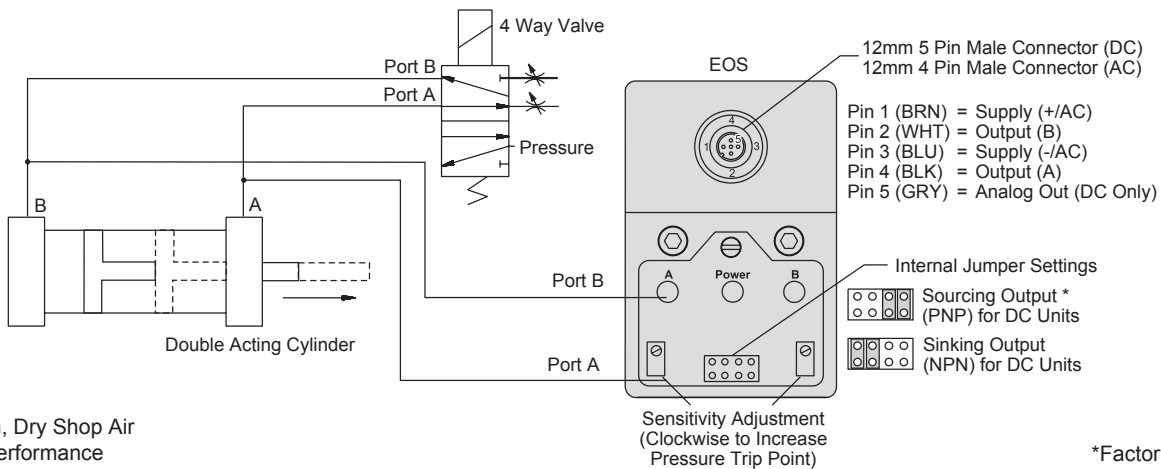

Note:  
Use Clean, Dry Shop Air  
for Best Performance

\*Factory Settings

### Pad Printing

Offset Gravure, commonly known as Pad Printing, uses air valves and cylinders in order to place high quality markings on custom made products. Although there are many configurations of machines, all commonly use a motion which moves the pad down to pick up the ink image. The next motion moves the pad into an up position, then the last motion has the pad moving down again to place the image on the product. Conventional stops and proximity switches are commonly used to accomplish this marking motion as shown by items P.S.1, P.S.2 and P.S.3 in the graphic.

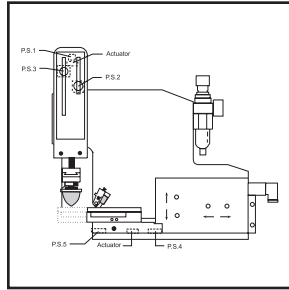

**EOS Advantage:** Replace conventional proximity switches with the EOS. Very important in this process is the pressure applied to the cliché image and then again to the product. The EOS gives +/- 1% repeatability on this force essentially giving the cylinder a tactile “feel”. Since the EOS triggers on precise pad force (independent of proximity), changing work piece height settings are eliminated. The result is highly repeatable images with lower setup costs.

### Material Handling

A pneumatic conveyor system uses the constant flow of low pressure air to move powder material at 3 PSI. Along the way the material often clogs and the flow becomes stopped.

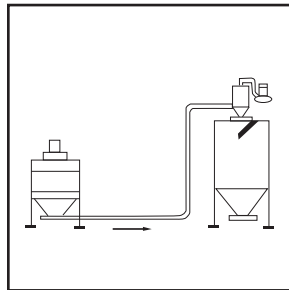

**EOS Advantage:** Large 2 way air valves under high pressure are stationed along the way. The EOS is connected in the upstream and downstream flow of air. If the blockage creates a pressure differential in the line, the EOS senses, trips and sends a signal to the valve to throw a burst of air down the line in just the right area to unstop the clog.

### Riveting

Rivet machines use an anvil and swaging tool in order to join two or more parts together. One manufacturer offers a .250 inch diameter rivet which comes in many lengths from .250 inch to 3.5 inches. In an automated installation a ram cylinder is used to swage the cupped end of the rivet.

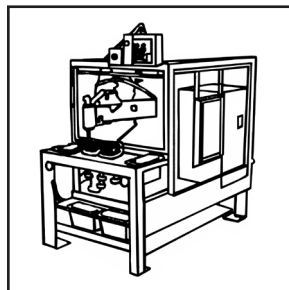

**EOS Advantage:** Changing rivet lengths play havoc with proximity devices which need elaborate adjustment systems in order to sense the ram stroke and deliver the correct amount of force. The EOS ensures consistency of force applied and triggers at the same force every time regardless of rivet length without proximity adjustment.

### Pick and Place

Pick and place machines are a key feature in modern specialized assembly equipment. In fact, these machines are actually dedicated robots which have the responsibility of material handling of products in and out of processing work stations. While these machines vary broadly in their scope, it is a common application to have stacks of paper, metal slabs or for the use of our example, printed circuit boards (PCBs) waiting in a que to be used by the work cell. In the queuing area for a PCB assembly machine, PCBs are stacked one on top of the other. A pick and place robot feeds the PCBs one at a time into the equipment as is needed. An expensive DC drive mechanism is used in order to present the PCB to the exact height the pick and place robot needs in order to acquire it properly.

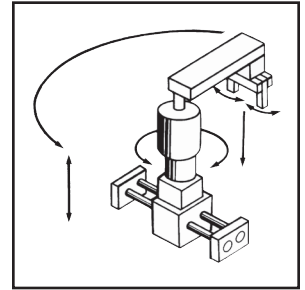

**EOS Advantage:** Using a pick and place robot equipped with a cylinder and EOS combination saves time and is more forgiving to variations in workplace height. The Z axis cylinder becomes positioned over the PCB stack which is stationary. The cylinder extends toward the PCB until the EOS senses that the proper preset force (tactile) is met and grasps the top PCB regardless of stack height. The EOS switches sending a signal immediately back to the control whereby the cylinder retracts and feeds the PCB into the machine. The next cycle repeats and the EOS senses regardless of stroke length until the last PCB is removed.

### Wire Terminal Crimping

A well known maker of wire harnesses for automobiles cuts, strips and terminates wires in several operations on automated machinery. The problem was that their crimping tools would often times crush the terminations or not apply enough force to ensure a good continuity and crimp connection.

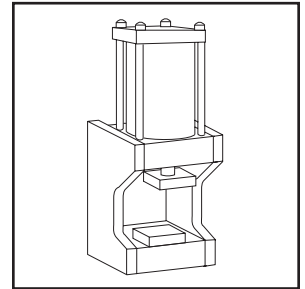

**EOS Advantage:** By applying the EOS to the ram cylinders of the termination presses, crimp forces were brought under control and quality of the process was attained. Now the machines apply the same force each time regardless of fluctuations in input pressures.

### Field Service Indicator for Air Filters

Many air systems need clean, consistent air quality for instrumentation and working components.

**EOS Advantage:** Connection of the EOS in the upstream (port A) and downstream (port B) will sense differentials of pressures and trigger when the pressure reaches a set point indicating electronically when filters are becoming obstructed with debris.

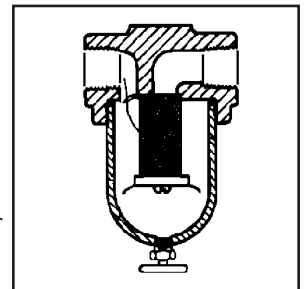

### Resistance Welding

Many resistance welders used in the automotive industry rely on proximity devices in order to sequence the force, time and current needed to produce welds.

**EOS Advantage:** Since the EOS adjusts to finite triggering based on cylinder (tactile) force, precise trip points based on those forces save time to weld. The reason for this is that the weld can be accomplished without the need to add time frames for flow restrictions and pressure drops inherent in each system. The EOS also remains unaffected by weld fields as the principle of operation and does not use magnetism or inductive sensing. Additionally, differing thicknesses of metals and weld tip erosion can not change the trip points of the EOS. The EOS can be mounted either at or away from the cylinder. The EOS will not trip in low pressure situations as proximity sensors would ensuring quality welds. The EOS is also available with an SPC output in the DC version. Pressure profiles can be fed back into a computer data acquisition terminal where the pressure profiles for each individual weld can be stored for quality assurance.

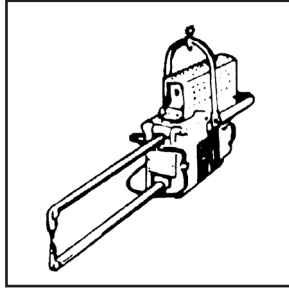

### Automatic Door Closing and Obstacle Sensing

Some doors and covers which are used to separate rooms in plants or sections of machinery are closed by use of air cylinders.

**EOS Advantage:** An EOS attached to the circuit replaces electric eyes and tape switches. Setting the EOS to the proper force, an obstacle of varying sizes can be placed anywhere along the path of the door. A resistance great enough to create a pressure differential signals the control that an obstacle is in the way of normal travel which in turn reverses the travel of the door. A conventional proximity device is in place at the end of the door travel which negates the EOS output and signals to the control that the door is in fact closed. The EOS gives the door a tactile response. In this application the EOS is simply a single component of a more elaborate safety system.

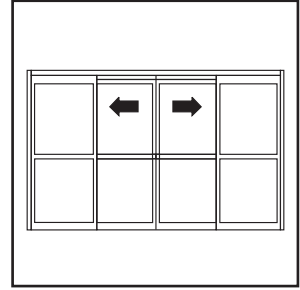

### How It Works

Refer to Schematic (Figure 1) and Graph (Figure 2).

- 1.) Four way valve shifts switching pressure from port "A" to port "B".
- 2.) Pressure builds in line "B" and drops in line "A" until cylinder load / friction are overcome.
- 3.) Dependent upon the response time and valve flow, "B" line pressure exceeds "A" line pressure.
- 4.) Friction / load overcome, cylinder travel begins.
- 5.) End of stroke or clamping force begins, "B" line pressure increases and "A" line pressure decays.
- 6.) When the pressure differential between port "A" and "B" ( $B \text{ PSI} - A \text{ PSI} = \Delta p$ ) increases to the preset trip point output "B" will activate.

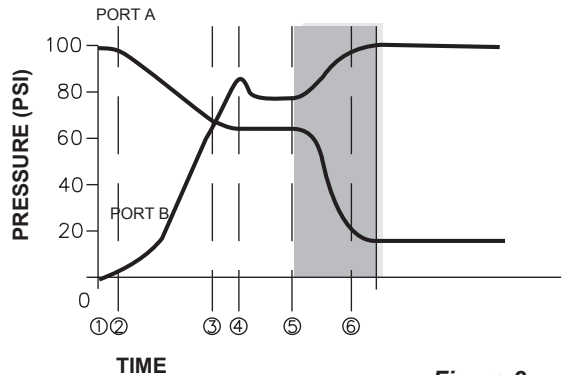

Figure 2

The sensor can be set to trip anywhere in the shaded region depending on desired clamping force and/or delay.

### Ordering Information

**Supply Voltage**  
 1 - 12-24 VDC  
 2 - 24-48 VAC \*  
 3 - 120 VAC \*

EOS - 1

**Cordset**  
 0 - Without cordset  
 1 - With 6 ft straight female cordset  
 2 - With 6 ft 90° female cordset

**Module Style**  
 0 - Module only  
 1 - Module and standard sub-base

**Ordering Example:**  
 EOS-1111  
 12-24 VDC, module and subbase,  
 6 ft. straight female cordset

\* AC voltage versions are not available with analog output



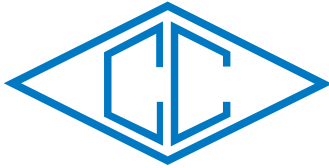

**canfield connector**  
8510 Foxwood Court  
Youngstown, Ohio 44514  
(330) 758-8299 Fax: (330) 758-8912  
www.canfieldconnector.com

## MODEL EOS-2



## TACTILE END OF STROKE PNEUMATIC AND HYDRAULIC SENSOR

### General Description

The Canfield Connector EOS differential pressure switch is a compact device used in place of proximity switches to sense the end of stroke and/or clamping pressure of a linear actuator. Sensing the pressure on the exhaust and pressure side of the double acting cylinder enables the EOS to determine when the end of stroke is reached. The end of stroke is determined based on pressure, not proximity. Trip points are adjustable based on forces applied by the actuator. This unit is especially useful in applications with inconsistent size work pieces, clamping, staking, swaging, welding or where electronic magnetic proximity devices do not work as well. The EOS can replace proximity devices on applications where these devices are used to sense end of stroke. Installation is easier than standard proximity devices and cylinders can be made of any material. Cylinders need not incorporate any magnetic pistons or special flanged end caps.



### Dimensional Data

ALL DIMENSIONS ARE IN MILLIMETERS UNLESS OTHERWISE NOTED

#### On-Board Adjust

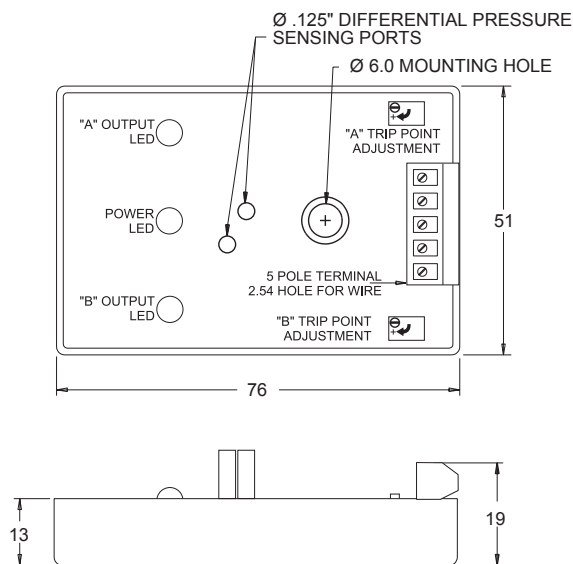

#### Off-Board Adjust

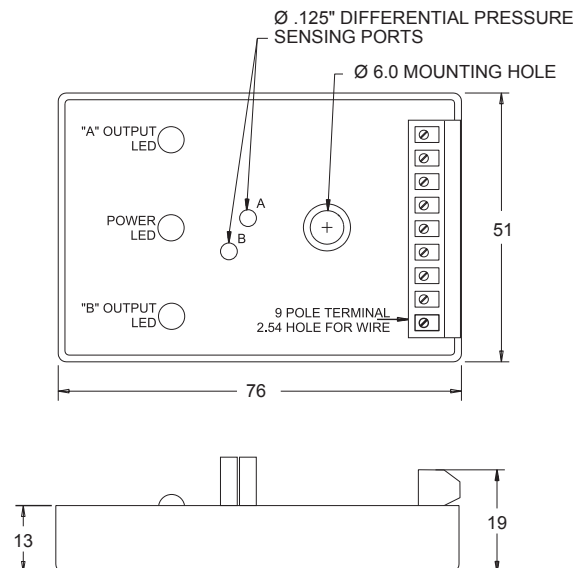

### Technical Data

- Supply Voltage Range: 12 - 30 VDC / 24-48, 120 VAC
- Supply Current: 20 mA max.
- Current Output: .5 Amps AC / DC
- Analog Output: 3-5 VDC (4V @ 0 PSI) 5 mA max.
- Sensing Range: 0 to 100 PSI
- Response Time: 10 ms
- Repeatability: 0.1 PSI
- Hysteresis: 4 PSI max.
- Max. Pressure: 200 PSI
- Adjustability: 0.1 PSI
- Temperature Range: -25° to +85°C
- Enclosure Material: ABS, Epoxy
- Flame Rating: (UL94) V-O
- Media Compatibility: Liquids and gas compatible with glass, ceramic, silicone, RTV and nickel

## How It Works

Refer to Schematic (**Figure 1**) and Graph (**Figure 2**).

- 1.) Four way valve shifts switching pressure from port "A" to port "B".
- 2.) Pressure builds in line "B" and drops in line "A" until cylinder load / friction are overcome.
- 3.) Dependent upon the response time and valve flow, "B" line pressure exceeds "A" line pressure.
- 4.) Friction / load overcome, cylinder travel begins.
- 5.) End of stroke or clamping force begins, "B" line pressure increases and "A" line pressure decays.
- 6.) When the pressure differential between port "A" and "B" ( $B \text{ PSI} - A \text{ PSI} = \Delta\pi$ ) increases to the preset trip output point "B" will activate.

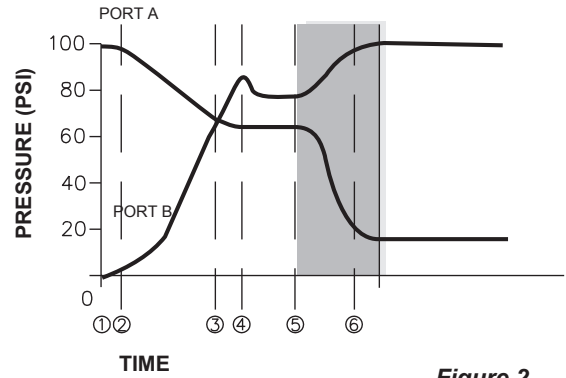
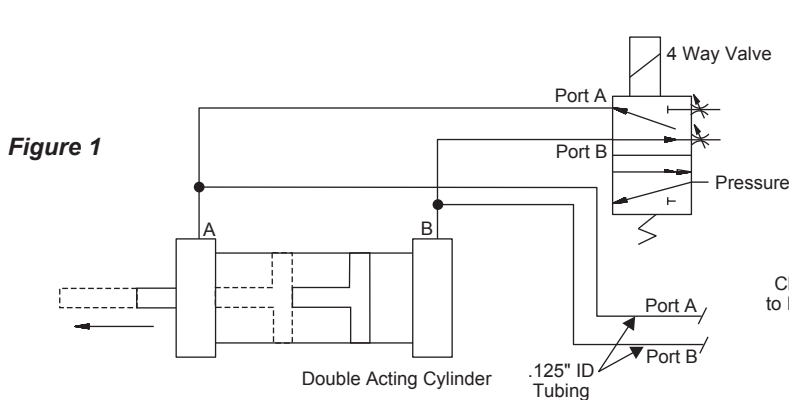

**Figure 2**

The sensor can be set to trip anywhere in the shaded region depending on desired clamping force and/or delay.

## Typical Application and Installation for Remote Adjust

Connect Anywhere Between Valve and Cylinder, but for Best Sensitivity Adjustment, Connect Between Cylinder and Flow Control.



**Figure 1**

**Note:**  
Use Clean, Dry Shop Air  
for Best Performance

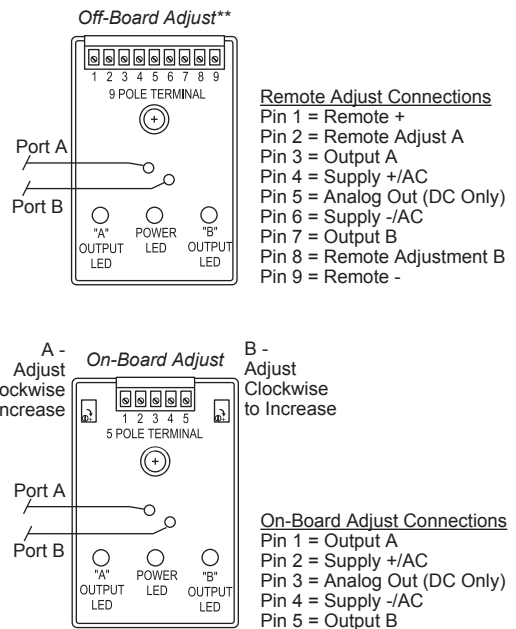

## Ordering Information

**Supply Voltage/Output Type**

- 1 - 12-24 VDC / NPN (sinking)
- 2 - 12-24 VDC / PNP (sourcing)
- 3 - 24-48 VAC / triac \*
- 4 - 120 VAC / triac\*

EOS - 2 0

**Module Style**

- 0 - With on-board adjustments
- 1 - With off-board adjustments

**Ordering Example:**

EOS-2110

12-24 VDC / NPN (sinking),  
with off-board adjustments

\* AC voltage versions are not available with analog output.

\*\* Customer must supply two 100k ohm potentiometers. Shielded cable is recommended for remote potentiometer hook-up.

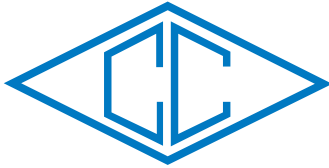

**canfield connector**  
 8510 Foxwood Court  
 Youngstown, Ohio 44514  
 (330) 758-8299 Fax: (330) 758-8912  
 www.canfieldconnector.com

## MODEL MBT

## MULTIFUNCTION BLOCK TIMER 12 FUNCTIONS IN 1 TIMER

### General Description

The Canfield Connector model MBT Multifunction Block Timer is designed as a full featured multiple mode of operation, multiple voltage, all-in-one timer. The unit is offered in a small epoxy encapsulated housing with on board mode switches and adjustments. The unit has a time range adjustable from 0.1 seconds to 33.3 hours. Features include twelve modes of operation including a multitude of logic function possibilities and an indicator light for fast troubleshooting. The unit can be used to trigger another MBT in a cascade type arrangement, to meet complex functions or longer time ranges. With a voltage range of 12-240 VDC / 24-240 VAC 50/60 Hz, the MBT can instantly handle all mobile, industrial and automation applications right off the shelf. Each timer is 100% tested for function and quality and is resistant to dust, vibration and humidity. Mounting is accomplished by use of a through hole able to accommodate up to a 6mm diameter screw. Electrical connections are .250" AMP Fasten posts for crimp type push-on connectors.

### Dimensional Data

ALL DIMENSIONS ARE IN MILLIMETERS UNLESS OTHERWISE NOTED

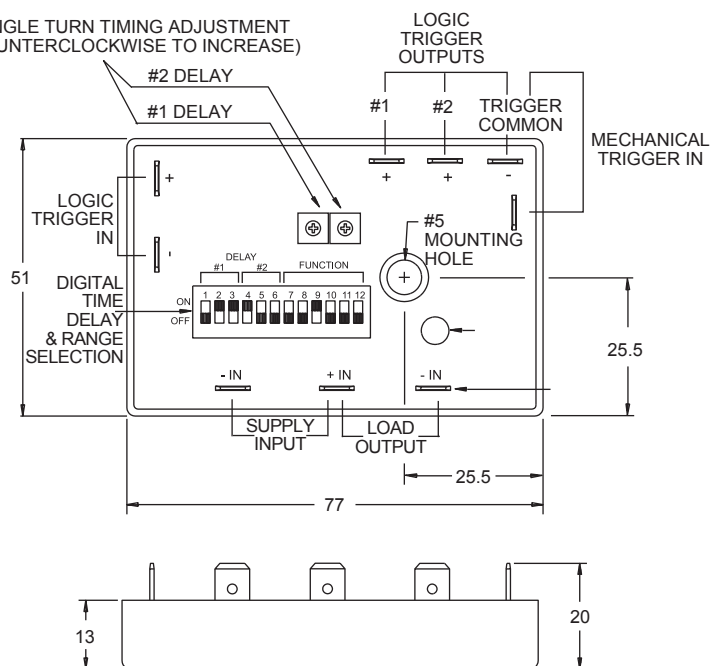

M  
B  
T

### Features

- All solid state
- 12-240 Volts in one unit
- Time range .1 sec. to 33.3 hours
- Indicator light
- Transient protection
- Stock one timer for all functions
- Fasten connections
- Cascade trigger
- 12 timing modes in one unit
- On board adjustment

### Technical Data

- Maximum timer current draw: 2 mA (No Load)
- Absolute max. input voltage: 240V AC/DC
- Input voltage range: 24-240 VAC (50/60Hz)  
12-240 VDC
- Maximum output current: 1 Amp
- Logic trigger in: 5-48 VDC (10k input impedance)
- Logic trigger out: 5.5 V @ .55 mA max.
- Mechanical trigger in: 80 mA max. current draw
- Ambient temp. range: -20° to +60°C
- Max. reset time: 50 ms
- Repeat accuracy: ± 0.1% or 10 ms.  
(whichever is greater)
- Time delay variable over ambient temp. range: +/- 2%
- Enclosure material: ABS
- Potting: Epoxy

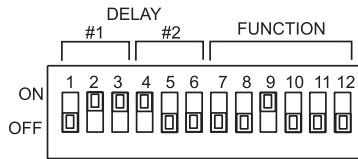

Switch Symbols

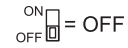
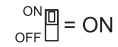

Chart 1

#1 Delay Range (seconds) All Function	Switch Settings
.10 - 4.70	ON 1 2 OFF 0 0
0.36 - 18.0	ON 1 2 OFF 0 0
2.80 - 150	ON 1 2 OFF 0 0
23.0 - 1200	ON 1 2 OFF 0 0
Delay = range X 1	ON 3 OFF 0
Delay = range X 100	ON 3 OFF 0

Chart 2

#2 Delay Range (seconds) Cycle Function Only	Switch Settings
0.10 - 4.70	ON 4 5 OFF 0 0
0.36 - 18.0	ON 4 5 OFF 0 0
2.80 - 150	ON 4 5 OFF 0 0
23.0 - 1200	ON 4 5 OFF 0 0
Delay = range X 1	ON 6 OFF 0
Delay = range X 100	ON 6 OFF 0

Chart 3

Function	Switch Settings
#1 Off delay (retriggerable)	ON 7 8 9 10 11 12 OFF 0 0 0 0 0 0
#2 On delay (retriggerable)	ON 7 8 9 10 11 12 OFF 0 0 0 0 0 0
#3a Cycle (on first)	ON 7 8 9 10 11 12 OFF 0 0 0 0 0 0
#3b Cycle (off first)	ON 7 8 9 10 11 12 OFF 0 0 0 0 0 0
#4a Square wave (on first)	ON 7 8 9 10 11 12 OFF 0 0 0 0 0 0
#4b Square wave (off first)	ON 7 8 9 10 11 12 OFF 0 0 0 0 0 0
#5 Delay on break (normally off)	ON 7 8 9 10 11 12 OFF 0 0 0 0 0 0
#6 Delay on break (normally on)	ON 7 8 9 10 11 12 OFF 0 0 0 0 0 0
#7 Delay on make (normally off)	ON 7 8 9 10 11 12 OFF 0 0 0 0 0 0
#8 Delay on make (normally on)	ON 7 8 9 10 11 12 OFF 0 0 0 0 0 0
#9a Toggle (on first)	ON 7 8 9 10 11 12 OFF 0 0 0 0 0 0
#9b Toggle (off first)	ON 7 8 9 10 11 12 OFF 0 0 0 0 0 0

Operation

**General Description** - The MBT is a solid state timer/ toggle latch, programmable in 12 modes of operation (refer to chart 3). It can be operated individually or cascaded to perform virtually any timing sequence desired.

**Mechanical Trigger Input** - A switch closure at this input begins or resets the timing period of any non-cycling MBT function. Refer to pages 61-62 for timing diagrams.

**Logic Trigger Input** - A sourcing or sinking voltage signal (5 - 48 volts) at this input begins or resets the timing period of any non-cycling MBT function. Refer to pages 61-62 for timing diagrams.

**Logic Trigger Outputs** - The logic output produces a voltage signal in sync with the timing cycle (see timing diagrams, pages 61-62). Timers can be cascaded when the logic output of one timer is connected to the logic input of other timers. The logic signal output is inactive when power is initially applied to the timer. The #1 logic output produces a voltage level opposite the #2 logic output.

**Cascading Multiple Timers** - There is no limit to the number of MBTs that can be cascaded in series (the logic output of one MBT connected to the logic input of another MBT). However the number of parallel MBTs (the same logic output connected to the logic input of more than one other MBT) should be limited to 10 MBTs.

MBT

Off Delay (Retriggerable) Function #1

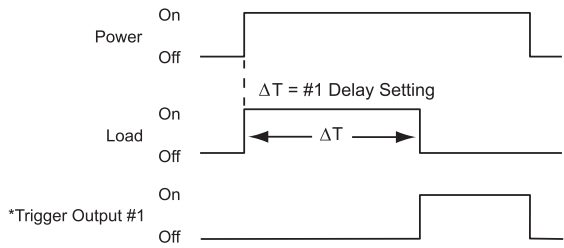

Load is energized for  $\Delta T$  upon application of power. Reset occurs when power is removed or trigger is applied.

Refer to charts 1 and 3 on page 60 for switch settings.

\*Trigger Output #2 level is always opposite of Trigger Output #1.

On Delay (Retriggerable) Function #2

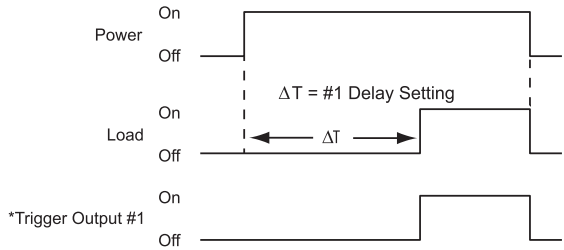

Load remains Off for  $\Delta T$  upon application of power. Reset occurs when power is removed or trigger is applied.

Refer to charts 1 and 3 on page 60 for switch settings.

\*Trigger Output #2 level is always opposite of Trigger Output #1.

Cycle Function #3a / 3b

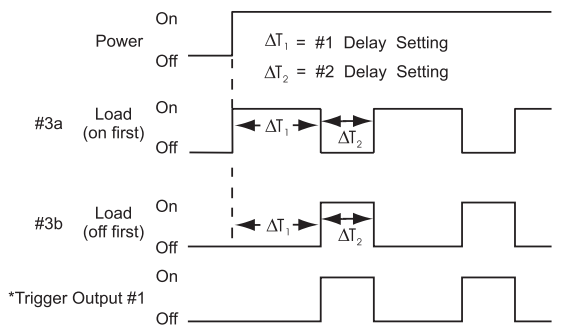

Load cycles  $\Delta T_1$  and  $\Delta T_2$  when power is applied. Reset occurs when power is removed.

Refer to charts 1, 2 and 3 on page 60 for switch settings.

\*Trigger Output #2 level is always opposite of Trigger Output #1.

Square Wave Function #4a / 4b

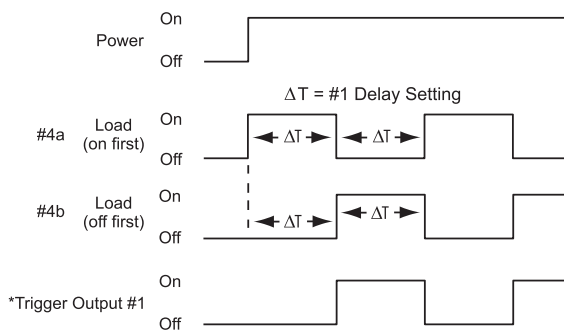

Load cycles with equal On and Off times when power is applied. Reset occurs when power is removed.

Refer to charts 1 and 3 on page 60 for switch settings.

\*Trigger Output #2 level is always opposite of Trigger Output #1.

Delay On Break (Normally Off) Function #5

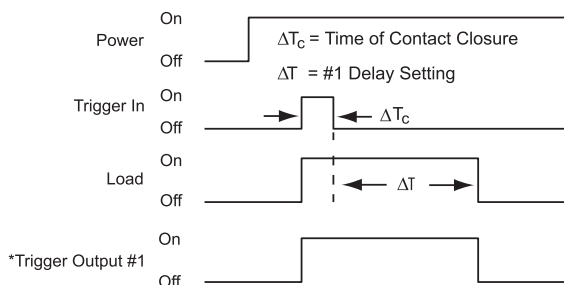

When power is applied, load remains Off. Load is energized when trigger switch is closed. When trigger switch is opened,  $\Delta T$  begins. The load de-energizes at completion of  $\Delta T$ . Reset occurs when load is Off and trigger is re-applied.

Refer to charts 1 and 3 on page 60 for switch settings.

\*Trigger Output #2 level is always opposite of Trigger Output #1.

Delay On Break (Normally On)

Function #6

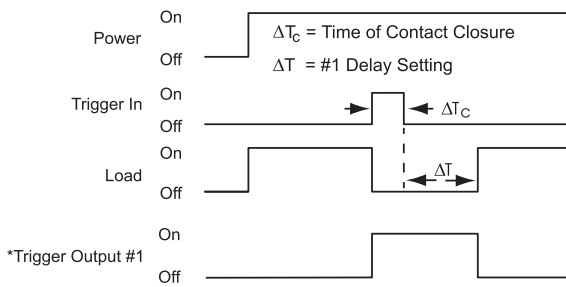

When power is applied, load is energized and remains energized until the trigger switch is closed. Load is then Off for  $\Delta T_C + \Delta T$ . Reset occurs when load is On and the trigger is re-applied.

Refer to charts 1 and 3 on page 60 for switch settings.

\*Trigger Output #2 level is always opposite of Trigger Output #1.

Delay On Make (Normally Off)

Function #7

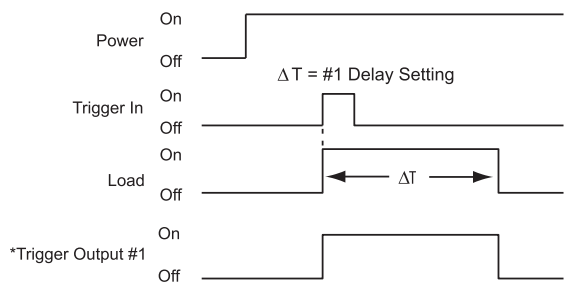

When power is applied, load remains Off. Load is energized for  $\Delta T$  only upon closure of a normally open momentary contact switch (trigger). Reset occurs when load is Off and the trigger switch is closed.

Refer to charts 1 and 3 on page 60 for switch settings.

\*Trigger Output #2 level is always opposite of Trigger Output #1.

Delay On Make (Normally On)

Function #8

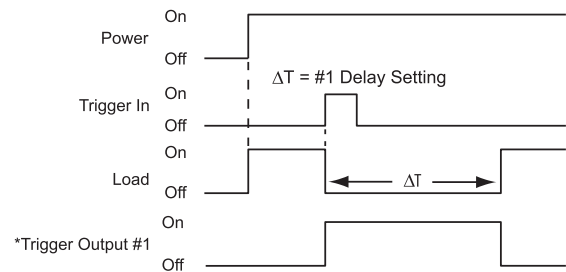

When power is applied, load is energized. Load de-energizes for  $\Delta T$  only upon closure of a normally open momentary contact switch (trigger). Reset occurs when load is On and the trigger switch is closed.

Refer to charts 1 and 3 on page 60 for switch settings.

\*Trigger Output #2 level is always opposite of Trigger Output #1.

Toggle

Function #9a / 9b

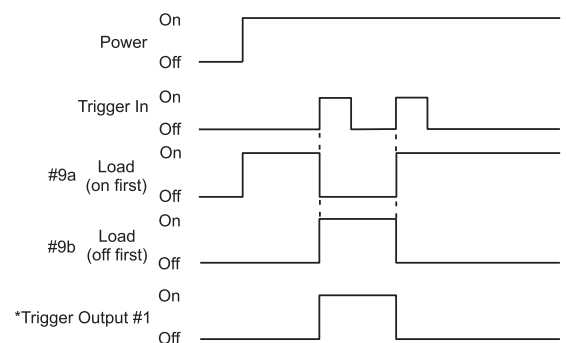

When power is applied, load is On. Load switches state (On/Off) with each application of trigger

Refer to chart 3 on page 60 for switch settings.

\*Trigger Output #2 level is always opposite of Trigger Output #1.

M  
B  
T

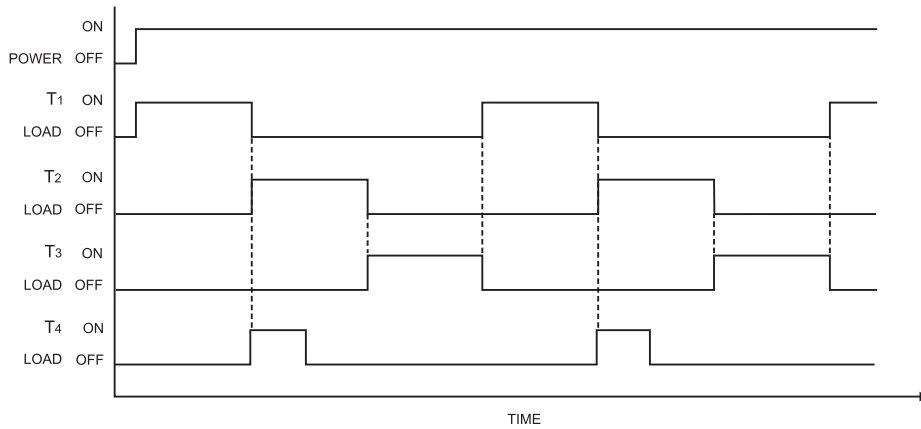
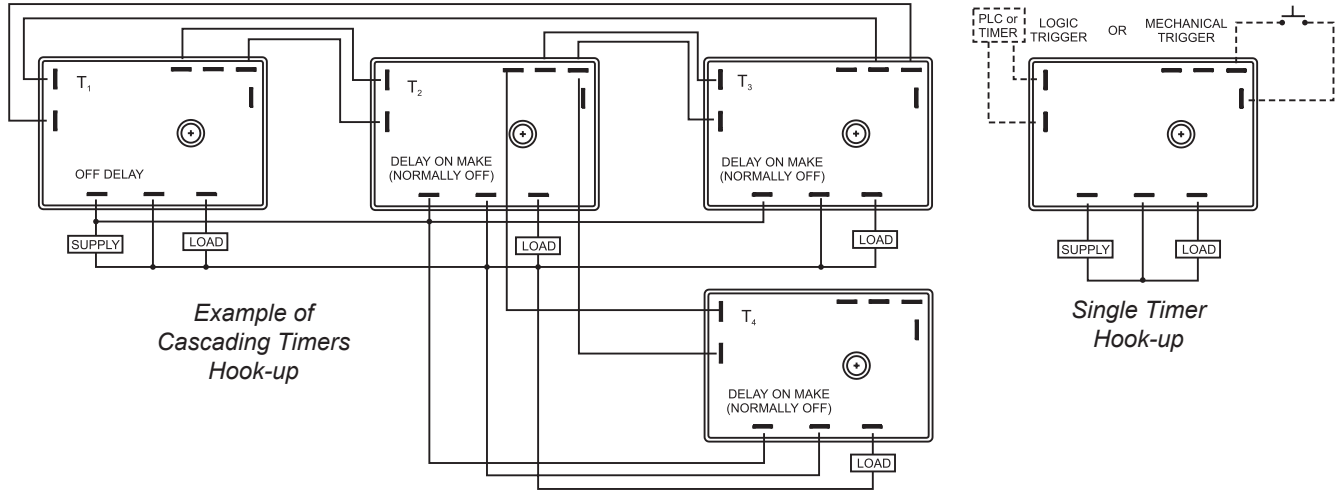

MBT



Consult factory for available versions listed by Canadian Standards Association for use with certified electrical equipment.

Ordering Information

Model # MBT-1000-00

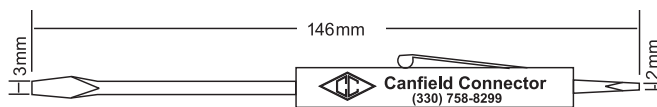

Optional Adjustment Tool  
part # 5000-TOOL

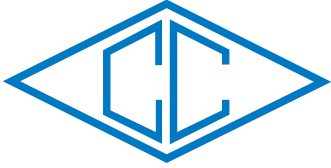

## canfield connector

8510 Foxwood Court  
Youngstown, Ohio 44514  
(330) 758-8299 Fax: (330) 758-8912  
www.canfieldconnector.com

### SERIES 7000

### REED AND ELECTRONIC SENSORS FOR 2" TO 8" BORE TIE ROD CYLINDERS

#### General Description

The Canfield Series 7000 proximity sensors are used to sense position on cylinders from 2 to 8 inch bore. This proven design is rugged yet cost effective. All switches feature a self adjusting clamp that grips standard NFPA and custom cylinders eliminating stocking requirements of many clamps for different bore sizes. The Series 7000 boasts the largest number of custom circuits to match applications found in the market. Examples include; 1 or 4 Amp reed switches, normally open, normally closed or SPDT switch types, reed or electronic sensing elements in the same package style, and the industry's first 120 VAC Hall sensor. A wide range of enclosures and connector options are available.

#### Dimensional Data

ALL DIMENSIONS ARE IN MILLIMETERS UNLESS OTHERWISE NOTED

12mm Quick Connect  
Style 5

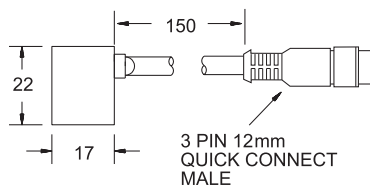

Standard Cable Module (9 ft)  
Style 0

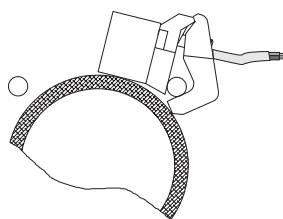
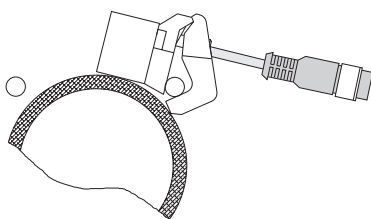
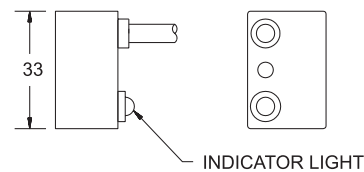
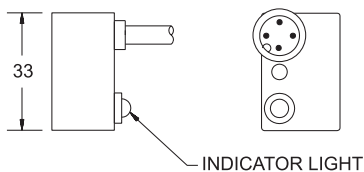
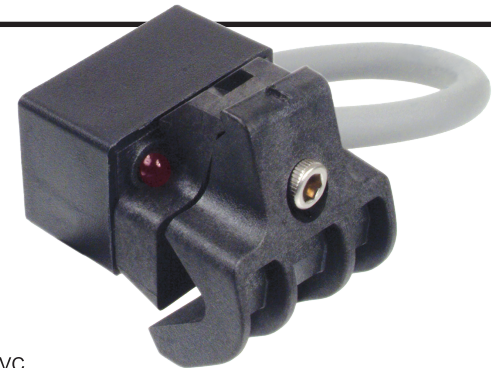
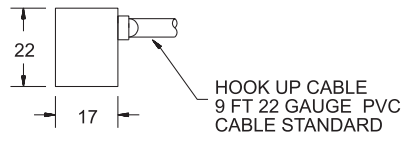

Consult factory for available versions listed by Canadian Standards Association for use with certified electrical equipment.

#### Technical Data

#### Features

- Temperature Range: Operational from -20° to +80°C.
- Shock: Operational up to 30G (11 ms.) reeds only. Not applicable for electronics.
- Vibration: Operational up to 20 G (10 - 55Hz) reeds only. Not applicable for electronics.
- Sensitivity and orientation: 85 gauss parallel minimum required for proper operation, as measured on sensor surface. Size of sensing area depends on size and strength of magnet and thickness of cylinder wall.
- One switch for a majority of voltages and cylinder sizes
- 2" - 6" bore, same clamp (8" bore optional)
- Wash down compatible NEMA 6 (most versions)
- Materials: Ultem®, Nylon, PVC wire and stainless steel
- CSA approved versions
- "Floating" clamp
- Surge suppression
- Compatible with IS (Intrinsically Safe) barriers



## Ordering Information

7 1 0 -  0 0 -

### Clamp Style

0 - Universal tie rod clamp (for cylinders 2" to 6" bore)  
9 - 5/8" tie rod 6" to 8" bore cylinder clamp

### Connector Style

0 - Standard cable module (9 ft)  
5 - 12mm quick connect male\*

\*Mates with cordset RC12S-F0M030120 (2m)  
or RC12S-F0M030150 (5m) shown at right.

12mm female molded locking connector (3 pole)

250VAC/DC 4 Amps max.

ALL DIMENSIONS ARE IN MILLIMETERS UNLESS OTHERWISE NOTED

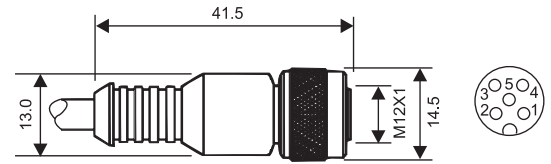

Brown = Pin 1  
Blue = Pin 3  
Black = Pin 4  
N/C = Pin 2  
N/C = Pin 5

Order part number

RC12S-F0M030120 (2m length)  
RC12S-F0M030150 (5m length)

Type	Description	Function	Switching Voltage	Switching Current	Switching Power	Switching Speed	Voltage Drop
01	Reed Switch, 2 Wire	Normally Open SPST	0 - 240V AC/DC 50/60 Hz	1 Amp max.	30 watts max.	0.6 ms operate 0.05 ms release	0 Volts
04	Reed Switch, MOV, LED, 2 Wire	Normally Open SPST	5 - 240V AC/DC 50/60 Hz	1 Amp max. .005 Amps min.	30 watts max.	0.6 ms operate 0.05 ms release	3 Volts
05	Reed Switch, 2 Wire	Normally Closed SPST	0 - 120V AC/DC 50/60 Hz	1 Amp max.	20 watts max.	1.0 ms operate 0.02 ms release	0 Volts
06	Reed Switch, LED, 3 Wire	Single Pole, Double Throw	5 - 120V AC/DC 50/60 Hz	1 Amp max. .005 Amps min.	20 watts max.	1.0 ms operate 0.02 ms release	3Volts/load1 0Volts/load2
09	Reed Switch, MOV, LED, 2 Wire	Normally Closed SPST	5 - 120V AC/DC 50/60 Hz	1 Amp max. .005 Amps min.	20 watts max.	1.0 ms operate 0.02 ms release	3 Volts
15	AC Electronic Sensor for Reed Magnets, LED, 3 Wire	Normally Open TRIAC output	12-24 VAC	600 mA max. 5 Amps Inrush	15 watts max.	1.5 $\mu$ s operate 0.5 $\mu$ s release	1 Volt
16	AC Electronic Sensor for Reed Magnets, LED, 3 Wire	Normally Open TRIAC output	120 VAC	4 Amps max. 50 Amps Inrush	100 watts max.	0.6 $\mu$ s operate 0.05 $\mu$ s release	1 Volt
21	Reed Switch, MOV, 2 Wire	Normally Open TRIAC output	10 - 240 VAC 50/60 Hz	4 Amps max. 50 Amps Inrush	100 watts max.	0.6 ms operate 0.05 ms release	1 Volt
23	Reed Switch, MOV, LED, 3 Wire	Normally Open TRIAC output	10 - 50 VAC 50/60 Hz	4 Amps max. 50 Amps Inrush .005 Amps min.	100 watts max	0.6 ms operate 0.05 ms release	1 Volt
24	Reed Switch, MOV, LED, 3 Wire	Normally Open TRIAC output	24 - 240 VAC 50/60 Hz	4 Amps max. 50 Amps Inrush .005 Amps min.	100 watts max	0.6 ms operate 0.05 ms release	1 Volt
25	Reed Switch, MOV, 2 Wire	Normally Closed TRIAC output	10-120 VAC 50/60 Hz	4 Amps max. 50 Amps Inrush	100 watts max	0.6 ms operate 0.05 ms release	1 Volt
29	Reed Switch, MOV, LED, 3 Wire	Normally Closed TRIAC Output	10-120 VAC 50/60 Hz	4 Amps Max. 50 Amps Inrush .005 Amps Min.	100 Watts Max.	06 ms operate 0.05 ms release	1 Volts
31	Electronic for Reed Magnet, LED & Sourcing, 3 Wire	Normally Open PNP	6 - 24 VDC	1 Amp Max.	24 Watts Max.	1.5 $\mu$ s operate 0.5 $\mu$ s release	0.5 Volts
32	Electronic for Reed Magnet, LED & Sinking, 3 Wire	Normally Open NPN	6 - 24 VDC	1 Amp Max.	24 Watts Max.	1.5 $\mu$ s operate 0.5 $\mu$ s release	0.5 Volts

7000

Each switch supplied with clamp assembly

For convenience and faster shipping, this series is available in Can-Paks.



### Ordering Example:

710-000-004

Universal tie rod clamp, Standard cable, reed switch, lighted, MOV surge suppression, normally open, 5 - 240V AC/DC 50/60 Hz

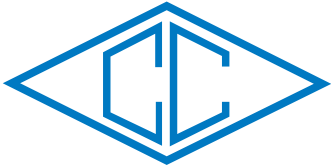

**canfield connector**  
 8510 Foxwood Court  
 Youngstown, Ohio 44514  
 (330) 758-8299 Fax: (330) 758-8912  
 www.canfieldconnector.com

## SERIES 7HL

## HAZARDOUS LOCATION MAGNETIC PROXIMITY SENSORS FOR TIE ROD CYLINDERS

### General Description

The Canfield Connector 7HL is a rugged magnetic proximity sensor designed to sense actuator position in stringent, hazardous location applications. The switch features a robust, epoxy-filled, aircraft aluminum body, and has a vibration and shock resistant, electronic circuit. The 7HL is an expansion of the popular Series 7000 "floating" clamp design and will clamp on 2 to 8 inch bore NFPA tie rod linear actuators. This product is designed to operate in hazardous locations, this switch is CSA approved for Class I, Division 2, Groups A, B, C, and D; Class II, Division 2, Groups F and G; and Class III.

### Dimensional Data

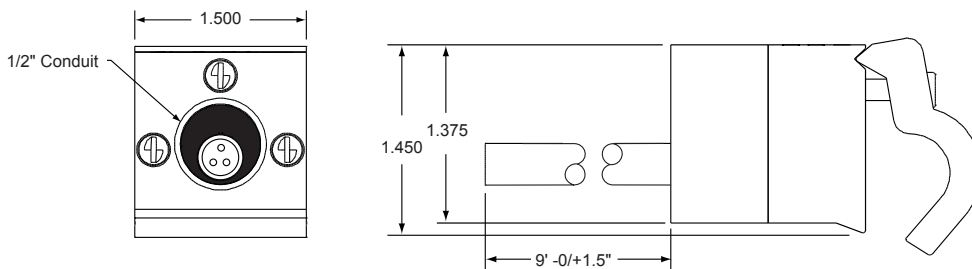

### Electrical, Mounting Installation

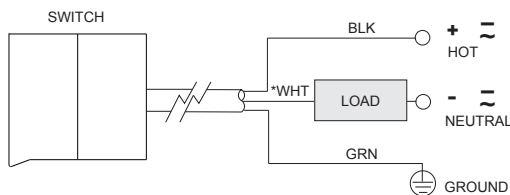

⎓ Both direct and alternating current

⊕ Earth (ground) TERMINAL

\*White wire must be permanently reidentified to indicate its use as an ungrounded conductor, by painting or other effective means at its termination, and each location where the conductor is visible and accessible. Per NEC Article (200.7)

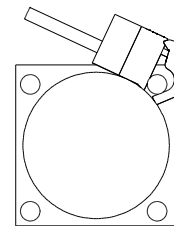

MOUNTING



Consult factory for available versions listed by Canadian Standards Association for use with certified electrical equipment.

### Technical Data

- Temperature Range: Operational from -20° to +80°C
- Shock: Operational up to 30 G (11ms)
- Vibration: Operational up to 20 G (10 - 55 Hz)
- Sensitivity: 85 Gauss parallel minimum, as measured on the surface of actuator
- Pollution Degree: 3
- Environmental protection: NEMA 1, 4 and 13
- Hazardous location ratings:
  - CSA: Class I, Division 2, Groups A, B, C and D; Class II, Division 2, Groups F and G; and Class III
- Body Material: Anodized 6061-T6 Aluminum, Epoxy encapsulated printed circuit board
- Wire: SJE00W 18/3 Leads
- Circuit: S.P.S.T., Normally Open
- Operating Voltage: 0 - 120 V AC/DC 50/60 Hz
- Maximum Load (Power Rating): 10W, Resistive Only
- Maximum Current: 0.5A Max.
- Response Time ON: 0.5ms
- Response Time OFF: 0.1ms

### Features

- Meets hazardous location specifications
- Metal body with robust 1/2" conduit
- Fully encapsulated electronics
- Cam-lock clamp ensures proper assembly and sensor position
- Compatible for wash down and corrosive environments
- Compatible with anodized 6061 Aluminum material

### Ordering Information

Order # 7HL10-000-001

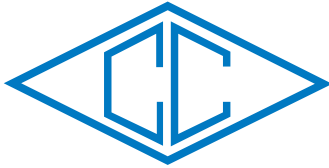

**canfield connector**  
 8510 Foxwood Court  
 Youngstown, Ohio 44514  
 (330) 758-8299 Fax: (330) 758-8912  
 www.canfieldconnector.com

## SERIES 7GL

## GENERAL LOCATION MAGNETIC PROXIMITY SENSORS FOR TIE ROD CYLINDERS

### General Description

The Canfield Connector 7GL is an expansion of the popular Series 7000 “floating” clamp design, which adapts to NFPA tie rod linear actuators with 2 to 8 inch bore. This rugged magnetic proximity sensor can sense actuator position in stringent, general location applications. The switch features a robust, aircraft aluminum body, epoxy-filled, vibration and shock resistant, electronic circuit. Available in a normally open contact, the 7GL can switch current up to .5 Amps and has a voltage range of 0-120VAC/VDC 50/60 Hz.

### Dimensional Data

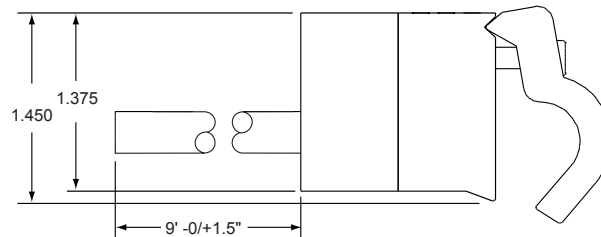
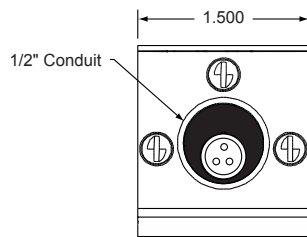

### Electrical, Mounting Installation

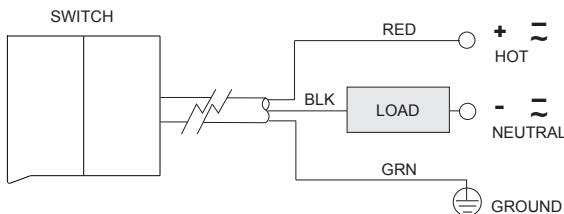

⎓ Both direct and alternating current

⊕ Earth (ground) TERMINAL

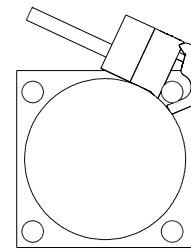

MOUNTING

### Technical Data

- Temperature Range: Operational from -20° to +80°C
- Shock: Operational up to 30 G (11ms)
- Vibration: Operational up to 20 G (10 - 55 Hz)
- Sensitivity: 85 Gauss parallel minimum, as measured on the surface of actuator
- Environmental protection: NEMA 1, 4 and 13
- Body Material: Anodized 6061-T6 Aluminum, Epoxy encapsulated printed circuit board
- Wire: PVC 20/3 Leads
- Circuit: S.P.S.T., Normally Open
- Operating Voltage: 0 - 120 V AC/DC 50/60 Hz
- Maximum Load (Power Rating): 10W, Resistive Only
- Maximum Current: 0.5A Max.
- Response Time ON: 0.5ms
- Response Time OFF: 0.1ms

### Features

- Normally open reed switch for general location
- Metal body with robust 1/2" conduit
- Fully encapsulated electronics
- Cam-lock clamp ensures proper assembly and sensor position
- Compatible for wash down
- Compatible with anodized 6061 Aluminum material

### Ordering Information

Order # 7GL10-000-001

7GL

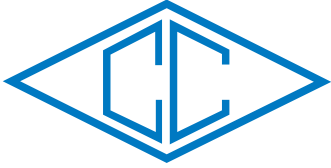

**canfield connector**  
8510 Foxwood Court  
Youngstown, Ohio 44514  
(330) 758-8299 Fax: (330) 758-8912  
www.canfieldconnector.com

## SERIES 8000

## REED & ELECTRONIC SENSORS FOR ROUND, TIE-ROD, OR EXTRUDED CYLINDERS

### General Description

The Canfield Connector Series 8000 Reed and Electronic sensors are compact units designed for sensing applications on round cylinders from 9/16" - 4" and tie-rod pneumatic cylinders from 3/4" - 8" bore. These sensors offer a wide voltage range from 0-120 VAC/VDC 50/60 Hz and high current capacity up to 0.5 Amps. They include high intensity indicator lights and a wide viewing angle. The sensor's small package can fit easily on the smallest cylinder without appearing too large. The Series 8000's design promotes ease of installation with a tight fit. Options include 9ft. PVC or 8mm quick connect male pigtail.

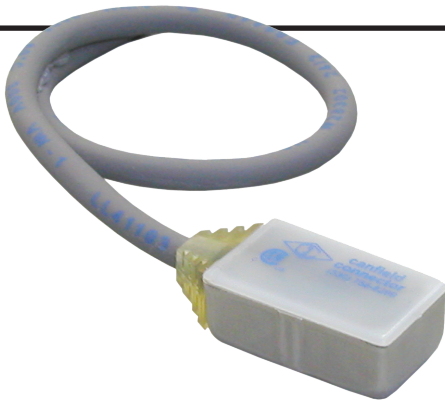

### Features

- Extremely consistent repeatability
- Compact design
- Surge suppression available (standard on electronic)
- Reverse polarity protection
- Wide voltage range
- Compatible with IS (Intrinsically Safe) barriers
- High intensity light (LED) standard on most models
- Compatible with most corrosive and washdown applications
- High current capacity for small size (up to 10 times the competition)
- Both reed and electronic versions work with the same (reed) magnet
- Encapsulated circuit for wet environment

### Technical Data

- Temperature Range: Operational from -20° to +80°C
- Shock: Operational up to 30G (11 ms.) reeds only. Not applicable for electronic
- Vibration: Operational up to 20G (10 - 55 Hz) reeds only. Not applicable for electronic
- Sensitivity and orientation: 85 gauss parallel (standard minimum required for proper operation, as measured on sensor surface. Size of sensing area depends on size and strength of magnet and thickness of cylinder wall)
- Most versions designed to meet NEMA 6/IP67 specifications
- Note: Not compatible with alcohol based fluids. Contact factory for suitable replacement



Consult factory for available versions listed by Canadian Standards Association for use with certified electrical equipment.

## Dimensional Data

ALL DIMENSIONS ARE IN MILLIMETERS UNLESS OTHERWISE NOTED

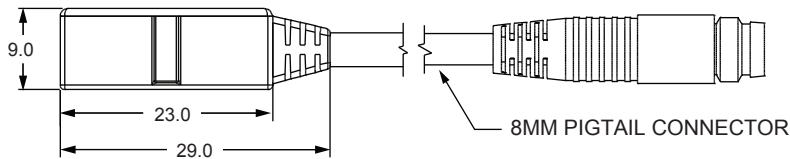
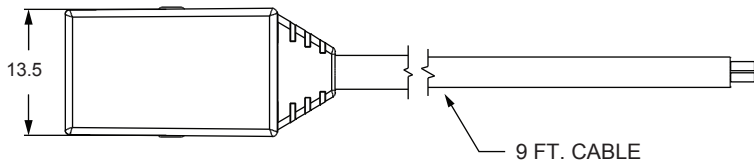

## Clamp Styles

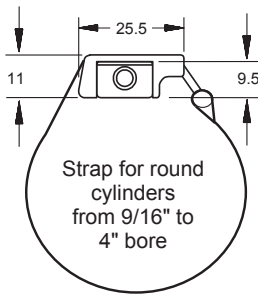

**Standard Round Cylinder Universal Clamp (Style 0)**

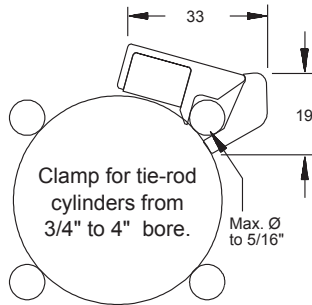

**Standard Tie-Rod Cylinder Clamp (Style 2)**

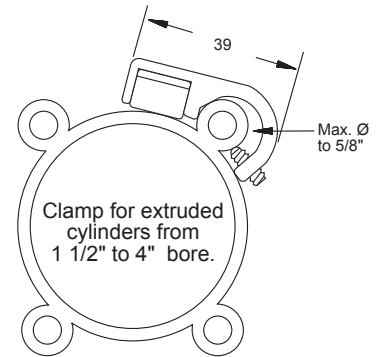

**Extruded Cylinder Clamp (Style 3)**

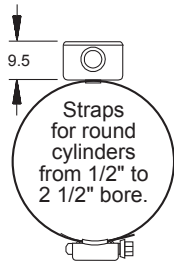

**Low-Profile Round Cylinder Clamp (Style 5-9)**

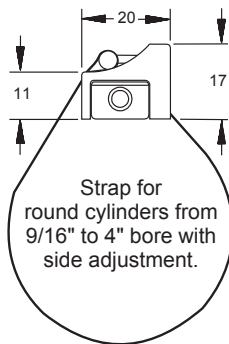

**Side Adjust Round Cylinder Clamp (Style A)**

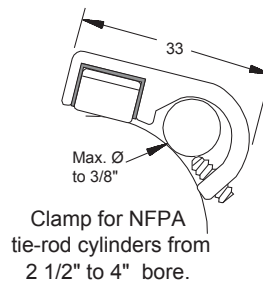

**NFPA Tie-Rod Cylinder Clamp (Style B)**

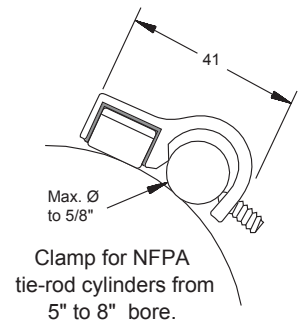

**NFPA Tie-Rod Cylinder Clamp (Style C)**

## Ordering Information

8 1 0 -  0 0 -

### Clamp Styles

- 0 - Universal round cylinder clamp
- 1 - No clamp
- 2 - Universal tie-rod clamp
- 3 - Extruded cylinder clamp
- 5 - Clamp loop / no clamp\*\*\*
- 6 - Clamp loop / 1/2" - 3/4" clamp
- 7 - Clamp loop / 1" - 1 1/2" clamp
- 8 - Clamp loop / 1 1/2" - 2" clamp
- 9 - Clamp loop / 2" - 2 1/2" clamp
- A - Side adjust round cylinder clamp
- B - NFPA 2 1/2" - 4" tie-rod cylinder clamp
- C - NFPA 5" - 8" tie-rod cylinder clamp

\*\*\*Uses 5/16" wide band clamp

### Connection Options

- 0 - 9 ft PVC cable
- 1 - 8mm quick connect male pigtail\*

\*Mates with cordsets shown at right.

### Mating Cordsets

8mm female molded locking connectors

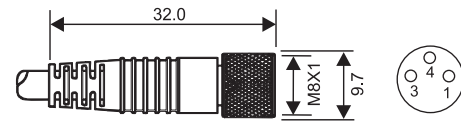

(for sensor types 01, 02, 04, 31, 32)

### Order part number

- Brown = Pin 1
- Blue = Pin 3
- Black = Pin 4

- RC08S-F0M030120 (2m length)
- RC08S-F0M030150 (5m length)

Type	Description	Function	Switching Voltage	Switching Current	Switching Power	Voltage Drop	Magnetic Sensitivity
01	Reed Switch	Normally Open	0 - 120V AC/DC	0.5 Amps Max.	10 watts Max.	0 Volts	85 Ga.
02	Reed Switch & LED	SPST Normally Open	5 - 120V AC/DC	0.025 Amps Max. 0.001 Amps Min.	3 watts Max.	6.0 Volts	85 Ga.
04	Reed Switch, LED & MOV	SPST Normally Open	5 - 120V AC/DC	0.5 Amps Max. 0.005 Amps Min.	10 watts Max.	3.0 Volts	85 Ga.
31	Electronic for Reed Magnet, LED & Sourcing	Normally Open (PNP)	6 - 24 VDC	0.3 Amps Max.	7.2 watts Max.	.5 Volts	85 Ga.
32	Electronic for Reed Magnet, LED & Sinking	Normally Open (NPN)	6 - 24 VDC	0.3 Amps Max.	7.2 watts Max.	.5 Volts	85 Ga.



### SERIES 8000

Can-Pak Part Number	Qty	Function Normally Open	Switch Type
CP-810-000-002-010	10	SPST	Reed
CP-810-200-002-010	10	PNP	Reed
CP-810-000-102-010	10	NPN	Reed
CP-810-200-102-010	10	SPST	Reed

### Ordering Example:

810-000-002

Universal round cylinder clamp, 9ft PVC cable, reed switch with LED, SPST, normally open, 5 - 120V AC/DC

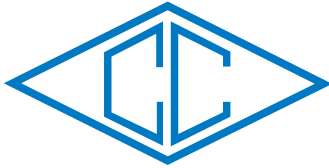

**canfield connector**  
8510 Foxwood Court  
Youngstown, Ohio 44514  
(330) 758-8299 Fax: (330) 758-8912  
www.canfieldconnector.com

## SERIES 8D

## REED & ELECTRONIC SENSORS FOR ROUND, TIE-ROD, OR EXTRUDED CYLINDERS

### General Description

The Canfield Connector Series 8D is a robust yet compact switch designed to sense position of pneumatic cylinders with magnetic pistons. The switch features an all encapsulated design with a metal over housing that protects the internal components from harsh environments. The switch comes in reed, or electronic versions and has either 9 ft. PVC or 8mm quick connect male pigtail. A broad range of clamping styles make this a very versatile alternative for sensing round or tie rod type linear actuator. The switch comes standard with an indicator light that shows switching condition.

### Dimensional Data

ALL DIMENSIONS ARE IN MILLIMETERS UNLESS OTHERWISE NOTED

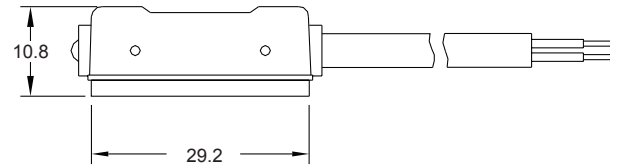
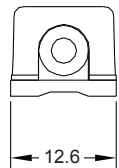

### Clamp Styles

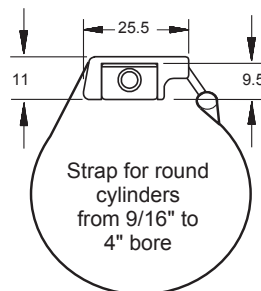

**Standard  
Round Cylinder  
Universal Clamp  
(Style 0)**

Strap for round  
cylinders  
from 9/16" to  
4" bore

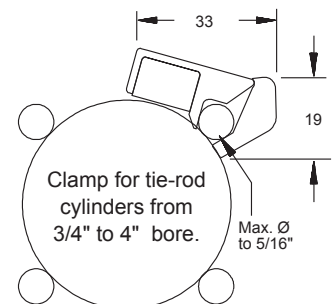

**Standard  
Tie-Rod  
Cylinder Clamp  
(Style 2)**

Clamp for tie-rod  
cylinders from  
3/4" to 4" bore.  
Max. Ø  
to 5/16"

### Features

- Quick connect versions available
- Extremely consistent repeatability
- Compact design
- Reverse polarity protection
- Both reed and electronic versions work with the same (reed) magnet
- Encapsulated circuit for wet environment (NEMA 6)
- Available for tie-rod, round or extruded cylinder mounting

**Technical Data**

- Temperature Range: Operational from -10° to +70°C
- Shock: Operational up to 30G (11 ms.) reeds, 50G electronic
- Vibration: Operational up to 9G parallel
- Sensitivity and orientation: 60G parallel (standard minimum required for proper operation, as measured on sensor surface. Size of sensing area depends on size and strength of magnet and thickness of cylinder wall)
- Most versions designed to meet NEMA 6/IP67 specifications

**Ordering Information**

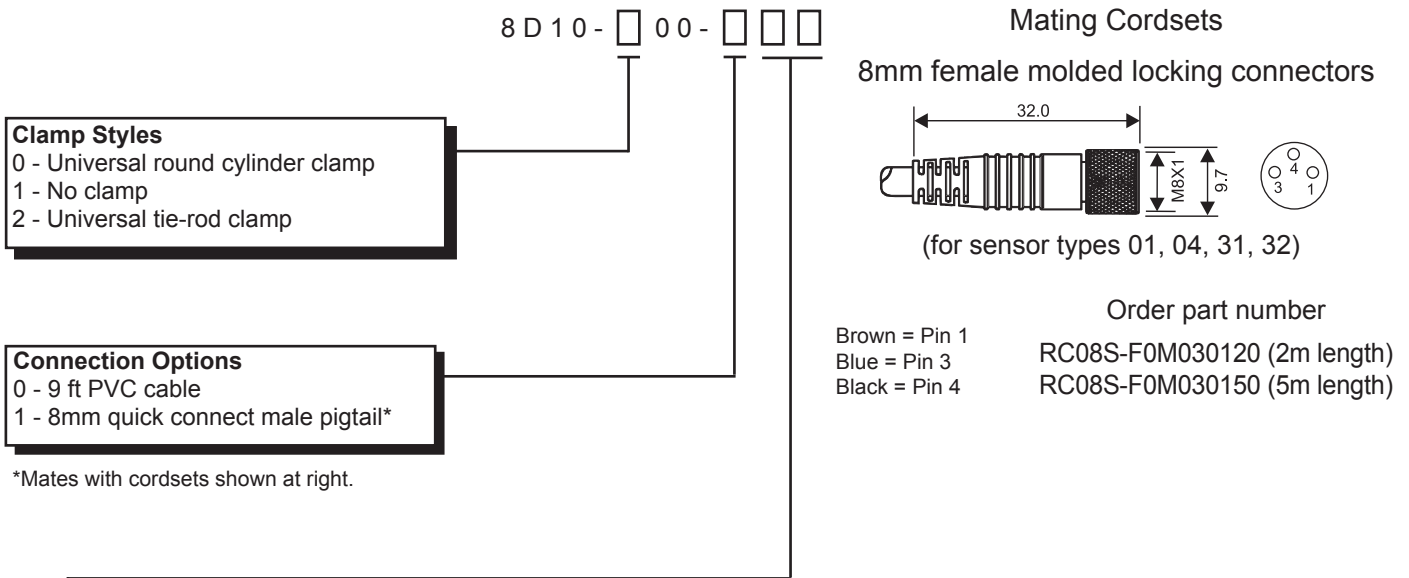

Type	Description	Function	Switching Voltage	Switching Current	Switching Power	Voltage Drop	** Magnetic Sensitivity
01	Reed Switch	Normally Open	0 - 240V AC/DC	0.5 Amps Max.	10 watts Max.	0 Volts	60 Ga.
04	Reed Switch, LED & MOV	SPST Normally Open	5 - 240V AC/DC	100 mA	10 watts Max.	2.5 Volts	60 Ga.
31	Electronic for Reed Magnet, LED & Sourcing	Normally Open (PNP)	5 - 28 VDC	.2 Amps Max.	6 watts Max.	1.5 Volts	60 Ga.
32	Electronic for Reed Magnet, LED & Sinking	Normally Open (NPN)	5 - 28 VDC	.2 Amps Max.	6 watts Max.	1.5 Volts	60 Ga.

\*\*Minimum gauss rating required for proper operation; as measured 4.5 above sensing surface. Size of sensing area depends upon size and strength of magnet and thickness of cylinder wall.

**Ordering Example:**

8D10-000-004

Universal round cylinder clamp, 9 ft. cable, standard style reed switch with LED & MOV, SPST, normally open, 5 - 240V AC/DC



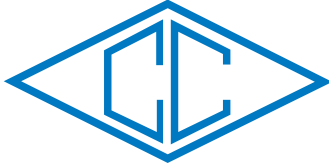

**canfield connector**  
8510 Foxwood Court  
Youngstown, Ohio 44514  
(330) 758-8299 Fax: (330) 758-8912  
www.canfieldconnector.com

## SERIES 8E

## REED & ELECTRONIC SENSORS FOR ROUND, TIE-ROD, OR EXTRUDED CYLINDERS

### General Description

The Canfield Connector Series 8E is a linear actuator magnetic sensor designed for harsh industrial applications. With mounting styles for tie rod or round type linear actuators, the 8E features an all encapsulated body that is covered by a metal housing for strength. The switch is available in reed or electronic versions and electrical connection is made by use of 9 ft. PVC or 8mm quick connect male pigtail. The 8E is water resistant and dust tight to IP-67.



### Dimensional Data

ALL DIMENSIONS ARE IN MILLIMETERS UNLESS OTHERWISE NOTED

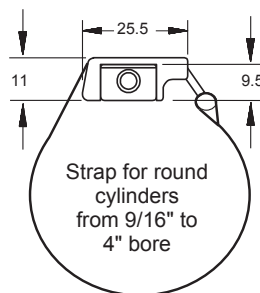
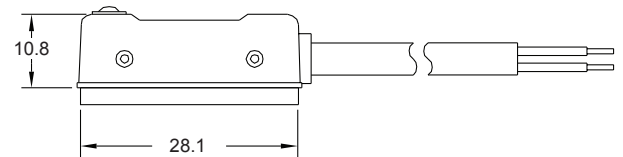
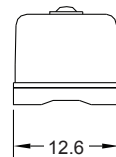

### Clamp Styles

Strap for round cylinders from 9/16" to 4" bore

**Standard Round Cylinder Universal Clamp (Style 0)**

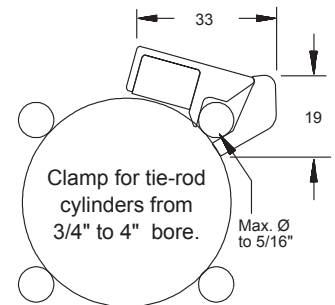

Clamp for tie-rod cylinders from 3/4" to 4" bore.

**Standard Tie-Rod Cylinder Clamp (Style 2)**

### Features

- Quick connect versions available
- Extremely consistent repeatability
- Compact design
- Reverse polarity protection
- Both reed and electronic versions work with the same (reed) magnet
- Encapsulated circuit for wet environment (NEMA 6)
- Available for tie-rod, round or extruded cylinder mounting

8  
E

## Technical Data

- Temperature Range: Operational from -10° to +70°C
- Shock: Operational up to 30G (11 ms.) reeds, 50G electronic
- Vibration: Operational up to 9G parallel
- Sensitivity and orientation: 60G parallel (standard minimum required for proper operation, as measured on sensor surface. Size of sensing area depends on size and strength of magnet and thickness of cylinder wall)
- Most versions designed to meet NEMA 6/IP67 specifications

## Ordering Information

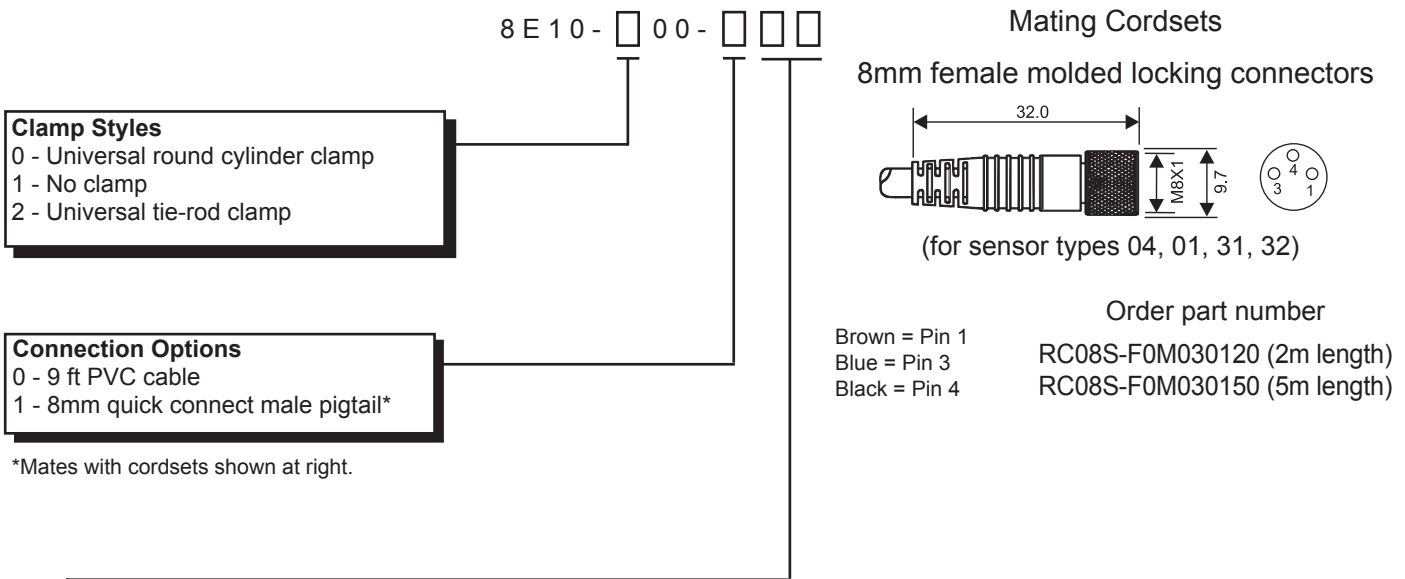

Type	Description	Function	Switching Voltage	Switching Current	Switching Power	Voltage Drop	** Magnetic Sensitivity
01	Reed Switch	Normally Open	0 - 240V AC/DC	0.5 Amps Max.	10 watts Max.	0 Volts	60 Ga.
04	Reed Switch, LED & MOV	SPST Normally Open	5 - 240V AC/DC	100 mA	10 watts Max.	2.5 Volts	60 Ga.
31	Electronic for Reed Magnet, LED & Sourcing	Normally Open (PNP)	5 - 28 VDC	0.2 Amps Max.	6 watts Max.	1.5 Volts	60 Ga.
32	Electronic for Reed Magnet, LED & Sinking	Normally Open (NPN)	5 - 28 VDC	0.2 Amps Max.	6 watts Max.	1.5 Volts	60 Ga.

\*\*Minimum gauss rating required for proper operation; as measured 4.5 above sensing surface. Size of sensing area depends upon size and strength of magnet and thickness of cylinder wall.

### Ordering Example:

8E10-000-004

Universal round cylinder clamp, 9 ft. cable, standard style reed switch with LED & MOV, SPST, normally open, 5 - 240V AC/DC

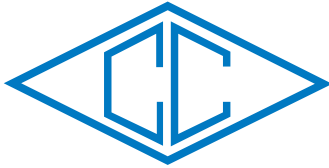

**canfield connector**  
8510 Foxwood Court  
Youngstown, Ohio 44514  
(330) 758-8299 Fax: (330) 758-8912  
www.canfieldconnector.com

## SERIES 8WS (WORLDSWITCH)

## REED & ELECTRONIC SENSORS FOR PNEUMATIC CYLINDERS WITH 12MM DOVETAILED

### General Description

The Canfield Connector Series 8WS reed and electronic magnet sensors are rugged yet compact switches used to sense position on pneumatic actuators equipped with a magnetic piston and 12mm dovetail groove. The switch can be slipped in and tightened from anywhere along the groove that is fabricated into the cylinder wall or clamping system. The switch features a die cast holder which clamps to the cylinder groove while the electronics are fully encapsulated and resistance to environment. These sensors offer a wide voltage range from 0-120 V AC/DC 50/60Hz and have a up to a 500 mA switching current rating. The switch has a high intensity indicator light which indicates power to the switch and load. The switch comes standard with 9 ft. PVC or 8mm quick connect male pigtail.

### Dimensional Data

ALL DIMENSIONS ARE IN MILLIMETERS UNLESS OTHERWISE NOTED

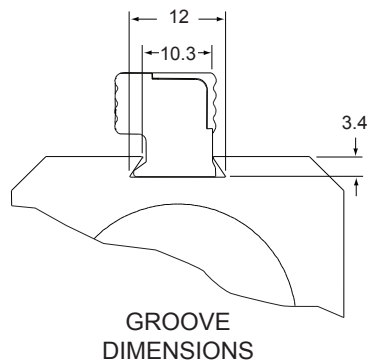
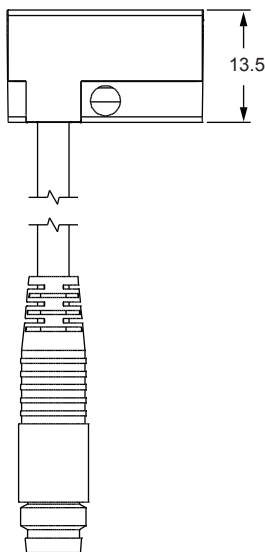
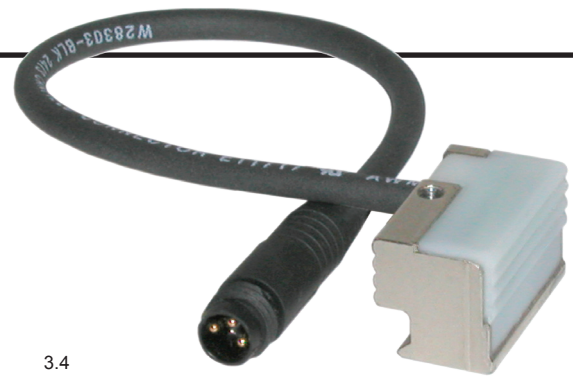

GROOVE DIMENSIONS

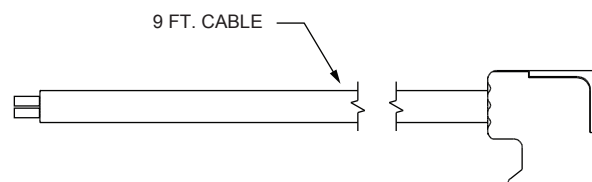
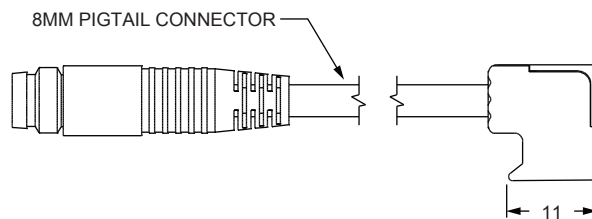
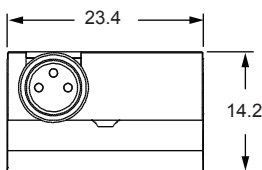

8  
W  
S

## Technical Data

- Temperature Range: Operational from -20° to +80°C
- Shock: Operational up to 30G (11 ms.) reeds only. Not applicable for electronic.
- Vibration: Operational up to 20G (10 - 55 Hz) reeds only. Not applicable for electronic.
- Sensitivity and orientation: 85 gauss parallel (standard minimum required for proper operation, as measured on sensor surface. Size of sensing area depends on size and strength of magnet and thickness of cylinder wall.
- Most versions designed to meet NEMA 6/IP67 specifications

## Features

- Robust design
- Metal housing
- Simple installation
- Reverse polarity
- Quick connect designs available
- Wide voltage range
- High current capacity
- Over voltage protection
- Indicator light can be seen from all angles



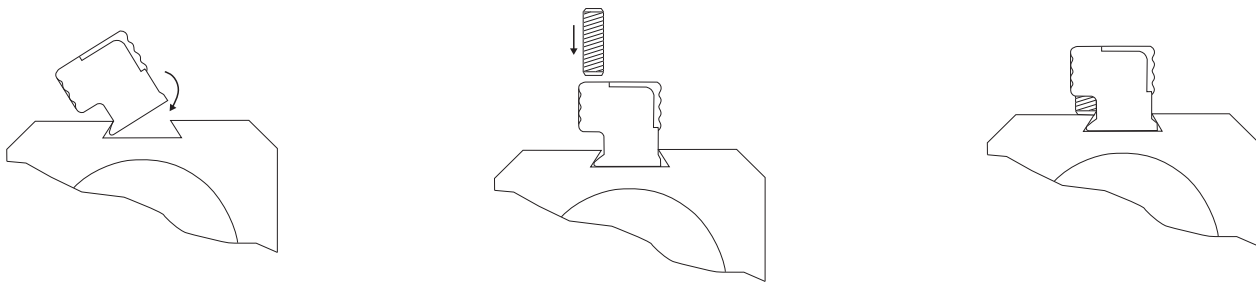

Consult factory for available versions listed by Canadian Standards Association for use with certified electrical equipment.

## Installation



## Ordering Information

8 W S 1 0 - 0 0 0 -   

Mating Cordsets  
8mm female molded locking connectors

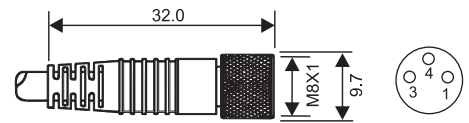

(for sensor types 01, 02, 04, 31, 32)

Brown = Pin 1  
Blue = Pin 3  
Black = Pin 4

Order part number  
RC08S-F0M030120 (2m length)  
RC08S-F0M030150 (5m length)

**Connection Options**  
0 - 9 ft PVC cable  
1 - 8mm quick connect male pigtail\*

\*Mates with cordset shown at right.

Type	Description	Function	Switching Voltage	Switching Current	Switching Power	Voltage Drop	** Magnetic Sensitivity
01	Reed Switch	Normally Open	0 - 120V AC/DC	0.5 Amps Max.	10 watts Max.	0 Volts	85 Ga.
02	Reed Switch & LED	SPST Normally Open	5 - 120V AC/DC	0.025 Amps Max. 0.001 Amps Min.	3 watts Max.	6.0 Volts	85 Ga.
04	Reed Switch, LED & MOV	SPST Normally Open	5 - 120V AC/DC	0.5 Amps Max. 0.005 Amps Min.	10 watts Max.	3.0 Volts	85 Ga.
31	Electronic for Reed Magnet, LED & Sourcing	Normally Open (PNP)	6 - 24 VDC	0.3 Amps Max.	7.2 watts Max.	.5 Volts	85 Ga.
32	Electronic for Reed Magnet, LED & Sinking	Normally Open (NPN)	6 - 24 VDC	0.3 Amps Max.	7.2 watts Max.	.5 Volts	85 Ga.

\*\*Minimum gauss rating required for proper operation; as measured 4.5 above sensing surface. Size of sensing area depends upon size and strength of magnet and thickness of cylinder wall.

## Ordering Example:

8WS10-000-002

9 ft. PVC cable, reed switch for PLC with LED, SPST normally open, 5 - 120V AC/DC

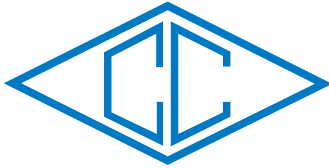

**canfield connector**  
 8510 Foxwood Court  
 Youngstown, Ohio 44514  
 (330) 758-8299 Fax: (330) 758-8912  
 www.canfieldconnector.com

**SERIES 9C**

**REED & ELECTRONIC MAGNETIC SENSORS  
 FOR ROUND KEYWAY GROOVE**

**General Description**

The Series 9C is a compact, universal, magnetically operated proximity switch commonly used on aluminum extruded profile type linear actuators equipped with magnetic pistons. The switches are available in both reed and electronic styles and made to fit into a 4mm key hole type slot. Position fixing is accomplished by means of a screw that is supplied in the switch body. The on board indicator light shows instant switch diagnostics to minimize downtime and facilitate installation and can be seen from wide angles. Available in the standard 9 ft. PVC wired or optional 8mm quick connect, the switch can handle AC or DC current in several configurations. The 9C is assembled in engineered polymers and designed to meet NEMA 6 / IP 67 environmental specifications.

**Dimensional Data**

ALL DIMENSIONS ARE IN MILLIMETERS UNLESS OTHERWISE NOTED

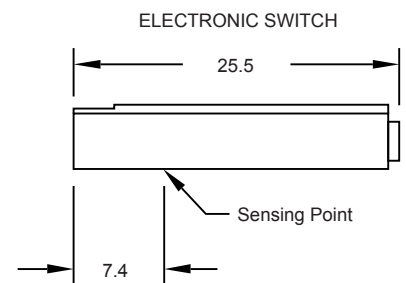
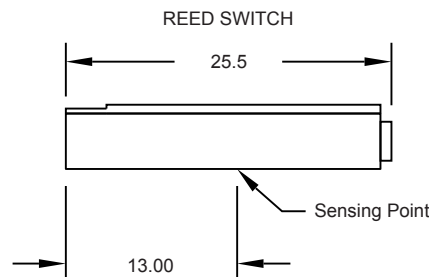
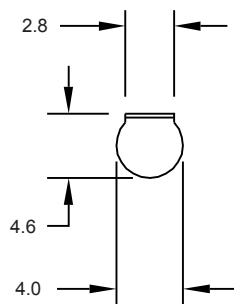

**GROOVE  
 DIMENSIONS**

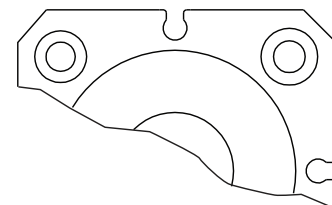
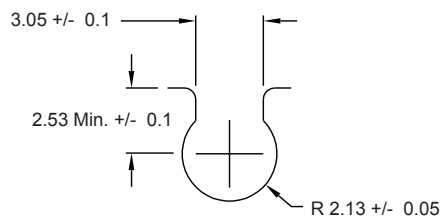

9  
C

## Features

- Ultra small sensor fits where other sensors will not
- Reverse polarity protection and surge suppression (electronic)
- Indicator light
- Corrosion and washdown resistance
- Solid state version available (no moving parts)
- Quick connect version
- 9 ft cable standard

## Technical Data

- Temperature Range: operational from -10° to +70°C
- Sensitivity and orientation: 40 gauss parallel (electronic)  
60 gauss parallel (reed)
- Meets NEMA 6 / IP65 specifications
- CE Approved

## Ordering Information

### Connection Options

- 0 - 9 ft PVC cable
- 3 - 8mm quick connect male pigtail\*

\*Mates with cordsets shown at right.

9 C 1 0 - 0 0 0 - □ □ □

### Mating Cordsets

8mm female molded locking connectors

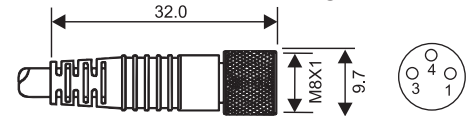

(for sensor types 02, 31, 32)

### Order part number

Brown = Pin 1  
Blue = Pin 3  
Black = Pin 4

RC08S-F0M030120 (2m length)  
RC08S-F0M030150 (5m length)

Type	Description	Function	Switching Voltage	Switching Current	Switching Power	Voltage Drop	** Magnetic Sensitivity
02	Reed Switch & LED	SPST	5 - 120V AC/DC 50/60 Hz	0.1 Amps Max.	10 watts Max.	2.5 Volts @ 40mA	60 Ga.
31	Electronic for Reed Magnet, LED & Sourcing	(PNP)	5 - 28 VDC	0.2 Amps Max.	6 watts Max.	.5 Volts @ 200mA	40 Ga.
32	Electronic for Reed Magnet, LED & Sinking	(NPN)	5 - 28 VDC	0.2 Amps Max.	6 watts Max.	.5 Volts @ 200mA	40 Ga.

\*\*Minimum gauss rating required for proper operation. Size of sensing area depends upon size and strength of magnet and thickness of cylinder wall.

### Ordering Example:

9C10-000-032

9 ft. PVC cable, electronic for reed magnet, LED, sinking, NPN, 5 - 28 VDC

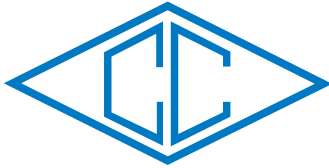

**canfield connector**  
8510 Foxwood Court  
Youngstown, Ohio 44514  
(330) 758-8299 Fax: (330) 758-8912  
www.canfieldconnector.com

## SERIES 9D

## REED & ELECTRONIC SENSORS FOR UNIVERSAL APPLICATIONS

### General Description

The Canfield Connector Series 9D is a universal, ultra-small, magnetic proximity switch available in both solid state electronic and reed styles. These sensors are designed to fit the most stringent space requirements by use of a standard .250 inch dovetail slot. Many other mounting options are also available. The electronic sensor exhibits greater sensitivity to magnetism with reduced dead-band and hysteresis as compared to competitive devices. The reed sensor offers a wide operating voltage range. The molded switch has an on board indicator light that can be viewed from wide angles. Standard connection to the sensor is provided by a 9 ft. PVC or 8mm quick connect male pigtail. The rugged 20% glass-filled polypropylene switch is shipped with mounting hardware ready for installation.

### Dimensional Data

ALL DIMENSIONS ARE IN MILLIMETERS UNLESS OTHERWISE NOTED

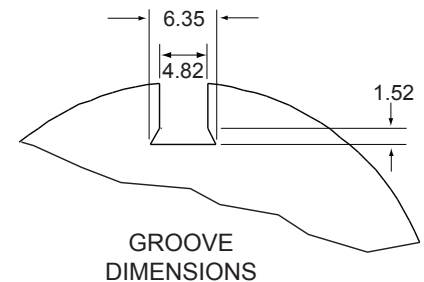
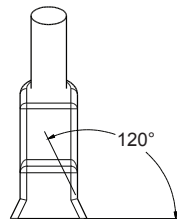
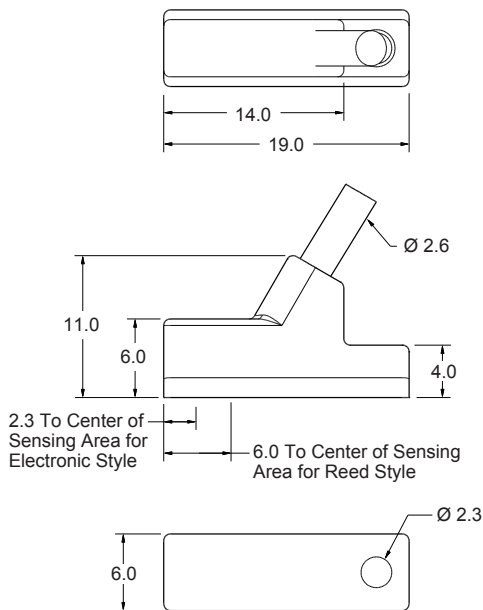

GROOVE  
DIMENSIONS

### Technical Data

- Temperature Range: Operational from -20° to +80°C
- Shock: Operational up to 30G (11 ms.) reeds only. Not applicable for electronic.
- Vibration: Operational up to 20G (10 - 55 Hz) reeds only. Not applicable for electronic.
- Most versions designed to meet NEMA 6 / IP67 specifications
- Sensitivity and Orientation: 85 gauss parallel (standard for reeds)  
25 gauss parallel (standard for electronic)

### Features

- Small sensor fits most space requirements.
- Stand-alone mounting into any 1/4" dovetail slot (machined or extruded)
- Other special mounting clamp styles available
- Indicator light
- Corrosion and washdown resistance.
- Electronic sensing version (no moving parts)
- 60° wire outlet for close mounting
- Reverse polarity protection
- DC or AC voltage versions
- Compatible with IS (Intrinsically Safe) barriers
- Molded construction for wet environment (NEMA 6)
- Available for dovetail, round, tie-rod and rodless cylinder mountings.

9  
D

**Style 0**

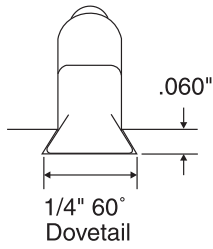

**Style 1**

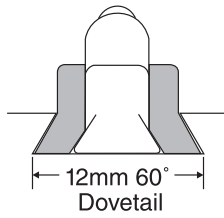

**Style 2**

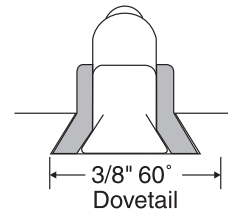

**Style 3**

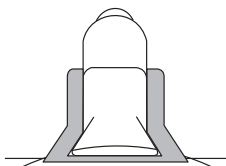

Strap for  
round cylinders  
from 3/4" to 4" bore

**Style 4**

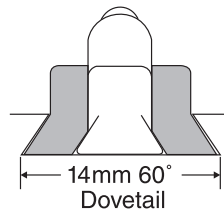

**Style F**

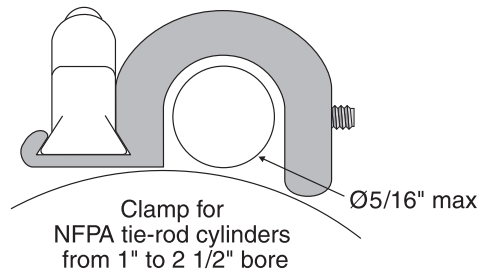

**Style G**

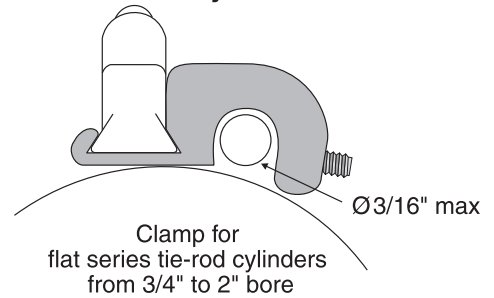

**Style J**

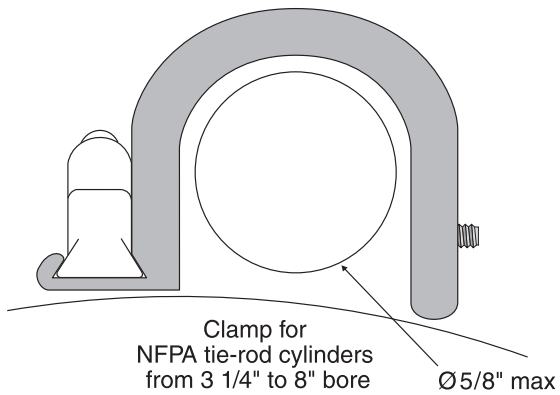

**Style H**

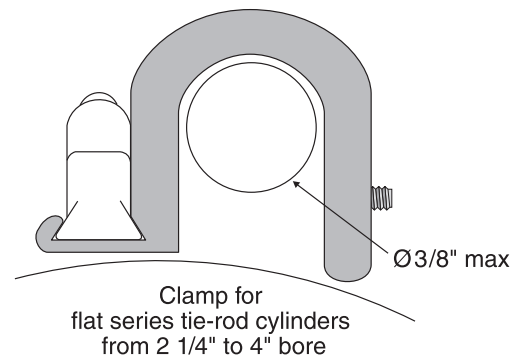



## Ordering Information

9 D 10 -  0 0 -

### Mounting Styles

- 0 - 1/4" 60° dovetail (standard)
- 1 - 12mm 60° dovetail adapter
- 2 - 3/8" 60° dovetail adapter
- 3 - Round cylinder clamp 3/4" - 4" bore
- 4 - 14mm 60° dovetail adapter
- F - NFPA tie-rod cylinder clamp 1" - 2 1/2" bore
- G - Flat series cylinder clamp 3/4" - 2" bore
- H - Flat series cylinder clamp 2 1/4" - 4" bore
- J - NFPA tie-rod cylinder clamp 3 1/4" - 8" bore

### Connection Options

- 0 - 9 ft PVC cable
- 3 - 8mm quick connect male pigtail\*

\*Mates with cordsets shown at right.

### Mating Cordsets

8mm female molded locking connectors

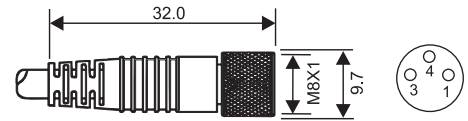

(for sensor types 01, 02, 04, 31, 32)

Order part number

- Brown = Pin 1
- Blue = Pin 3
- Black = Pin 4

- RC08S-F0M030120 (2m length)
- RC08S-F0M030150 (5m length)

Type	Description	Function	Switching Voltage	Switching Current	Switching Power	Switching Speed	Voltage Drop	Magnetic Sensitivity
01	Reed Switch	Normally Open	0 - 120V AC/DC 50/60 Hz	0.25 Amps Max.	5 watts Max.	0.4 ms operate 0.1 ms release	0 Volts	85 Ga.
02	Reed Switch for PLC's, LED (current limiting)	SPST Normally Open	5 - 120V AC/DC 50/60 Hz	0.03 Amps Max. 0.001 Amps Min.	4 watts Max.	0.4 ms operate 0.1 ms release	3.5 Volts @ 5mA	85 Ga.
04	Reed Switch, & LED	SPST Normally Open	5 - 120V AC/DC 50/60 Hz	0.20 Amps Max. 0.001 Amps Min.	5 watts Max.	0.4 ms operate 0.1 ms release	3.0 Volts	85 Ga.
31	Electronic for Reed Magnet, LED & Sourcing	Normally Open (PNP)	5 - 28 VDC	0.2 Amps Max.	4.8 watts Max.	4 µs operate 4 µs release	1.0 Volts	25 Ga.
32	Electronic for Reed Magnet, LED & Sinking	Normally Open (NPN)	5 - 28 VDC	0.2 Amps Max.	4.8 watts Max.	4 µs operate 4 µs release	1.0 Volts	25 Ga.



### SERIES 9D

Can-Pak Part Number	Qty	Function Normally Open	Switch Type
CP-9D10-000-002-010	10	SPST	Reed
CP-9D10-000-031-010	10	PNP	Electronic
CP-9D10-000-032-010	10	NPN	Electronic
CP-9D10-000-302-010	10	SPST	Reed
CP-9D10-000-331-010	10	PNP	Electronic
CP-9D10-000-332-010	10	NPN	Electronic

### Ordering Example:

9D10-000-002

1/4" dovetail, 9 ft. PVC cable, reed switch for PLC's with LED, SPST, normally open, 5 - 120V AC/DC 50/60 Hz

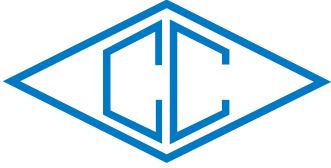

**canfield connector**  
8510 Foxwood Court  
Youngstown, Ohio 44514  
(330) 758-8299 Fax: (330) 758-8912  
www.canfieldconnector.com

## SERIES 9E

## REED & ELECTRONIC SENSORS FOR UNIVERSAL APPLICATIONS

### General Description

The Canfield Connector Series 9E is a universal, ultra-small, magnetic proximity switch available in both solid state electronic and reed styles. These sensors are designed to fit the most stringent space requirements by use of a standard .250 inch dovetail slot. Many other mounting options are also available. The electronic sensor exhibits greater sensitivity to magnetism with reduced dead-band and hysteresis as compared to competitive devices. The reed sensor offers a wide operating voltage range. The molded switch has an on board indicator light that can be viewed from wide angles. Standard connection to the sensor is provided by a 9 ft. PVC or 8mm quick connect male pigtail. The rugged 20% glass-filled polypropylene switch is shipped with mounting hardware ready for installation.

### Dimensional Data

ALL DIMENSIONS ARE IN MILLIMETERS UNLESS OTHERWISE NOTED

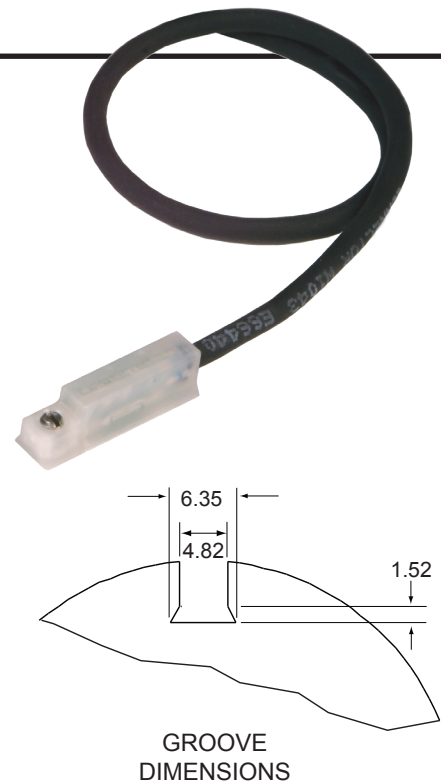
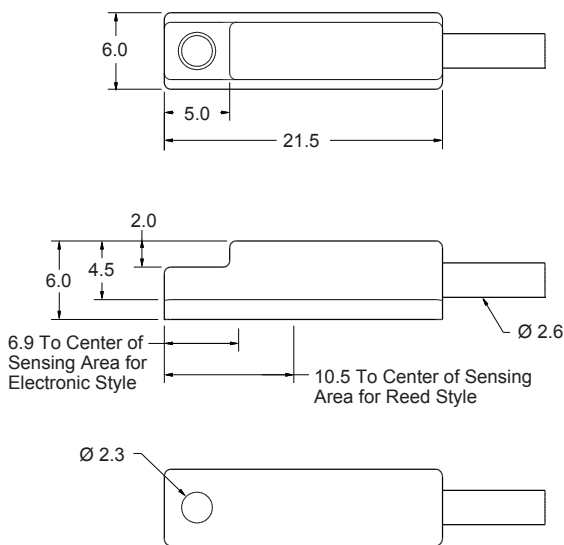

### Technical Data

- Temperature Range: Operational from -20° to +80°C
- Shock: Operational up to 30G (11 ms.) reeds only. Not applicable for electronic.
- Vibration: Operational up to 20G (10 - 55 Hz) reeds only. Not applicable for electronic.
- Most versions designed to meet NEMA 6 / IP67 specifications
- Sensitivity and Orientation: 85 gauss parallel (standard for reeds)  
25 gauss parallel (standard for electronic)

### Features

- Small sensor fits most space requirements.
- Stand-alone mounting into any 1/4" dovetail slot (machined or extruded)
- Other special mounting clamp styles available
- Indicator light
- Corrosion and washdown resistance.
- Electronic sensing version (no moving parts)
- Reverse polarity protection
- DC or AC voltage versions
- Compatible with IS (Intrinsically Safe) barriers
- Molded construction for wet environment (NEMA 6)
- Available for dovetail, round, tie-rod and rodless cylinder mountings.

**Style 0**

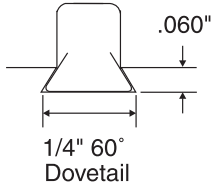

**Style 1**

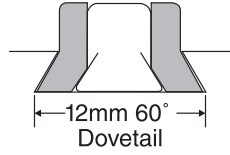

**Style 2**

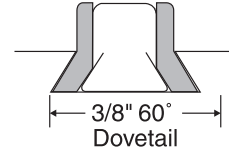

**Style 3**

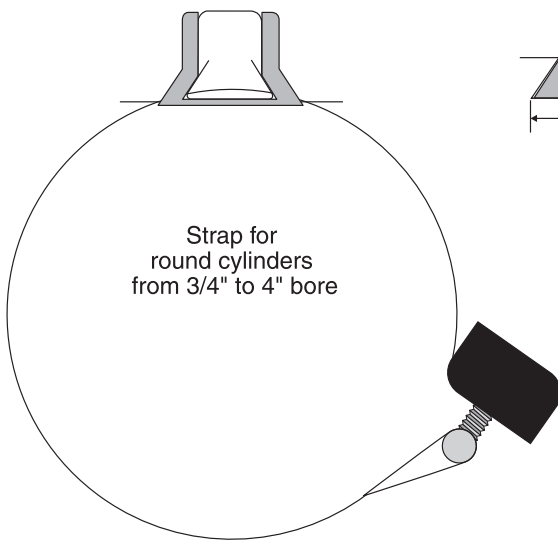

**Style 4**

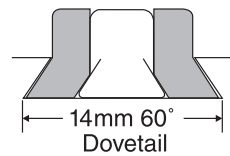

**Style F**

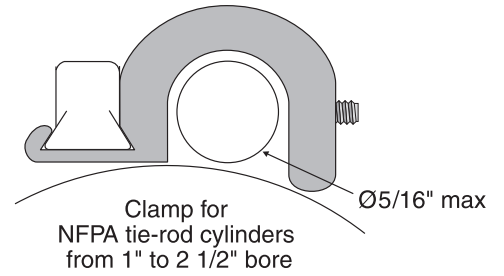

**Style G**

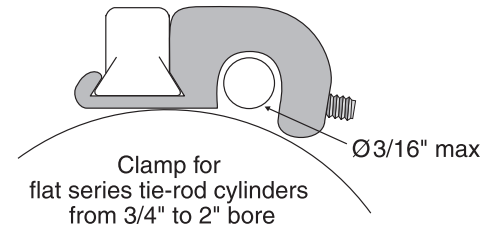

**Style J**

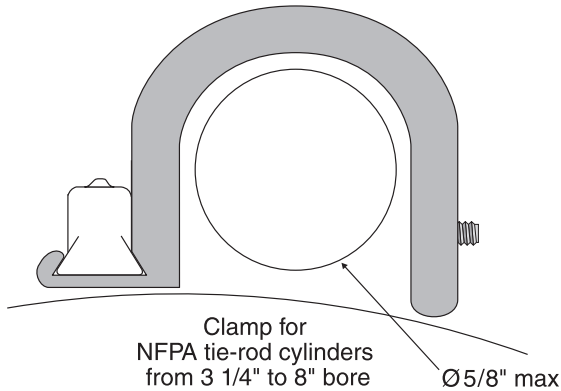

**Style H**

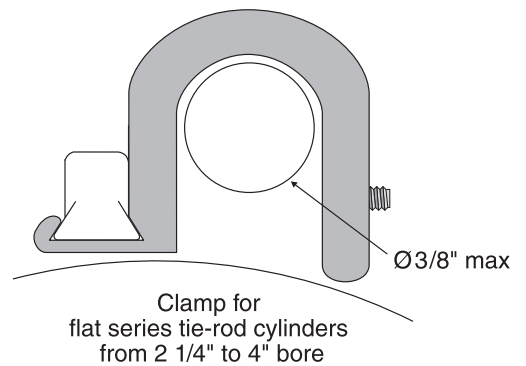

**Ordering Information**

9 E 1 0 -  0 0 -

**Mounting Styles**

- 0 - 1/4" 60° dovetail (standard)
- 1 - 12mm 60° dovetail adapter
- 2 - 3/8" 60° dovetail adapter
- 3 - Round cylinder clamp 3/4" - 4" bore
- 4 - 14mm 60° dovetail adapter
- F - NFPA tie-rod cylinder clamp 1" - 2 1/2" bore
- G - Flat series cylinder clamp 3/4" - 2" bore
- H - Flat series cylinder clamp 2 1/4" - 4" bore
- J - NFPA tie-rod cylinder clamp 3 1/4" - 8" bore

**Connection Options**

- 0 - 9 ft PVC cable
- 3 - 8mm quick connect male pigtail\*

\*Mates with cordsets shown at right.

**Mating Cordsets**

8mm female molded locking connectors

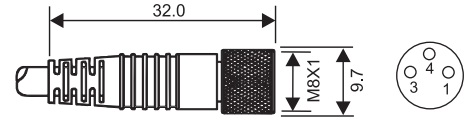

(for sensor types 01, 02, 31, 32)

**Order part number**

- Brown = Pin 1
- Blue = Pin 3
- Black = Pin 4

- RC08S-F0M030120 (2m length)
- RC08S-F0M030150 (5m length)

Type	Description	Function	Switching Voltage	Switching Current	Switching Power	Switching Speed	Voltage Drop	Magnetic Sensitivity
01	Reed Switch	SPST Normally Open	0 - 120V AC/DC 50/60 Hz	0.25 Amps Max.	5 watts Max.	0.4 ms operate 0.1 ms release	0 Volts	85 Ga.
02	Reed Switch for PLC's, LED (current limiting)	SPST Normally Open	5 - 120V AC/DC 50/60 Hz	0.03 Amps Max. 0.001 Amps Min.	4 watts Max.	0.4 ms operate 0.1 ms release	3.5 Volts @ 5mA	85 Ga.
31	Electronic for Reed Magnet, LED & Sourcing	Normally Open (PNP)	5 - 28 VDC	0.2 Amps Max.	4.8 watts Max.	4 µs operate 4 µs release	1.0 Volts	25 Ga.
32	Electronic for Reed Magnet, LED & Sinking	Normally Open (NPN)	5 - 28 VDC	0.2 Amps Max.	4.8 watts Max.	4 µs operate 4 µs release	1.0 Volts	25 Ga.



**SERIES 9E**

Can-Pak Part Number	Qty	Function Normally Open	Switch Type
CP-9E10-000-002-010	10	SPST	Reed
CP-9E10-000-031-010	10	PNP	Electronic
CP-9E10-000-032-010	10	NPN	Electronic
CP-9E10-000-302-010	10	SPST	Reed
CP-9E10-000-331-010	10	PNP	Electronic
CP-9E10-000-332-010	10	NPN	Electronic

**Ordering Example:**

9E10-000-002

1/4" dovetail, 9 ft. PVC cable, reed switch for PLC's with LED, SPST, normally open, 5 - 120V AC/DC 50/60 Hz

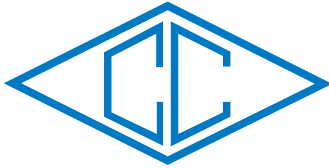

**canfield connector**  
8510 Foxwood Court  
Youngstown, Ohio 44514  
(330) 758-8299 Fax: (330) 758-8912  
www.canfieldconnector.com

## SERIES 9F

## REED & ELECTRONIC SENSORS FOR UNIVERSAL APPLICATIONS 4mm "T" SLOT

### General Description

The Canfield Connector Series 9F is a universal, ultra-small, magnetic proximity switch available in both solid state electronic and reed styles. These sensors are designed to fit the most stringent space requirements by using a 4mm "T" slot. The electronic sensor exhibits greater sensitivity to magnetism with reduced dead-band and hysteresis as compared to competitive devices. The reed sensor offers a wide operating voltage range. The molded switch has an on board indicator light that can be viewed from wide angles. Standard connection to the sensor is provided by a 9 ft. PVC or 8mm quick connect male pigtail. The rugged 20% glass-filled polypropylene switch is shipped with mounting hardware ready for installation.

### Dimensional Data

ALL DIMENSIONS ARE IN MILLIMETERS UNLESS OTHERWISE NOTED

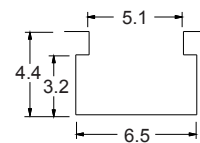
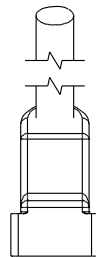
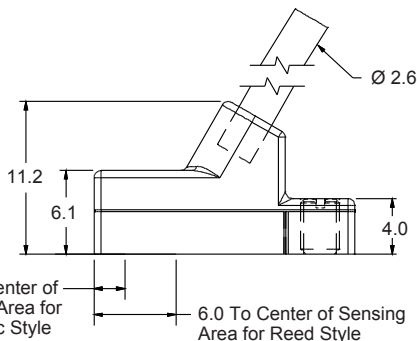
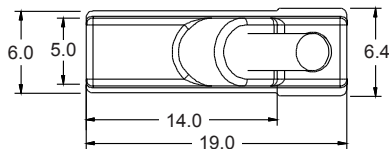

GROOVE  
DIMENSIONS

### Technical Data

- Temperature Range: Operational from -20° to +80°C
- Shock: Operational up to 30G (11 ms.) reeds only. Not applicable for electronic.
- Vibration: Operational up to 20G (10 - 55 Hz) reeds only. Not applicable for electronic.
- Most versions designed to meet NEMA 6 / IP67 specifications
- Sensitivity and Orientation: 85 gauss parallel (standard for reeds)  
25 gauss parallel (standard for electronic)

### Features

- Small sensor fits most space requirements.
- Stand-alone mounting into any 4mm "T" slot (machined or extruded)
- Indicator light
- Corrosion and washdown resistance.
- Electronic sensing version (no moving parts)
- 60° wire outlet for close mounting
- Reverse polarity protection
- Compatible with IS (Intrinsically Safe) barriers
- High temperature versions available

## Ordering Information

9 F 10 - 0 0 0 -

### Connection Options

- 0 - 9 ft PVC cable
- 3 - 8mm quick connect male pigtail\*

\*Mates with cordsets shown at right.

### Mating Cordsets

8mm female molded locking connectors

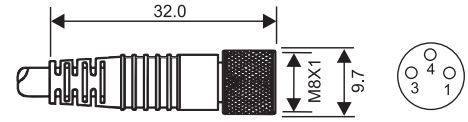

(for sensor types 01, 02, 04, 31, 32)

### Order part number

Brown = Pin 1  
Blue = Pin 3  
Black = Pin 4

RC08S-F0M030120 (2m length)  
RC08S-F0M030150 (5m length)

Type	Description	Function	Switching Voltage	Switching Current	Switching Power	Switching Speed	Voltage Drop	Magnetic Sensitivity
01	Reed Switch	Normally Open	0 - 120V AC/DC 50/60 Hz	0.25 Amps Max.	5 watts Max.	0.4 ms operate 0.1 ms release	0 Volts	85 Ga.
02	Reed Switch for PLC's, LED (current limiting)	SPST Normally Open	5 - 120V AC/DC 50/60 Hz	0.03 Amps Max. 0.001 Amps Min.	4 watts Max.	0.4 ms operate 0.1 ms release	3.5 Volts @ 5mA	85 Ga.
04	Reed Switch, & LED	SPST Normally Open	5 - 120V AC/DC 50/60 Hz	0.20 Amps Max. 0.001 Amps Min.	5 watts Max.	0.4 ms operate 0.1 ms release	3.0 Volts	85 Ga.
31	Electronic for Reed Magnet, LED & Sourcing	Normally Open (PNP)	5 - 28 VDC	0.2 Amps Max.	4.8 watts Max.	4 µs operate 4 µs release	1.0 Volts	25 Ga.
32	Electronic for Reed Magnet, LED & Sinking	Normally Open (NPN)	5 - 28 VDC	0.2 Amps Max.	4.8 watts Max.	4 µs operate 4 µs release	1.0 Volts	25 Ga.

### Ordering Example:

9F10-000-002

9 ft. PVC cable, reed switch for PLC's with LED,  
SPST, normally open, 5 - 120V AC/DC 50/60 Hz

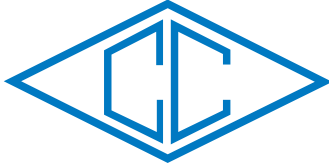

**canfield connector**  
 8510 Foxwood Court  
 Youngstown, Ohio 44514  
 (330) 758-8299 Fax: (330) 758-8912  
 www.canfieldconnector.com

**SERIES 9G**

**REED & ELECTRONIC SENSORS  
 FOR 6.3MM "T" SLOT APPLICATIONS**

**General Description**

The Canfield Connector 9G linear magnetic position sensor is designed to work with aluminum extrusion type actuators that have a 6.2mm X 4.4mm rectangular groove designed into the body. Available in reed or electronic versions, the 9G fits into commonly used sensor grooves. Standard connection to the sensor is provided by a 9 ft. PVC or 8mm quick connect male pigtail. The switch is water resistant and dust tight to IP-67.

**Dimensional Data**

ALL DIMENSIONS ARE IN MILLIMETERS UNLESS OTHERWISE NOTED

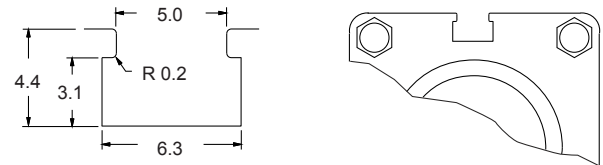
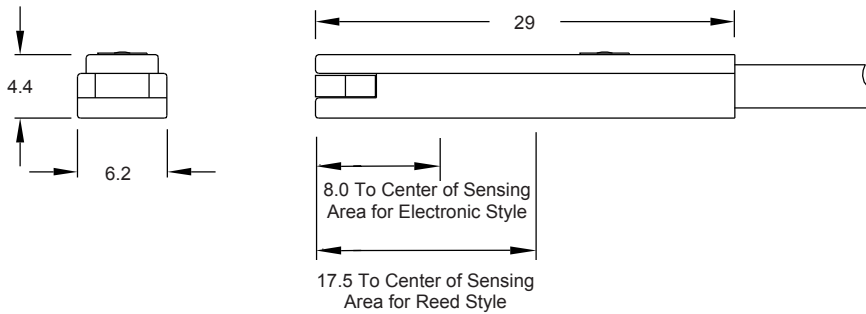
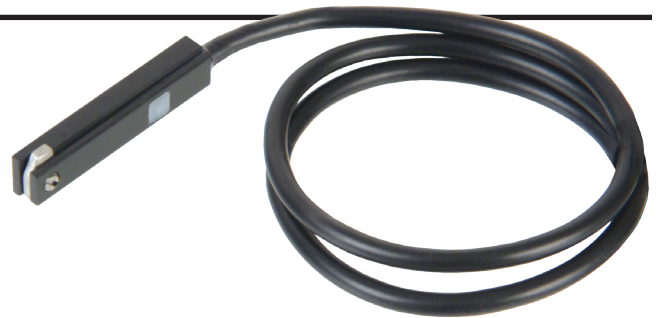

GROOVE DIMENSIONS

**Technical Data**

- Temperature Range: Operational from -10° to +70°C
- Shock: Operational up to 30G reed and up to 50G for electronic
- Vibration: Operational up to 9G reed and electronic
- All versions designed to meet NEMA 6 / IP67 specifications
- Sensitivity and Orientation: 40 gauss parallel (electronic)  
60 gauss parallel (reed)

**Features**

- T-slot body to fit many popular linear actuators
- All encapsulated body resists environment and vibration
- Available in Reed NPN or PNP Electronic versions
- Reverse polarity protection
- Quick connect versions

## Ordering Information

9G10-000-□□□

### Connection Options

- 0 - 9 ft PVC cable
- 3 - 8mm quick connect male pigtail\*

\*Mates with cordsets shown at right.

### Mating Cordsets

8mm female molded locking connectors

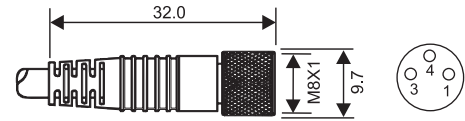

(for sensor types 02, 31, 32)

### Order part number

Brown = Pin 1  
Blue = Pin 3  
Black = Pin 4

RC08S-F0M030120 (2m length)  
RC08S-F0M030150 (5m length)

Switch Type	Description	Function	Switching Voltage	Switching Current	Switching Power	Voltage Drop	Magnetic Sensitivity
02	Reed Switch with Red LED	SPST	5-240V AC/DC	0.1 Amps Max.	10 watts Max.	2.5 Volts @ 100 mA DC	40 Ga.
31	Electronic for Reed Magnet, with Grn LED & Sourcing	PNP	5-28 VDC	0.2 Amps Max.	6 watts Max.	1.5 Volts @ 200 mA	60 Ga.
32	Electronic for Reed Magnet, with Red LED & Sinking	NPN	5-28 VDC	0.2 Amps Max.	6 watts Max.	1.5 Volts @ 200 mA	60 Ga.

### Ordering Example:

9G10-000-002

9 ft. PVC cable, reed switch with red LED,  
SPST, 5 - 240V AC/DC 50/60 Hz



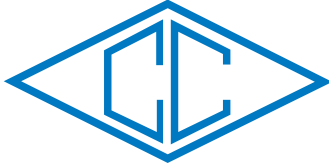

**canfield connector**  
8510 Foxwood Court  
Youngstown, Ohio 44514  
(330) 758-8299 Fax: (330) 758-8912  
www.canfieldconnector.com

## SERIES 9H

## REED & ELECTRONIC MAGNETIC SENSORS FOR 4.2MM "T" SLOT APPLICATIONS

### General Description

The Canfield Connector Series 9H is a profile mounting type switch that fits in a 4mm X 4mm square groove which normally is designed into an aluminum extrusion type linear actuator. Available in reed or electronic versions, the 9H is also available with a 9 ft. PVC or 8mm quick connect male pigtail. The switch is IP-67 which is dust tight and water resistant.

### Dimensional Data

ALL DIMENSIONS ARE IN MILLIMETERS UNLESS OTHERWISE NOTED

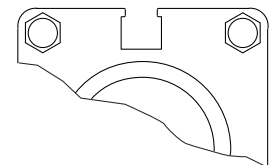
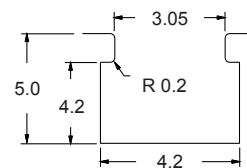
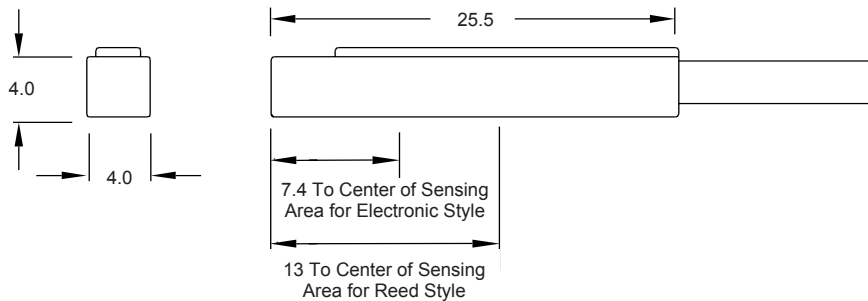

GROOVE  
DIMENSIONS

### Technical Data

- Temperature Range: Operational from -10° to +70°C
- Shock: Operational up to 30G reed and up to 50G for electronic
- Vibration: Operational up to 9G reed and electronic
- All versions designed to meet NEMA 6 / IP67 specifications
- Sensitivity and Orientation: 40 gauss parallel (electronic)  
60 gauss parallel (reed)

### Features

- Small sensor fits most space requirements.
- Indicator light
- Corrosion and washdown resistance
- Electronic sensing version (no moving parts)
- Reverse polarity protection
- CE approved
- AC/DC for reed. DC only for electronic
- Compatible with IS (Intrinsically Safe) barriers

9H10-000-□□□

**Connection Options**

- 0 - 9 ft PVC cable
- 3 - 8mm quick connect male pigtail\*

\*Mates with cordsets shown at right.

**Mating Cordsets**

8mm female molded locking connectors

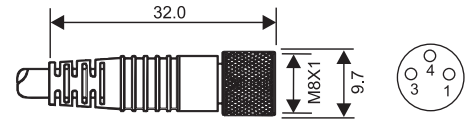

(for sensor types 02, 31, 32)

**Order part number**

- Brown = Pin 1
- Blue = Pin 3
- Black = Pin 4

- RC08S-F0M030120 (2m length)
- RC08S-F0M030150 (5m length)

Type	Description	Function	Switching Voltage	Switching Current	Switching Power	Voltage Drop	Magnetic Sensitivity
02	Reed Switch with Red LED	SPST	5 - 120V AC/DC	0.1 Amps Max.	10 watts Max.	2.5 Volts @ 100mA	60 Ga.
31	Electronic for Reed Magnet, with Grn LED & Sourcing	PNP	5 - 28 VDC	0.2 Amps Max.	6 watts Max.	.5 Volts @ 200 mA	40 Ga.
32	Electronic for Reed Magnet, with Red LED & Sinking	NPN	5 - 28 VDC	0.2 Amps Max.	6 watts Max.	.5 Volts @ 200 mA	40 Ga.

**Ordering Example:**

9H10-000-002

9 ft. PVC cable, reed switch wiyh red LED, SPST, 5 - 120V AC/DC 50/60 Hz

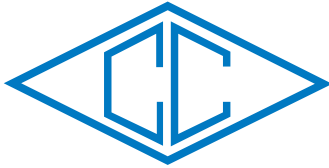

**canfield connector**  
8510 Foxwood Court  
Youngstown, Ohio 44514  
(330) 758-8299 Fax: (330) 758-8912  
www.canfieldconnector.com

## SERIES 9M50

## REED & ELECTRONIC SENSORS FOR 6.5MM GROOVE APPLICATIONS

### General Description

The Canfield Connector 9M50 is a compact full featured magnetic proximity switch designed to fit a "D" shaped groove detail designed into linear actuators. The innovative design allows the switch to be inserted anywhere along the linear actuator and then rotated and locked into position. When installed the switch lies flat against the cylinder housing and does not protrude beyond the cylinder face making installations neat and clean. The fully encapsulated switch is offered in reed, and electronic styles in either NPN or PNP. The robust epoxy encapsulated design meets IP67, NEMA 6 environmental protection. Voltage ranges are available from 5 to 120 VAC/DC in multiple versions. Maximum current draw is 200 mA. Standard connection is provided by a 9 ft. PVC or 8mm quick connect male pigtail.

### Dimensional Data

ALL DIMENSIONS ARE IN MILLIMETERS UNLESS OTHERWISE NOTED

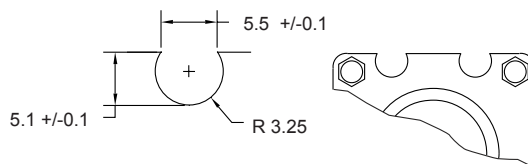
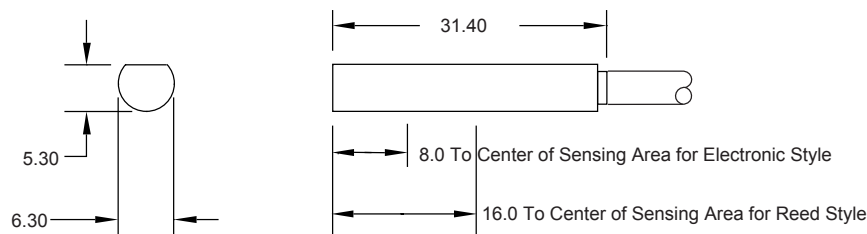

GROOVE  
DIMENSIONS



### Technical Data

- Temperature Range: Operational from -10° to +70°C
- Shock: Operational up to 30G reed and up to 50G for electronic
- Vibration: Operational up to 9G reed and electronic
- All versions designed to meet NEMA 6 / IP67 specifications
- Sensitivity and Orientation: 40 gauss parallel (electronic)  
60 gauss parallel (reed)

### Features

- Small sensor fits most space requirements.
- Indicator light
- Corrosion and washdown resistance.
- Electronic sensing version (no moving parts)
- Reverse polarity protection
- CE approved
- DC or AC voltage versions
- Compatible with IS (Intrinsically Safe) barriers
- Molded construction for wet environment (NEMA 6)
- Available in Normally Closed versions

## Ordering Information

9 M 5 0 1 0 - 0 0 0 -

### Connection Options

- 0 - 9 ft PVC cable
- 3 - 8mm quick connect male pigtail\*

\*Mates with cordsets shown at right.

### Mating Cordsets

8mm female molded locking connectors

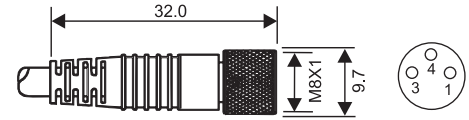

(for sensor types 02, 31, 32)

Order part number

Brown = Pin 1

Blue = Pin 3

Black = Pin 4

RC08S-F0M030120 (2m length)

RC08S-F0M030150 (5m length)

Type	Description	Function	Switching Voltage	Switching Current	Switching Power	Voltage Drop	Magnetic Sensitivity
02	Reed Switch with Red LED	SPST	5 - 120V AC/DC	0.1 Amps Max.	10 watts Max.	2.5 Volts @ 100mA	40 Ga.
31	Electronic for Reed Magnet, with Grn LED & Sourcing	PNP	5 - 28 VDC	0.2 Amps Max.	6 watts Max.	1.5 Volts @ 200 mA	60 Ga.
32	Electronic for Reed Magnet, with Red LED & Sinking	NPN	5 - 28 VDC	0.2 Amps Max.	6 watts Max.	1.5 Volts @ 200 mA	60 Ga.

### Ordering Example:

9M5010-000-002

9 ft. PVC cable, reed switch with red LED, SPST, 5 - 120V AC/DC 50/60 Hz

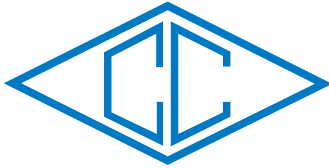

**canfield connector**  
 8510 Foxwood Court  
 Youngstown, Ohio 44514  
 (330) 758-8299 Fax: (330) 758-8912  
 www.canfieldconnector.com

## SERIES 9N

## REED & ELECTRONIC SENSORS FOR 4.25MM ROUND GROOVE APPLICATIONS

### General Description

The Canfield Connector 9N is a right angle version of the popular 4.25mm round groove type switches commonly used in aluminum extrusion type linear actuators. The 9N features reed or electronic versions and are available in standard 9 ft. PVC or 8mm quick connect male pigtail. The 9N is IP-67 which makes it dust tight and water resistant.

### Dimensional Data

ALL DIMENSIONS ARE IN MILLIMETERS UNLESS OTHERWISE NOTED

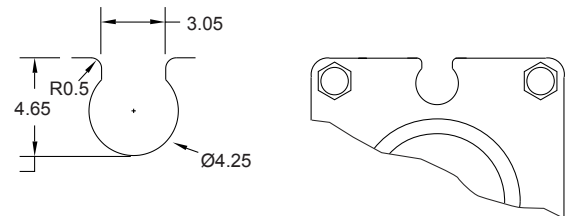
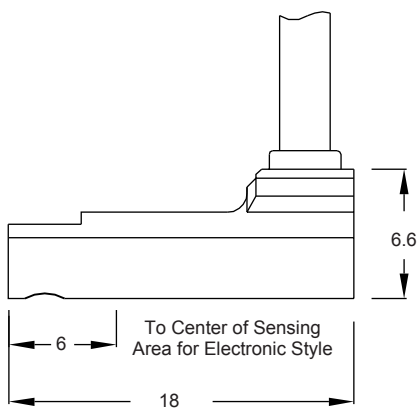
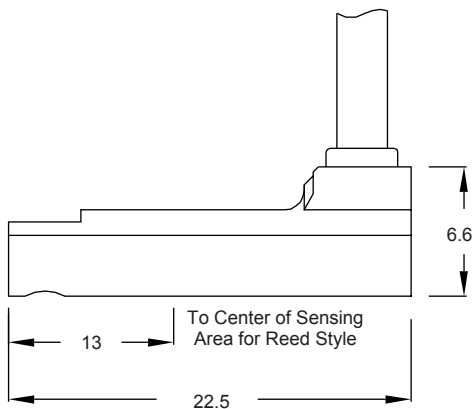

GROOVE DIMENSIONS

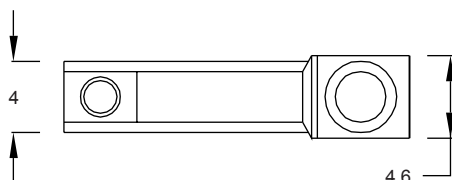

### Features

- Small sensor fits most space requirements.
- Indicator light
- Corrosion and washdown resistance.
- Electronic sensing version (no moving parts)
- Reverse polarity protection
- CE approved
- AC/DC for reed versions, DC only for electronic

## Technical Data

- Temperature Range: Operational from -10° to +70°C
- Shock: Operational up to 30G reed and up to 50G for electronic
- Vibration: Operational up to 9G reed and electronic
- All versions designed to meet NEMA 6 / IP67 specifications
- Sensitivity and Orientation: 40 gauss parallel (electronic)  
60 gauss parallel (reed)

## Ordering Information

9N10-000-□□□

### Connection Options

- 0 - 9 ft PVC cable
- 3 - 8mm quick connect male pigtail\*

\*Mates with cordsets shown at right.

### Mating Cordsets

8mm female molded locking connectors

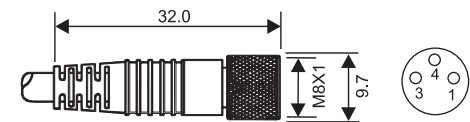

(for sensor types 02, 31, 32)

### Order part number

Brown = Pin 1  
Blue = Pin 3  
Black = Pin 4

RC08S-F0M030120 (2m length)  
RC08S-F0M030150 (5m length)

Switch Type	Description	Function	Switching Voltage	Switching Current	Switching Power	Voltage Drop	*Magnetic Sensitivity
02	Reed Switch with Red LED	SPST	5-120V AC/DC	0.1 Amps Max.	10 watts Max.	2.5 Volts @ 40 mA DC	60 Ga.
31	Electronic for Reed Magnet, with Grn LED & Sourcing	PNP	5-28 VDC	0.2 Amps Max.	6 watts Max.	.5 Volts @ 200 mA	40 Ga.
32	Electronic for Reed Magnet, with Red LED & Sinking	NPN	5-28 VDC	0.2 Amps Max.	6 watts Max.	.5 Volts @ 200 mA	40 Ga.

### Ordering Example:

9N10-000-002

9 ft. PVC cable, reed switch with red LED,  
SPST, 5 - 120V AC/DC 50/60 Hz

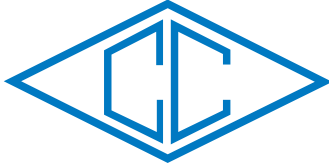

**canfield connector**  
8510 Foxwood Court  
Youngstown, Ohio 44514  
(330) 758-8299 Fax: (330) 758-8912  
www.canfieldconnector.com

## SERIES 9T

## REED & ELECTRONIC MAGNETIC SENSORS FOR 7.2MM "T" SLOT APPLICATIONS

### General Description

The Canfield Connector Series 9T is a compact yet robust switch used to sense position of magnetic pistons designed into aluminum extrusion type linear actuators. The 9T fits a 7.2mm X 3.9mm rectangular groove which is designed into the actuator body. Available in reed or electronic versions, the 9T features standard 9 ft. PVC or 8mm quick connect male pigtail, and are rated IP-67 against the ingress of dust and water.

### Dimensional Data

ALL DIMENSIONS ARE IN MILLIMETERS UNLESS OTHERWISE NOTED

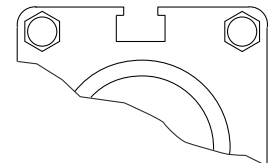
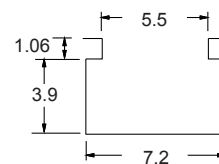
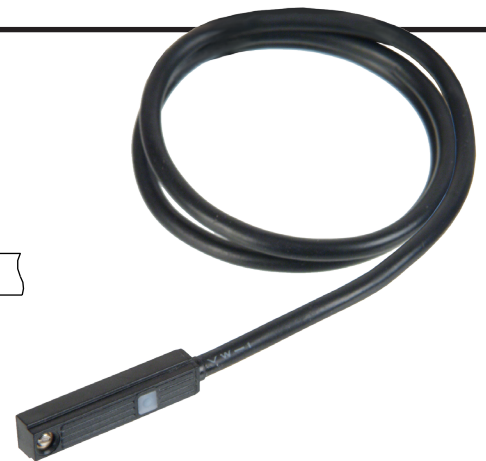
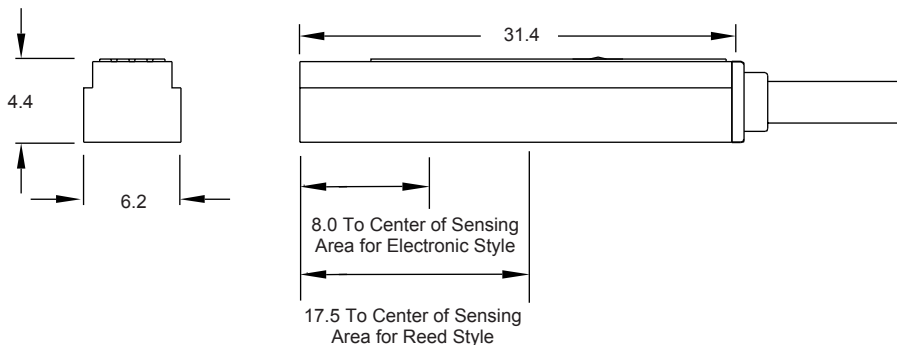

GROOVE  
DIMENSIONS

### Technical Data

- Temperature Range: Operational from -10° to +70°C
- Shock: Operational up to 30G reed and up to 50G for electronic
- Vibration: Operational up to 9G reed and electronic
- All versions designed to meet NEMA 6 / IP67 specifications
- Sensitivity and Orientation: 40 gauss parallel

### Features

- Small sensor fits most space requirements.
- Indicator light
- Corrosion and washdown resistance.
- Electronic sensing version (no moving parts)
- Reverse polarity protection
- CE approved
- AC/DC for reed. DC only for electronic
- Compatible with IS (Intrinsically Safe) barriers
- Molded construction for wet environment (NEMA 6)

## Ordering Information

9T10-000- □ □ □

### Connection Options

- 0 - 9 ft PVC cable
- 3 - 8mm quick connect male pigtail\*

\*Mates with cordsets shown at right.

### Mating Cordsets

8mm female molded locking connectors

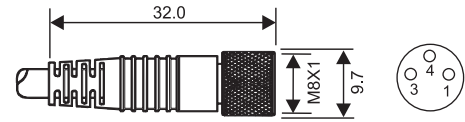

(for sensor types 02, 31, 32)

### Order part number

Brown = Pin 1  
Blue = Pin 3  
Black = Pin 4

RC08S-F0M030120 (2m length)  
RC08S-F0M030150 (5m length)

Type	Description	Function	Switching Voltage	Switching Current	Switching Power	Voltage Drop	Magnetic Sensitivity
02	Reed Switch with Red LED	SPST	5 - 240V AC/DC	0.1 Amps Max.	10 watts Max.	2.5 Volts @ 100mA	60 Ga.
31	Electronic for Reed Magnet, with Grn LED & Sourcing	PNP	5 - 28 VDC	0.2 Amps Max.	6 watts Max.	.5 Volts @ 200 mA	40 Ga.
32	Electronic for Reed Magnet, with Red LED & Sinking	NPN	5 - 28 VDC	0.2 Amps Max.	6 watts Max.	.5 Volts @ 200 mA	40 Ga.

### Ordering Example:

9T10-000-002

9 ft. PVC cable, reed switch with red LED, SPST, 5 - 240V AC/DC 50/60 Hz



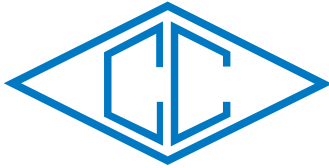

**canfield connector**  
 8510 Foxwood Court  
 Youngstown, Ohio 44514  
 (330) 758-8299 Fax: (330) 758-8912  
 www.canfieldconnector.com

**B-TYPE / SENSOR CONNECTORS**

FOR USE WITH CANFIELD  
 PROXIMITY DEVICES

**Dimensional Data**

ALL DIMENSIONS ARE IN MILLIMETERS UNLESS OTHERWISE NOTED

**12mm Female Molded Locking Connector**  
 250V AC/DC 4 Amps max.

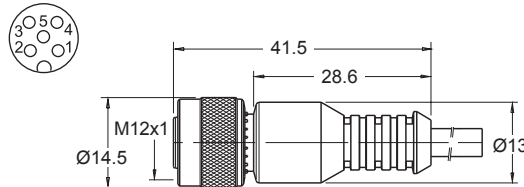

Order part number

- RC12S-F0M030120 (3 pin / 2m)**
- RC12S-F0M030150 (3 pin / 5m)**

**12mm Male x 12mm Female Molded Locking Cable**  
 250V AC/DC 4 Amps max.

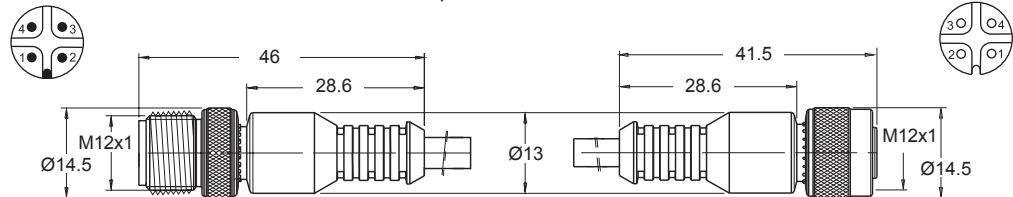

Order part number

- RCA-12SM00-12SF0041 (4 pin / 1m)**
- RCA-12SM00-12SF0042 (4 pin / 2m)**

**12mm Female Field Wireable Connector**  
 250V AC/DC 3 Amps max.

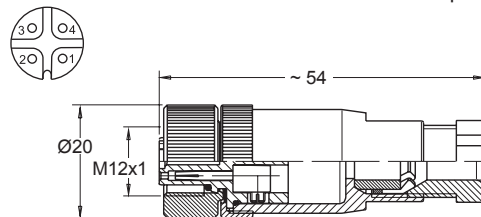

Order part number

- RC12B-F0F0400 (4 pin / 4-6mm cable dia.)**
- RC12B-F0F0401 (4 pin / 6-8mm cable dia.)**

**12mm Male Field Wireable Connector**  
 250V AC/DC 3 Amps max.

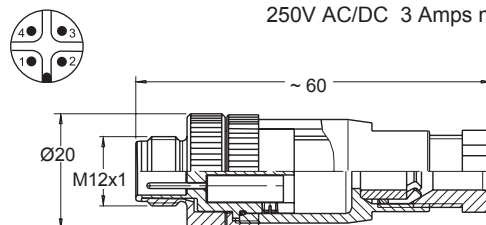

Order part number

- RC12B-M0F0400 (4 pin / 4-6mm cable dia.)**
- RC12B-M0F0401 (4 pin / 6-8mm cable dia.)**

B  
T  
Y  
P  
E

## Dimensional Data

ALL DIMENSIONS ARE IN MILLIMETERS UNLESS OTHERWISE NOTED

### 8mm Female Molded Locking Connector 120V AC/DC 4 Amps max.

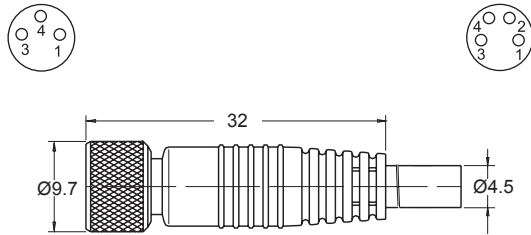

Order part number

**RC08S-F0M030120** (3 pin / 2m)

**RC08S-F0M030150** (3 pin / 5m)

**RC08S-F0M040120** (4 pin / 2m)

**RC08S-F0M040150** (4 pin / 5m)

### 12mm Male x 8mm Female Molded Locking Cable 120V AC/DC 4 Amps max.

N/C on Pin 2

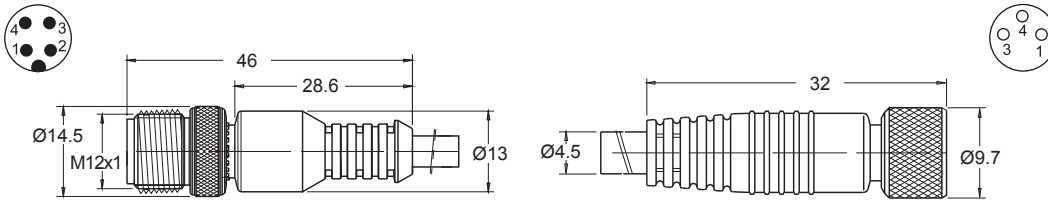

Order part number

**RCA-12SM00-08SF0031** (3 pin / 1m)

**RCA-12SM00-08SF0032** (3 pin / 2m)



### 8mm Female Field Wireable Connector 120V AC/DC 4 Amps max.

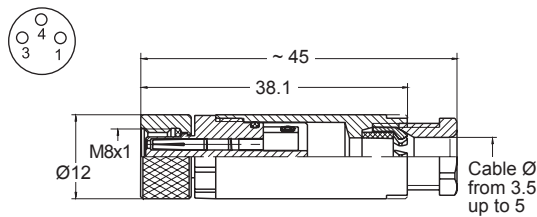

Order part number

**RC08B-F0F0330** (3 pin)

### 8mm Male Field Wireable Connector 120V AC/DC 4 Amps max.

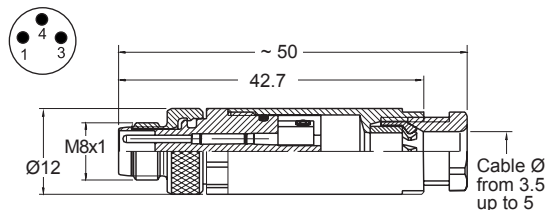

Order part number

**RC08B-M0F0330** (3 pin)

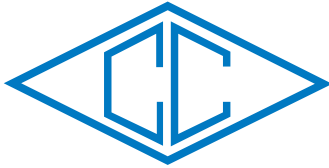

**canfield connector**  
 8510 Foxwood Court  
 Youngstown, Ohio 44514  
 (330) 758-8299 Fax: (330) 758-8912  
 www.canfieldconnector.com

## MODEL OSV

## OPTICAL SENSOR VALVE PHOTO-EYE ACCUMULATION SYSTEM

### General Description

The Canfield Connector Model OSV is a fully-modular, easily-installable, optical sensor and valve combination for conveyor automation. This unit is designed for sensing objects moving through conveyor zones in order to maximize product flow while preventing product damage. By incorporating solid-state electronics and a low wattage solenoid valve, the OSV uses logic and manual inputs to reliably control a pneumatic actuator. The actuator either extends or retracts, controlling the movement of the conveyor zone. Features include adjustable sensitivity and output delay with LEDs to facilitate troubleshooting and a visual display of sensor modes. These LEDs indicate power status, beam alignment, beam clear, object detected, valve output, and slug mode. The modular design allows easy component replacement. The OSV is a reliable alternative to expensive, high-maintenance, pneumatic accumulation zones.



### Dimensional Data

ALL DIMENSIONS ARE IN MILLIMETERS UNLESS OTHERWISE NOTED

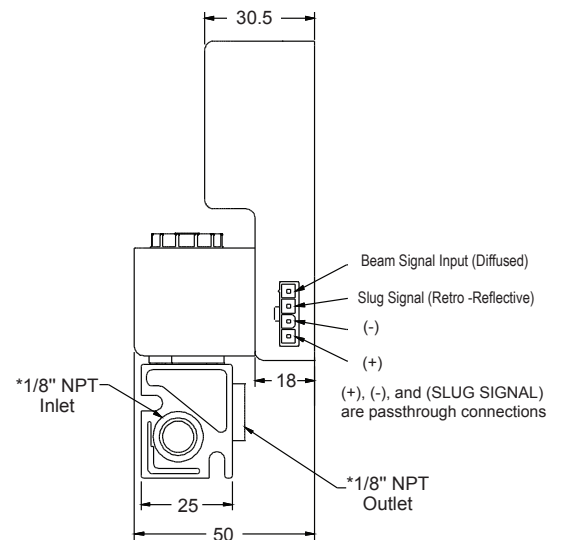
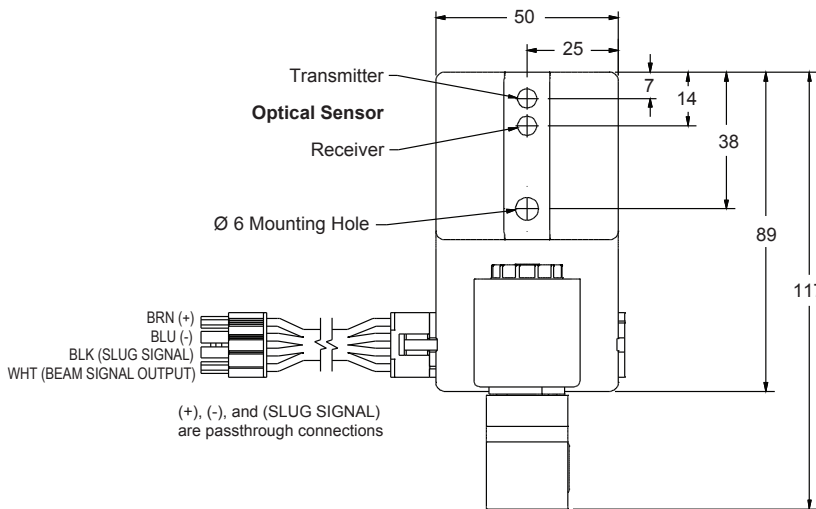

**\*WARNING -**  
 When using metal fittings do not exceed 40 in. lbs. torque or material failure can occur

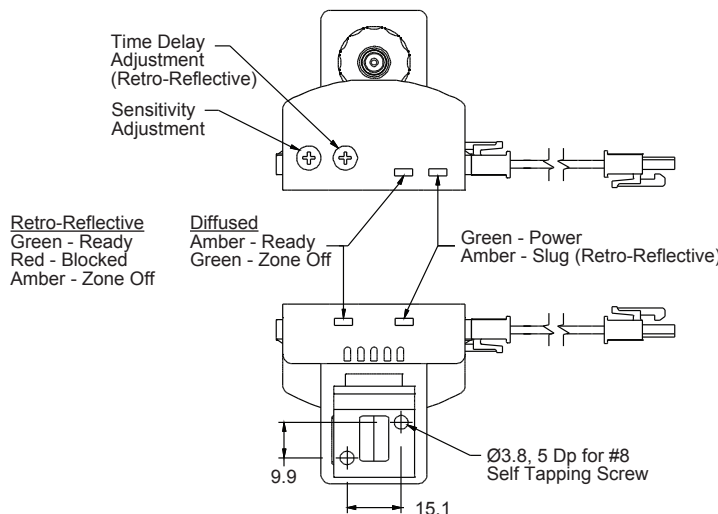

Consult factory for available versions listed by Canadian Standards Association for use with certified electrical equipment.

OSV

## Features

- Designed for minimal installation / setup
- Sensing distances up to 6 ft. (retro-reflective)
- Detection of a wide variety of materials
- Cascadable up to 100 units
- Adjustable (0.02 - 3 sec) valve time delay (retro-reflective)
- Adjustable sensitivity
- Multi-color intelligent indicators for diagnostics / status
- Infrared light technology
- Optional wire lengths

## Technical Data

- Supply Voltage: 20 - 28 VDC
- Supply Current: 65mA with 0.9W coil energized
- Slug Signal (input): 12 $\mu$ A max. per sensor sinking (NPN) (retro-reflective)
- Beam Signal (input): 5mA max. sourcing (PNP) (diffused)
- Beam Signal (output): 200mA max. sinking (NPN)
- Valve Orifice / Pressure: 1.0mm / 0 - 30 psi
- Valve Type: Normally Closed
- Operating Temperature: -10 to 50° C

## Function

### Retro-Reflective Accumulation

#### Retro-Reflective Accumulation

##### Normally Open Operation

When Beam is CLEAR (no object detected)

- 1) Status LED is GREEN
- 2) Valve is OPEN
- 3) Beam Signal is ON (sinking 200mA max)

When Beam is BLOCKED (object detected)

- 1) Status LED turn RED for the set amount of time delay (0.02 - 3sec) then turns AMBER
- 2) Valve CLOSES after the set time delay
- 3) Beam Signal turns off immediately (no time delay)
- 4) If an override is needed, a GND signal to the Slug Input will OPEN all valves connected inline

##### Normally Closed Operation

When Beam is CLEAR (no object detected)

- 1) Status LED is GREEN
- 2) Valve is CLOSED
- 3) Beam Signal is ON (sinking 200mA max)

When Beam is BLOCKED (object detected)

- 1) Status LED turn RED for the set amount of time delay (0.02 - 3sec) then turns AMBER
- 2) Valve OPENS after the set time delay
- 3) Beam Signal turns off immediately (no time delay)
- 4) If an override is needed, a GND signal to the Slug Input will CLOSE all valves connected inline

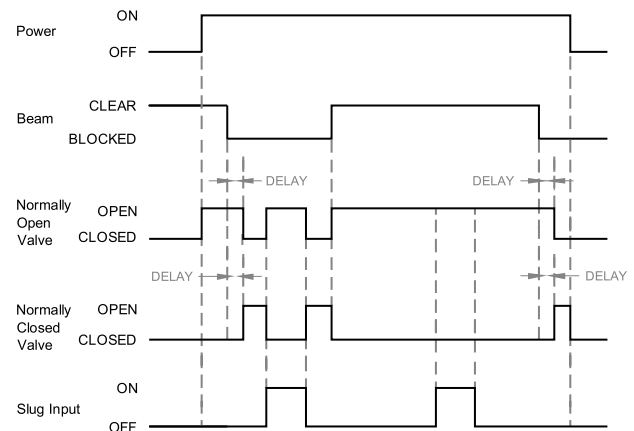

### Diffused Accumulation (no time delay or slug)

#### Diffused Accumulation

##### Normally Open Operation

When Beam is CLEAR (no object detected)

- 1) Status LED is AMBER
- 2) Valve is OPEN
- 3) Beam Signal is ON (sinking 200mA max)

When Beam is BLOCKED (object detected)

- 1) Status LED is GREEN (no time delay)
- 2) Valve is CLOSED (no time delay)
- 3) Beam Signal turns off immediately (no time delay)

##### Normally Closed Operation

When Beam is CLEAR (no object detected)

- 1) Status LED is AMBER
- 2) Valve is CLOSED
- 3) Beam Signal is ON (sinking 200mA max)

When Beam is BLOCKED (object detected)

- 1) Status LED is GREEN (no time delay)
- 2) Valve is OPEN (no time delay)
- 3) Beam Signal turns off immediately (no time delay)

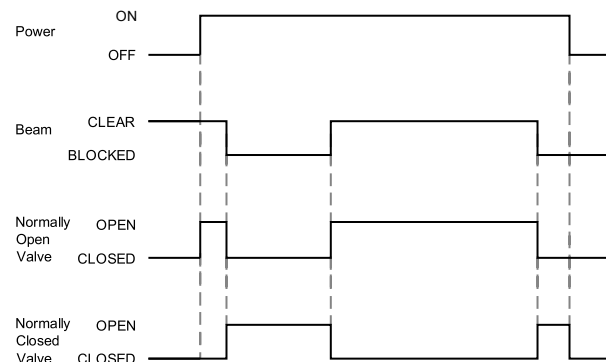

\*Beam Status Signal follows the pattern as the Beam itself. When the Beam is clear the Beam Status Signal is ON.

## Retro-Reflective Indexing Normally Closed

### Retro-Reflective Indexing

#### Normally Closed Operation

Downstream Sensor Beam is CLEAR (no object detected)

- 1) Downstream Sensor Status LED is GREEN
- 2) Downstream Sensor valve is CLOSED
- 3) Downstream Sensor Beam Signal is LOW providing a CLEAR signal to the Upstream sensor
- 4) Upstream Sensor valve is CLOSED no matter if its beam is CLEAR or BLOCKED

Downstream Sensor Beam is BLOCKED (object detected)

- 1) Downstream Sensor Status LED turns RED for the set time delay (0.02 - 3sec) then turns AMBER
- 2) Downstream Sensor valve OPENS after the set time delay
- 3) Downstream Sensor Beam Signal immediately changes HIGH (no time delay), providing a BLOCKED signal to the Upstream Sensor
- 4) Upstream Sensor valve is CLOSED until its Beam is BLOCKED
- 5) If both Downstream and Upstream sensors are BLOCKED their valves will be OPEN
- 6) If an override is needed, a GND signal to the Slug Input will CLOSE all valves connected inline

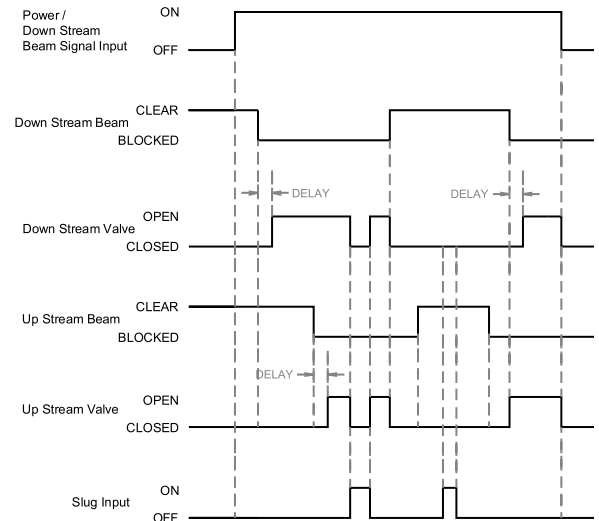

## Diffused Indexing Normally Closed (no time delay or slug)

### Diffused Indexing

#### Normally Closed Operation

Downstream Sensor Beam is CLEAR (no object detected)

- 1) Downstream Sensor status LED is AMBER
- 2) Downstream Sensor valve is CLOSED
- 3) Downstream Sensor Beam Signal is LOW, providing a CLEAR signal to the Upstream sensor
- 4) Upstream Sensor valve is CLOSED no matter if its beam is CLEAR or BLOCKED

Downstream Sensor Beam is BLOCKED (object detected)

- 1) Downstream Sensor Status LED turns GREEN (no time delay)
- 2) Downstream Sensor valve OPENS (no time delay)
- 3) Downstream Sensor Beam Signal immediately changes HIGH (no time delay), providing a BLOCKED signal to the Upstream Sensor
- 4) Upstream Sensor valve is CLOSED until its Beam is BLOCKED
- 5) If both Downstream and Upstream sensors are BLOCKED their valves will be OPEN
- 6) To release the LAST Downstream sensor, apply a 24VDC signal to the Beam Signal Input wire. (This only releases the last downstream sensor, no other sensors are affected)

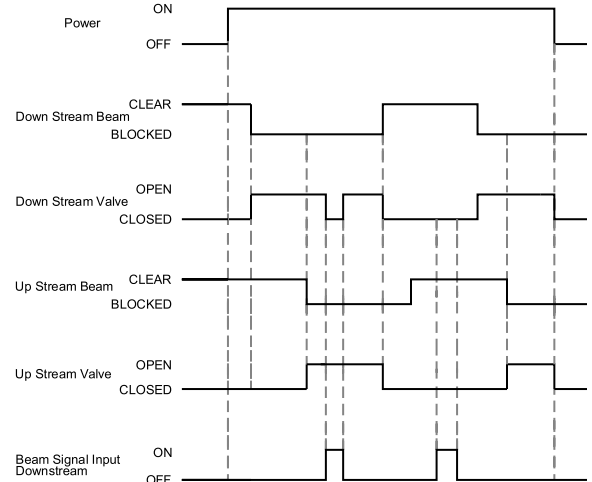

## Ordering Information

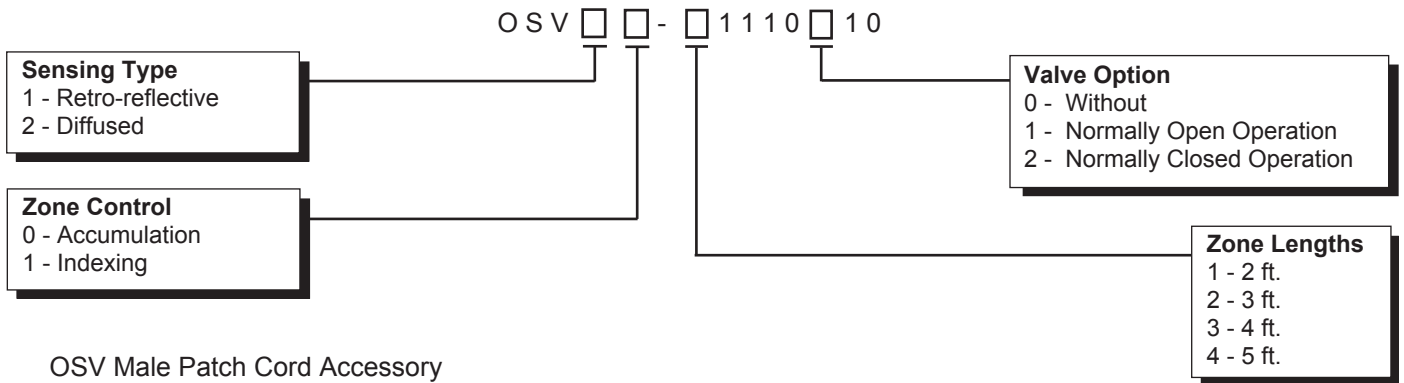

OSV Male Patch Cord Accessory

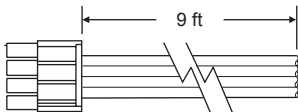

**WOSV10-910**

Retro Reflector - **OSVR10-002**

Custom zone lengths available, consult factory.

### Ordering Example:

**OSV10-11110010**

Retro-reflective, accumulation,  
2 ft. zone length, without valve

## Wiring Installation

ALL WIRING DIMENSIONS ARE IN MILLIMETERS  
 ALL WIRE ENDS SHOULD BE STRIPPED TO 6.35 MILLIMETERS IN LENGTH

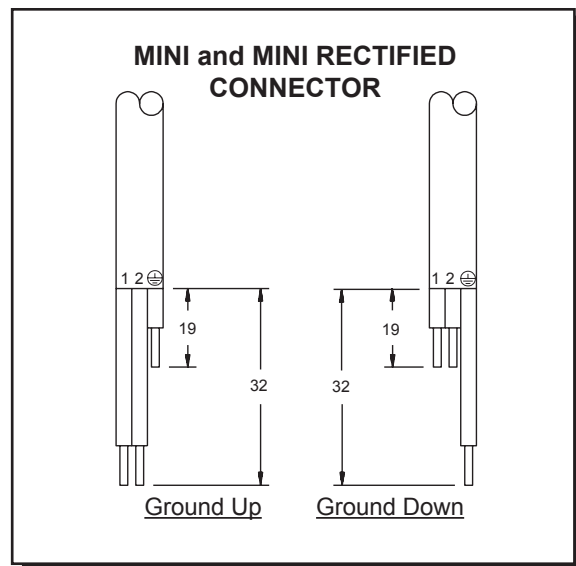
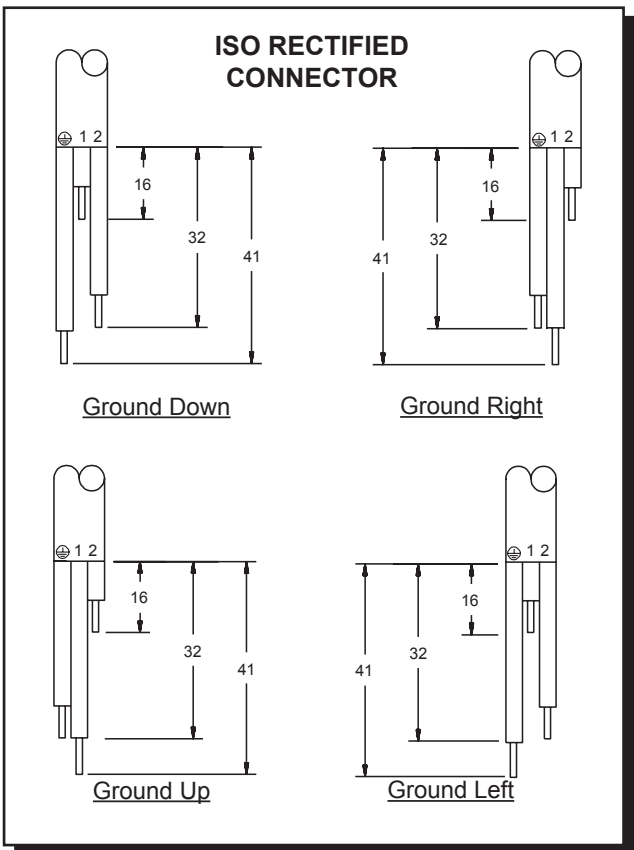
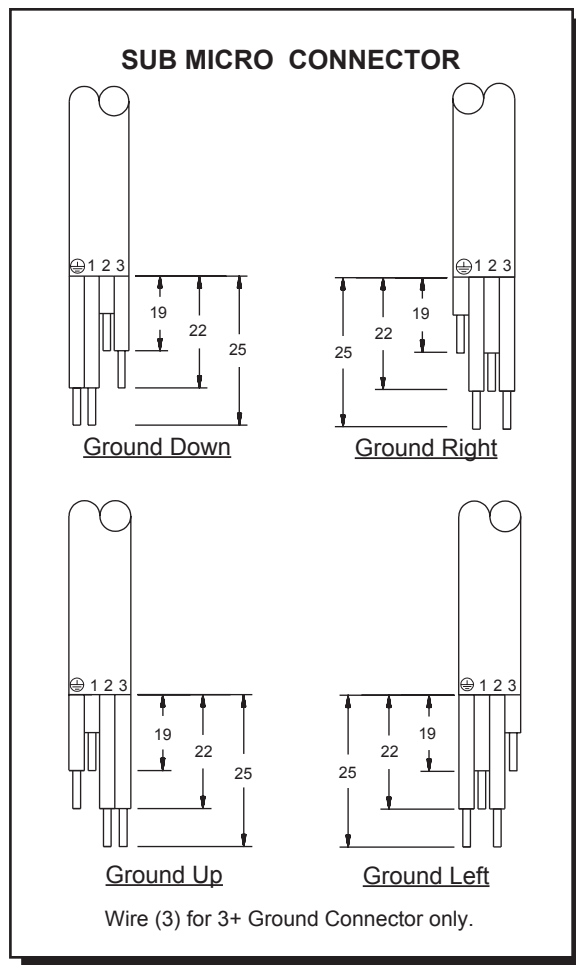
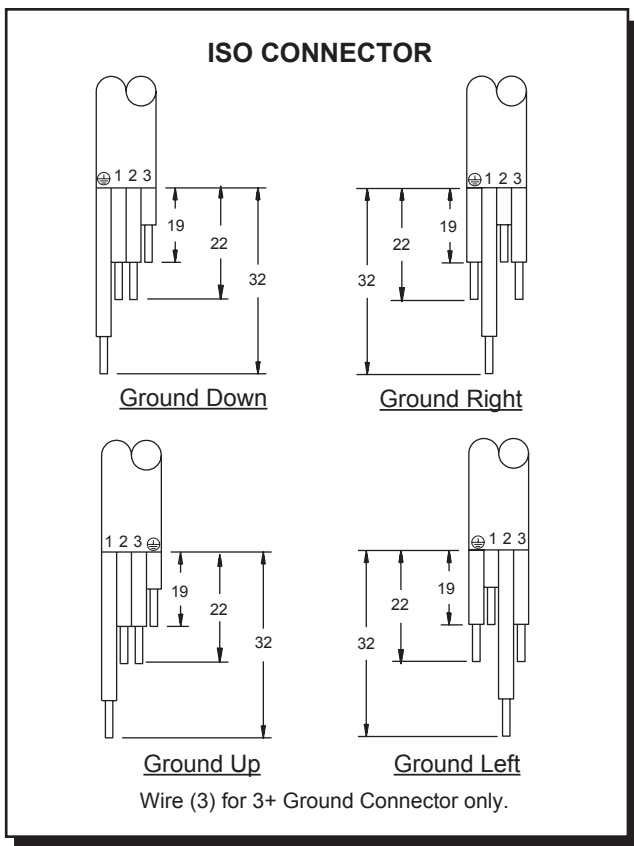

**Flat Wire:**

**SPT** - Stranded, Parallel, Thermoplastic

This is always followed by a -1, -2 or -3, signifying insulation thickness for different applications.

**HPN** - Heater, Parallel, Neoprene

Required for heater-type applications, such as irons, toasters, etc.

**Note:** We can run some 20 AWG, but mostly we run 18, 16 and 14 AWG, 2 or 3 conductors.

P is always Parallel Wire (Flat).

**Jacketed Wire:**

**S** - Stranded (or Service Wire)

**J** - Junior Service (300 Volt). If no "J" is in the wire type, then it is a hard service (600 Volt).

**T** - Thermoplastic. If no "T" is in the wire type, then it has a rubber jacket.

**O** - Oil-Resistant Compound

**W** - Weather-Resistant Compound

**V** - Vacuum - as in vacuum cleaner. This is a small O.D. Jacketed wire, very flexible and initially used for vacuum cleaners but now used on many different types of products. Available only in 18 AWG.

**Examples:**

**SV** - Stranded Vacuum Rubber Jacketed (NO "T")

**SJT** - Stranded Junior Thermoplastic

**SJTOW** - Stranded Junior Thermoplastic, Oil and Weather resistant for UL and CSA.

**Inner Conductor Colors**

Function	North American (NA)	International (ICC)
Hot	Black	Brown
Neutral	White	Blue
Earth (Ground)	Green	Green w/ Yellow Stripe

Volts =  $\sqrt{\text{Watts} \times \text{Ohms}}$   
 Volts =  $\frac{\text{Watts}}{\text{Amperes}}$   
 Volts = Amperes x Ohms

Amperes =  $\sqrt{\frac{\text{Watts}}{\text{Ohms}}}$   
 Amperes =  $\frac{\text{Watts}}{\text{Volts}}$   
 Amperes =  $\frac{\text{Volts}}{\text{Ohms}}$

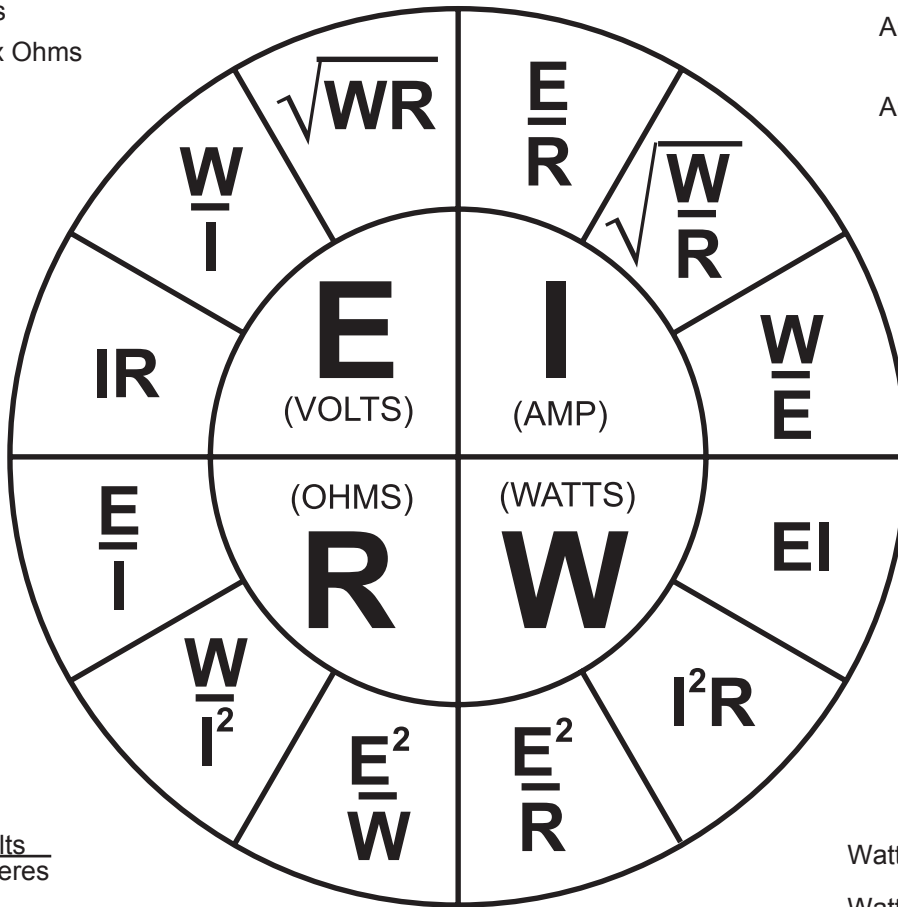

Ohms =  $\frac{\text{Volts}}{\text{Amperes}}$   
 Ohms =  $\frac{\text{Volts}^2}{\text{Watts}}$   
 Ohms =  $\frac{\text{Watts}}{\text{Amperes}^2}$

Watts =  $\frac{\text{Volts}^2}{\text{Ohms}}$   
 Watts = Amperes<sup>2</sup> x Ohms  
 Watts = Volts x Amperes



<b>INDEX OF PROTECTION (IP) RATINGS</b> (International Electrotechnical Commission Index of Protection)	<b>NEMA STANDARDS</b> (National Electrical Manufacturers Association)
<b>PROTECTION AGAINST SOLID OBJECTS - FIRST DIGIT</b>	<b>ENCLOSURE TYPES FOR NON-HAZARDOUS LOCATIONS</b>
<p> <b>0</b> No Protection  <b>1</b> Protected from solid objects up to 50mm (e.g. accidental touch by hands)  <b>2</b> Protected from solid objects up to 12mm (e.g. accidental touch fingers)  <b>3</b> Protected from solid objects larger than 2.5mm (e.g. tools and small wires)  <b>4</b> Protected from solid objects larger than 1mm (e.g. small wires)  <b>5</b> Protected from dust; limited entrance (no harmful deposit)  <b>6</b> Totally protected from dust                 </p>	<p> <b>Type 1 GENERAL PURPOSE</b>                      Enclosures are intended for indoor use primarily to provide a degree of protection against contact with the enclosed equipment or locations where unusual service conditions do not exist.   <b>Type 2 DRIP TIGHT</b>                      Enclosures are intended for indoor use primarily to provide a degree of protection against limited amounts of falling water and dirt.   <b>Type 3 WEATHERPROOF (Weather Resistant)</b>                      Enclosures are intended for outdoor use primarily to provide a degree of protection against wind-blown dust, rain and sleet; undamaged by the formation of ice on the enclosure.                 </p>
<b>PROTECTION AGAINST LIQUIDS - SECOND DIGIT</b>	
<p> <b>0</b> No Protection  <b>1</b> Protected from vertically falling drops of water (e.g. condensation)  <b>2</b> Protected from direct sprays of water up to 15° from vertical  <b>3</b> Protected from direct sprays of water up to 60° from vertical  <b>4</b> Protected from water sprayed from all directions; Limited entrance allowed  <b>5</b> Protected from low pressure jets of water from all directions; limited entrance allowed  <b>6</b> Protected from strong jets of water; limited entrance allowed (e.g. for use on ship decks)  <b>7</b> Protected from the effects of immersion between 15 cm and 1 m for 30 minutes  <b>8</b> Protected from extended periods of immersion under pressure                 </p>	<p> <b>Type 3R RAIN TIGHT</b>                      Enclosures are intended for outdoor use primarily to provide a degree of protection against falling rain and sleet; undamaged by the formation of ice on the enclosure.   <b>Type 4 WATERTIGHT</b>                      Enclosures are intended for indoors and outdoors use primarily to provide a degree of protection against windblown dust and rain, splashing water and hose-directed water; undamaged by the formation of ice on the enclosure.   <b>Type 4X WATERTIGHT</b>                      Enclosures are intended for indoors and outdoors use primarily to provide a degree of protection against corrosion, windblown dust and rain, splashing water and hose-directed water; undamaged by the formation of ice on the enclosure.   <b>Type 5</b> No NEMA equivalent.   <b>Type 6 SUBMERSIBLE</b>                      Enclosures are intended for indoors and outdoors where occasional submersion is encountered.                 </p>
<b>EXAMPLE - IP67</b>	
<p> <b>6</b> Totally protected from dust  <b>7</b> Protected from the effects of immersion between 15 cm and 1 m for 30 minutes                 </p>	<p> <b>Type 12 INDUSTRIAL USE</b>                      Enclosures are intended for indoor and outdoor use primarily to provide a degree of protection against dust falling dirt, and dripping non-corrosive liquids.   <b>Type 13 DUSTPROOF</b>                      Enclosures are intended for indoor and outdoor use primarily to provide a degree of protection against dust spraying of water, oil, and non-corrosive coolant.                 </p>

### Metric to Standard Conversions

Millimeters (mm) x 0.03937	=	inches (") (in)
Centimeters (cm) x 0.3937	=	inches (") (in)
Meters (m) x 39.37	=	inches (") (in)
Meters (m) x 3.281	=	feet (') (ft)
Meters (m) x 1.094	=	yards (yds)
Kilometers (km) x 0.62137	=	miles (mi)
Kilometers (km) x 3280.87	=	feet (') (ft)
Liters (l) x 0.2642	=	gallons (U.S.) (gals)
Liters (l) x 0.0353	=	cubic feet
Bars x 14.5038	=	pounds per square inch (PSI)
Kilograms (kg) x 2.205	=	pounds (P)
Kilometers (km) x 1093.62	=	yards (yds)
Square centimeters x 0.155	=	square inches
Square meters x 10.76	=	square feet
Square kilometers x 0.386	=	square miles
Cubic centimeters x 0.06102	=	cubic inches
Cubic meters x 35.315	=	cubic feet

### Temperature

$$^{\circ}\text{F} = (1.8 \times ^{\circ}\text{C}) + 32$$

$$^{\circ}\text{C} = 0.555 (^{\circ}\text{F} - 32)$$

$$^{\circ}\text{K} = ^{\circ}\text{C} + 273.2$$

Fahrenheit	Celsius	Rankine	Kelvin
602	316.7	1061.7	589.9
572	300.0	1031.7	573.2
542	283.3	1001.7	556.5
512	266.7	971.7	539.9
482	250.0	941.7	523.2
452	233.3	911.7	506.5
422	216.7	881.7	489.9
392	200.0	851.7	473.2
362	183.3	821.7	456.5
332	166.7	791.7	439.9
302	150.0	761.7	423.2
272	133.3	731.7	406.5
242	116.7	701.7	389.9
212	100.0	671.7	373.2
182	83.3	641.7	356.5
152	66.7	611.7	339.9
122	50.0	581.7	323.2
92	33.3	551.7	306.5
62	16.7	521.7	289.9
32	0.0	491.7	273.2
2	-16.7	461.7	256.5
-28	-33.3	431.7	239.9
-58	-50.0	401.7	223.2
-88	-66.7	371.7	206.5
-118	-83.3	341.7	189.9
-148	-100.0	311.7	173.2
-178	-116.7	281.7	156.5
-208	-133.3	251.7	139.9
-238	-150.0	221.7	123.2
-268	-166.7	191.7	106.5
-298	-183.3	161.7	89.9
-328	-200.0	131.7	73.2
-358	-216.7	101.7	56.5
-388	-233.3	71.7	39.9
-418	-250.0	41.7	23.2
-459.7	-273.2	0.0	0.0

**AC** - Acronym for Alternating Current.

**AMP (A)** - Abbreviation of Ampere, a unit of measure for electrical current

**AWG - American Wire Gage** is a numerical standard used to refer to the diameter cross sectional area of a wire. Smaller numbers refer to larger cross sectional areas.

**Bridge Rectifier** - This is an electrical device made up of four diodes, which perform the function of full wave rectification (converts the full AC sine wave to DC).

**Capacitor** - This is an electronic device used to store an electric charge or to allow varying current to flow. The ideal capacitor will not allow steady state or DC current to flow. The capacitor is used in many applications including transient suppression, electrical noise filtering, timing circuits, etc.

**Conductor** - This is a material that can easily conduct (flow) electrical current. Metals are considered to be good conductors of electricity.

**Current Surge** - This is a short term (transient) condition causing a larger than normal amount of current to flow through a conductor. A current surge can often cause damage to an electrical device that is not properly protected.

**DC** - Acronym for Direct Current.

**DIN** - This is an acronym used for the Deutsches Institut fur Normung (German Standardization Institute).

**DIN 43650** - A German standard stating the characteristics and requirements of connectors for magnetic valves used in hydraulics and pneumatics.

**Diode** - This is a solid state electronic component that allows current to flow in only one direction, similar to a check valve used in hydraulic or pneumatic applications. The diode is used in applications including transient suppression, power supply circuits etc.

**Electronic Magnetic Sensor** - This is a solid state device used to sense a magnetic field. Canfield Connector uses magneto-resistive sensors on all electronic magnetic sensors.

**Gauss (Ga)** - Unit of measure for magnetic flux density.

**Ground** - This term is used to define an electrical connection normally common to the chassis of a device or earth ground.

**Hertz (Hz)** - The unit of measure for frequency in cycles per second.

**IP65** - An environmental protection rating of enclosures according to the German Standard DIN 40050.

**ISO** - This is an acronym used for the International Standards Organization.

**LED** - An acronym for Light Emitting Diode. A solid state diode which emits light when current passes through it in the proper direction.

**MOV** - An acronym for Metal Oxide Varistor. A solid state device used to suppress voltage surges/spikes.

**NEMA** - An acronym for National Electric Manufacturers Association.

**Nitrile (Buna)** - This is a rubber-like man-made material used extensively in gasket and sealing applications.

**Normally Closed** - The state of the output or switch is ON with no external influence.

**Normally Open** - The state of the output or switch is OFF with no external influence.

**NPN (Sinking)** - Acronym used to describe the polarization of bipolar junction transistors (BJTs). Also associated with a sinking output.

**Opto-Coupled** - Refers to a technique used to optically activate (turn on) an electronic device, usually a transistor or triac, and physically separate two sides of a circuit. This action is similar to a solenoid relay. The typical opto-coupler incorporates an LED (light emitting diode) as the actuating device.

**Parallel Magnet Polarity** - The term used to describe the polar orientation of the piston magnet with respect to the cylinder stroke. In this case, the north and south poles are oriented in the same direction parallel to the cylinder stroke.

**Perpendicular Magnet Polarity** - The term used to describe the polar orientation of the piston magnet with respect to the cylinder stroke. In this case, the north and south poles are oriented perpendicular to the cylinder stroke.

**PNP (Sourcing)** - Acronym used to describe the polarization of bipolar junction transistors (BJTs). Also associated with a sourcing output.

**Rectification** - This is a term used to describe an electrical process which converts AC (alternating current) to DC (direct current).

**Reed Switch** - This is a miniature mechanical switch that changes state when a magnetic field is applied.

**Resistor** - This is an electronic device that resists the flow of current. Higher resistor Ohm values offer more resistance to the flow of current.

**Silicone** - This is a rubber-like man-made material used extensively in gasket and sealing applications. It is very resistant to a wide range of chemicals including oils and solvents, and has a very wide temperature range.

**Sinking** - The term is used here to describe the way a switch is connected in the circuit. If the switch completes the electrical circuit by connecting the load to ground/(-), it is considered to be sinking the load. In a solid state device this is equivalent to a NPN output.

**Solid State** - This is a term often used to describe an electronic device made up of solid components (no moving parts).

**Sourcing** - The term is used here to describe the way a switch is connected in the circuit. If the switch completes the electrical circuit by connecting the load to the positive/(+), it is considered to be sourcing the load. In a solid state device this is equivalent to a PNP output.

**SPST** - Acronym used for **Single Pole Single Throw** switches.

**SPDT** - Acronym used for **Single Pole Double Throw** switches.

**Transistor** - This is a solid state device used in electronic circuits. It is often used in switching or amplifier applications.

**Triac** - This is a solid state device often used to switch AC voltage/current.

**Volt (V)** - The unit of measure for electrical potential.

**Voltage Spike** - This is a short term (transient) condition causing a larger than normal amount of voltage to be applied to a circuit. Voltage spikes can often cause damage to an electric device that is not properly protected.

**Watt (W)** - The unit of measure for electrical power.



