

NSHD CONNECTOR

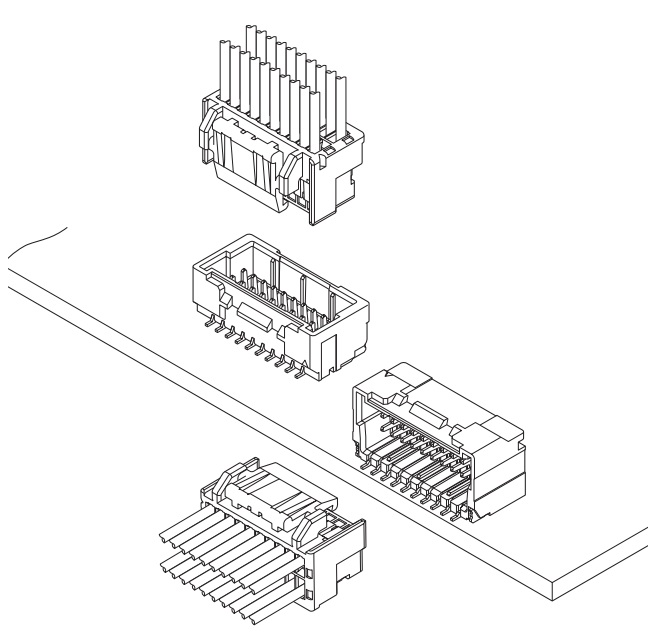

1.0mm pitch/Disconnectable Crimp style connectors



In 1.0 mm pitch and dual-row secure lock type connector, this NSHD connector realizes a top grade of a space saving in the industry and supports a high densification of equipment.

- **Excellent mounting and dismounting workability of socket**
- **Adopting large lock in consideration of unlocking and withstanding external force**
- **Various lineups of circuits**
- **An existing crimping applicator is available.**

Specifications

- Current rating: 1.0 A AC, DC (AWG #28)
- Voltage rating: 50 V AC, DC
- Temperature range: -25°C to +85°C
(including temperature rise in applying electrical current)
- Contact resistance: Initial value/ 20 mΩ max.
After environmental tests/ 40 mΩ max.
- Insulation resistance: 100 MΩ min.
- Withstanding voltage: 500 VAC/minute
- Applicable wire: Conductor size/ AWG #32 to #28
Insulation O.D./ 0.4 to 0.8 mm

* Refer to "General Instruction and Notice when using Terminals and Connectors" at the end of this catalog.

* Contact JST for details.

* Compliant with RoHS.

PC board layout and Assembly layout

Top entry type

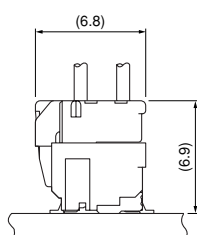
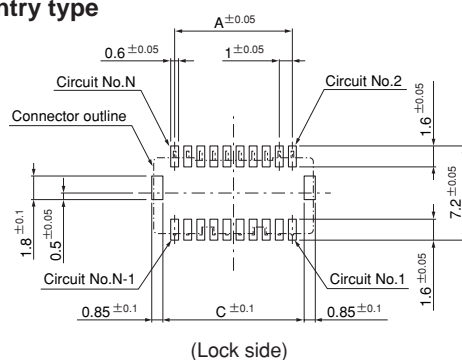

Side entry type

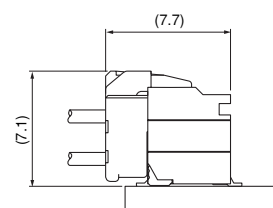
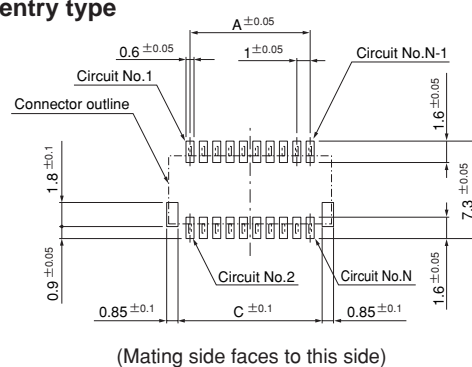

Note: 1. The above figure is the figure viewed from the connector mounting side.

2. Tolerances are non-cumulative: ± 0.05 mm for all centers. The dimensions above should serve as a guideline. Contact JST for details.

NSHD CONNECTOR

Contact

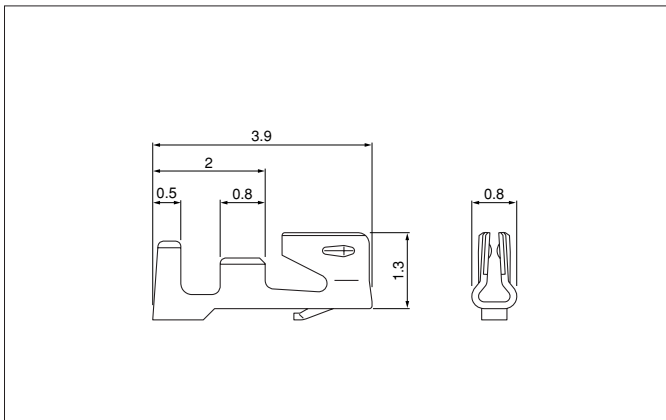

Model No.	Applicable wire		Insulation O.D. (mm)	Q'ty/reel
	mm ²	AWG#		
SNSHD-003T-P0.2	0.032~0.08	32~28	0.4~0.8	23,000

Material and Finish

Copper alloy, tin-plated (reflow treatment)

RoHS compliance

Contact	Crimping machine	Applicator		
		Crimp applicator	Dies	Crimp applicator with dies
SNSHD-003T-P0.2	AP-K2N	MKS-L-10-3	MK/SSH/L-003-02	APLMK SSH/L003-02
		*MKS-SC	SC/SSH/L-003-02	APLSC SSH/L003-02

Note: *Strip-crimp applicator

Contact JST for applicable wires in case that it is not usable due to wire size.

Housing

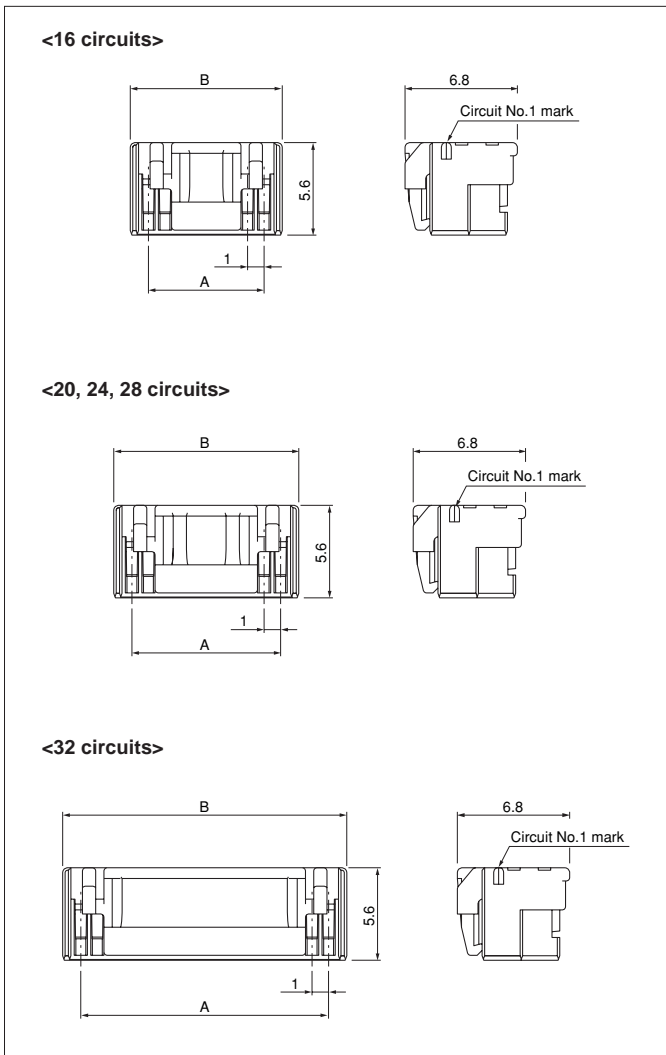

Circuits	Model No.	Dimensions (mm)		Q'ty/bag
		A	B	
16	NSHDR-16V-Z	7.0	9.2	2,500
20	NSHDR-20V-Z	9.0	11.2	2,000
24	NSHDR-24V-Z	11.0	13.2	1,500
28	NSHDR-28V-Z	13.0	15.2	1,000
32	NSHDR-32V-1-Z	15.0	17.2	1,000

Material

PBT, UL94V-0, ivory

RoHS compliance

<For reference> As the color identification,

the following alphabet shall be put in the underlined part.

For availability, delivery and minimum order quantity, contact JST.

ex. **NSHDR-16V-Z**

Z...ivory TR...tomato red E...blue MG...moss green

DPK...dark pink

NSHD CONNECTOR

Shrouded header

Top entry type

<16 circuits>

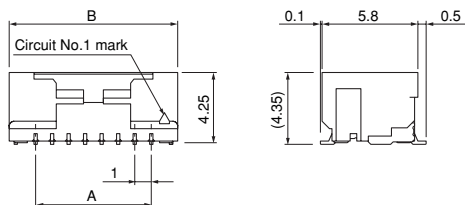

<20, 24, 28 circuits>

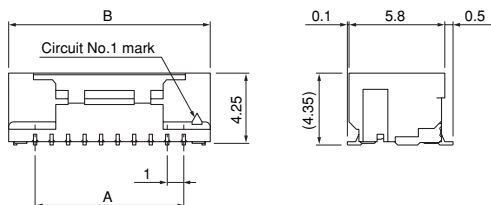

<32 circuits>

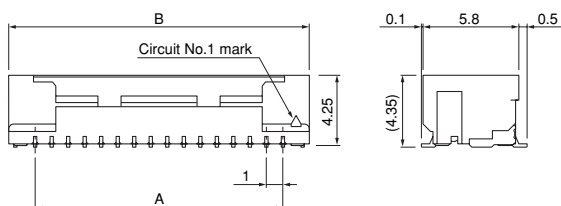

Side entry type

<16 circuits>

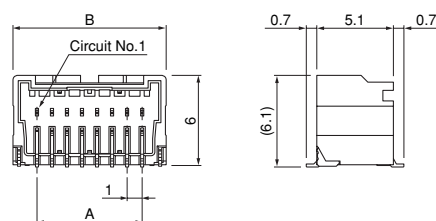

<20, 24, 28 circuits>

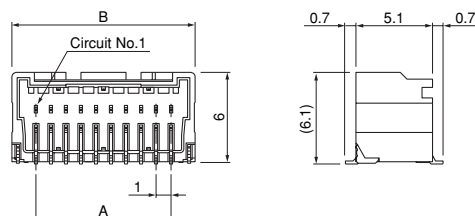

<32 circuits>

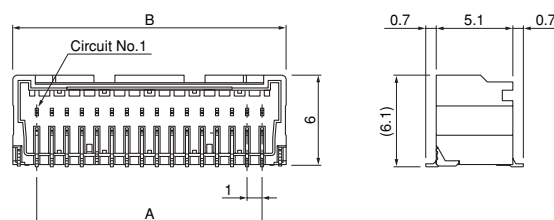

Top entry type

Circuits	Model No.	Dimensions (mm)			Q'ty/ reel
		A	B	C	
16	BM16B-NSHDZS-TFT	7.0	10.2	8.8	1,600
20	BM20B-NSHDZS-TFT	9.0	12.2	10.8	1,600
24	BM24B-NSHDZS-TFT	11.0	14.2	12.8	1,600
28	BM28B-NSHDZS-TFT	13.0	16.2	14.8	1,600
32	BM32B-NSHDZS-1-TFT	15.0	18.2	16.8	1,600

Material and Finish

Contact: Copper alloy, copper-undercoated, tin-plated (reflow treatment)
Header: Polyamide resin, UL94V-0, ivory
Reinforcing tab: Copper alloy, copper-undercoated, tin-plated (reflow treatment)

RoHS compliance

Note: These products listed above are supplied on embossed-tape.

<For reference> As the color identification, the following alphabet shall be put in the underlined part.
For availability, delivery and minimum order quantity, contact JST.

ex. **BM16B-NSHDZS-TFT**
Z...ivory TR...tomato red E...blue MG...moss green
DPK...dark pink

Side entry type

Circuits	Model No.	Dimensions (mm)			Q'ty/ reel
		A	B	C	
16	SM16B-NSHDZS-TF	7.0	10.2	8.8	1,000
20	SM20B-NSHDZS-TF	9.0	12.2	10.8	1,000
24	SM24B-NSHDZS-TF	11.0	14.2	12.8	1,000
28	SM28B-NSHDZS-TF	13.0	16.2	14.8	1,000
32	SM32B-NSHDZS-1-TF	15.0	18.2	16.8	1,000

Material and Finish

Contact: Copper alloy, copper-undercoated, tin-plated (reflow treatment)
Header: Polyamide resin, UL94V-0, ivory
Reinforcing tab: Copper alloy, copper-undercoated, tin-plated (reflow treatment)

RoHS compliance

Note: These products listed above are supplied on embossed-tape.

<For reference> As the color identification, the following alphabet shall be put in the underlined part.
For availability, delivery and minimum order quantity, contact JST.

ex. **SM16B-NSHDZS-TF**
Z...ivory TR...tomato red E...blue MG...moss green
DPK...dark pink