

BATTERY PROBE

Battery Probes are typically contained in modules where consistent, long-life, low-resistance, compliant electrical and mechanical connections are required. Battery Probes offer superior durability in high cycle life application compared to leaf spring applications. Pogo based solutions can maintain consistent electro-mechanical characteristics in excess of mission cycles. When mating planar tolerances pose a challenge or a longer reach is required, spring probes are the preferred solution.

They are typically molded into a housing and soldered either to mating PCB or terminal to provide a permanent stable and reliable electrical and mechanical connection.

Everett Charles Technologies versatile line of battery interconnect probes gives you design flexibility to match your performance, cost, and assembly requirements. Our design expertise and complete manufacturing capabilities will help you bring your product to market faster and easier. As part of our customer service commitment, these products can be modified or custom designed to meet your needs. Contact us to discuss the limitless possibilities.



BIP-1 BIP-3

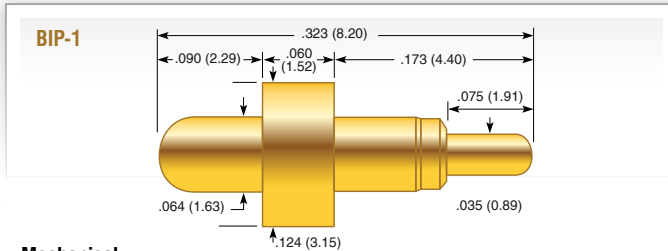

Mechanical

Recommended Travel: .050 (1.27)
 Full Travel: .075 (1.91)
 Operating Temperature: -55°C to +150°C

Spring Force in oz. (grams)

	Preload	Rec. Travel
Standard	1.18 (33)	3.25 (92)

Electrical (Static Conditions)

Current Rating: 5 amps
 Average Probe Resistance: <16 mOhms

Materials and Finishes

Plunger: BeCu, Gold plated over hard Nickel
 Barrel: Brass, Gold plated over hard Nickel
 Spring: Stainless Steel, Silver plated

BIP-2 BIP-8

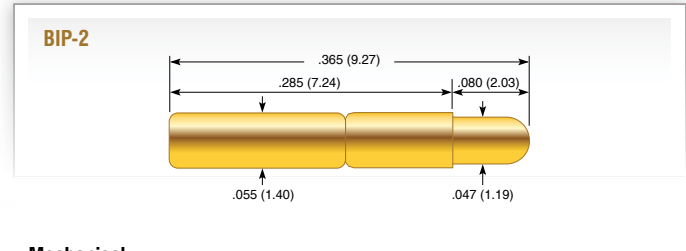

Mechanical

Recommended Travel: .050 (1.27)
 Full Travel: .050 (1.27)
 Operating Temperature: -55°C to +150°C

Spring Force in oz. (grams)

	Preload	Rec. Travel
Standard	1.10 (31)	3.85 (109)

Electrical (Static Conditions)

Current Rating: 5 amps
 Average Probe Resistance: <30 mOhms

Materials and Finishes

Plunger: Heat-treated BeCu, Gold plated over hard Nickel
 Barrel: Work-hardened Nickel Silver, Gold plated over hard Nickel
 Spring: Stainless Steel, Silver plated

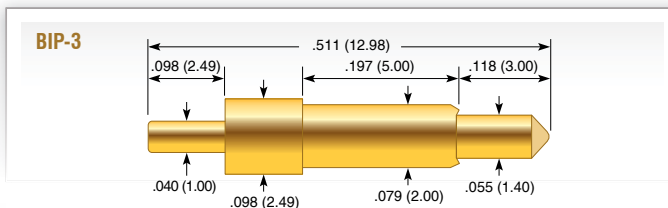

Mechanical

Recommended Travel: .060 (1.52)
 Full Travel: .100 (2.54)
 Operating Temperature: -55°C to +105°C

Spring Force in oz. (grams)

	Order Code	Preload	Rec. Travel
Standard		0.30 (8.5)	1.06 (30)
Alternate	-1	1.1 (31)	3.40 (86)

Electrical (Static Conditions)

Current Rating: 5 amps
 Average Probe Resistance: <30 mOhms

Materials and Finishes

Plunger: Brass, Gold plated over hard Nickel
 Barrel: Brass, Gold plated over hard Nickel
 Spring: Music Wire, Silver plated

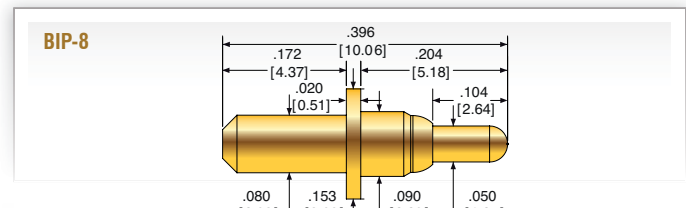

Mechanical

Recommended Travel: .060 (1.52)
 Full Travel: .090 (2.29)
 Operating Temperature: -55°C to +150°C

Spring Force in oz. (grams)

	Preload	Rec. Travel
Standard	2.40 (68.0)	6.20 (176)

Electrical (Static Conditions)

Current Rating: 5 amps
 Average Probe Resistance: <30 mOhms

Materials and Finishes

Plunger: BeCu, Gold plated
 Barrel: BeCu, Gold plated
 Spring: Stainless Steel
 Ball: Stainless Steel

BIP-10

BIP-12

BIP-10

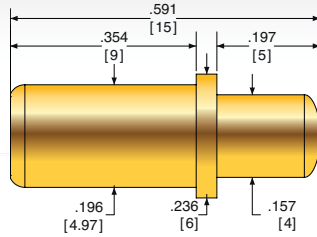

Mechanical

Recommended Travel:	.126 (3.20)
Full Travel:	.157 (4.00)
Operating Temperature:	-40°C to +80°C

Spring Force in oz. (grams)

	Preload	Rec. Travel
Standard	1.00 (28.3)	5.40 (153)

Electrical (Static Conditions)

Current Rating:	5 amps
Average Probe Resistance:	<30 mOhms, Steel, Gold plated <100 mOhms, Stainless Steel

Materials and Finishes

Plunger:	Brass, Gold plated
Barrel:	Brass, Gold plated
Spring:	Steel, Gold plated or Stainless

BIP-12

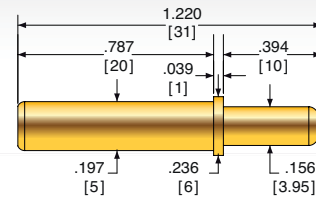

Mechanical

Recommended Travel:	.315 (8.00)
Full Travel:	.374 (10.00)
Operating Temperature:	-40°C to +80°C

Spring Force in oz. (grams)

	Preload	Rec. Travel
Standard	0.87 (24.7)	5.40 (153)

Electrical (Static Conditions)

Current Rating:	5 amps
Average Probe Resistance:	<30 mOhms, Steel, Gold plated <100 mOhms, Stainless Steel

Materials and Finishes

Plunger:	BeCu, Gold plated
Barrel:	Brass, Gold plated
Spring:	Steel, Gold plated or Stainless

CCA-003 CCA-004

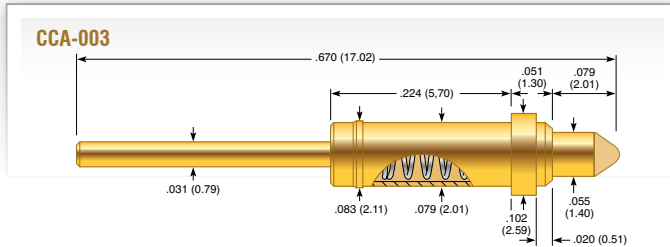

Mechanical

Recommended Travel: .040 (1.02)
 Full Travel: .078 (1.98)
 Operating Temperature: -35°C to +105°C

Spring Force in oz. (grams)

	Preload	Rec. Travel
Standard	1.27 (36)	2.94 (83)

Electrical (Static Conditions)

Current Rating: 10 amps
 Average Probe Resistance: < 50 mOhms

Materials and Finishes

Plunger: Brass, Gold plated
 Barrel: Brass, Gold plated
 Spring: Music Wire, Gold plated

CCA-006

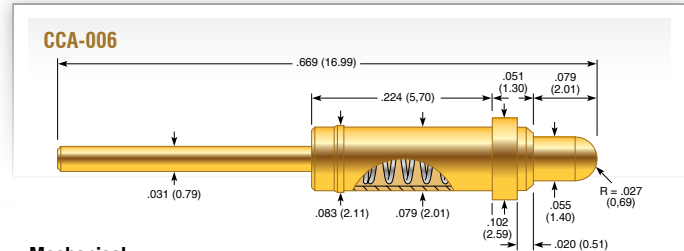

Mechanical

Recommended Travel: .040 (1.02)
 Full Travel: .078 (1.98)
 Operating Temperature: -35°C to +105°C

Spring Force in oz. (grams)

	Preload	Rec. Travel
Standard	1.24 (35)	2.94 (85)

Electrical (Static Conditions)

Current Rating: 5 amps
 Average Probe Resistance: < 50 mOhms

Materials and Finishes

Plunger: Brass, Gold plated
 Barrel: Brass, Gold plated
 Spring: Music Wire, Gold plated

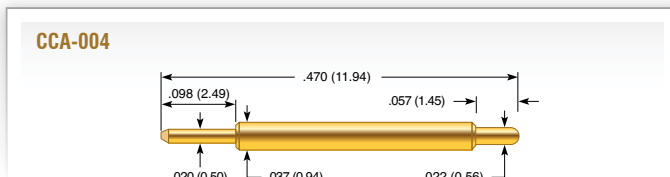

Mechanical

Recommended Travel: .040 (1.02)
 Full Travel: .057 (1.45)
 Operating Temperature: -35°C to +105°C

Spring Force in oz. (grams)

	Preload	Rec. Travel
Standard	0.83 (24)	2.85 (81)

Electrical (Static Conditions)

Current Rating: 10 amps
 Average Probe Resistance: < 50 mOhms

Materials and Finishes

Plunger: Brass, Gold plated
 Barrel: Brass, Gold plated
 Spring: Music Wire, Gold plated

CP-059-019 CP-059-025

CP-059-026

CP-059-019

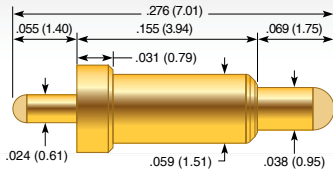

Mechanical

Recommended Travel: .040 (1.02)
 Full Travel: .062 (1.57)
 Operating Temperature: -55°C to +150°C

Spring Force in oz. (grams)

	Preload	Rec. Travel
Standard	1.63 (46)	4.50 (128)

Electrical (Static Conditions)

Current Rating: 10 amps
 Average Probe Resistance: <25 mOhms

Materials and Finishes

Plunger: Brass, Gold plated
 Barrel: Brass, Gold plated
 Spring: Stainless Steel, Gold plated

CP-059-026

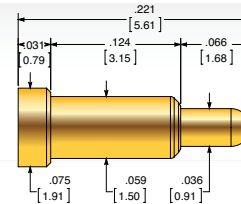

Mechanical

Recommended Travel: .040 (1.02)
 Full Travel: .057 (1.45)
 Operating Temperature: -55°C to +150°C

Spring Force in oz. (grams)

	Preload	Rec. Travel
Standard	0.81 (23.0)	4.50 (128)

Electrical (Static Conditions)

Current Rating: 10 amps
 Average Probe Resistance: <25 mOhms

Materials and Finishes

Plunger: Brass, Gold plated
 Barrel: Brass, Gold plated
 Spring Standard: Stainless Steel, Gold plated

CP-059-025

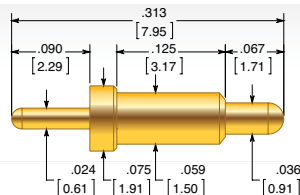

Mechanical

Recommended Travel: .040 (1.02)
 Full Travel: .057 (1.45)
 Operating Temperature: -55°C to +150°C

Spring Force in oz. (grams)

	Preload	Rec. Travel
Standard	0.81 (23.0)	4.50 (128)

Electrical (Static Conditions)

Current Rating: 10 amps
 Average Probe Resistance: <25 mOhms

Materials and Finishes

Plunger: Brass, Gold plated over hard Nickel
 Barrel: Brass, Gold plated over hard Nickel
 Spring: Stainless Steel, Gold plated

Dimensions in inches (millimeters). Specifications subject to change without notice. Consult factory for other temperature requirements, and applications below -40°C. Stocking Disclaimer: Stocking levels for part numbers listed in this catalog are subject to change. Availability is based on current levels of usage and demand.





CP-2

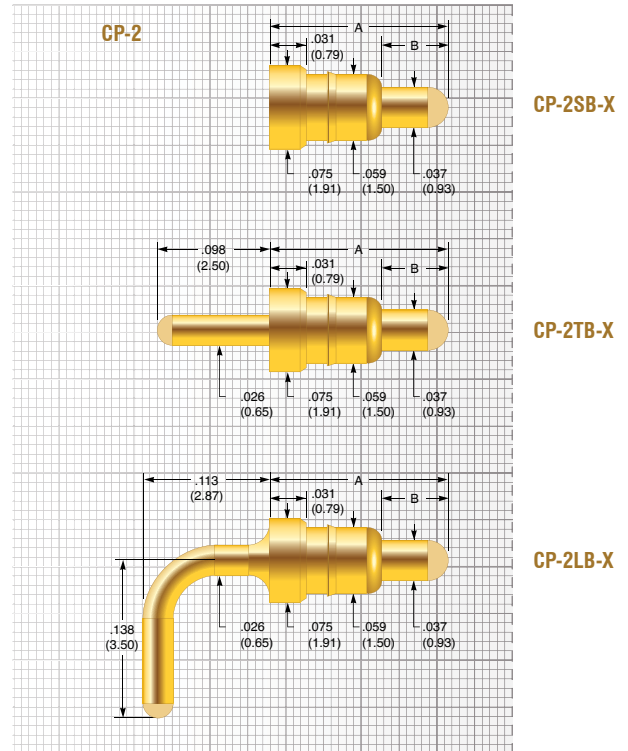

Mechanical

	Size 4	Size 6	Size 8	Size 12
Recommended Travel:	0.030 (0.75)	0.059 (1.50)	0.079 (2.00)	0.118 (3.00)
Full Travel:	0.039 (1.00)	0.069 (1.75)	0.089 (2.25)	0.128 (3.25)
Operating Temperature:	-55°C to +155°C			

Spring Force in oz. (grams)

	Size 4	Size 6	Size 8	Size 12
Preload	0.66 (18.7)	1.32 (37.4)	1.17 (33.3)	0.95 (26.9)
Rec. Travel	4.5 (127.6)	4.5 (127.6)	4.5 (127.6)	4.5 (127.6)

Mechanical

Dimension A	0.158 (4.00)	0.236 (6.00)	0.315 (8.00)	0.472 (12.00)
Dimension B	0.059 (1.50)	0.087 (2.20)	0.114 (2.90)	0.169 (4.30)

Electrical (Static Conditions)

Current Rating	5 A
Average Probe Resistance	50 mOhms

Materials and Finishes

Plunger:	BeCu, Gold plated
Barrel:	Brass, Gold plated
Spring:	Stainless Steel

CP-4

Mechanical

Recommended Travel:	.040 (1.01)
Full Travel:	.060 (1.52)
Operating Temperature:	-55°C to +150°C

Spring Force in oz. (grams)

	Preload	Rec. Travel
Standard	0.49 (13.89)	2.50 (70.87)

Electrical (Static Conditions)

Current Rating:	10 amps
Average Probe Resistance:	<25 mOhms

Materials and Finishes

Plunger:	BeCu, Gold plated
Barrel:	Brass, Gold plated
Spring:	Stainless Steel, Gold plated
Ball:	Stainless Steel

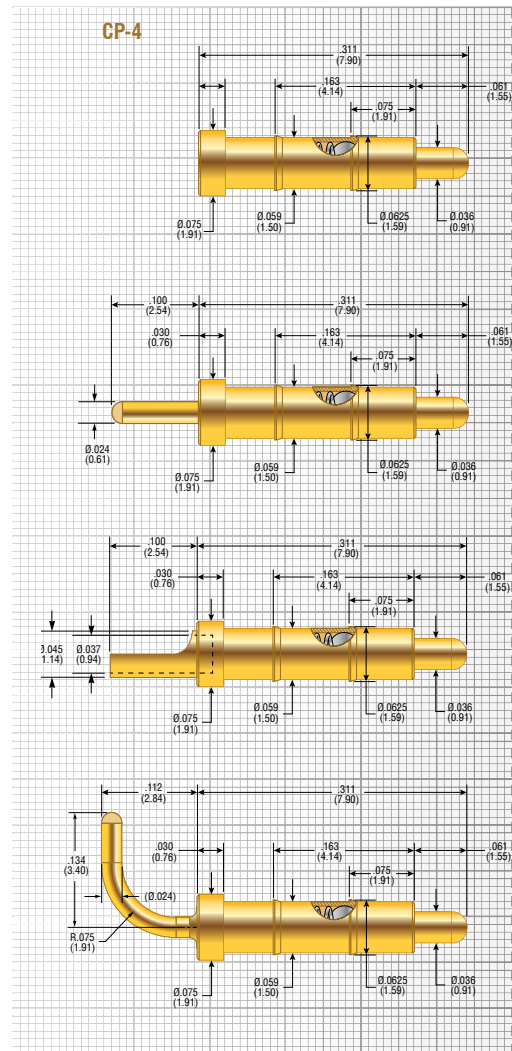

CP-4S

CP-4T

CP-4C

CP-4L