

RF & Microwave Amplifiers

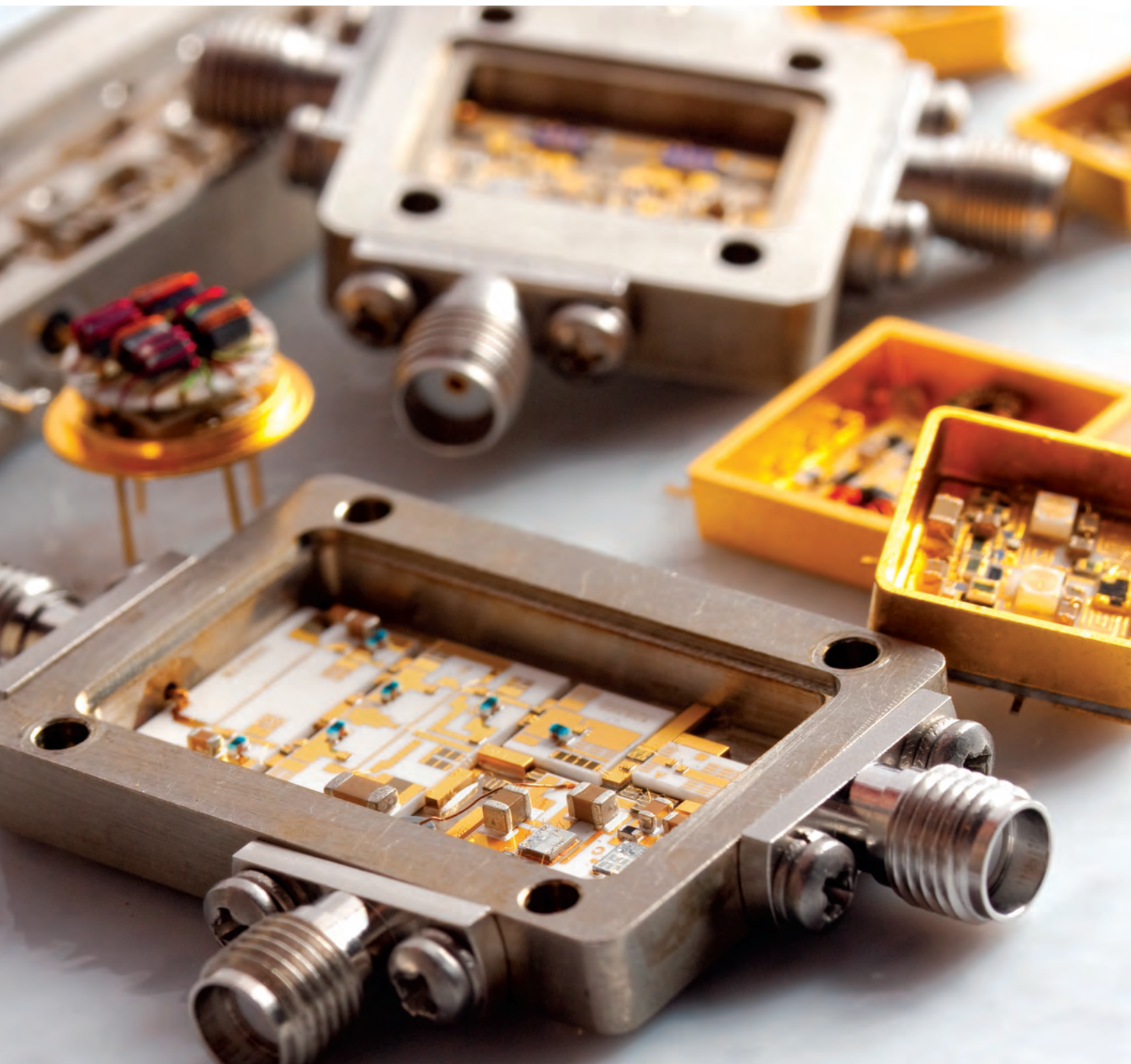

API Technologies, a world class leader in amplifier technology, is your full service partner for high performance amplification requirements.

Following the successful heritage firms of Amplifonix and Q-bit, API Technologies continues to broaden its technology base through higher frequency designs, higher power models, lower cost selections, and lower phase noise amplifiers. Our talented group of engineers have crafted a selection of amplifiers that meets and exceeds their customers' expectations, and continues to build upon that excellent reputation.

API's amplification expertise covers multiple disciplines including:

- Low Phase Noise Amps
- High Frequency Amps
- Low Noise Amps
- High Linearity Amps
- High Reverse Isolation Amps
- Filtered GPS LNAs
- Higher Power Amps
- Custom Amps

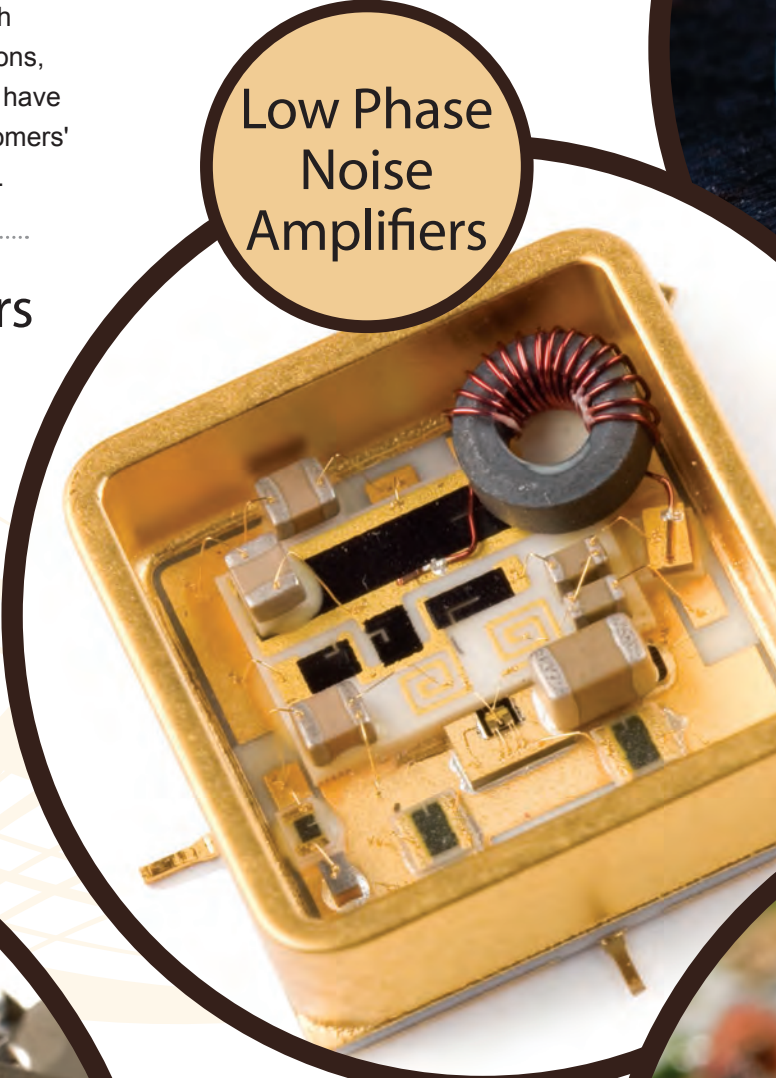

Low Phase
Noise
Amplifiers



Higher
Power
Amplifiers



Filtered
GPS LNAs



Custom
Amplifier
Designs



Higher
Volume
Package
Options



High
Linearity
Amplifiers

Wide Variety

API Technologies offers a variety of package options for its Amplifier line including our Higher Volume Packages (non-hermetic) surface-mount package. This package option not only helps keep costs down, but on higher power requirements the transistor is bonded right to the CuMo heat spreader for cooler operating temperatures.

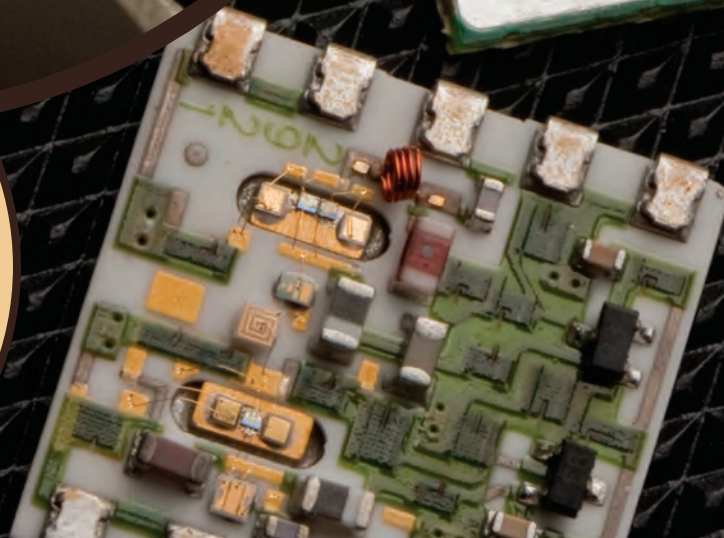
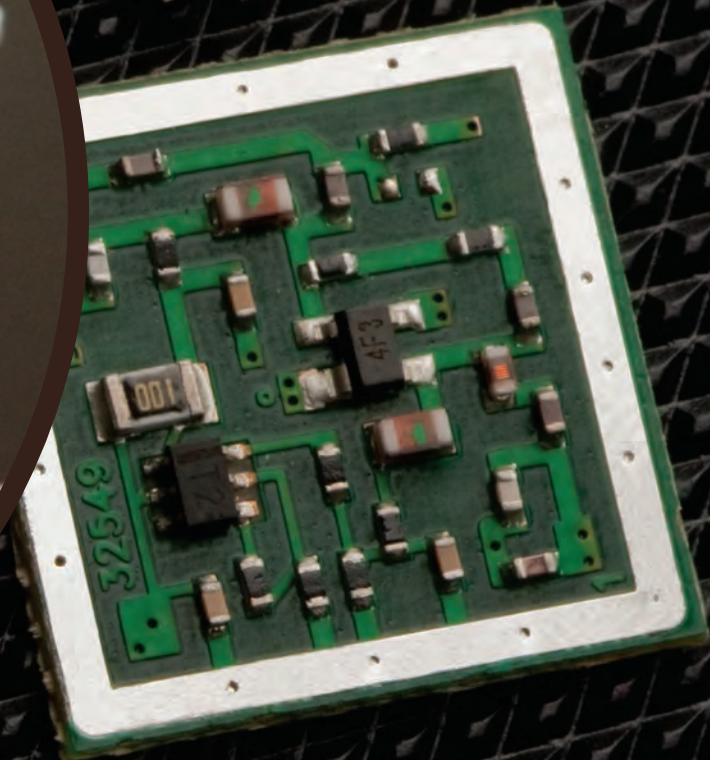
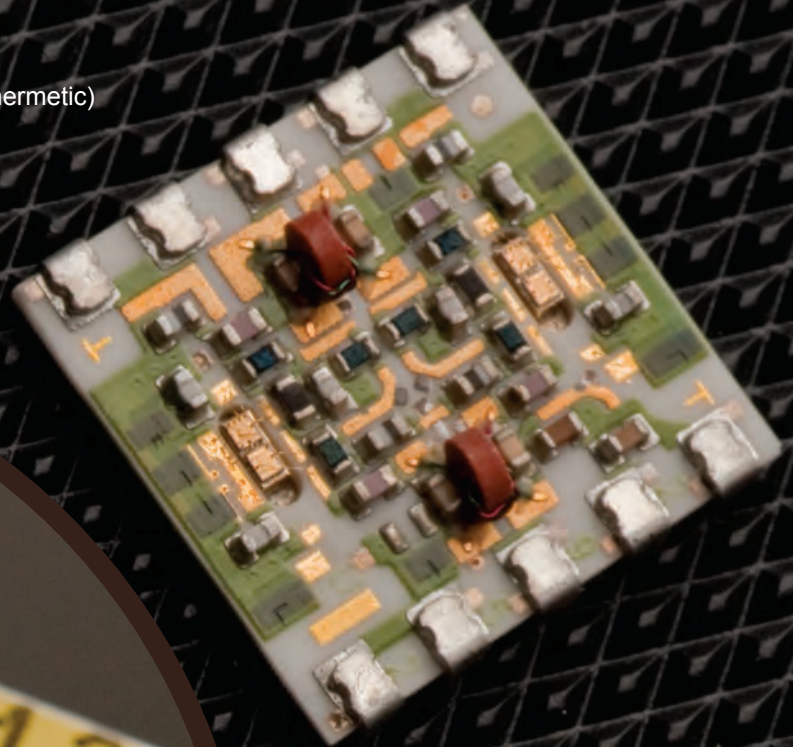
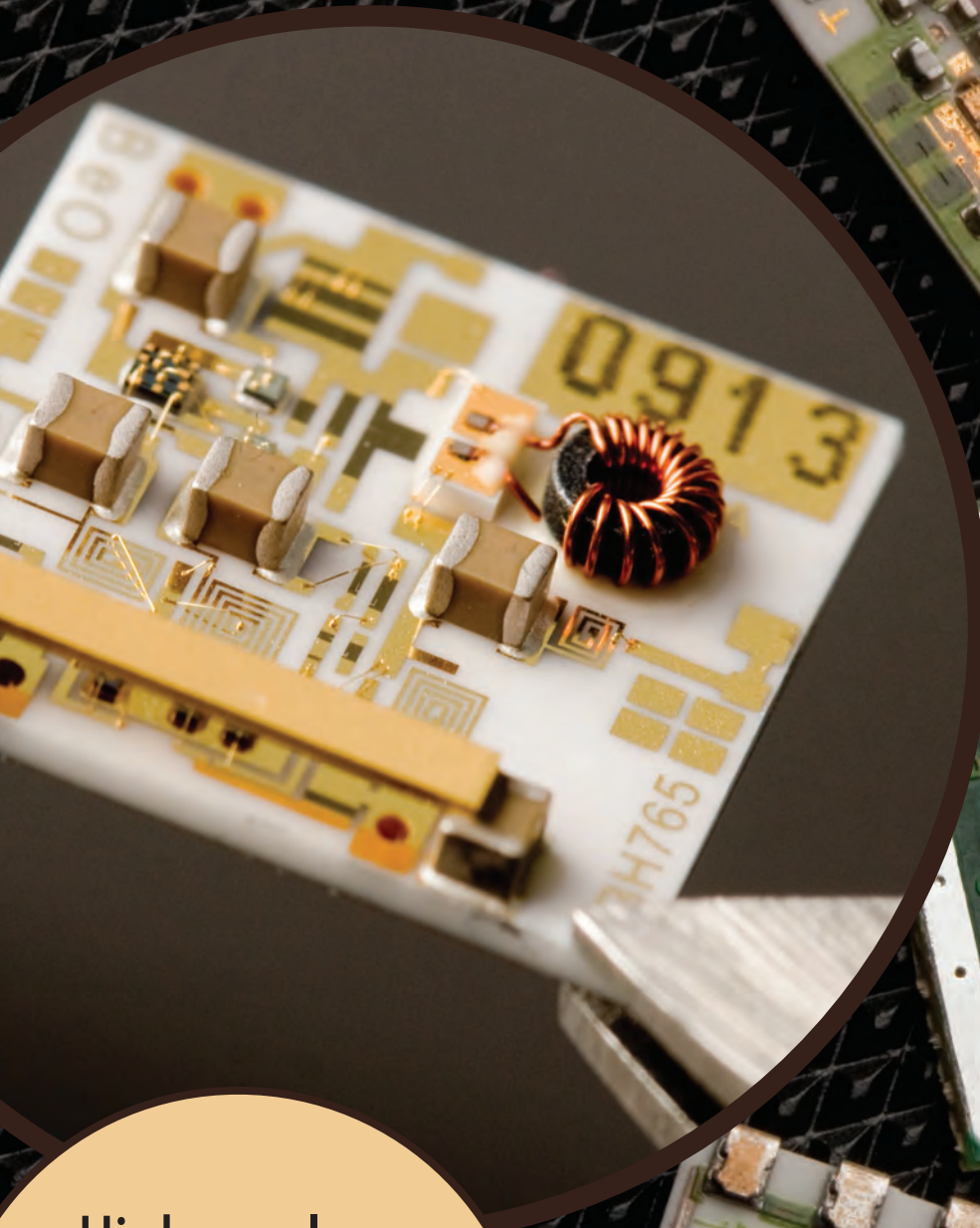

Higher volume packaged amplifiers can cut your costs by as much as 75%!

Lower Cost Package Options

When your amplifier requirements are for 100 units or more, we offer cost effective package options that combine savings and high performance in one product. API has a large selection of both standard and custom higher volume designs, offering both exceptional value and outstanding performance.

Guaranteed High Performance in a Lower Cost Package

- ✓ Custom frequencies to 4000 MHz
- ✓ Output Power to 2 watts
- ✓ Noise figures as low as 0.9 dB
- ✓ No external biasing or RF matching circuits needed
- ✓ Available in tape and reel
- ✓ Perfect drop-in gain solution for Integrated Assemblies

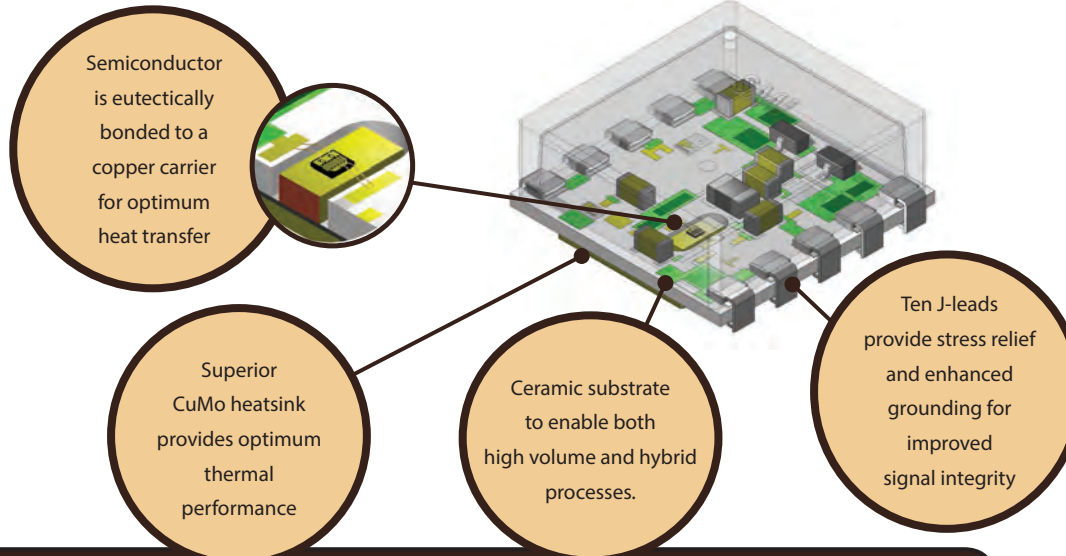

Lower Cost Amplifier Guide

Part Number	Frequency (MHz)	Gain (dB)	P1dB (dBm)	Noise Figure (dB)	IP3 Two-Tone (dBm)	IP2 Two-Tone (dBm)	Rev. Iso. (dB)	Input VSWR	Output VSWR	DC Power (Volts/mA)
QBH-8980	30 - 110	8.2	15	1.3	33	48	11	1.3	1.3	5 V / 25 mA
QBH-8719	30 - 145	21.5	25	2.5	40	51	32	1.2	1.2	15 V / 105 mA
QBH-8171	10 - 150	14	27	6.5	40	50	23	1.5	1.6	15 V / 105 mA
QBH-8137	10 - 200	12.7	21	4.0	38	48	25	1.5	1.5	15 V / 94 mA
QBH-8749	10 - 200	22	26	3.5	40	57	45	1.4	1.4	12 V / 200 mA
QBH-8981	10 - 250	8	21	1.9	40	55	11	1.4	1.2	15 V / 28 mA
QBH-8152	10 - 300	17	18	3.5	33	43	24	1.7	1.7	15 V / 68 mA
QBH-8769	1.5 - 400	16	13	2.1	29	38	26	1.5	1.5	5 V / 45 mA
QBH-8126	5 - 400	15.2	16	3.8	30	38	24	1.5	1.5	15 V / 50 mA
QBH-8114	10 - 400	14.4	7	3.0	20	30	26	1.5	1.5	5 V / 25 mA
QBH-8510	30 - 400	17	12	1.4	25	34	25	1.2	1.2	5 V / 30 mA
QBH-8115	10 - 500	12.3	26	7.8	35	42	23	1.5	1.5	15 V / 165 mA
QBH-8714	800 - 825	16	27	1.1	41	51	21	1.5	1.6	15 V / 150 mA
QBH-8720	824 - 849	24.5	23	1.2	36	46	40	1.4	1.4	15 V / 140 mA
QBH-8919	800 - 900	8.5	24	3.5	40.5	48	13	1.5	1.5	15 V / 150 mA
QBH-8713	890 - 915	15.8	27	1.0	42	52	21	1.5	1.6	15 V / 150 mA
QBH-8904	850 - 950	14.5	24.5	1.2	37	44	20	1.4	1.3	15 V / 85 mA
QBH-8708	800 - 960	12.8	24	2.2	38	47	18	1.3	1.3	15 V / 160 mA
QBH-8920	800 - 960	17.5	29	2.5	45	55	22	1.3	1.3	9 V / 330 mA
QBH-8900	800 - 960	22	32	1.8	48	56	42	1.5	1.5	15 V / 30 mA
QBH-8817	10 - 1500	13.5	20	5.0	32	40	13	1.5	1.5	15 V / 102 mA
QBH-8739	1217 - 1585	22	5	0.9	15	24	45	1.5	1.5	5 V / 43 mA
QBH-8756	1850 - 1910	22.5	20	1.0	35	45	40	1.5	1.5	15 V / 210 mA
QBH-8762	1850 - 1910	26.8	24	1.0	37	47	45	1.4	1.4	15 V / 210 mA
QBH-8702	1850 - 1910	28	25	1.2	37	47	44	1.5	1.5	12 V / 190 mA
QBH-8709	1930 - 1990	16	18.5	1.5	30	40	26	1.4	1.4	12 V / 85 mA
QBH-8701	1930 - 1990	28	25	1.2	37	47	40	1.5	1.5	12 V / 190 mA
QBH-8872	30 - 2000	10	27.5	5.2	41	47	18	1.9	1.9	15 V / 410 mA
QBH-8911	50 - 2000	10	25	4.5	41	48	20	1.7	1.5	12 V / 220 mA
QBH-8407	50 - 2000	10	28	4.5	42	50	20	1.7	1.5	15 V / 220 mA
QBH-8990	450 - 2500	15	23	2.7	36	55	25	1.6	1.5	15 V / 160 mA
QBH-8916	1800 - 2500	9.5	25	3.7	40	47	18	1.4	1.4	12 V / 215 mA
QBH-8924	2050 - 2650	10	25	4.0	42	52	19	1.7	1.5	12 V / 210 mA

All specifications listed are typical at 25°C

| Power Amplifiers |

Efficient amplification is a system designer's goal and we design Linear Class A, Class AB and Non-Linear Class C higher power amplifiers with efficiency in mind. We design both broadband, high linearity amplifiers, as well as high frequency, narrowband, higher power amplifiers to 100 watts with strict attention to size and value. Utilizing both hybrid thick film and SMT technology, our selection of Silicon MOS-FET, LDMOS, GaAs and GaN power amplifiers range from linear broadband 4 watt designs in a compact, surface-mount package, to distributed pulsed power designs which offer many standard features not normally found at this level.

Higher Power Amplifiers (Class AB)

Part Number	Frequency (MHz)	Gain (dB)	P1dB (dBm)	Rev. Iso. (dB)	Input VSWR	Output VSWR	Supply (Volts)	Current (mA @ P1dB)
QBS-343	800 - 960	41	48	50	1.5	1.5	28 V	6000 mA
QBS-549	20 - 1000	27	47	40	1.5	1.6	28 V	5000 mA
QBS-398	1805 - 1880	33	47	50	1.3	1.5	24 V	5000 mA
QBS-517	900 - 1000	48	46	55	2.0	2.0	28 V	4500 mA
QBS-552	876 - 960	34	44	50	1.4	1.4	28 V	3000 mA
QBS-550	1000 - 2500	34	44	50	1.4	1.5	28 V	3000 mA
QBS-553	1710 - 1880	34	44	50	1.5	1.5	28 V	3000 mA
QBS-551	2500 - 6000	34	44	50	1.3	1.2	28 V	3000 mA
QBS-265	1930 - 1990	32	43	46	1.5	1.5	28 V	2000 mA
QBS-276	1930 - 1990	39	42	53	1.5	1.5	28 V	1600 mA
QBS-324	2110 - 2170	39	42	53	1.5	1.5	28 V	1700 mA
QBS-267	2402 - 2452	32	42	45	1.5	1.5	28 V	1700 mA
QBS-258	1920 - 1990	32	41.5	46	1.5	1.5	28 V	1500 mA
QBS-259	2400 - 2450	32	41	46	1.5	1.5	28 V	1400 mA
QB-925	2500 - 6000	18	40	35	2.0	1.6	28 V	2200 mA
QB-904	2000 - 6000	38	35	48	2.0	2.0	24 V	900 mA

API Technologies also offers Integrated Amplifier Subassemblies and Software Configured Power Amplifier solutions.

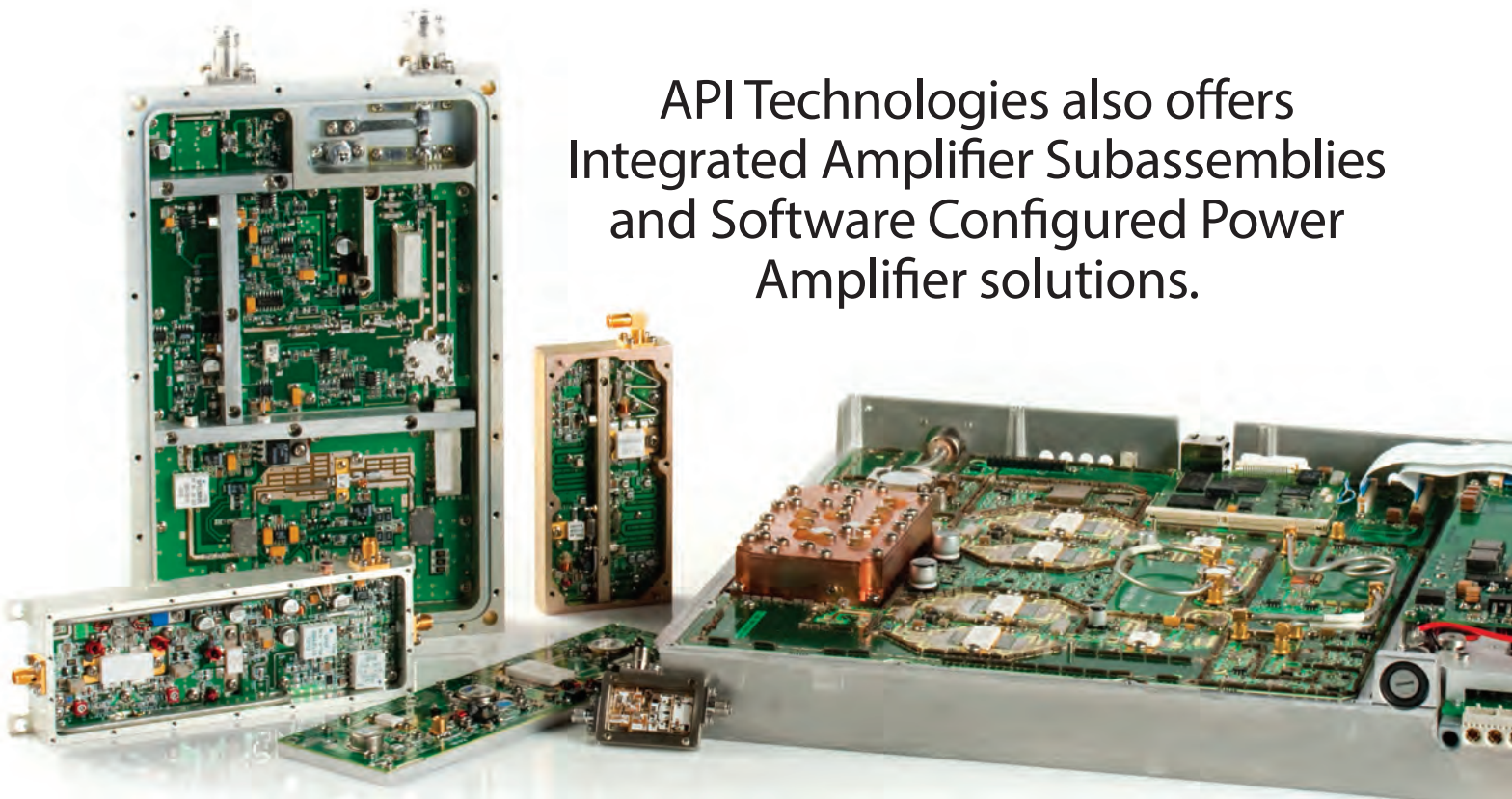

Higher Power Amplifiers (Class A)

Part Number	Frequency (MHz)	Gain (dB)	Noise Figure (dB)	P1dB (dBm)	IP3 (dBm)	IP2 (dBm)	Rev. Iso. (dB)	Input VSWR	Output VSWR	Supply (Volts)	Current (mA @ P1dB)
QBS-544	1 - 30	29	2	46	55	80	40	1.2	1.5	28 V	1000 mA
QBS-545	30 - 512	19	5.5	46	55	76	29	1.5	2.8	24 V	4500 mA
QBS-234	1930 - 1990	40	6	42	52	60	35	2.0	2.0	15 V	5500 mA
QBS-367	2400 - 2450	32	8	42	52	60	50	1.5	1.5	15 V	6500 mA
QBS-330	800 - 960	40	8	42	53	60	52	2.0	2.0	15 V	5000 mA
QBS-229	1800 - 2000	41	7	41	52	60	51	1.5	1.5	15 V	2700 mA
QB-933	50 - 450	12	8	39	63	95	15	1.9	1.9	28 V	1900 mA
QBS-227	860 - 910	40	5	39	49	55	60	2.0	2.0	15 V	2000 mA
QBS-233	1800 - 2200	40	6	39	50	56	55	2.0	2.0	15 V	1500 mA
QBS-204	3700 - 4200	27	8	39	50	55	40	2.0	2.0	15 V	3000 mA
BXMP1034	50 - 450	11	5.5	36	61	90	17	1.9	1.9	15 V	2500 mA
BXMP1008	50 - 250	17	5.6	33.5	43	63	20	1.8	1.8	15 V	600 mA
BXMP1026	50 - 250	31	3.5	33.5	43	63	38	1.8	1.8	15 V	660 mA
BXMP1004	50 - 250	31	3.5	33.5	43	63	38	1.8	1.8	24 V	660 mA
QB-963	2500 - 3500	32	3.5	33.5	45	55	43	1.5	2.0	15 V	700 mA
QBH-2832	1 - 200	35.5	4.5	33	48	70	45	1.5	1.5	28 V	435 mA
QBS-158	800 - 960	21.5	2.5	33	50	55	24	1.5	1.5	24 V	400 mA
QBS-256	1800 - 2000	24	4	33	47	53	35	1.5	1.5	15 V	950 mA
BXMP1001	0.5 - 35	22	3.7	32	49	93	27	1.5	1.5	24 V	425 mA
BXMP1003	5 - 35	22	3.7	32	49	93	27	1.5	1.5	24 V	425 mA
BXMP1029	1 - 35	12	4	31.5	48	91	15	1.8	1.8	15 V	400 mA
QBH-8900	800 - 960	22	3	31.5	47	54	40	1.5	1.5	15 V	350 mA
QB-152	0.5 - 35	21.9	4	31	50	100	31	1.5	1.5	24 V	420 mA
QB-166	1 - 32	12.7	7.8	31	55	110	40	1.5	1.5	24 V	450 mA
QB-101	2 - 70	21.9	4	31	54	105	31	1.5	1.5	24 V	420 mA
BXMP1032	500 - 1000	13	6	31	45	54	17	1.5	1.5	15 V	350 mA
BXMP1037	1000 - 2000	19	5	31	45	54	24	1.5	1.5	15 V	450 mA
BXMP1033	1 - 50	35	5.5	30.5	47	54	45	1.8	1.8	15 V	435 mA
BXMP1002	10 - 100	10	5.5	30.5	45	54	17	1.8	1.8	15 V	320 mA
QB-962	2500 - 3500	31	3.5	30.5	42	52	40	1.5	2.0	15 V	350 mA
QBH-2818	0.35 - 400	18.5	5	30	42	68	23	1.75	1.75	24 V	245 mA
QBH-2830	5 - 200	34.5	4.7	30	46	66	40	1.5	1.5	24 V	300 mA
TM3093	10 - 200	11	5.5	30	42	55	15	1.3	1.4	15 V	330 mA
BXMP1005	10 - 200	21	5.5	30	43	63	15	1.5	1.7	15 V	300 mA
TM3110	10 - 250	15.5	5	30	45	63	17	1.75	1.75	15 V	240 mA
TM3098	10 - 300	13.5	5	30	45	63	17	1.5	1.5	15 V	240 mA
BXMP1000	100 - 1000	12	7	30	43	55	23	1.5	1.5	15 V	350 mA
BXMP1038	20 - 3000	42	5	30	40	49	50	1.5	1.5	15 V	550 mA

All specifications listed are typical at 25°C

Extensive Line of Features

Wide bandwidth and high efficiency are not the only features offered in our full line of higher power amplifiers. API also incorporates many features not normally found among other higher power amplifiers, including:

- ✓ Built-in User Control Interfaces
- ✓ High input protection circuitry
- ✓ Built-in monitoring
- ✓ Voltage Regulators
- ✓ Thermal temperature compensating circuits
- ✓ Harmonic Filters
- ✓ Fault Monitoring
- ✓ Customizable Control Functions
- ✓ Custom Designs Available



For more information please call us at

888.553.7531

Incredible Performance

Our push-pull design techniques, coupled with transistors that have been selected for high linearity characteristics, enable API engineers to achieve this incredible performance including IP2 values better than 110 dBm.



A Cleaner Signal

The center tapped transformer at the input end splits the signal evenly, thus the two amplifiers are driven 180 degrees out of phase. After combining the 2 signals at the output transformer, this equal phase shifting transformation creates a cancelling of the even order harmonics, thus generating a cleaner signal.

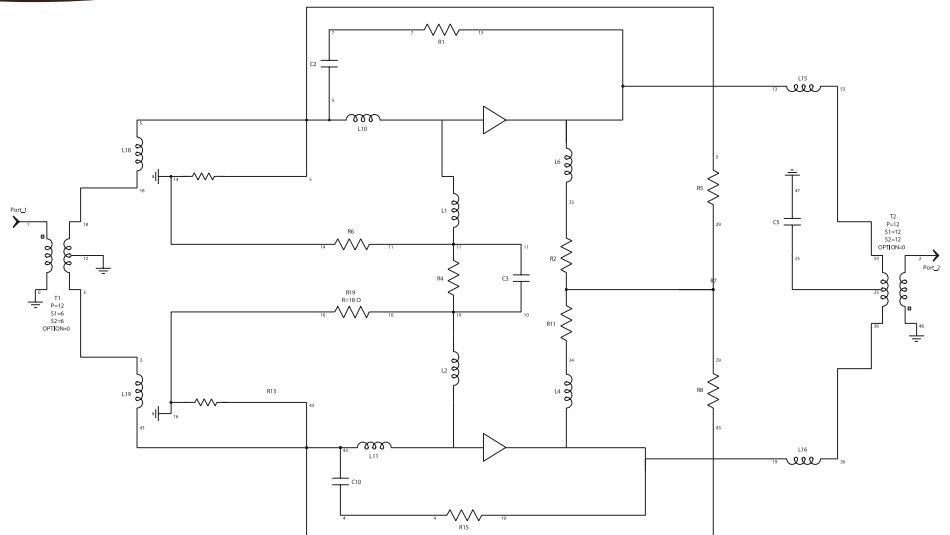

High Linearity Amplifiers

Part Number	Frequency (MHz)	Gain (dB)	P1dB (dBm)	Noise Figure (dB)	IP3 (dBm)	IP2 (dBm)	Rev. Iso. (dB)	Input VSWR	Output VSWR	Supply (+DC/mA)
QB-104	2 - 70	21.9	31	4.5	56	110	31	1.5	1.5	24 V / 400 mA
QB-166	1 - 32	12.7	31	7.8	55	110	40	1.5	1.5	24 V / 450 mA
QB-173	1 - 32	18.3	30	4.3	55	110	30	1.3	1.5	24 V / 450 mA
QB-174	1 - 32	21	30	4.3	55	110	30	1.3	1.5	24 V / 450 mA
QB-141	1 - 33	18	31	5	55	110	29	1.5	1.5	24 V / 450 mA
QB-257	2 - 70	21.9	31	4	55	110	31	1.5	1.5	24 V / 400 mA
QB-205	0.5 - 35	20.2	31	4	50	110	29	1.5	1.5	24 V / 420 mA
QB-326	0.5 - 35	21.9	31	4	50	110	31	1.5	1.5	18 V / 420 mA
QB-101	2 - 70	21.9	31	4	54	105	31	1.5	1.5	24 V / 420 mA
QB-124	20 - 60	25.5	31	4	54	105	31	1.5	1.5	24 V / 420 mA
QB-105	1 - 32	22.7	37	4.3	53	105	30	1.5	1.5	28 V / 1650 mA
QB-152	0.5 - 35	21.9	31	4	50	100	31	1.5	1.5	24 V / 420 mA
QB-933	50 - 450	12	39	6	65	95	15	1.9	1.9	28 V / 1875 mA
BXMP1027	50 - 500	10.5	37	4	61	95	17	1.5	1.5	15 V / 2200 mA
BXMP1001	1 - 35	22	32	3.7	49	93	27	1.5	1.5	24 V / 425 mA
BXMP1003	5 - 35	22	32	3.7	49	93	27	1.5	1.5	24 V / 425 mA
BXMP1012	0.5 - 35	22	32	3.7	49	93	27	1.5	1.5	24 V / 425 mA
BXMP1029	1 - 35	12	31.5	4	48	91	15	1.8	1.8	15 V / 400 mA
BXMP1034	50 - 450	11	36	5.5	61	90	17	1.9	1.9	15 V / 2500 mA
BXMP1030	1 - 200	16	28	4	43	80	22	1.8	1.8	15 V / 250 mA
WN3105	0.5 - 300	12	28	4.5	44	75	15	1.5	1.5	15 V / 235 mA
BXMP1006	20 - 600	13.5	28	5.5	40	73	22	1.5	1.5	15 V / 250 mA
BXMP1031	50 - 100	13.5	28.5	5.5	40	73	22	1.5	1.5	15 V / 250 mA
QB-7223	1 - 32	23	34	4	50	70	30	1.5	1.5	28 V / 825 mA
QBH-2832	1 - 200	35.5	33	4.5	48	70	44	1.5	1.5	28 V / 435 mA
QBH-2830	5 - 200	34.5	30	4.7	46	70	44	1.5	1.5	24 V / 300 mA
BXMP1018	1 - 100	16	28	4	44	70	22	1.6	1.6	15 V / 250 mA
BXMP1019	10 - 300	10.8	28	5	42	70	16	1.7	1.7	15 V / 235 mA
BXMP1009	5 - 500	18	22	4.5	36	70	26	1.5	1.5	15 V / 160 mA
BXMP1010	5 - 500	18	21.5	4.5	35	69	27	1.3	1.3	15 V / 160 mA
QBH-2818	0.35 - 400	18.5	30	5	42	68	23	1.75	1.75	24 V / 245 mA
BXMP1025	500 - 1000	14	32	5	45	65	23	1.5	1.7	15 V / 490 mA
TM3110	10 - 250	15.5	30	5.0	45	63	17	1.75	1.75	15 V / 240 mA
TM3098	10 - 300	13.5	30	5	45	63	17	1.5	1.5	15 V / 240 mA
WNMP1045	10 - 200	20	30	5.5	43	63	40	1.5	1.5	15 V / 310 mA
BXMP1005	10 - 200	21	30	5.5	43	63	15	1.5	1.7	15 V / 300 mA
BXMP1008	50 - 250	17	33.5	5.6	43	63	20	1.8	1.8	15 V / 600 mA
BXMP1026	50 - 250	31	33.5	3.5	43	63	38	1.8	1.8	15 V / 660 mA
QBS-158	800 - 960	21.5	33	2.5	50	60	24	1.5	1.5	24 V / 790 mA
TR3111	1 - 300	13.5	27.5	4.0	44	60	17	1.8	1.8	15 V / 180 mA
BXMP1000	100 - 1000	10	30	7	43	60	20	1.8	1.8	15 V / 350 mA
TM3106	500 - 2500	11	20	4.0	42	60	22	1.5	1.5	15 V / 195 mA
QB-971	2500 - 3500	32	33.5	3.5	45	58	53	1.5	2.0	15 V / 1000 mA
QBS-256	1800 - 2000	24	33	7	47	57	35	1.5	1.5	15 V / 1100 mA
BXMP1046	500 - 2700	27	27.5	2.0	42	56	40	1.25	1.25	12 V / 290 mA
TM3093	10 - 200	11	30	5.5	42	55	15	1.3	1.4	15 V / 330 mA
QB-970	2500 - 3500	31	30.5	3.5	42	55	53	1.5	1.5	15 V / 600 mA
QB-188	0.5-100	15	21	3	41	55	28	1.5	1.5	15 V / 85 mA
TM3109	20 - 500	15	26	1.8	40	55	20	1.5	1.5	15 V / 160 mA
TM3108	20 - 500	29	26	2.5	40	55	40	1.5	1.5	15 V / 160 mA
BXMP1043	500 - 2000	23	30	4.0	40	55	40	1.8	1.8	15 V / 500 mA
BXMP1036	500 - 3000	30	25	2	40	55	37	1.75	1.75	15 V / 280 mA
TM3107	500 - 2500	20	24	3.5	38	55	30	1.5	1.5	15 V / 160 mA
BXMP1033	1 - 50	35	30.5	5.5	47	54	45	1.8	1.8	15 V / 435 mA
QBH-8900	800 - 960	22	31.5	3	47	54	40	1.5	1.5	15 V / 350 mA
BXMP1002	10 - 100	10	30.5	5.5	45	54	17	1.8	1.8	15 V / 320 mA
BXMP1037	1000 - 2000	19	31	5	45	54	24	1.5	1.5	15 V / 450 mA
BXMP1032	500 - 1000	13	32	6	45	54	17	1.5	1.5	15 V / 400 mA
BXMP1007	2400 - 3600	19.5	22.5	4	33	52	50	1.6	1.35	15 V / 145 mA
BXMP1042	30 - 2000	22	29	4.0	40	50	40	1.5	1.8	15 V / 350 mA
BXMP1035	500 - 3000	38	24.5	1.6	40	50	55	1.8	1.8	15 V / 220 mA
BXMP1044	500 - 3000	30	26	3.0	38	50	60	1.5	1.5	15 V / 370 mA
BXMP1038	20 - 3000	42	30	5	40	49	50	1.5	1.5	15 V / 550 mA

Low Phase Noise Amplifiers

Model	Frequency (MHz)	Gain (dB)	P1dB (dBm)	N.F. (dB)	IP3 (dBm)	IP2 (dBm)	Rev. Iso. (dB)	Input VSWR	Output VSWR	Phase Noise @100 kHz Offset (dBc/Hz) Typ/Max	Supply (+DC/mA)
TM6162PM	10 - 100	12.5	16	1.4	32	46	15	1.5	1.5	-170 / -167	15 V / 13 mA
TM7111PM	10 - 100	12.5	17	1.4	33	47	15	1.8	1.8	-165 / -161	15 V / 14 mA
TM5834PM	10 - 100	19.7	27.5	3.5	40	52	25	1.7	1.3	-176 / -172	15 V / 135 mA
TM5125PM	10 - 100	20.5	24	2	40	52	24	1.7	1.4	-176 / -172	15 V / 80 mA
TM5325PM	10 - 100	20.5	24	2	40	52	24	1.7	1.4	-176 / -172	12 V / 85 mA
TM5338PM	5 - 150	15	25	2.7	36	44	20	1.5	1.3	-178 / -174	12 V / 88 mA
TM5138PM	5 - 150	15.5	23	3.1	38	46	27	1.6	1.6	-176 / -172	15 V / 90 mA
TM5149PM	5 - 150	23.5	18	3	33	37	29	1.5	1.5	-164 / -160	15 V / 35 mA
TM5171PM	20 - 150	13.5	27	6.5	39	50	25	1.5	1.5	-178 / -174	15 V / 105 mA
QBH-5730PM	10-160	21	24	4.5	36	46	35	1.5	1.3	-178 / -175	15 V / 100 mA
TM7379PM	5 - 200	14	23	4.5	38	47	16	1.5	1.5	-174 / -170	12 V / 88 mA
TM6118PM	10 - 200	10	18	1.5	33	55	12	1.2	1.2	-174 / -170	15 V / 18 mA
TM5137PM	10 - 200	12.7	22.5	3.5	39	53	18	1.6	1.8	-178 / -174	15 V / 75 mA
TM3110PM	10 - 200	15.5	30.0	3.5	45	63	17	1.8	1.8	-175 / -170	15 V / 240 mA
TM5136PM	10 - 200	20	21	4	33	45	26	1.5	1.5	-173 / -169	15 V / 70 mA
TM6121PM	20 - 200	10	20	2.5	38	55	18	1.8	1.8	-179 / -175	15 V / 60 mA
TM6134PM	20 - 200	14.3	26	4	39	54	17	1.6	1.4	-178 / -174	15 V / 90 mA
TM5124PM	20 - 200	20.5	20	2.5	34	44	24	1.5	1.2	-170 / -166	15 V / 53 mA
TM7211PM	30 - 200	8.5	20	1.8	40	55	12	1.75	1.35	-181 / -177	15 V / 30 mA
TM7212PM	30 - 200	8.5	20	1.8	40	55	12	1.75	1.35	-172 / -168	12 V / 30 mA
QBH-5715PM	100-200	14	26	4.5	38	50	19	1.3	1.5	-180 / -175	10 V / 155 mA
TM7277PM	5 - 250	10.5	24	4	41	48	12	1.5	1.8	-175 / -171	15 V / 70 mA
TM7279PM	5 - 250	14	23	4.5	36	46	15	1.5	1.5	-178 / -174	15 V / 88 mA
TM6670PM	10 - 250	8	20	1.8	36	46	11	1.5	1.5	-176 / -173	15 V / 25 mA
TM7382PM	20 - 250	18	17.5	4	29	31	32	1.5	1.2	-166 / -162	15 V / 45 mA
TM7281PM	20 - 250	25.5	17.5	2.4	31	35	32	1.5	1.8	-161 / -157	15 V / 30 mA
BXMP1008PM	50 - 250	17	33.5	5.6	43	63	20	1.8	1.8	-160 / -155	15 V / 600 mA
TM5103PM	5 - 300	11.5	23	5	36	45	14	1.3	1.3	-177 / -173	15 V / 85 mA
TM7347PM	5 - 300	13.5	16	2	32	44	22	1.5	1.5	-175 / -172	15 V / 45 mA
TM7278PM	5 - 300	13.5	21.5	4	36	49	15	1.3	1.5	-176 / -172	15 V / 65 mA
TM5155PM	5 - 300	15	22	5	37	48	17	1.8	1.8	-178 / -175	15 V / 85 mA
TM3072PM	10 - 300	13.5	27.5	5	44	60	17	1.5	1.5	-180 / -175	15 V / 180 mA
TM3098PM	10 - 300	13.5	30	5	45	63	17	1.5	1.5	-180 / -175	15 V / 240 mA
TM3041PM	10 - 300	16.5	24	2.8	38	50	20	1.8	1.8	-175 / -170	15 V / 80 mA
TM5152PM	10 - 300	17	20	3.5	33	47	20	1.8	1.5	-174 / -172	15 V / 55 mA
TM7207PM	10 - 300	18	16	2	31	42	21	1.7	1.7	-172 / -168	15 V / 33 mA
TM5150PM	10 - 300	20	18	2.5	32	43	23	1.8	1.5	-173 / -170	15 V / 47 mA
TM7481PM	15 - 300	28	16.5	2.3	29	33	32	1.8	1.8	-160 / -156	15 V / 27 mA
QBH-1507PM	30-320	8	22	2.2	41	60	11	1.4	1.3	-182 / -175	15V / 32 mA
TM6487PM	10 - 400	15.5	17.5	3.2	32	45	20	1.5	1.7	-174 / -170	15 V / 33 mA
TM6442PM	20 - 400	14	22	4.5	37	51	19	1.1	1.3	-175 / -171	15 V / 62 mA
TM6441PM	20 - 400	14.5	16	3.5	31	48	19	1.5	1.8	-174 / -170	15 V / 32 mA
TM6603PM	5 - 500	10	15.5	5.5	30	42	15	1.5	1.5	-175 / -171	24 V / 50 mA
TM6559PM	5 - 500	11.5	22	5.5	36	46	15	1.5	1.5	-174 / -170	15 V / 88 mA
TM6558PM	5 - 500	12	19	4.8	36	48	16	1.5	1.5	-173 / -170	15 V / 65 mA
TM6515PM	5 - 500	12.5	16.5	4.5	31	43	16	1.5	1.5	-174 / -170	15 V / 50 mA
TM6518PM	5 - 500	14	25	5	33	40	13	1.6	1.7	-174 / -170	15 V / 125 mA
TM6010PM	5 - 500	14.5	23	4.6	36	50	18	1.4	1.2	-175 / -172	10 V / 145 mA
TM6509PM	5 - 500	14.5	23	4.6	36	50	18	1.4	1.2	-180 / -172	15 V / 88 mA
TM6012PM	5 - 500	14.5	23	4.6	36	50	18	1.4	1.2	-180 / -172	12 V / 88 mA
TM5126PM	5 - 500	15	17	3	32	42	21	1.5	1.8	-174 / -170	15 V / 50 mA
TM5119PM	5 - 500	15.5	16	2.3	32	44	19	1.8	1.8	-173 / -169	15 V / 30 mA
TM6577PM	5 - 500	16.5	17	3.5	32	42	18	1.5	1.5	-172 / -168	15 V / 50 mA
TM6533PM	5 - 500	16.5	17	3.5	32	42	18	1.5	1.5	-174 / -171	15 V / 50 mA
TM6513PM	5 - 500	17	16.5	3.8	29	41	19	1.5	1.8	-170 / -166	24 V / 50 mA
TM6576PM	5 - 500	28	16	5	30	52	34	1.5	1.5	-160 / -156	15 V / 64 mA
TM6131PM	10 - 500	10.3	20	4.5	37	50	22	1.3	1.3	-177 / -173	15 V / 62 mA
TM6545PM	10 - 500	11.5	20.5	4	36	48	15	1.3	1.5	-175 / -171	15 V / 60 mA
TM6544PM	10 - 500	12	15	2	32	46	15	1.4	1.5	-174 / -170	15 V / 35 mA
TM6547PM	10 - 500	12.5	19	4	35	48	17	1.8	1.5	-175 / -172	15 V / 55 mA
TM6519PM	10 - 500	14.3	19	5.5	34	40	16	1.5	1.6	-170 / -166	15 V / 70 mA
QBH-1401PM	10-500	14.5	12	3.6	22	34	55	1.2	1.3	-176 / -170	15 V / 42 mA
TM6507PM	10 - 500	15.5	24	4	35	40	17	1.5	1.7	-175 / -172	15 V / 110 mA
TM5122PM	10 - 500	17	20	4.2	30	38	22	1.8	1.8	-173 / -170	15 V / 60 mA

Low Phase Noise Amplifiers

Model	Frequency (MHz)	Gain (dB)	P1dB (dBm)	N.F. (dB)	IP3 (dBm)	IP2 (dBm)	Rev. Iso. (dB)	Input VSWR	Output VSWR	Phase Noise @100 kHz Offset (dBc/Hz) Typ/Max	Supply (+DC/mA)
TM4002PM	10 - 500	20	19.5	4	35	45	23	1.4	1.3	-170 / -165	15 V / 80 mA
TM4003PM	10 - 500	20	19.5	4	35	45	23	1.4	1.3	-170 / -165	5 V / 80 mA
TM6526PM	10 - 500	28	21	3.5	35	50	36	1.5	1.5	-164 / -160	15 V / 93 mA
TM6581PM	20 - 500	22	16	3.5	28	40	29	1.5	1.5	-166 / -162	15 V / 27 mA
TM6191PM	100 - 600	23.5	21.5	2.5	36	52	35	1.3	1.5	-169 / -165	15 V / 95 mA
WN6160PM	100 - 600	28	17	2	32	46	43	1.75	1.75	-160 / -156	15 V / 65 mA
TM6659PM	10 - 700	10.5	22	6.5	36	46	14	1.8	1.5	-180 / -176	15 V / 88 mA
TM9167PM	10 - 800	12.5	15.5	4.5	30	45	15	1.5	1.8	-173 / -169	15 V / 32 mA
TM9118PM	10 - 800	14.7	16	4.5	26	33	19	1.5	1.5	-171 / -167	15 V / 45 mA
TM9119PM	10 - 1000	9	21	8.5	34	40	13	1.5	1.5	-179 / -175	15 V / 100 mA
TM9333PM	5 - 1000	11.5	16	5	30	44	15	1.3	1.5	-173 / -169	15 V / 48 mA
TM9106PM	5 - 1000	12	19	4.8	27	32	14	1.8	1.5	-175 / -172	15 V / 70 mA
TM9105PM	10 - 1000	12.5	21	4.5	35	45	15	1.5	1.5	-180 / -175	15 V / 90 mA
TM9510PM	10 - 1000	12.5	21	4.5	35	45	15	1.5	1.5	-180 / -175	10 V / 145 mA
TM9512PM	10 - 1000	13	21	4.5	35	45	15	1.5	1.5	-180 / -175	12 V / 90 mA
TM9723PM	10 - 1000	13	27	4	40	48	18	1.75	1.5	-178 / -173	15 V / 185 mA
QBH-1424PM	10 - 1000	13	26	5.5	32	39	17	1.5	1.5	-181 / -178	15 V / 155 mA
QBH-1423PM	10 - 1000	13	28	6	34	40	17	1.5	1.5	-180 / -175	15 V / 195 mA
QBH-1505PM	10 - 1000	13	28	6	34	40	17	1.5	1.5	-180 / -175	12 V / 195 mA
TM9518PM	10 - 1000	14.7	16	4	29	41	17	1.5	1.5	-168 / -165	15 V / 44 mA
TM9318PM	10 - 1000	14.7	16	3.8	30	42	18	1.5	1.5	-173 / -169	15 V / 47 mA
TM6155PM	300 - 1000	12.5	19.5	4	33	45	13	1.5	2.0	-177 / -174	15 V / 50 mA
TM6345PM	10 - 1100	12.3	17	3	33	46	13	1.5	1.8	-175 / -172	15 V / 45 mA
TM5154PM	200 - 1200	12.8	8	2.6	21	31	23	1.5	1.5	-162 / -158	15 V / 23 mA
TM9329PM	10 - 1500	9	20	6.5	30	36	11	1.8	1.8	-173 / -169	15 V / 90 mA
TM9128PM	10 - 1500	11.5	15	4.5	29	43	14	1.5	1.5	-170 / -166	15 V / 40 mA
QBH-5817PM	10 - 1500	13.5	20	6	32	44	13	1.5	1.5	-181 / -177	15 V / 100 mA
TM5817PM	10 - 1500	14	23	6	32	44	20	1.5	1.75	-175 / -171	15 V / 98 mA
TM9126PM	10 - 1500	20.5	15	5	28	45	30	1.5	1.5	-165 / -162	15 V / 64 mA
TM9524PM	10 - 1500	22	13	4.3	23	31	33	1.8	1.8	-163 / -160	15 V / 56 mA
TR9771PM	1200 - 1700	27	15	1	26	40	38	1.8	1.8	-162 / -158	15 V / 60 mA
TM9137PM	10 - 2000	9.5	15.5	6.5	28	38	11	1.8	1.5	-173 / -170	15 V / 45 mA
TM9138PM	10 - 2000	7.5	19	6	33	46	11	1.8	1.5	-172 / -168	15 V / 65 mA
TM9327PM	10 - 2000	15	17.5	6.5	29	38	27	1.3	1.5	-168 / -164	15 V / 108 mA
QBH-4012PM	100 - 2000	19.5	23	3.2	33	52	35	1.5	1.8	-165 / -172	15 V / 190 mA

All specifications listed are typical at 25°C. Phase noise performance typically tested at midband.

With over 100 guaranteed low phase noise amps to choose from, it is clear why API is the company engineers turn to when they need superior, guaranteed low phase noise performance.

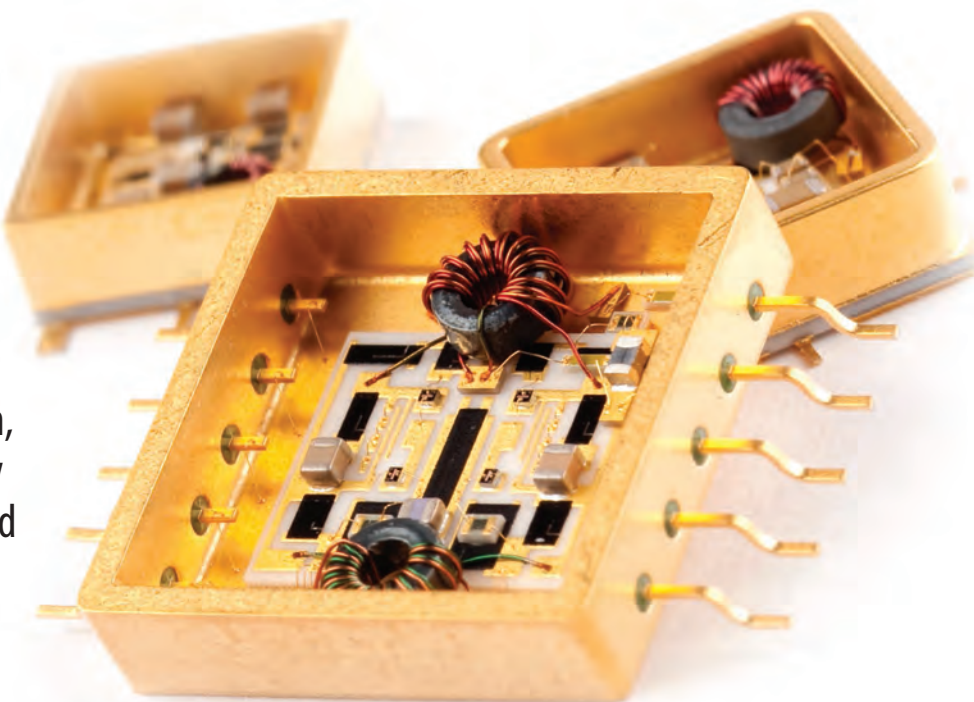



Commitment to High Quality

With over 20 awards and accolades to its credit, API Technologies' reputation for quality and performance is the reason why leading military and technology firms choose API for their amplification requirements.

With its strong commitment to quality, API units are tested a minimum of three times during the production cycle to ensure that all units delivered to their customers exceed expectations for performance and reliability part-to-part, and lot-to-lot.



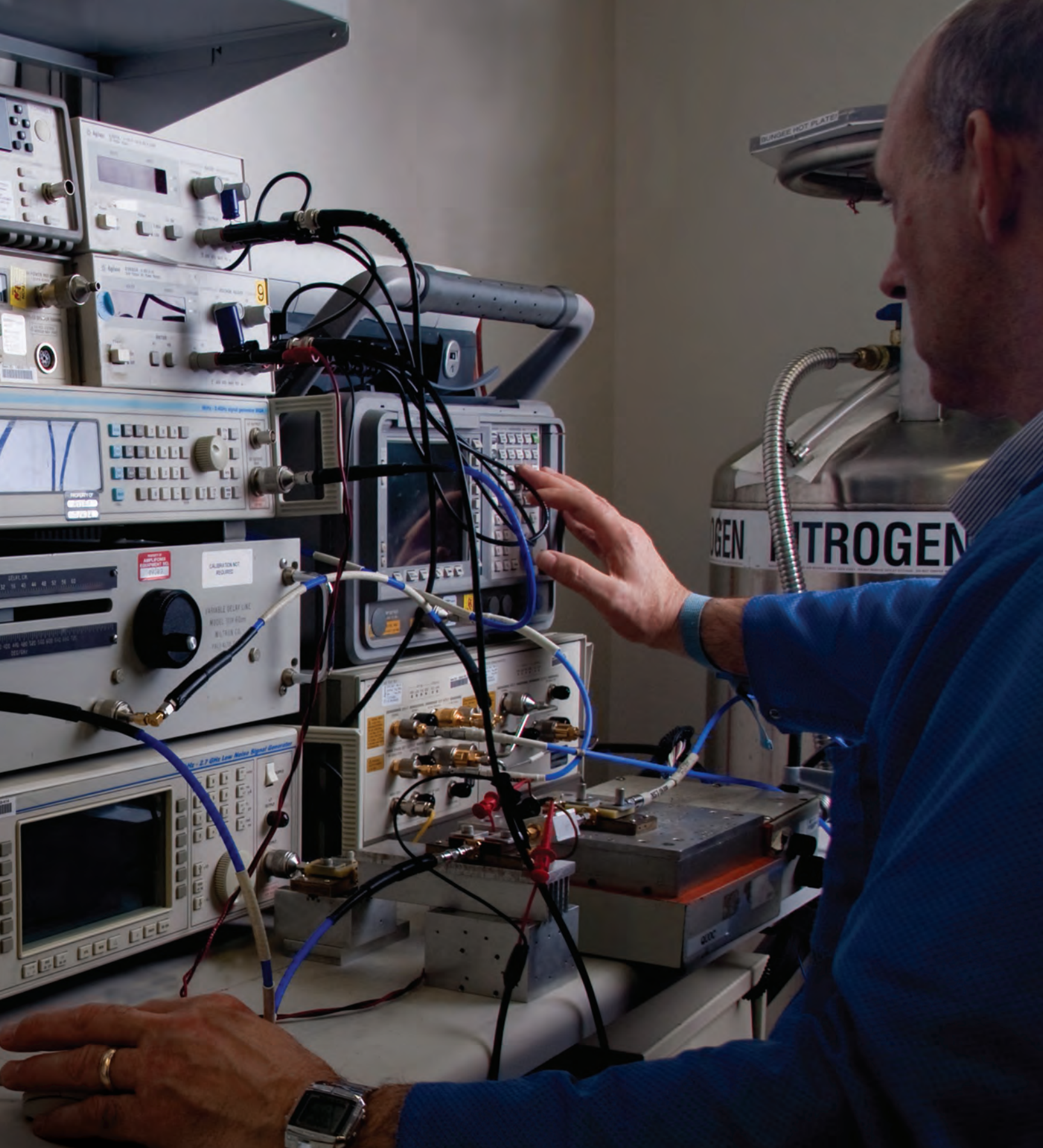

Guaranteed Performance

We achieve guaranteed (100% tested) performance using high quality silicon bipolar transistors in unique circuits up to 2 GHz.

| Low Phase Noise Amplifiers |

Integral to finding solutions to frequency control problems is the ability to test for compliance. In order to successfully test these complex designs, we have invested heavily in high performance test equipment including Agilent PNA network analyzers with calibrated performance to 50 GHz, low phase noise signal generators, an Agilent ES5500 phase noise measurement system, and additional in-house environmental test equipment.

Model QBH-1423PM (10-1000 MHz)

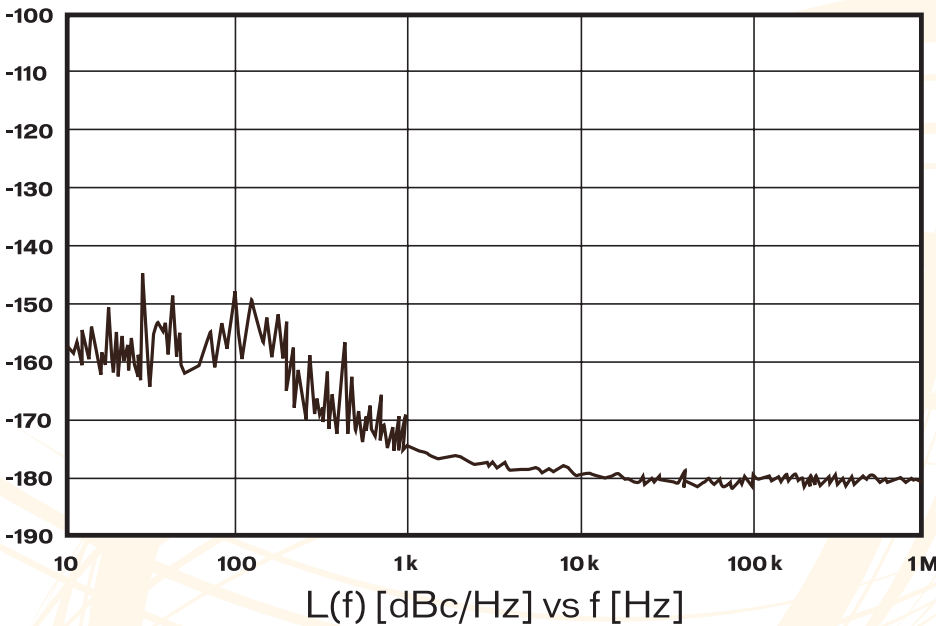

Guaranteed Phase Noise Performance (dBc/Hz)

Frequency Offset	Typical	Guaranteed
100 Hz	-160	-155
1 kHz	-175	-170
10 kHz	-180	-175
100 kHz	-180	-175
1 MHz	-180	-175

Phase Noise performance is guaranteed and plots are provided

Ultra Low Phase Noise Performance

Better phase noise is a performance requirement often sought in today's most advanced systems. API achieves guaranteed ultra low phase noise performance in its amplifiers using a combination of design techniques, material selection, and in-house testing.

Lower phase noise means...

- Spurious signal suppression
- Better S/N ratio
- Improved sub-clutter visibility



Total Customer Satisfaction

API Technologies provides total customer satisfaction by manufacturing and delivering the industry's highest quality RF products, which consistently meet and exceed our customer's expectations for performance, price, and delivery. We ensure continuous improvements in our products, processes and people.

Teledyne/Cougar Cross Reference List

Cougar	API Technologies	Cougar	API Technologies	Cougar	API Technologies	Cougar	API Technologies
AC105	TM7105	AC540	TM5101	AC1063	TM9163	AC2348	TM9748
ACH107	TM7207	AC541	TM5110	AC1066	TM9366	AC2366	TM9343
AP148	TM6148	AC542	TM6147	AC1068	TM9368	AC2426	TM9342
AC251	TM7570	AC543	TM6543	AC1069	TM9369	AP2509	TM9759
AC262	TM9262	AC544	TM6544	AC1082	TM9107	AC2546	TM9546
AC263	TM9263	AC545	TM6645	AR1094	TR9794	AC2564	TM9704
AC271	TM7270	AC547	TM6657	AC1218	TM9340	AC2577	TM9777
AC272	TM7172	AC548	TM6547	AC1219	TM9339	AC2578	TM9345
AC273	TM7370	AC555	TM6416	AC1226	TM9337	AR2584	TM9784
AC281	TM7481	AC556	TM6576	AC1228	TM9344	AP3007	TM9307
AC282	TM7182	AC557	TM6516	AC1264	TM9164	AP3008	TM9308
AC293	TM7193	AC558	TM6545	AC1266	TM9166	AP3009	TM9309
AP294	TM7294	AC559	TM6655	AC1269	TM9269	AP3028	QBH-3022
AC305	TM7147	AP561	TM6661	AP1309	TM9769	AC3056	TM9356
AC345	TM7145	AC564	TM6664	AC1523	TM9523	AR3056	TR9156
AC347	TM7347	AC566	TM6524	AC1525	TM9225	AC3057	TM9057
AP348	TM7148	AC572	TM6520	AC1526	TM9126	AC3064	TM9064
AR356	TR7256	AC573	TM5673	AC1527	TM9127	AR3069	QBH-4037
AC378	TM7278	AC575	TM6575	AC1528	TM9128	AP3509	TM9509
AC379	TM7279	AC576	TM6276	AC1529	TM9329	AC3547	TM9547
AC380	TM7381	AC577	TM6577	AP1532	TM9785	AR3569	TR9569
AC381	TM7281	AC580	TM6517	AC1569	TM7569	AC3579	TM9579
AC382	TM7282	AC581	TM6581	AC1582	TM9328	AC4041	TM9441
AC383	TM6683	AC582	TM6582	AC1586	TM9524	AC4045	TM9445
AC386	TM7386	AC583	TM6583	AP2008	TM9708	AP4048	TM9448
AP388	TM7388	AP719	TM9019	AP2009	TM9709	AR4048	TR9048
AP389	TM7189	AC751	TM9751	AC2017	TM9317	AC4054	TM9454
AC391	TM7291	AC829	TM6345	AC2023	TM9322	AC4056	TM9456
AC437	TM6587	AC838	TM9183	AC2025	TM9341	AC4064	TM9464
AP448	TM6448	AC847	TM9147	AC2034	TM9134	AC4066	TM9066
AC453	TM6443	AC848	TM9148	AR2036	TR9036	AC4079	TM9479
AC457	TM6444	AC936	TM9192	AC2037	TM9137	AC4086	TM9486
AC487	TM6487	AC986	TM9186	AC2038	TM9138	AC4088	TM9488
AC501	TM6501	AC1012	TM9102	AC2039	TM9139	AC6066	QBH-5729
AC505	TM6505	AC1017	TM9117	AC2046	TM9146	GC2001	TG9001
AC508	TM6558	AC1018	TM9118	AC2056	TM9056	GC2530	TG9030
AC509	TM6509	AC1019	TM9319	AC2058	TM9728	LA507	TL9002
AC513	TM6675	AC1022	TM9311	AC2066	TM9266	LA1017	TML9017
AC514	TM6614	AC1035	TM9335	AR2066	TR9466	LC1501	TL9013
AC518	TM6526	AC1036	TM9113	AR2067	TR9067	LC1502	TL9014
AC519	TM6619	AC1038	TM9338	AC2075	TM9725	LG2001	TL9003
AC524	TM6574	AC1054	TM9325	AC2091	TM9091	A2CP12024	QB-947
AC525	TM6625	AP1059	TM9359	AC2092	TM9092		
AC536	TM6654	AP1060	TM9360	AC2078	TM9778		

For more information please call us at

888.553.7531

Teledyne/Cougar (Avantek) Cross Reference List

Teledyne/Cougar	API Technologies	Teledyne/Cougar	API Technologies	Teledyne/Cougar	API Technologies	Teledyne/Cougar	API Technologies
GPD110	CZ8110	UTC11-108	BX1558-4	UTO510	TM6510	UTO1002	TM9102
GPD120	CZ8120	UTC12-104	BX2531-4	UTO511	TM6511	UTO1005	TM9105
GPD130	CZ8130	UTO101	TM7101	UTO512	TM6512	UTO1006	TM9106
GPD201	CZ8201	UTO102	TM7102	UTO513	TM6513	UTO1007	TM9107
GPD202	CZ8202	UTO103	TM7103	UTO514	TM6514	UTO1011	TM9111
GPD251	CZ8251	UTO104	TM7104	UTO515	TM6515	UTO1012	TM9312
GPD310	CZ8310	UTO111	TM7111	UTO516	TM6516	UTO1013	TM9313
GPD320	CZ8320	UTO210	TM7210	UTO517	TM6517	UTO1023	QBH-1423
GPD330	CZ8330	UTO211	TM7211	UTO518	TM6518	UTO1024	QBH-1424
GPD401	CZ8401	UTO221	TM7221	UTO519	TM6519	UTO1033	TM9333
GPD402	CZ8402	UTO222	TM7222	UTO520	TM6520	UTO1043	TM9143
GPD403	CZ8403	UTO250	TM7250	UTO521	TM6521	UTO1044	TM9144
GPD404	CZ8404	UTO311	TM6570	UTO523	TM6523	UTO1502	TM9502
GPD405	CZ8405	UTO416	TM6416	UTO524	TM6524	UTO1522	TM9522
GPD461	CZ8461	UTO421	TM6421	UTO526	TM6526	UTO1524	TM9524
GPD462	CZ8462	UTO440	TM6440	UTO533	TM6533	UTO2012	TM9712
GPD463	CZ8463	UTO441	TM6441	UTO543	TM6543	UTO2013	TM9713
GPD464	CZ8464	UTO442	TM6442	UTO544	TM6544	UTO2022	TM9322
GPM1052	CZ8052	UTO443	TM6443	UTO545	TM6545	UTO2023	TM9323
UTC5-115	BX2530-4	UTO444	TM6444	UTO546	TM6546	UTO2024	TM9324
UTC5-123	BX1556-4	UTO501	TM6601	UTO547	TM6547	UTO2025	TM9725
UTC5-133	BX1557-4	UTO502	TM6605	UTO549	TM6549	UTO2027	TM9327
UTC5-135	BX2529-4	UTO503	TM6603	UTO552	TM6152	UTO2052	TM9352
UTC5-142	BX2532-4	UTO504	TM6704	UTO554	TM6654	UTO2055	TM9355
UTC5-150	BX1561-4	UTO505	TM6705	UTO561	TM6561	UTO2302	TM9302
UTC5-152	BX1560-4	UTO507	TM6507	UTO573	QBH-1401	UTO2321	TM6321
UTC11-102	BX1559-4	UTO509	TM6509	UTO1001	TM9101		

M/A-Com (Watkins-Johnson) Cross Reference List

M/A-Com	API Technologies	M/A-Com	API Technologies	M/A-Com	API Technologies	M/A-Com	API Technologies
A-1	TM6501	A-29-1	TM9329	A-66-3	TM9566	A-82	TM7282
A-3	TM6503	A-31-1	TM9331	A-67	TM9167	A-82-1	TM6588
A-5	TM6505	A-32	TM9132	A-67-1	TM6667	A-83	TL9012
A-5-5	TM6605	A-33	TM9133	A-70	TM7170	A-83-1	TM7287
A-7	TM6607	A-34	TM9134	A-70-1	TM7270	A-86	TR6689
A-9	TM6609	A-35	TM9135	A-70-3	TM7370	A-87	TM6203
A-11	TM9111	A-36	TM9136	A-71	TM7271	A-87-1	TM6212
A-11-2	TM9311	A-36-1	TM9336	A-70-2	TM6670	A-88	TM9723
A-12	TM9112	A-37	TM9137	A-72	TM6572	AL-7	TR9737
A-13	TM9113	A-38	TM9138	A-73	TM6573	A-87-2	TM6238
A-16-2	TM9316	A-39	TM9139	A-74	TM6574	RA-89-1	TR9666
A-17	TM9117	A-45	TM9745	A-74-1	TM7274	PA-3	TR9169
A-18	TM9118	A-54	TM6554	A-74-2	TM6674	PA-12	TR6676
A-18-1	TM9318	A-55	TM6555	A-75	TM6675	PA-15	TR6589
A-19	TM9119	A-56	TM6556	A-75-2	TM7275	PA-37	TM7382
A-19-1	TM9319	A-57	TM6557	A-75-3	TM6675	PA-38	TM6583
A-23	TM9123	A-58	TM6558	A-76	TM6576	RA-66	TM6683
A-24	TM9124	A-59	TM6559	A-77	TM6577	RA-69	TM7286
A-25	TM9125	A-59-1	TM6659	A-77-1	TM6575	RA-76	TM6587
A-25-1	TM9325	A-63	TM9163	A-78	TM7278	RA-89	TM6487
A-26	TM9126	A-63-1	TM9363	A-79	TM7279		
A-27	TM9127	A-64	TM9164	A-81	TM7281		
A-28	TM9128	A-65	TM9165	A-81-1	TM7381		
A-28-2	TM9328	A-66	TM9166	A-81-2	TM6581		
A-29	TM9129	A-66-1	TM9366	A-81-3	TM6681		

API offers Form, Fit & Function Cross Referenced Units to other manufacturers' old, obsolete and long lead-time amplifiers

Motorola Cross Reference List

Motorola	API Technologies	Motorola	API Technologies	Motorola	API Technologies	Motorola	API Technologies
MWA110	CZ8110	MWA210	CZ8210	MWA310	CZ8310	CA2810	QBH-2810
MWA120	CZ8120	MWA220	CZ8220	MWA320	CZ8320	CA2818	QBH-2818
MWA130	CZ8130	MWA230	CZ8230	MWA330	CZ8330	CA2832	QBH-2832

M/A-Com (Anzac) Cross Reference List

M/A-Com	API Technologies	M/A-Com	API Technologies	M/A-Com	API Technologies	M/A-Com	API Technologies
AMC103	TM6103	AM143	TM6143	AM157	TM6157	AMC123	BX6131
AM112	TM6112	AM145	TM6145	AM162	TM6162	AMC183	TM6183
AM117	TM6117	AM146	FP6146	AM171	TM6171	AM184	TM6184
AM119	TM6119	AM147	TM6147	AM176	TM6176	AT101	FPG9101
AM124	TM6124	AM149	TM6149	AM181	TM6181		
AM131	TM6131	AM153	TM6153	AM191	TM6191		
AM134	FP6134	AM155	TM6155	AM210	TM6210		

API Technologies has always understood that customer service is what breeds customer loyalty. So, in keeping with our “customer first” policy, API maintains this active Cross Reference Guide to make it easier to offer a better alternative for a wide variety of amplifier vendors’ products.

For more information please call us at

888.553.7531

M/A-Com (Phoenix Microwave) Cross Reference List

M/A-Com	API Technologies	M/A-Com	API Technologies	M/A-Com	API Technologies	M/A-Com	API Technologies
PA002	TM7302	PA350	TM4350	PA820	TM7282	PA964	TM4164
PA005	TM6505	PA360	TM9136	PA860	TM7286	PA965	TM6147
PA10	TM5110	PA370	TM9137	PA861	TM9313	PA966	TM7966
PA010	TM6511	PA380	TM9180	PA870	TM6587	PA967	TM4767
PA015	TM9717	PA381	TM9381	PA871	TM6487	PA968	TM4768
PA030	TM6530	PA390	TM9139	PA890	TM4190	PA969	TR4769
PA050	TM6550	PA510	TM5107	PA891L	TR6689	PA970	TM4770
PA055	TM7055	PA530	TM6143	PA899	TM6599	PA971	TM4771
PA056	TM7056	PA540	TM6554	PA902	TM6509	PA972	TM4172
PA100	TM9716	PA550	TM6555	PA903	TM5103	PA973	TM4773
PA110	TM9110	PA560	TM6556	PA905	TM5101	PA973A	TM4773A
PA112	TM9311	PA570	TM5126	PA906	TM4106	PA974	TR4174
PA120	TM9112	PA580	TM7580	PA907	TM9707	PA975	TM5102
PA150	TM9102	PA590	TM6559	PA908	TM6508	PA976	TM4176
PA162	TM9316	PA591	TM6659	PA909	TM4709	PA977	TM4977
PA170	TM9117	PA630	TM9163	PA910	TM5119	PA978	TM9366
PA177	TR4777	PA640	TM9164	PA912	TM4112	PA979	TM4179
PA179	TR4779	PA650	TM9165	PA914	TM6547	PA984	TR4784
PA180	TM9118	PA660	TM4760	PA915	TM6522	PA985	TM4185
PA181	TM9318	PA661	TM6261	PA916	TM9706	PA987	TM4187
PA190	TM9790	PA663	TM9306	PA918	TM7918	PA988	TM4188
PA191	TM9191	PA670	TM9167	PA919	TM7919	PA989	TR9189
PA195	TR4795	PA671	TM6667	PA920	TM6519	PA990	TM4990
PA196	TR4796	PA702	TM6670	PA923	TM6345	PA992	TR4792
PA197	TR4797	PA703	TM7370	PA924	TM4124	PA1005	TM9705
PA198	TR4798	PA710	TM7271	PA925	TM4125	PA1007	TM4707
PA211	TM9181	PA720	TM6572	PA926	TM5124	PA1017	TR4717
PA219	TM6719	PA740	TM6521	PA928	TM9528	PA1028	TR6128
PA239	TR4739	PA741	TM7274	PA929	TM9729	PA1038	TM4138
PA240	TM9124	PA750	TM6575	PA943	TM6524	PA1046	TM7102
PA250	TM9502	PA752	TM7275	PA946	TM9170	PA1056	TR4756
PA251	TM4151	PA753	TM6675	PA952	TM6752	PA1059MI	TM7186
PA260	TM9126	PA760	TM6576	PA953	TR4753	PA1060	TR4760
PA270	TM9127	PA770	TM6577	PA955	TR9155	PA1082	TM4782
PA278	TR4778	PA771	TM6571	PA957	TM4157	PPA557	PN6198
PA280	TM9128	PA778	TM6178	PA958	TR4758		
PA290	TM9329	PA700	TM7200	PA959	TR4759		
PA291	TM9391	PA701	TM7270	PA960	TM9166		
PA330	TM9330	PA780	TM7278	PA961	TR4761		
PA340	TM9134	PA790	TM7279	PA963	TM4163		

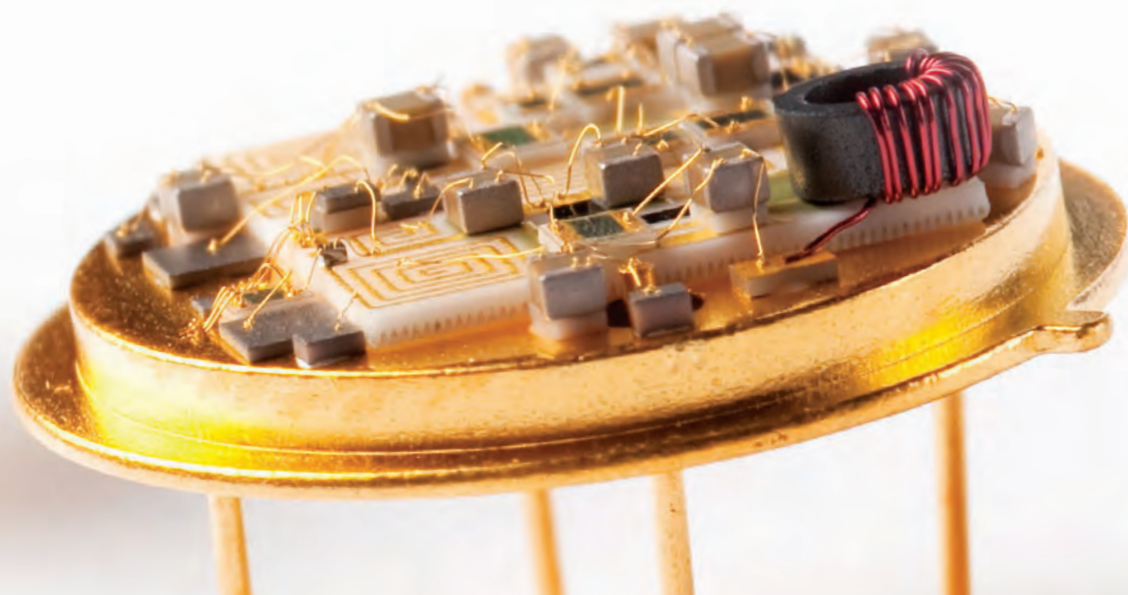

| Filtered GPS LNAs |

API Technologies offers a complete line of Filtered GPS Low Noise Amplifiers, which are ideal for applications where higher reliability is critical. These filtered low noise amplifiers are designed to reduce out-of-band interference while achieving high dynamic range.

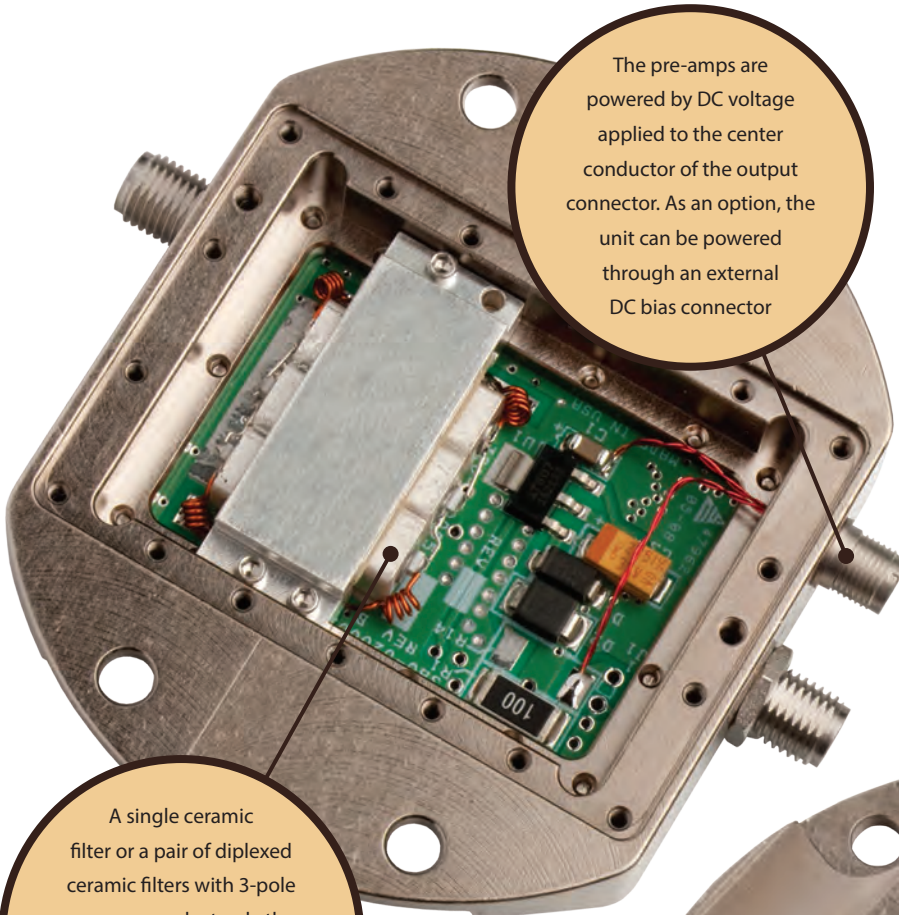

The pre-amps are powered by DC voltage applied to the center conductor of the output connector. As an option, the unit can be powered through an external DC bias connector

- Nickel plated package
- Your choice of SMA, N, or TNC connectors
- Coaxial or External Bias Connection
- Bias options include 5 VDC, 5-16 VDC, and 16-32 VDC
- Custom designs available

The LNAs amplify desired signals by as much as 45 dB.

A single ceramic filter or a pair of diplexed ceramic filters with 3-pole responses, select only the desired GPS signals while the low noise gain stage maintains the receiving system's sensitivity

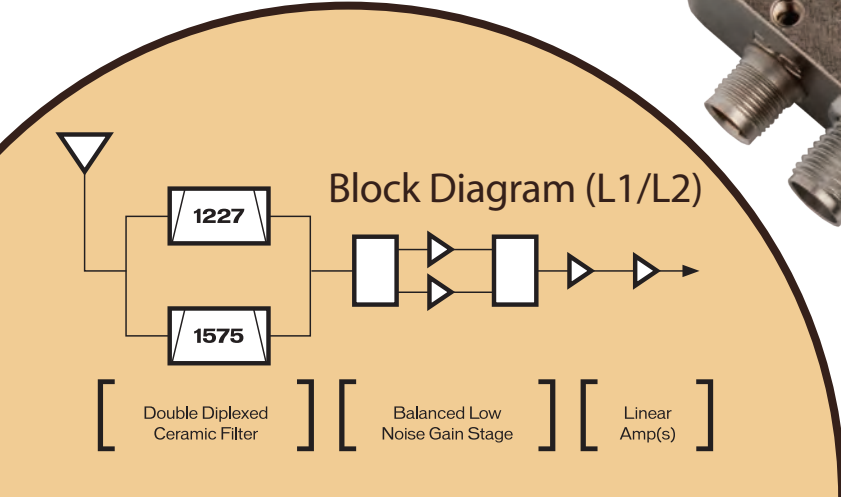
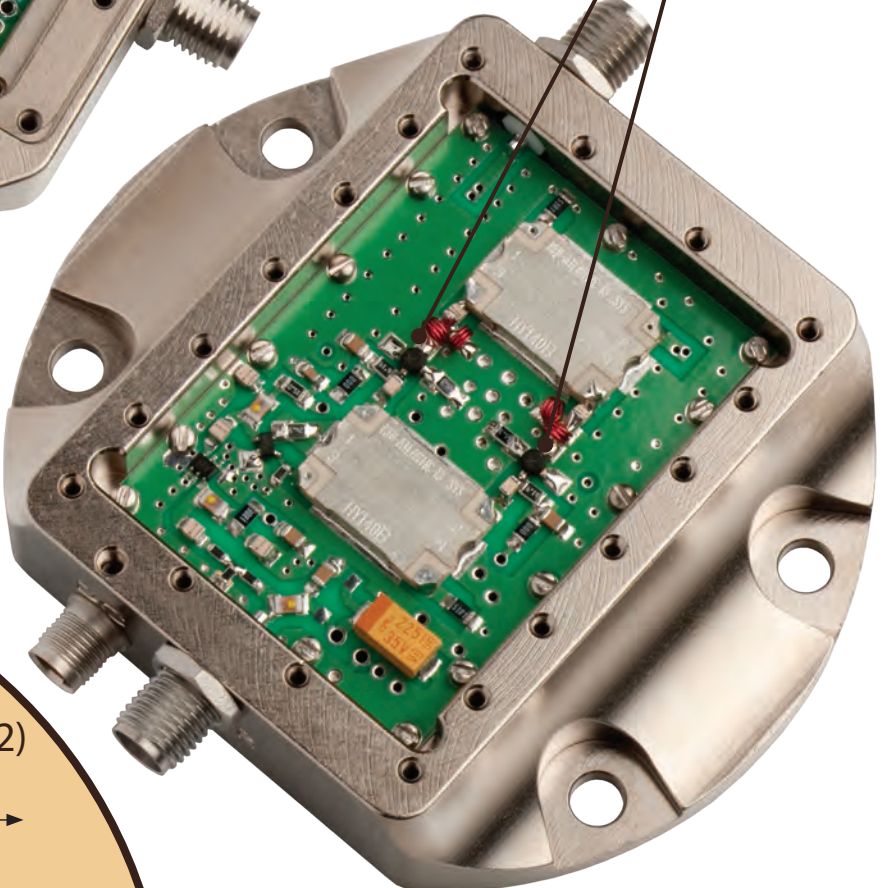

GPS Dual Band (L1 & L2) 5-16 VDC

Model	Frequency	Gain (dB) Min.	Noise Figure (dB) Typ.	VSWR	Bandwidth (MHz)	Bias	DC Power (Volts)	Temperature Range
310-025103-011	1575.42 MHz (L1) 1227.60 MHz (L2)	14	1.6	1.5:1	30	Coaxial Bias	5-16	-40°C to +71°C
310-025103-021	1575.42 MHz (L1) 1227.60 MHz (L2)	14	1.6	1.5:1	30	Ext Bias, MR01	5-16	-40°C to +71°C
310-025105-011	1575.42 MHz (L1) 1227.60 MHz (L2)	26	1.6	1.5:1	30	Coaxial Bias	5-16	-40°C to +71°C
310-025105-021	1575.42 MHz (L1) 1227.60 MHz (L2)	26	1.6	1.5:1	30	Ext Bias, MR01	5-16	-40°C to +71°C
310-025107-011	1575.42 MHz (L1) 1227.60 MHz (L2)	34	1.6	1.5:1	30	Coaxial Bias	5-16	-40°C to +71°C
310-025107-021	1575.42 MHz (L1) 1227.60 MHz (L2)	34	1.6	1.5:1	30	Ext Bias, MR01	5-16	-40°C to +71°C
310-025109-011	1575.42 MHz (L1) 1227.60 MHz (L2)	45	1.6	1.5:1	30	Coaxial Bias	5-16	-40°C to +71°C
310-025109-021	1575.42 MHz (L1) 1227.60 MHz (L2)	45	1.6	1.5:1	30	Ext Bias, MR01	5-16	-40°C to +71°C

GPS Dual Band (L1 & L2) 16-32 VDC

Model	Frequency	Gain (dB) Min.	Noise Figure (dB) Typ.	VSWR	Bandwidth (MHz)	Bias	DC Power (Volts)	Temperature Range
310-025103-012	1575.42 MHz (L1) 1227.60 MHz (L2)	14	1.6	1.5:1	30	Coaxial Bias 5-16	16-32	-40°C to +71°C
310-025103-022	1575.42 MHz (L1) 1227.60 MHz (L2)	14	1.6	1.5:1	30	Ext Bias, MR01	16-32	-40°C to +71°C
310-025105-012	1575.42 MHz (L1) 1227.60 MHz (L2)	26	1.6	1.5:1	30	Coaxial Bias 5-16	16-32	-40°C to +71°C
310-025105-022	1575.42 MHz (L1) 1227.60 MHz (L2)	26	1.6	1.5:1	30	Ext Bias, MR01	16-32	-40°C to +71°C
310-025107-012	1575.42 MHz (L1) 1227.60 MHz (L2)	34	1.6	1.5:1	30	Coaxial Bias 5-16	16-32	-40°C to +71°C
310-025107-022	1575.42 MHz (L1) 1227.60 MHz (L2)	34	1.6	1.5:1	30	Ext Bias, MR01	16-32	-40°C to +71°C
310-025109-012	1575.42 MHz (L1) 1227.60 MHz (L2)	45	1.6	1.5:1	30	Coaxial Bias 5-16	16-32	-40°C to +71°C
310-025109-022	1575.42 MHz (L1) 1227.60 MHz (L2)	45	1.6	1.5:1	30	Ext Bias, MR01	16-32	-40°C to +71°C

Best Dynamic Range

These designs exhibit excellent anti-jam performance by delivering excellent filtering of interference while delivering the best dynamic range possible.

Amplifier Gain (L1/L2)

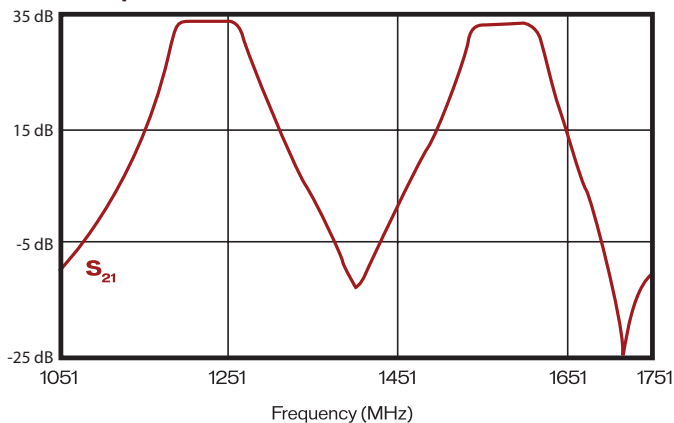

Return Loss (L1/L2)

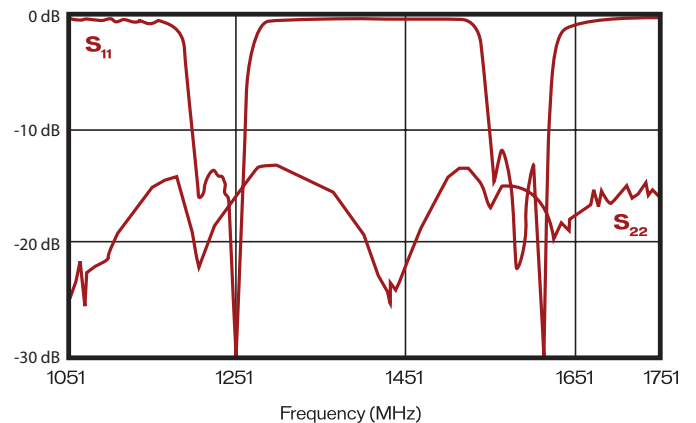

| Higher Frequency Amplifiers |

From S-band through K-band, API Technologies designs higher frequency amplifiers to meet a wide variety of applications. From ultra broadband 2-26 GHz designs to custom low noise Ku-band amps, our engineers draw from the latest semiconductor advances in order to offer both extended frequency and higher performance in one package.

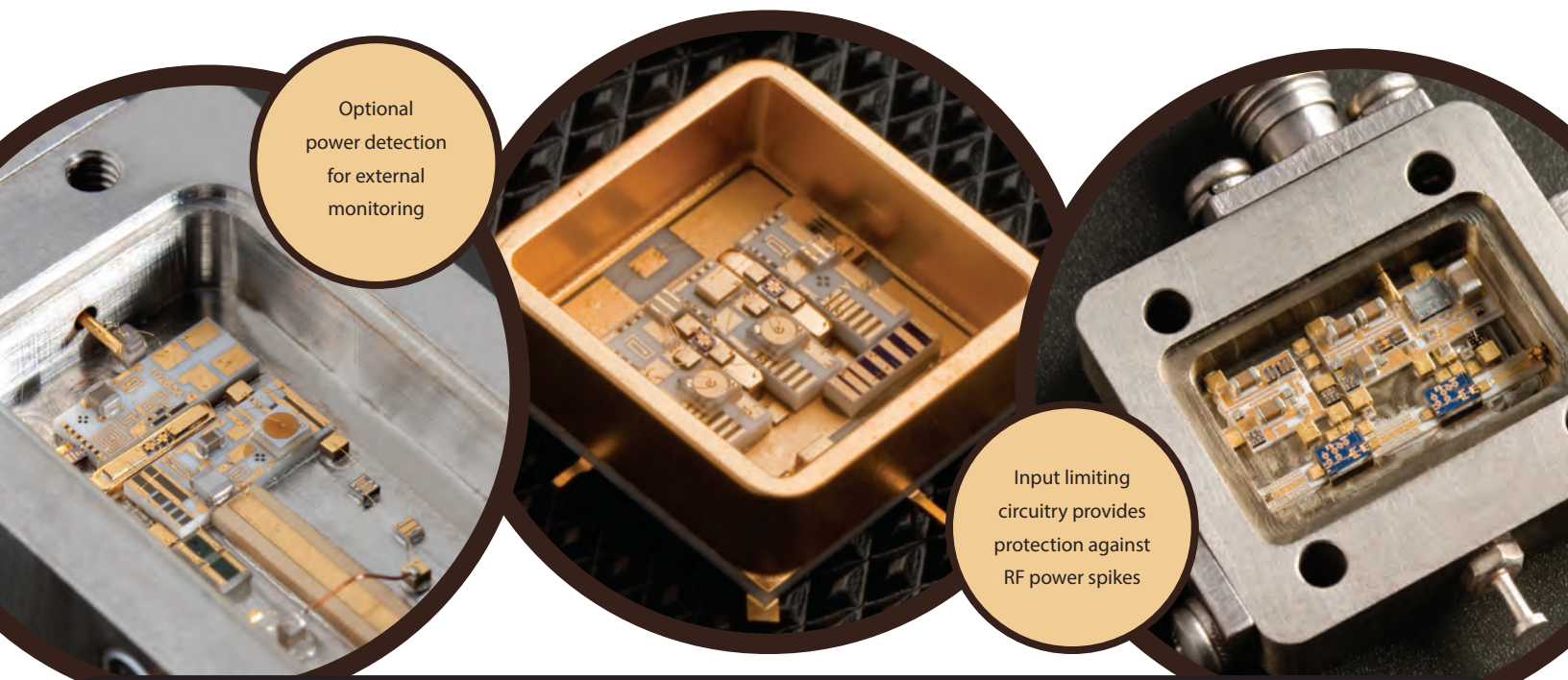

Higher Frequency Amplifiers

Model	Frequency (GHz)	Gain (dB)	P1dB (dBm)	N.F. (dB)	Input VSWR	Output VSWR	OIP3 (dBm)	Supply (+DC/mA)
QB-967	0.02 - 4	15	21	4.8	1.4	1.6	32	12 V / 255 mA
TM9479	0.1 - 4	8.3	22	4.8	1.4	1.4	36	15 V / 115 mA
TM9486	0.1 - 4	20	20.5	3.8	1.6	1.8	30	15 V / 60 mA
QBH-4033	2 - 4	15.5	21	1.6	1.4	1.4	33	12 V / 92 mA
QB-9356	2 - 4	30	21	1.7	1.6	1.6	32	12 V / 180 mA
QBH-5403	3 - 4	15	20	1.7	1.5	1.2	31	8 V / 85 mA
TM9200	0.1 - 4.2	12	16	4	2.7	1.8	33	5 V / 75 mA
QB-943	3.5 - 4.5	30	25	3	1.4	1.3	35	15 V / 450 mA
QB-944	3.5 - 4.5	34	27	3	1.4	1.3	37	15 V / 550 mA
QB-956	0.3 - 4.8	30	25	3	1.4	1.3	35	15 V / 420 mA
QBH-5729	1 - 6	15.5	21	5	1.7	1.7	31	15 V / 135 mA
QB-910	2 - 6	27	27 (Psat)	-	1.9	1.7	-	24 V / Class AB
QB-904	2 - 6	38	35 (Psat)	-	1.9	1.7	-	24 V / Class AB
QB-919	4 - 8	7.5	20	5	1.5	1.5	30	12 V / 110 mA
QB-917	4 - 8	16	17	1.8	1.5	1.5	23	12 V / 55 mA
QB-920	4 - 8	22.5	20	2	1.5	1.5	25	12 V / 165 mA
QB-921	4 - 8	32	17	1.8	1.5	1.5	23	12 V / 110 mA
QB-922	4 - 8	40	20	1.8	1.5	1.5	25	12 V / 220 mA
QB-957	8.5 - 9.5	7	21	4.9	1.3	1.3	31	12 V / 130 mA
QB-958	8.5 - 9.5	20	19	6.6	1.4	1.3	31	5 V / 121 mA
QB-959	8.5 - 9.5	22	13	2	1.5	1.5	25	5 V / 125 mA
QB-969	0.5 - 10	15	20	4	2.0	2.0	30	10 V / 200 mA
QB-947	6 - 12	22.5	9	3	1.4	1.7	20	9 V / 96 mA
QB-972	10 - 12	20	19	7	1.5	1.5	30	5 V / 125 mA
QB-968	2 - 18	24	15	5	1.7	1.7	25	12 V / 150 mA
QB-945	19 - 27	45	28	4.5	1.7	1.7	36	12 V / 800 mA

All specifications listed are typical at 25°C



Adding value to our line of high frequency amplifiers:

- Voltage Regulators
- Integral Analog Detectors
- Power Limiters
- Temperature compensating circuitry
- Custom Designs Available

Full Performance Amps

Part Number	Frequency (MHz)	Gain (dB)	P1dB (dBm)	N.F. (dB)	IP3 (dBm)	IP2 (dBm)	Rev. Iso. (dB)	Input VSWR	Output VSWR	Supply (+DC/mA)
TM3051	0.5 - 80	14	16.5	4.5	31	41	20	2	1.5	15 V / 62.5 mA
QB-102	2 - 32	12.2	28	6.2	50	100	23	1.5	1.5	24 V / 400 mA
QB-111	1 - 33	18	29	5	52	110	29	1.5	1.5	24 V / 425 mA
QB-188	0.5 - 100	15	22	3	40	55	35	1.6	1.6	15 V / 85 mA
QB-312	0.5 - 32	12.7	29	8	50	100	40	1.5	1.5	24 V / 450 mA
QB-411	2 - 55	21.6	29	4.5	55	110	30	1.2	1.2	24 V / 400 mA
QB-188	0.5 - 100	15	21	3	37	47	28	1.5	1.5	15 V / 100 mA
QBH-172	1 - 100	15	16	3.3	31	45	27	1.5	1.5	15 V / 51 mA
QBH-118	3 - 100	16.3	11	1.9	26	38	35	1.5	1.5	15 V / 21 mA
TM5118	3 - 100	16.3	6.5	1.5	19	25	28	1.75	1.25	15 V / 21 mA
QBH-845	3 - 100	17	16	1.9	29	43	34	1.5	1.5	15 V / 30 mA
QBH-117	5 - 100	16.5	4.5	1.5	17	24	35	1.5	1.5	15 V / 11 mA
TM5841	5 - 100	19	4.5	1.5	17	24	33	1.5	1.8	15 V / 13 mA
QBH-124	5 - 100	19.8	17	3.5	30	40	32	1.5	1.5	15 V / 60 mA
TM6162	10 - 100	12.5	16	1.4	32	46	15	1.5	1.5	15 V / 13.5 mA
TM7111	10 - 100	12.5	17	1.4	33	47	15	1.8	1.8	15 V / 14 mA
QBH-125	10 - 100	19.6	23	4.5	38	50	29	1.5	1.5	15 V / 132 mA
QBH-834	10 - 100	19.7	27	5.5	37	47	26	1.5	1.5	15 V / 135 mA
TM5834	10 - 100	19.7	27.5	3.5	40	52	25	1.7	1.3	15 V / 135 mA
QBH-804	10 - 100	19.8	24	4	38	48	27	1.5	1.5	15 V / 82 mA
QBH-854	10 - 100	20	24	4	38	48	27	1.5	1.5	15 V / 82 mA
TM5125	10 - 100	20.5	24	2	40	52	24	1.7	1.4	15 V / 80 mA
TM5325	10 - 100	20.5	24	2	40	52	24	1.7	1.4	12 V / 85 mA
TM3009	30 - 100	17	13.5	3.75	27	41	20	1.25	1.25	5 V / 28 mA
TM3008	30 - 100	17.2	16	2	32	40	20	1.2	1.5	12 V / 37.5 mA
TM3028	40 - 100	20.5	24	2.2	38	51	25	1.75	1.45	15 V / 82 mA
TR3054	40 - 100	24	10.5	1.65	20	30	15	1.5	1.5	15 V / 45 mA
TM3036	25 - 110	20.5	25.5	2.5	40	50	25	1.75	1.75	15 V / 102 mA
TM3035	80 - 120	16	28.5	3	45	50	22	1.9	1.25	11 V / 200 mA
TM3045	5 - 125	15	16	2	29	39	18	1.35	1.35	12 V / 29 mA
TM5338	5 - 150	15	25	2.7	36	44	20	1.5	1.3	12 V / 88 mA
QBH-138	5 - 150	15.5	20	3.2	37	49	28	1.6	1.6	15 V / 99 mA
TM5138	5 - 150	15.5	23	3.1	38	46	27	1.6	1.6	15 V / 90 mA
TM5149	5 - 150	23.5	18	3	33	37	29	1.5	1.5	15 V / 35 mA
TM7104	5 - 150	24	12	1.9	25	31	27	1.75	1.75	5 V / 20 mA
QBH-180	5 - 150	29	18	3.8	31	42	45	1.6	1.6	15 V / 59 mA
QBH-280	5 - 150	29	18	3.8	31	42	46	1.6	1.6	15 V / 59 mA
TM5180	5 - 150	29	18	3.8	32	42	36	1.6	1.6	15 V / 59 mA
QBH-145	10 - 150	13	19	5.8	34	47	31	1.5	1.5	15 V / 42 mA
TM5145	10 - 150	13	17.5	5.8	34	46	32	1.2	1.4	15 V / 47 mA
QBH-261	10 - 150	13.3	27	4.2	43	55	16	2	2	15 V / 175 mA
QBH-171	10 - 150	13.5	27	7	40	50	25	1.5	1.5	15 V / 105 mA
QBH-271	10 - 150	13.5	27	6.5	39	45	26	1.5	1.5	15 V / 105 mA
QBH-149	10 - 150	23	17.5	3.2	29	39	30	1.5	1.5	15 V / 39 mA
TM7103	10 - 150	26.5	9.5	2.3	23	28	31	1.4	1.4	5 V / 15.5 mA
TM7101	10 - 150	27.5	16.5	1.8	30	35	31	1.5	1.25	15 V / 20 mA
TM5171	20 - 150	13.5	27	6.5	39	50	25	1.5	1.5	15 V / 105 mA
TM7102	20 - 150	24.5	17	2	29	40	28	1.5	1.5	15 V / 31 mA
TM3089	10 - 160	20	24.5	2.5	40	52	22	1.8	1.8	15 V / 110 mA
TM3026	50 - 160	14.5	28	5	40	48	17	1.5	1.5	24 V / 170 mA
TZ9211	0.1 - 200	27.5	16	5.2	28	40	41	1.25	1.25	15 V / 90 mA
TZ9210	0.1 - 200	29	7	4.5	19	33	41	1.25	1.5	15 V / 35 mA
TZ9212	0.1 - 200	31.5	7	3.5	17	33	41	1.5	1.5	15 V / 35 mA
TZ9216	5 - 200	12.5	15.5	5.5	30	41	21	1.25	1.5	15 V / 50 mA
CZ8205	5 - 200	13.5	21	6	25	35	20	1.75	1.75	15 V / 95 mA
TM7379	5 - 200	14	23	4.5	38	47	16	1.5	1.5	12 V / 88 mA
TZ9214	5 - 200	14	21	6.5	34	44	20	1.5	1.75	15 V / 95 mA
CZ8208	5 - 200	14.5	12.5	5	26	40	22	1.3	1.3	13 V / 36 mA
CZ8207	5 - 200	18	4	4	15	23	25	1.25	1.5	5 V / 17 mA
QBH-304	5 - 200	19.5	8.5	3	20	26	32	1.5	1.5	15 V / 24 mA
TM5304	5 - 200	19.5	10.5	2.5	25	33	26	1.75	1.5	15 V / 24 mA
CZ8203	5 - 200	20	9.5	6	21	45	38	1.25	1.25	15 V / 62 mA
TZ9205	5 - 200	20.5	14.5	6	28	44	36	1.25	1.25	15 V / 90 mA
TZ9204	5 - 200	20.8	6.5	6	18	35	34	1.25	1.25	15 V / 37 mA

Full Performance Amps

Part Number	Frequency (MHz)	Gain (dB)	P1dB (dBm)	N.F. (dB)	IP3 (dBm)	IP2 (dBm)	Rev. Iso. (dB)	Input VSWR	Output VSWR	Supply (+DC/mA)
TZ9206	5 - 200	24	7.5	4.5	18	34	35	1.5	1.25	15 V / 37 mA
CZ8251	5 - 200	26.5	3	4	14	27	43	1.4	1.25	5 V / 30 mA
TZ9208	5 - 200	27.5	15.5	5	28	44	42	1.25	1.5	12 V / 90 mA
TM3065	5 - 200	28	15	5.5	30	52	34	1.75	1.5	15 V / 63 mA
TZ9202	5 - 200	28.5	16.5	5.25	28	44	40	1.25	1.5	15 V / 90 mA
TZ9207	5 - 200	28.5	8	5	20	33	41	1.25	1.5	12 V / 38 mA
TZ9201	5 - 200	29.5	8	5	19	34	40	1.25	1.5	15 V / 35 mA
TZ9209	5 - 200	30.5	7	3.5	18	28	40	1.5	1.5	12 V / 36 mA
TR7215	5 - 200	31.5	13	2.5	26	39	40	1.1	1.25	15 V / 58 mA
TZ9203	5 - 200	31.5	7.5	3.5	19	35	40	1.5	1.5	15 V / 35 mA
CZ8201	5 - 200	32	5.75	3.25	16	43	42	1.7	1.75	15 V / 30 mA
CZ8202	5 - 200	32	5.75	3.25	23	40	42	1.7	1.75	15 V / 55 mA
CZ8206	5 - 200	32	3.5	3.5	15	32	42	1.75	1.75	12 V / 30 mA
TM3046	5 - 200	32	3	3	16	26	42	1.25	1.5	5 V / 30 mA
TM6118	10 - 200	10	18	1.5	33	55	12	1.2	1.2	15 V / 18 mA
QBH-237	10 - 200	12.5	20	3.5	38	50	25	1.5	1.5	15 V / 94 mA
QBH-137	10 - 200	12.7	21	3.5	37	48	25	1.5	1.5	15 V / 94 mA
TM5137	10 - 200	12.7	22.5	3.5	39	53	18	1.6	1.8	15 V / 75 mA
TM7272	10 - 200	14.7	14	3	29	41	18	1.15	1.15	5 V / 35 mA
TM6112	10 - 200	16.4	14.5	2	28	38	20	1.5	1.25	15 V / 27 mA
QBH-136	10 - 200	20	21	4.5	33	42	26	1.5	1.5	15 V / 70 mA
TM5136	10 - 200	20	21	4	33	45	26	1.5	1.5	15 V / 70 mA
TM7205	10 - 200	20	14	1.6	21	26	24	1.8	1.6	5 V / 18 mA
QBH-181	10 - 200	24.4	16	2.8	25	36	31	1.5	1.5	15 V / 33 mA
TM7380	10 - 200	27.5	17	2.2	31	35	32	1.75	1.75	15 V / 28 mA
TM7286	10 - 200	28	8	2.5	20	28	38	1.75	1.75	5 V / 21 mA
QBH-870	10 - 200	7.9	20	3.2	36	49	10	1.5	1.5	15 V / 31 mA
TM7210	10 - 200	9	14	1.3	31	48	11	1.5	1.35	15 V / 15 mA
TM3090	15 - 200	14	19	1.75	35	47	20	1.5	1.5	10 V / 55 mA
TM3091	15 - 200	14	23.5	1.7	36	43	21	1.5	1.5	10 V / 85 mA
TM6121	20 - 200	10	20	2.5	38	55	18	1.8	1.8	15 V / 60 mA
TM6334	20 - 200	14	26	3.5	41	50	20	1.8	1.8	12 V / 95 mA
TM6134	20 - 200	14.3	26	4	39	54	17	1.6	1.4	15 V / 90 mA
TM3087	20 - 200	16	25	3	41	47	17	1.75	1.75	12 V / 85 mA
TM5124	20 - 200	20.5	20	2.5	34	44	24	1.5	1.2	15 V / 53 mA
TM7221	20 - 200	28.5	18.5	2	33	38	31	1.5	1.4	15 V / 29 mA
TM7222	20 - 200	29	20.5	2.9	32	38	34	1.8	1.8	15 V / 47 mA
TM6514	30 - 200	16.5	-2	2	11	11	20	1.4	1.2	15 V / 8 mA
TM7211	30 - 200	8.5	20	1.8	40	55	12	1.8	1.4	15 V / 30 mA
TM7212	30 - 200	8.5	20	1.8	40	55	12	1.75	1.35	12 V / 30 mA
TM3082	50 - 200	13	15	1.5	27	35	21	1.7	1.7	5 V / 35 mA
TM3024	100 - 200	16.5	13	1.75	27	38	18	1.3	1.5	15 V / 23 mA
TM3023	100 - 200	29	12.5	1.8	24	26	33	1.25	1.6	15 V / 15 mA
TM3006	100 - 200	30	18	3	31	48	35	1.3	1.3	12 V / 72 mA
TM3039	100 - 220	18	22	2.5	39	53	19	1.5	1.5	12 V / 80 mA
TM7277	5 - 250	10.5	24	4	41	48	12	1.5	1.8	15 V / 70 mA
TM7279	5 - 250	14	23	4.5	36	46	15	1.5	1.5	15 V / 88 mA
TM7271	5 - 250	18	0.5	1.5	10	13	23	1.3	1.3	15 V / 9 mA
TM7371	5 - 250	18	2	1.75	14	15	21	1.25	1.25	15 V / 9 mA
TM3011	5 - 250	18.5	22	4.2	36	43	20	1.75	1.5	15 V / 80 mA
TM7275	5 - 250	20.5	9.5	2.5	22	27	25	1.5	1.75	15 V / 24 mA
TM7288	5 - 250	22	7.5	1.8	20	23	23	1.25	1.25	15 V / 18 mA
TM7208	5 - 250	22.5	3	1.4	16	13	25	1.5	1.25	15 V / 10 mA
TM7202	5 - 250	27	16.5	5	29	38	38	1.5	1.5	15 V / 88 mA
TM7201	5 - 250	29	7	5	19	30	40	1.25	1.4	15 V / 35 mA
TM7203	5 - 250	32	8	3	18	30	40	1.75	1.75	15 V / 35 mA
TM6117	5 - 250	8.2	10	1.3	28	43	11	1.25	1.25	15 V / 12 mA
TM3017	7 - 250	15	12.5	2	25	34	19	1.5	1.75	10 V / 20 mA
TM3050	10 - 250	10.5	28	4.5	43	68	17	1.5	1.75	15 V / 210 mA
QBH-842	10 - 250	13.5	26	6.5	40	48	24	1.5	1.8	15 V / 122 mA
TM4172	10 - 250	13.5	23	3	35	43	20	1.6	1.6	12 V / 90 mA
TM3016	10 - 250	29	16	2.3	28	34	44	1.5	1.25	15 V / 62 mA
TM6683	10 - 250	34	-1	2	10	9	47	1.8	1.8	5 V / 14 mA
TM6670	10 - 250	8	20	1.8	36	46	11	1.5	1.5	15 V / 25 mA

*All specifications listed are typical at 25°C.

Full Performance Amps

Part Number	Frequency (MHz)	Gain (dB)	P1dB (dBm)	N.F. (dB)	IP3 (dBm)	IP2 (dBm)	Rev. Iso. (dB)	Input VSWR	Output VSWR	Supply (+DC/mA)
TM7570	10 - 250	8	13	1.4	30	50	10	1.5	1.3	5 V / 15 mA
TM7270	10 - 250	8.3	13	1.4	30	50	10	1.5	1.3	15 V / 15 mA
TM7170	10 - 250	8.5	10	1.5	26	38	9	1.75	1.5	15 V / 11.5 mA
TM7382	20 - 250	18	17.5	4	29	31	32	1.5	1.2	15 V / 45 mA
TM7282	20 - 250	23.5	21	4	34	38	28	1.5	1.5	15 V / 45 mA
TM7381	20 - 250	24.5	14.5	2.2	27	32	31	1.35	1.5	15 V / 18 mA
TM7281	20 - 250	25.5	17.5	2.4	31	35	32	1.5	1.8	15 V / 30 mA
TM5670	20 - 250	8.2	15.5	2	28	33	11	1.35	1.2	5 V / 25 mA
TM7370	20 - 250	8.5	23	1.9	40	49	11	1.25	1.35	15 V / 45 mA
TM6119	30 - 250	8	23	3	36	45	13	1.7	1.5	15 V / 43 mA
TM3040	100 - 250	14.5	27	4	39	54	22	1.6	1.35	15 V / 110 mA
CZ8451	1 - 300	17	2.5	2.25	14	15	21	1.5	1.5	5 V / 12.5 mA
QB-300	1 - 300	24.5	22	3.8	37	52	36	1.5	1.5	20 V / 154 mA
QBH-103	5 - 300	11.3	22	6.8	37	51	22	1.5	1.5	15 V / 91 mA
TM5103	5 - 300	11.5	23	5	36	45	14	1.3	1.3	15 V / 85 mA
TM5105	5 - 300	12	7	2.75	21	29	18	1.5	1.6	15 V / 17 mA
QBH-105	5 - 300	12.2	8	3	22	30	27	1.5	1.5	15 V / 18 mA
TM7147	5 - 300	12.5	15.5	2.1	31	46	15	1.2	1.2	5 V / 36 mA
TM7278	5 - 300	13.5	21.5	4	36	49	15	1.3	1.5	15 V / 65 mA
TM7347	5 - 300	13.5	16	2	32	44	22	1.5	1.5	15 V / 45 mA
QBH-155	5 - 300	15	22	6.2	37	50	26	1.5	1.5	15 V / 93 mA
TM5155	5 - 300	15	22	5	37	48	17	1.8	1.8	15 V / 85 mA
TM3066	5 - 300	29	18	1.75	32	39	35	1.3	1.5	15 V / 80 mA
TM7274	5 - 300	31	9.5	3	21	32	38	1.5	1.75	15 V / 40 mA
QBH-851	10 - 300	10	20	4	38	54	15	1.7	1.5	15 V / 90 mA
QBH-223	10 - 300	11.5	21	6.3	36	50	25	1.5	1.5	15 V / 94 mA
TM7302	10 - 300	11.8	25	6	38	50	16	1.7	1.7	24 V / 100 mA
TM3072	10 - 300	13.5	27.5	5	44	60	17	1.5	1.5	15 V / 180 mA
TM3097	10 - 300	13.5	27.5	5	44	55	17	1.5	1.5	12 V / 180 mA
TM6656	10 - 300	14	27	4.5	40	51	16	1.5	1.5	15 V / 180 mA
TM7287	10 - 300	15.5	10	2.75	24	33	20	1.5	1.25	5 V / 14.5 mA
TM7487	10 - 300	15.5	8	3	22	30	20	1.5	1.5	5 V / 13 mA
TM3041	10 - 300	16.5	24	2.8	38	50	20	1.8	1.8	15 V / 80 mA
QBH-152	10 - 300	17	18	3.9	33	46	26	1.5	1.6	15 V / 79 mA
TM5152	10 - 300	17	20	3.5	33	47	20	1.8	1.5	15 V / 55 mA
TM5352	10 - 300	17	18	3.5	33	47	26	1.5	1.5	12 V / 68 mA
TM7207	10 - 300	18	16	2	31	42	21	1.7	1.7	15 V / 33 mA
QBH-150	10 - 300	20	18	3.9	30	40	25	1.5	2	15 V / 46 mA
QBH-250	10 - 300	20	18	3.5	30	41	23	1.5	2	15 V / 51 mA
TM5150	10 - 300	20	18	2.5	32	43	23	1.8	1.5	15 V / 47 mA
TM9731	10 - 300	22	24	3.5	35	45	37	1.7	1.7	15 V / 130 mA
TR3084	10 - 300	27	29	4	40	50	34	1.5	1.5	15 V / 280 mA
TM6610	10 - 300	8	20	1.8	36	46	11	1.5	1.5	10 V / 25 mA
TM7481	15 - 300	28	16.5	2.3	29	33	32	1.8	1.8	15 V / 27 mA
TM3038	20 - 300	10.5	16.5	4.5	29	33	17	1.5	1.5	5 V / 43 mA
TR5853	100 - 300	33.5	22.5	1.8	36	45	37	1.75	1.75	15 V / 87 mA
TR3044	200 - 300	32	21	1.8	33	45	37	1.4	1.4	15 V / 90 mA
TM7291	5 - 350	24	19	3	31	40	28	1.5	1.4	15 V / 28 mA
CZ8454	5 - 350	27	4	3.8	16	28	43	1.5	1.5	5 V / 32 mA
TM7148	10 - 350	13.5	25	3.2	42	57	17	1.5	1.5	15 V / 108 mA
CZ8010	kHz - 400	14	-3	3	21	32	15	1.5	1.5	3 V / 25 mA
CZ8020	kHz - 400	14	7	4.5	21	32	15	1.5	2	5 V / 25 mA
CZ8030	kHz - 400	14	16	6	21	32	15	1.5	1.5	5 V / 25 mA
CZ8462	kHz - 400	14.5	8.5	5	20	33	20	1.75	1.75	15 V / 25 mA
CZ8111	kHz - 400	15	-2	2.8	12	11	17	1.6	2	1.8 V / 10 mA
CZ8120	kHz - 400	15	9	5	21	25	18	2	2.2	5 V / 25 mA
CZ8040	kHz - 400	19	9.5	3.8	21	26	21	2	2.2	3.5 V / 25 mA
CZ8130	0.01 - 400	14	18	6	30	40	20	2.25	2	5.7 V / 60 mA
CZ8110	0.01 - 400	15	-0.2	4	10	8	19	1.5	2	3 V / 10 mA
BXMP1023	1 - 400	10.5	17	6.5	30	39	17	1.5	1.75	15 V / 65 mA
CZ8463	1 - 400	10.5	17	6.5	30	36	15	1.5	1.75	24 V / 62 mA
CZ8464	1 - 400	10.5	17	6.5	30	39	17	1.5	1.75	15 V / 65 mA
CZ8460	1 - 400	15	-1.5	3.3	11	10	20	1.5	1.75	15 V / 10 mA
CZ8461	1 - 400	15	-1.5	4.5	11	9	21	1.5	1.75	15 V / 10 mA

Full Performance Amps

Part Number	Frequency (MHz)	Gain (dB)	P1dB (dBm)	N.F. (dB)	IP3 (dBm)	IP2 (dBm)	Rev. Iso. (dB)	Input VSWR	Output VSWR	Supply (+DC/mA)
CZ8403	5 - 400	10.5	17	6.8	30	42	15	1.5	1.75	24 V / 62 mA
CZ8404	5 - 400	11	17	6.5	30	45	17	1.5	1.75	15 V / 65 mA
TZ9403	5 - 400	11	17	6.5	30	38	15	1.5	1.75	24 V / 62 mA
TZ9404	5 - 400	11	17	6.5	30	38	17	1.75	1.75	15 V / 65 mA
QBH-116	5 - 400	12.2	16	6	29	38	25	1.5	1.5	15 V / 47 mA
TZ9409	5 - 400	12.5	14.5	5.5	26	38	21	1.75	2	15 V / 50 mA
TZ9405	5 - 400	13.5	20	6.5	35	42	19	1.5	1.75	15 V / 90 mA
TZ9400	5 - 400	14	-4	3.5	10	5	20	1.5	2	15 V / 8 mA
TZ9401	5 - 400	14.7	-1	4.5	11	13	20	1.5	1.9	15 V / 10 mA
CZ8402	5 - 400	15	9	4.75	20	33	21	1.5	1.65	15 V / 25 mA
TM6457	5 - 400	15	10	2	24	35	19	1.5	1.7	5 V / 15.5 mA
TZ9402	5 - 400	15	8.5	5	21	27	20	1.5	1.75	15 V / 25 mA
TZ9411	5 - 400	15	0.5	4.5	13	15	20	1.25	1.75	12 V / 12 mA
CZ8405	5 - 400	16	20.5	5.5	32	40	20	1.75	1.75	15 V / 90 mA
TM6556	5 - 400	26	14	4.5	28	47	35	1.5	1.5	15 V / 66 mA
TM6554	5 - 400	27.5	8	5	19	32	35	1.5	1.5	15 V / 33 mA
TZ9408	5 - 400	28	10.5	5	22	34	35	1.25	1.6	15 V / 45 mA
TZ9416	5 - 400	28	-3.4	4	9	11	40	1.25	1.5	15 V / 20 mA
TM6421	5 - 400	30	9	3.5	22	36	36	1.35	1.65	15 V / 37 mA
TM6440	10 - 400	13	9	3.6	23	33	18	1.5	1.75	15 V / 15 mA
TM6444	10 - 400	13	11	4	25	37	18	1.5	1.5	5 V / 15 mA
TM6587	10 - 400	13	17	4	32	47	19	1.75	1.75	15 V / 32 mA
TM6443	10 - 400	13.2	6.5	3.5	19	27	17	1.5	1.75	5 V / 10 mA
TM4179	10 - 400	14.5	26.5	4	38	48	16	1.5	1.5	15 V / 130 mA
TM5441	10 - 400	14.5	15	3.8	25	33	20	1.25	1.6	5 V / 33 mA
TM6487	10 - 400	15.5	17.5	3.2	32	45	20	1.5	1.7	15 V / 33 mA
TM7388	10 - 400	15.5	23	4.5	37	45	19	1.5	1.5	15 V / 70 mA
TR9189	10 - 400	23	25.5	5	35	45	32	1.8	1.8	15 V / 205 mA
TR9190	10 - 400	23	25.5	5	35	45	32	1.8	1.8	12 V / 205 mA
TR6535	10 - 400	32.5	22	1.8	37	48	36	1.75	1.5	15 V / 90 mA
TM6181	10 - 400	8.5	8	1.7	23	40	10	1.15	1.2	15 V / 11 mA
TM6442	20 - 400	14	22	4.5	37	51	19	1.1	1.3	15 V / 62 mA
TM6441	20 - 400	14.5	16	3.5	31	48	19	1.5	1.8	15 V / 32 mA
TM3025	100 - 400	14	22	4	35	50	15	1.75	1.75	12 V / 95 mA
TM3032	100 - 400	16.5	9.5	2	22	29	19	1.75	1.75	15 V / 16 mA
TM9705	225 - 400	15	23	1.5	34	44	21	1.7	1.7	15 V / 90 mA
TM3056	225 - 400	18.5	15	1.5	33	41	34	1.75	1.75	15 V / 46 mA
TM3004	225 - 400	22.8	6.5	1.8	18	20	26	1.25	1.25	15 V / 15 mA
TM6588	5 - 450	18.5	21	4.5	35	44	20	1.75	1.5	15 V / 80 mA
TM5198	5 - 450	28	13	3	25	38	36	1.3	1.3	5 V / 47 mA
TR6476	10 - 450	29	16	2.7	29	33	23	1.5	1.4	8 V / 65 mA
TM3005	100 - 450	16	13	1.8	27	39	19	1.75	1.75	15 V / 25 mA
TM3012	200 - 450	22	14	3.2	27	36	23	1.5	1.5	12 V / 33 mA
TM6603	5 - 500	10	15.5	5.5	30	42	15	1.5	1.5	24 V / 50 mA
TM6655	5 - 500	11	22	5.5	36	46	15	1.5	1.5	15 V / 88 mA
TM6559	5 - 500	11.5	22	5.5	36	46	15	1.5	1.5	15 V / 88 mA
TM6609	5 - 500	11.5	22	5.5	36	46	15	1.5	1.5	24 V / 88 mA
TM6558	5 - 500	12	19	4.8	36	48	16	1.5	1.5	15 V / 65 mA
QBH-102	5 - 500	12.3	21	7	34	49	23	1.5	1.5	15 V / 93 mA
TM5102	5 - 500	12.5	22	5.5	36	46	16	1.5	1.5	15 V / 88 mA
TM6515	5 - 500	12.5	16.5	4.5	31	43	16	1.5	1.5	15 V / 50 mA
QBH-101	5 - 500	13	7	2.4	20	28	23	1.5	1.5	15 V / 18 mA
TM5101	5 - 500	13	7.5	2.75	21	31	15	1.25	1.4	15 V / 17 mA
TM6518	5 - 500	14	25	5	33	40	13	1.6	1.7	15 V / 125 mA
TM6012	5 - 500	14.5	23	4.6	36	50	18	1.4	1.2	12 V / 88 mA
TM6203	5 - 500	14.5	25	5	37	45	14	1.75	1.75	15 V / 125 mA
TM6509	5 - 500	14.5	23	4.6	36	50	18	1.4	1.2	15 V / 88 mA
TM6516	5 - 500	14.5	14	4	28	38	17	1.4	1.25	15 V / 35 mA
TM6520	5 - 500	14.5	13	3.5	27	34	17	1.3	1.5	5 V / 33 mA
TM6555	5 - 500	14.7	11.5	4	24	35	18	1.15	1.25	15 V / 33 mA
TM6572	5 - 500	14.7	13	4	27	38	18	1.25	1.25	5 V / 30 mA
TM6672	5 - 500	14.7	13	4	27	38	18	1.25	1.25	9 V / 30 mA
QBH-110	5 - 500	15	9	3	23	33	25	1.5	1.5	15 V / 29 mA
QBH-119	5 - 500	15	12	3	26	36	25	1.5	1.5	15 V / 33 mA

*All specifications listed are typical at 25°C.

Higher Level Solutions

API Technologies designs, also plays a leading role in amplifier based solutions and subsystems. From harmonically filtered, HF/VHF/UHF power amplifiers to complex, integrated, software configured, amplifier assemblies for receive and transmit applications, we continue to provide enhanced amplifier solutions to major markets around the world.

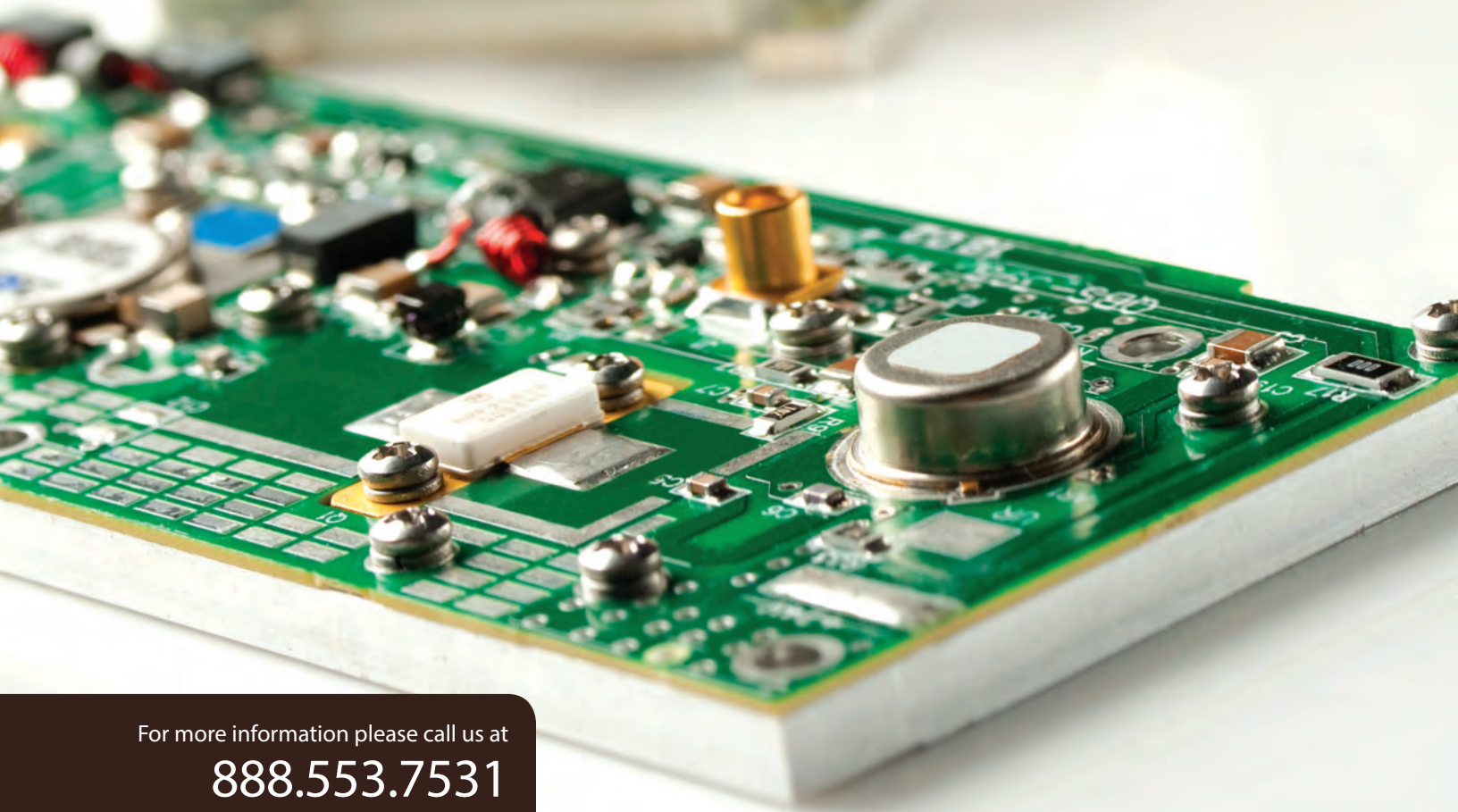

For more information please call us at

888.553.7531

Full Performance Amps

Part Number	Frequency (MHz)	Gain (dB)	P1dB (dBm)	N.F. (dB)	IP3 (dBm)	IP2 (dBm)	Rev. Iso. (dB)	Input VSWR	Output VSWR	Supply (+DC/mA)
QBH-126	5 - 500	15	16	3.8	29	35	25	1.5	1.5	15 V / 50 mA
TM5126	5 - 500	15	17	3	32	42	21	1.5	1.8	15 V / 50 mA
TM5519	5 - 500	15	14.5	2.25	29	39	18	1.5	1.9	5 V / 30 mA
TM6152	5 - 500	15	8	2.9	21	28	19	1.7	1.7	5 V / 18 mA
TM6210	5 - 500	15	8	2.9	21	28	20	1.2	1.3	5 V / 18 mA
TM6416	5 - 500	15	13.5	3.5	27	35	17	1.25	1.25	15 V / 35 mA
TM6505	5 - 500	15	10	4	23	33	18	1.25	1.75	15 V / 24 mA
TM6607	5 - 500	15	14.5	5	24	34	19	1.25	1.25	24 V / 50 mA
TM6171	5 - 500	15.2	0.5	2.3	12	15	21	1.6	1.4	15 V / 11 mA
TM6149	5 - 500	15.3	16	5	30	41	19	1.25	1.25	15 V / 45 mA
TM5119	5 - 500	15.5	16	2.3	32	44	19	1.8	1.8	15 V / 30 mA
TM6143	5 - 500	15.7	7.5	1.6	20	28	19	1.7	1.6	15 V / 14.5 mA
TM6501	5 - 500	16.5	3	2.5	15	17	20	1.5	1.5	15 V / 10 mA
TM6503	5 - 500	16.5	1.5	3.5	14	16	20	1.75	1.5	15 V / 10 mA
TM6510	5 - 500	16.5	3	2.5	15	17	20	1.5	1.5	15 V / 10 mA
TM6511	5 - 500	16.5	2	2.5	14	16	20	1.5	1.5	15 V / 10 mA
TM6533	5 - 500	16.5	17	3.5	32	42	18	1.5	1.5	15 V / 50 mA
TM6577	5 - 500	16.5	17	3.5	32	42	18	1.5	1.5	15 V / 50 mA
TM3057	5 - 500	17	19	3.8	35	44	18	1.8	1.8	15 V / 49 mA
TM6147	5 - 500	17	20	3	35	44	19	1.75	1.5	15 V / 50 mA
TM6513	5 - 500	17	16.5	3.8	29	41	19	1.5	1.8	24 V / 50 mA
TM6675	5 - 500	20.5	5	2.3	18	21	23	1.5	1.5	15 V / 15 mA
TM6512	5 - 500	21	10	2.5	21	27	22	1.5	1.25	15 V / 23 mA
TM6575	5 - 500	21	9.5	2.7	21	28	23	1.5	1.25	15 V / 23 mA
TM3075	5 - 500	22.5	10	2.4	22	26	24	1.5	1.5	12 V / 22 mA
TM6517	5 - 500	22.5	10	2.4	22	26	24	1.5	1.5	15 V / 22 mA
TM6523	5 - 500	25.5	16	5.5	26	35	33	1.3	1.3	15 V / 75 mA
TR6589	5 - 500	26.5	22	3.75	35	55	33	1.5	1.5	15 V / 130 mA
TM6576	5 - 500	28	16	5	30	52	34	1.5	1.5	15 V / 64 mA
TM6674	5 - 500	28	-1	2.5	9	17	39	1.5	1.5	5 V / 13 mA
TM6654	5 - 500	29	11	2.5	23	33	34	1.5	1.25	5 V / 40 mA
TM6521	5 - 500	30	9	3	22	30	34	1.25	1.5	15 V / 36 mA
TM6574	5 - 500	30	9	3.5	22	36	36	1.35	1.65	15 V / 37 mA
TM6721	5 - 500	30	9	3	22	37	36	1.75	1.75	15 V / 38 mA
TR3010	5 - 500	30	21.5	3.5	34	48	32	1.3	1.8	12 V / 130 mA
TM6524	5 - 500	31	15	3.5	25	30	36	1.5	1.75	15 V / 70 mA
TM6573	5 - 500	32	2	2.5	14	19	39	1.5	1.5	15 V / 20 mA
TM6719	5 - 500	33	9	1.7	20	36	42	1.75	1.5	15 V / 35 mA
TM5133	10 - 500	10	16	3.3	30	45	22	1.75	1.2	15 V / 57 mA
TM6131	10 - 500	10.3	20	4.5	37	50	22	1.3	1.3	15 V / 62 mA
TM5109	10 - 500	10.5	13	4	28	40	24	1.5	1.5	15 V / 35 mA
TM6543	10 - 500	11	11	2.5	24	35	13	1.5	1.75	15 V / 25 mA
QBH-115	10 - 500	11.5	26	9.5	35	42	25	1.5	1.5	15 V / 165 mA
TM6545	10 - 500	11.5	20.5	4	36	48	15	1.3	1.5	15 V / 60 mA
TM3092	10 - 500	12	25	6	37	44	23	1.2	1.9	15 V / 140 mA
TM5104	10 - 500	12	15	2	32	46	15	1.35	1.5	15 V / 35 mA
TM6544	10 - 500	12	15	2	32	46	15	1.4	1.5	15 V / 35 mA
QBH-215	10 - 500	12.3	26	7.8	35	42	25	1.5	1.5	15 V / 165 mA
TM5115	10 - 500	12.3	26	7.8	34	42	18	1.5	1.5	15 V / 165 mA
TM5182	10 - 500	12.5	25	6	36	45	22	1.4	1.4	15 V / 145 mA
TM5544	10 - 500	12.5	14.5	2.5	27	33	15	1.5	1.5	5 V / 35 mA
TM6547	10 - 500	12.5	19	4	35	48	17	1.8	1.5	15 V / 55 mA
TM3081	10 - 500	13	15	1.7	27	35	21	1.7	1.7	5 V / 35 mA
TM3083	10 - 500	13	15	1.7	27	35	21	1.7	1.7	15 V / 35 mA
TM6561	10 - 500	13	27	5.5	40	55	40	1.7	1.7	15 V / 150 mA
TM6661	10 - 500	13.5	27.5	5	41	48	20	1.5	1.7	15 V / 170 mA
TM6519	10 - 500	14.3	19	5.5	34	40	16	1.5	1.6	15 V / 70 mA
TM5110	10 - 500	15	10.5	2.5	25	33	21	1.5	1.5	15 V / 25 mA
TM6198	10 - 500	15	20	4.5	30	38	19	1.4	1.75	5 V / 70 mA
TM6557	10 - 500	15	15.5	4.5	30	38	18	1.2	1.25	15 V / 44 mA
TM6507	10 - 500	15.5	24	4	35	40	17	1.5	1.7	15 V / 110 mA
QBH-122	10 - 500	17	20	4.2	30	38	22	2	2	15 V / 65 mA
TM5122	10 - 500	17	20	4.2	30	38	22	1.8	1.8	15 V / 60 mA
TM3071	10 - 500	20	19.5	4	34	45	22	1.75	1.5	15 V / 75 mA

*All specifications listed are typical at 25°C.

Full Performance Amps

Part Number	Frequency (MHz)	Gain (dB)	P1dB (dBm)	N.F. (dB)	IP3 (dBm)	IP2 (dBm)	Rev. Iso. (dB)	Input VSWR	Output VSWR	Supply (+DC/mA)
TM4002	10 - 500	20	19.5	4	35	45	23	1.4	1.3	15 V / 80 mA
TM4003	10 - 500	20	19.5	4	35	45	23	1.4	1.3	5 V / 80 mA
TM6502	10 - 500	20	19.5	4	35	40	23	1.4	1.3	15 V / 80 mA
TR7216	10 - 500	25.5	20	2.5	33	44	32	1.75	1.5	12 V / 65 mA
TR7217	10 - 500	25.5	20	2.5	33	44	32	1.75	1.5	15 V / 65 mA
TM6526	10 - 500	28	21	3.5	35	50	36	1.5	1.5	15 V / 93 mA
TM6583	10 - 500	30	-1	2.3	10	13	37	1.5	1.5	5 V / 13 mA
TR6689	10 - 500	30	21.5	3.2	34	44	34	1.25	1.5	15 V / 130 mA
TM6570	10 - 500	8	17.5	2.5	35	46	10	1.85	1.5	15 V / 35 mA
TM6546	20 - 500	11.5	25	4	38	45	19	1.8	1.7	15 V / 105 mA
TM6157	20 - 500	13	22	7.5	33	45	23	1.2	1.75	15 V / 75 mA
TM5175	20 - 500	16.3	18	3	32	41	20	1.75	1.75	15 V / 45 mA
TM6681	20 - 500	17.5	9.5	3	23	28	37	1.4	1.1	15 V / 29 mA
TM6581	20 - 500	22	16	3.5	28	40	29	1.5	1.5	15 V / 27 mA
TM6582	30 - 500	23	21	3.5	33	43	29	1.5	1.25	15 V / 47 mA
TR9604	30 - 500	23	21	5	33	40	32	1.75	1.75	15 V / 125 mA
TM3027	30 - 500	24	8.5	2	19	22	27	1.75	2	15 V / 20 mA
QBH-838	50 - 500	15	1	1.7	12	16	25	2	2	15 V / 12 mA
TM3085	100 - 500	11.5	19.5	1.5	31	43	25	1.5	1.2	15 V / 90 mA
TM3031	100 - 500	13	8.5	2.2	20	29	19	1.85	1.75	3.3 V / 19.2 mA
TR3029	100 - 500	25.5	16	2.2	27	41	32	1.75	1.75	15 V / 45 mA
TR9721	200 - 500	34	22	0.8	33	43	45	2.3	1.5	15 V / 105 mA
TM5107	10 - 550	15	2	1.75	13	16	20	1.75	1.75	15 V / 9 mA
CZ8210	0.01 - 600	10	-3.5	6	7	8	15	1.75	1.75	1.8 V / 10 mA
CZ8220	0.01 - 600	10	8	6	20	26	14	1.75	1.75	3.2 V / 25 mA
CZ8230	0.01 - 600	10	16	7	25	32	14	2.5	2	4.5 V / 60 mA
TM6667	5 - 600	14	15	4	30	45	17	1.5	1.75	15 V / 33 mA
TM6180	5 - 600	16.5	18	3.4	33	45	22	1.4	1.5	15 V / 63 mA
TM6677	5 - 600	16.5	16.5	5	30	43	17	1.5	1.5	15 V / 50 mA
TM5186	10 - 600	11.5	21.5	6	34	50	23	1.3	1.8	15 V / 100 mA
TM6605	10 - 600	15.5	10	3	23	32	18.5	1.5	1.5	15 V / 24 mA
QBH-4018	50 - 600	13	26.2	6	36	46	16	1.6	1.9	15 V / 195 mA
TM6191	100 - 600	23.5	21.5	2.5	36	52	35	1.3	1.5	15 V / 95 mA
QBH-204	5 - 700	12.5	22	7	34	50	20	1.5	1.5	15 V / 95 mA
TM6659	10 - 700	10.5	22	6.5	36	46	14	1.8	1.5	15 V / 88 mA
QBH-132	15 - 700	14.8	16	6.5	29	39	27	1.7	1.7	15 V / 44 mA
TM3007	50 - 700	14.5	14	2.7	26	36	19	1.75	1.5	15 V / 27 mA
TM9019	5 - 800	27.5	24.3	3.5	36	50	38	1.6	1.6	15 V / 165 mA
TM9167	10 - 800	12.5	15.5	4.5	30	45	15	1.5	1.8	15 V / 32 mA
TM9118	10 - 800	14.7	16	4.5	26	33	19	1.5	1.5	15 V / 45 mA
TM3099	200 - 800	15	15	1.4	25	35	17	2	1.5	5 V / 70 mA
QBH-867	824 - 849	11	26	4.2	40	50	15	1.5	1.5	13 V / 130 mA
QB-761	806 - 870	23	20	3.5	32	0	39	1.5	1.5	15 V / 140 mA
TM3058	450 - 950	24.5	11.5	3.3	23	37	13	1.5	1.75	5 V / 45 mA
TM3059	450 - 950	25	14.5	3.5	27	34	30	1.75	1.8	5 V / 77 mA
QBH-2003	800 - 960	20	19	1	30	40	25	1.5	1.5	5 V / 66 mA
TM9157	0.3 - 1000	10.2	14	4.5	27	37	18	1.2	1.5	15 V / 44 mA
QBH-5819	2 - 1000	15.5	18	6	30	42	15	2	2	15 V / 84 mA
TM9333	5 - 1000	11.5	16	5	30	44	15	1.3	1.5	15 V / 48 mA
TM9106	5 - 1000	12	19	4.8	27	32	14	1.8	1.5	15 V / 70 mA
TM6176	5 - 1000	13.5	14	4	27	40	16	1.5	1.5	15 V / 38 mA
TM9107	5 - 1000	13.5	13	3.9	22	26	15	1.5	1.7	5 V / 33 mA
TM9115	5 - 1000	14.5	9.5	4	23	32	18	1.5	1.5	15 V / 24 mA
TM9101	5 - 1000	15	1	2.4	12	15	18	1.25	1.25	15 V / 9 mA
TM9102	5 - 1000	15	10	3	23	32	17	1.5	1.5	15 V / 23 mA
TM9111	5 - 1000	15	1	2.4	12	15	18	1.25	1.25	15 V / 9 mA
TM9163	5 - 1000	16	5	2.5	16	21	18	1.3	1.5	15 V / 14 mA
TM9313	5 - 1000	16	12	3.5	23	35	18	1.5	1.5	15 V / 29 mA
TM9311	5 - 1000	16.5	2	2.3	14	17	18	1.5	1.5	15 V / 10 mA
TM9312	5 - 1000	16.5	7	3	20	24	18	1.5	1.75	15 V / 18 mA
TM9363	5 - 1000	16.5	6	3	19	25	18	1.5	1.75	15 V / 16 mA
TM9511	5 - 1000	16.5	1	2.3	14	16	18	1.5	1.5	15 V / 9.5 mA
TM3068	5 - 1000	21	12.5	4	24	44	30	1.6	1.8	15 V / 55 mA
CZ8052	5 - 1000	21.5	8	6	20	44	34	1.25	1.25	15 V / 60 mA

Full Performance Amps

Part Number	Frequency (MHz)	Gain (dB)	P1dB (dBm)	N.F. (dB)	IP3 (dBm)	IP2 (dBm)	Rev. Iso. (dB)	Input VSWR	Output VSWR	Supply (+DC/mA)
CZ8050	5 - 1000	22.5	10	6	23	42	31	1.5	1.75	15 V / 67 mA
TM9321	5 - 1000	23	14	4.2	27	45	32	1.6	1.6	15 V / 64 mA
TM9054	5 - 1000	24	11	3.5	24	38	33	1.5	1.5	5 V / 40 mA
TM6182	5 - 1000	28.5	15	2.7	22	31	36	1.5	1.5	15 V / 44 mA
TM5814	10 - 1000	10.5	25	8	33	40	14	1.8	1.8	15 V / 150 mA
TM9143	10 - 1000	10.5	10	2.5	27	38	11	1.5	1.75	15 V / 25 mA
TM9165	10 - 1000	10.5	11	4.5	24	37	15	1.5	1.5	15 V / 30 mA
TM6145	10 - 1000	10.7	19	3	35	46	12	1.5	2.5	15 V / 50 mA
TM9319	10 - 1000	11.5	22	5.5	35	46	18	1.75	1.5	15 V / 90 mA
QBH-5169	10 - 1000	12	20	7	34	49	13	2	2	15 V / 105 mA
TM9117	10 - 1000	12	15.5	4	28	40	14	1.5	1.5	15 V / 46 mA
TM9182	10 - 1000	12	26	5.5	35	42	12	1.8	1.8	15 V / 150 mA
QBH-1423	10 - 1000	13	28	6	34	46	17	1.5	1.5	15 V / 195 mA
QBH-1424	10 - 1000	13	26	5.5	32	39	17	1.5	1.5	15 V / 155 mA
QBH-1505	10 - 1000	13	28	6	34	40	17	1.5	1.5	12 V / 195 mA
TM9144	10 - 1000	13	13	3	25	35	16	1.5	1.5	15 V / 30 mA
TM9512	10 - 1000	13	21	4.5	35	45	15	1.5	1.5	12 V / 90 mA
TM9723	10 - 1000	13	27	4	40	48	18	1.75	1.5	15 V / 185 mA
TM9753	10 - 1000	13.5	27	2.5	38	45	20	1.5	1.5	15 V / 124 mA
TM9318	10 - 1000	14.7	16	3.8	30	42	18	1.5	1.5	15 V / 47 mA
TM9518	10 - 1000	14.7	16	4	29	41	17	1.5	1.5	15 V / 44 mA
TM9112	10 - 1000	16	11	3	23	28	17	1.5	1.7	15 V / 22 mA
QBH-828	10 - 1000	16.3	19.5	4.8	30	45	16	1.5	1.5	15 V / 110 mA
TM9369	10 - 1000	24.5	21.5	4	34	50	36	1.5	1.5	15 V / 130 mA
TR9169	10 - 1000	25.5	21	4	33	48	32	1.45	1.7	15 V / 125 mA
TM9113	10 - 1000	26	10	3	22	40		1.5	1.5	5 V / 34 mA
TM9566	10 - 1000	26	0.5	3	12	21	35	1.5	1.75	15 V / 18 mA
TM9366	10 - 1000	27.5	15	4	25	32	36	1.5	1.5	15 V / 63 mA
TM6183	10 - 1000	29	15	4	25	32	36	1.5	1.5	15 V / 70 mA
TR9666	10 - 1000	37	15.5	3.5	25	31	52	1.5	1.6	15 V / 82 mA
TM9119	10 - 1000	9	21	8.5	34	40	13	1.5	1.5	15 V / 100 mA
QBH-147	20 - 1000	13.5	10	3.5	23	33	22	1.5	1.5	15 V / 27 mA
TM3033	30 - 1000	11.5	22	4	36	45	18	1.75	1.5	15 V / 90 mA
QBH-5847	30 - 1000	9	10	4.8	23	33	22	1.8	1.8	15 V / 27 mA
TM9105	50 - 1000	11	21	4.5	35	45	15	1.5	1.5	15 V / 90 mA
TM3063	50 - 1000	24	10	3.75	23	40	19	1.5	1.75	5 V / 40 mA
TM3055	300 - 1000	12	18.5	4.3	29	42	12	1.75	2.25	15 V / 50 mA
TM3034	300 - 1000	12.5	19.5	2.5	30	43	19	1.75	2	15 V / 56 mA
TM6155	300 - 1000	12.5	19.5	4	33	45	13	1.5	2	15 V / 50 mA
TM3030	500 - 1000	15	16.5	4.5	28	35	17	1.5	1.5	15 V / 47 mA
TR3020	500 - 1000	21.5	28	4.4	39	42	35	1.8	1.5	15 V / 255 mA
CZ8330	kHz - 1000	6.2	14	9.5	25	37	14	2.5	2.5	4.5 V / 60 mA
CZ8310	kHz - 1000	8	-1.5	7	7	13	13	2.5	2.5	1.6 V / 10 mA
CZ8320	kHz - 1000	9	8	7	20	33	13	1.75	1.5	2.75 V / 25 mA
TM3037	1030 - 1090	13.5	19.5	2	31	45	21	1.5	1.95	5 V / 78 mA
TM9359	5 - 1100	13.5	27	5	40	43	18	1.5	1.7	15 V / 175 mA
TM6345	10 - 1100	12.3	17	3	33	46	13	1.5	1.8	15 V / 45 mA
TM5147	20 - 1100	14	11	3.5	23	33	18	1.6	1.6	15 V / 27 mA
TM5347	20 - 1100	14	11	3.5	23	33	18	1.6	1.6	12 V / 27 mA
TM9316	10 - 1200	13	6	3	19	28	16	1.25	1.35	15 V / 15 mA
TM9269	10 - 1200	22	21	4.5	35	50	36	1.7	1.7	15 V / 130 mA
TM3042	10 - 1200	23	19	3	32	40	30	1.2	1.5	15 V / 75 mA
TM9166	10 - 1200	23.5	15	4.5	28	46	30	1.5	1.5	15 V / 64 mA
TM9164	10 - 1200	26	8.5	3.6	20	33	34	1.6	1.5	15 V / 35 mA
QBH-5128	20 - 1200	25.5	13	4.5	28	41	28	2	2	15 V / 70 mA
TM5154	200 - 1200	12.8	8	2.6	21	31	23	1.5	1.5	15 V / 23 mA
TM3001	400 - 1200	15	10	3	21	30	16	1.5	1.5	5 V / 19 mA
TM3003	800 - 1200	17.5	19.5	5.5	30	41	28	1.75	1.75	15 V / 115 mA
TR9770	800 - 1200	25	14	1	25	40	38	1.8	1.8	15 V / 62 mA
TR9755	800 - 1200	26	14	1	25	40	38	1.8	1.8	5 V / 62 mA
TM3021	750 - 1250	16	11.5	4.5	22	38	35	1.75	1.75	15 V / 65 mA
QBH-131	5 - 1300	18	7	5	20	35	27	1.5	1.5	15 V / 41 mA
TM5131	5 - 1300	18	7.5	5	20	40	29	1.5	1.6	15 V / 40 mA
TM6212	10 - 1300	10	22.5	6	34	42	16	1.6	1.4	15 V / 92 mA

*All specifications listed are typical at 25°C.

Full Performance Amps

Part Number	Frequency (MHz)	Gain (dB)	P1dB (dBm)	N.F. (dB)	IP3 (dBm)	IP2 (dBm)	Rev. Iso. (dB)	Input VSWR	Output VSWR	Supply (+DC/mA)
TM3019	500 - 1300	13.5	22	2.2	36	50	21	1.75	1.5	15 V / 105 mA
TM3100	500 - 1300	30	16	3.5	28	38	40	1.8	1.8	15 V / 80 mA
TM3022	700 - 1300	21	13	3.5	23	32	35	1.75	1.75	15 V / 65 mA
TR3096	700 - 1300	25	24	4	24	32	33	1.5	1.5	15 V / 120 mA
TM9769	10 - 1400	12.5	23	2.5	36	49	20	1.5	1.7	15 V / 100 mA
TM9502	5 - 1500	10.5	9	4	24	32	13	1.5	1.5	15 V / 23 mA
TM9522	5 - 1500	20.5	14	5	25	42	30	1.5	1.5	15 V / 64 mA
TM3067	10 - 1500	10.5	21	5	30	36	17	1.75	1.75	15 V / 85 mA
TM9125	10 - 1500	10.5	8	4.5	21	33	15	1.5	1.75	15 V / 24 mA
TM9128	10 - 1500	11.5	15	4.5	29	43	14	1.5	1.5	15 V / 40 mA
TM9123	10 - 1500	12	4	4	17	22	16	1.75	1.75	15 V / 14 mA
QBH-817	10 - 1500	13.5	20	6.5	30	42	13	1.5	1.5	15 V / 105 mA
TM3088	10 - 1500	14	22.5	2.8	36	45	20	1.5	1.5	15 V / 95 mA
TM5817	10 - 1500	14	23	6	32	44	20	1.5	1.75	15 V / 98 mA
TM9325	10 - 1500	14	9	3.5	22	30	17	1.5	1.75	15 V / 24 mA
TM9328	10 - 1500	14	12	3.25	23	31	16	1.6	1.6	5 V / 27 mA
TM9121	10 - 1500	15	13.5	4	26	34	16	1.75	1.75	15 V / 34 mA
TM9114	10 - 1500	20	8	4	21	42	32	1.4	1.4	12 V / 34 mA
TM9124	10 - 1500	20	8	4	21	42	32	1.4	1.4	15 V / 34 mA
TM9126	10 - 1500	20.5	15	5	28	45	30	1.5	1.5	15 V / 64 mA
TM9524	10 - 1500	22	13	4.3	23	31	33	1.8	1.8	15 V / 56 mA
QBH-5866	10 - 1500	27.5	13.5	6	26	38	38	2	2	15 V / 85 mA
TM9129	10 - 1500	8	20.5	8	34	42	15	1.5	1.5	15 V / 95 mA
TM9127	10 - 1500	9	16	6	32	42	11	1.5	1.75	15 V / 52 mA
TM9329	10 - 1500	9	20	6.5	30	36	11	1.8	1.8	15 V / 90 mA
TM9529	10 - 1500	9.5	20	4	39	48	16	1.5	1.5	12 V / 90 mA
TM9702	500 - 1500	12	19.8	3	32	40	18	1.5	1.5	8 V / 105 mA
TM3052	1200 - 1600	11	23	4	35	46	17	1.75	1.75	15 V / 90 mA
TM3014	1200 - 1600	23	24	2.5	36	54	38	1.75	1.5	15 V / 145 mA
TM3053	1200 - 1600	9	22	4	36	45	16	1.75	1.75	15 V / 90 mA
TM3086	1400 - 1600	16	19	1	33	42	22	1.6	1.2	15 V / 60 mA
TM3013	10 - 1700	14	23	6	35	50	20	1.8	1.5	15 V / 100 mA
TM3049	10 - 1700	8.5	27	6.2	40	48	13	1.85	1.75	15 V / 170 mA
TR9756	1200 - 1700	27	15	1	26	40	38	1.8	1.8	5 V / 60 mA
TR9771	1200 - 1700	27	15	1	26	40	38	1.8	1.8	15 V / 60 mA
TM3101	1200 - 1700	30	20	1.8	30	40	37	1.75	1.75	5 V / 105 mA
TM3102	1200 - 1700	30	20	2	30	40	37	1.75	1.75	15 V / 110 mA
TM6153	300 - 1800	11.5	7	3	18	22	17	2.5	2	15 V / 18 mA
TM3095	1200 - 1800	11	18.5	2.8	30	40	16	1.5	1.5	15 V / 85 mA
TM3073	1400 - 1800	15	17	2.5	28	38	21	1.7	1.7	15 V / 63 mA
TM3074	1400 - 1800	16	17	1.5	28	38	22	1.7	1.7	5 V / 63 mA
TM9352	5 - 2000	10	8	4	20	28	13	1.5	1.75	5 V / 18 mA
TM9355	5 - 2000	10	11	4	24	32	16	1.8	1.5	5 V / 30 mA
TM9138	10 - 2000	7.5	19	6	33	46	10	1.8	1.5	15 V / 65 mA
TM9139	10 - 2000	8	24	8	35	42	15	1.5	1.75	15 V / 90 mA
TM9323	10 - 2000	8.5	15	5.5	30	42	13	1.75	1.75	15 V / 50 mA
TM9133	10 - 2000	9.5	3	4.5	16	23	15	1.5	1.5	15 V / 14 mA
TM9137	10 - 2000	9.5	15.5	6.5	28	38	9	1.8	1.5	15 V / 45 mA
TM9720	10 - 2000	9.5	18.5	2.8	30	40	16	1.5	1.5	15 V / 70 mA
QBH-4009	10 - 2000	10	25.5	4.5	39	46	16	2	2	15 V / 195 mA
QBH-5409	10 - 2000	10	25.5	4.5	39	46	16	2	2	15 V / 195 mA
TM9135	10 - 2000	10	9	5	23	35	16	1.5	1.5	15 V / 25 mA
TM9322	10 - 2000	10	9	5	23	35	16	1.5	1.5	15 V / 25 mA
QBH-816	10 - 2000	10.2	20	8.5	30	40	11	1.6	1.6	15 V / 120 mA
TM9709	10 - 2000	10.5	27	4.5	39	48	18	1.75	1.75	15 V / 180 mA
TM9714	10 - 2000	11	27	4.5	39	48	18	1.75	1.75	12 V / 180 mA
TM9331	10 - 2000	11.5	2	4	14	21	15	1.5	1.5	15 V / 11 mA
TM9326	10 - 2000	15	20.5	6.5	31	45	30	1.8	1.8	15 V / 110 mA
TM9327	10 - 2000	15	17.5	6.5	29	38	27	1.3	1.5	15 V / 108 mA
TR9327	10 - 2000	15	17.5	6.5	29	38	27	1.3	1.5	15 V / 108 mA
TM9324	10 - 2000	16	6.5	4.75	19	37	28	1.5	1.8	15 V / 38 mA
TM9136	10 - 2000	17	12	5.5	22	42	26	1.5	1.5	15 V / 63 mA
TM9266	10 - 2000	17	14.5	4.5	27.5	43	26	1.8	1.8	15 V / 75 mA
TM6184	10 - 2000	19.5	11	4.5	23	37	30	1.75	1.75	15 V / 54 mA

Full Performance Amps

Part Number	Frequency (MHz)	Gain (dB)	P1dB (dBm)	N.F. (dB)	IP3 (dBm)	IP2 (dBm)	Rev. Iso. (dB)	Input VSWR	Output VSWR	Supply (+DC/mA)
QBH-822	10 - 2000	20	11	5	24	35	24	2	2	15 V / 60 mA
TM5822	10 - 2000	20	11	5	24	35	30	1.75	1.75	15 V / 57 mA
TM3015	10 - 2000	20.5	13	6	25	40	30	2	2.25	18 V / 68 mA
QBH-5407	50 - 2000	10	26	6	38	46	20	2	2	15 V / 225 mA
QBH-4007	50 - 2000	10	27	6	38	46	20	2	2	15 V / 225 mA
TM3079	50 - 2000	19.5	13	4	25	40	35	1.8	1.8	5 V / 70 mA
TM3094	50 - 2000	19.5	14	4	27	46	35	1.8	1.8	5 V / 70 mA
TM9134	100 - 2000	16.5	6	4.5	16	33	28	1.5	1.75	15 V / 35 mA
QBH-4012	100 - 2000	19.5	23	3.2	33	52	35	1.5	1.8	15 V / 190 mA
TR9737	100 - 2000	9.5	24	4.5	38	49	14	1.75	1.75	15 V / 140 mA
TM6238	200 - 2000	10	23	4	35	56	19	1.7	1.5	15 V / 150 mA
TM9738	200 - 2000	11	25.5	4	39	46	19	1.5	1.5	15 V / 140 mA
TM9700	200 - 2000	12	17.5	2.2	29	35	18	1.8	1.3	6 V / 62 mA
TM9701	200 - 2000	12	14	3	25	32	16	1.5	1.5	5 V / 48 mA
TM9030	300 - 2000	14	25	4	32	50	19	1.8	1.8	12 V / 150 mA
TM9713	500 - 2000	11	21	4.5	34	44	17	1.75	1.5	15 V / 100 mA
TM9715	500 - 2000	11	25	4.5	40	49	19	2	1.5	12 V / 180 mA
TM9725	500 - 2000	11	26.5	4.5	38	45	19	1.5	1.5	15 V / 165 mA
TM9712	500 - 2000	11.5	16	3.5	26	35	18	1.75	1.5	15 V / 45 mA
TR3070	500 - 2000	22	24.5	3.3	35	45	22	1.5	1.5	12 V / 200 mA
TM3077	900 - 2000	12.5	26	3.75	41	47	21	1.5	1.75	12 V / 160 mA
TM9711	1000 - 2000	12	16	2.2	29	35	18	1.75	1.5	6 V / 62 mA
TR3069	1000 - 2000	14.5	19	2.2	31	41	21	2.3	1.7	12 V / 65 mA
TM9708	10 - 2100	11.5	24.5	3.6	40	60	20	1.2	1.5	15 V / 165 mA
TR9466	30 - 2100	19	20.5	3	32	45	30	1.5	1.75	15 V / 125 mA
TM3076	800 - 2200	12.5	27	3.5	40	45	19	1.5	1.5	15 V / 175 mA
QBH-2001	1800 - 2200	14	17	1	32	36	18	1.5	1.5	5 V / 66 mA
TM9336	100 - 2300	17.5	14	4.5	25	35	30	1.5	1.5	15 V / 80 mA
TM9302	1700 - 2300	10.5	11	5	23	40	13	1.75	1.5	15 V / 18 mA
TM3002	1400 - 2400	12	26	4	37	46	18	2.25	1.5	15 V / 150 mA
TM9730	1400 - 2400	12	26	4	37	46	18	2.25	1.5	15 V / 150 mA
TR9757	1700 - 2400	23	15	1.5	26	40	33	1.5	1.5	5 V / 60 mA
TR9772	1700 - 2400	23	15	1.5	26	40	35	1.8	1.8	15 V / 65 mA
QBH-4010	10 - 2500	7.5	26	6.5	36	44	11	2	2	15 V / 190 mA
TM9759	10 - 2500	8.5	27.5	4.3	40	52	22	1.6	1.6	15 V / 185 mA
TM9704	100 - 2500	18	18	3.5	28	42	35	1.75	1.5	15 V / 88 mA
TR9789	100 - 2500	20	28	3.5	41	55	35	1.5	1.5	15 V / 230 mA
TM9270	500 - 2500	17.5	20	1.3	33	47	23	1.5	1.25	5 V / 65 mA
QBH-4008	1100 - 2500	10	27	6	40	50	20	2.0	2.0	15 V / 225 mA
TM3018	2000 - 2500	11	21.5	4	39	51	22	1.25	1.5	15 V / 98 mA
TM9740	2000 - 2500	11	21.5	4	39	51	22	1.25	1.5	15 V / 98 mA
TM9777	10 - 2700	11	23	3.3	37	46	20	1.75	1.75	15 V / 115 mA
TM9308	10 - 3000	10.5	26	4	35	53	20	1.6	1.5	15 V / 176 mA
QBH-4013	30 - 3000	19	15	4	25	38	30	1.7	1.5	15 V / 90 mA
TM3080	100 - 3000	20	19	5	34	42	20	2.2	2.2	5 V / 95 mA
TM3078	200 - 3000	10	10.5	4	34	42	17	1.7	1.5	5 V / 30 mA
QBH-4002	200 - 3000	11	12	4	24	30	17	2.0	2.0	15 V / 75 mA
BXMP1036	500 - 3000	30	25	2	40	55	37	1.75	1.75	15 V / 280 mA
BXMP1035	500 - 3000	38	24.5	1.6	40	50	55	1.8	1.8	15 V / 220 mA
QBH-5404	2000 - 3000	15.5	22	1.5	33	43	24	1.3	1.3	8 V / 85 mA
BXMP1007	2400 - 3600	19.5	22.5	4	33	52	50	1.6	1.35	15 V / 145 mA

*All specifications listed are typical at 25°C.

For more information please call us at

888.553.7531

A woman with long blonde hair, wearing a blue lab coat, is looking through the eyepieces of a white and blue microscope. She is holding a small component on a microscope stage with a tool. The background is bright and out of focus. The microscope has a label that reads "REL. EQUIPMENT E1868" and "SZ11".

High Quality

Our thick and thin film amplifiers are designed and tested to meet the reliability and testing requirements of MIL-PRF-38534 and the screening requirements of MIL-STD-883. We are also equipped to perform Groups A, B, C and D QCI qualification of our hybrid microelectronic devices. We routinely perform MIL-PRF-38534 Class H qualification testing on many of our amplifiers thereby proving out the high reliability designs API Technologies is known for in the industry.

Hybrid Production Process

START

Inspection of All Incoming Material

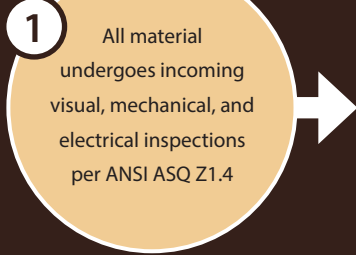

Assembly and Wire Bond

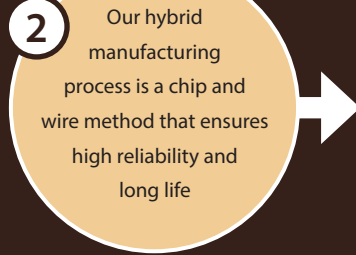

100% Initial Electrical Test

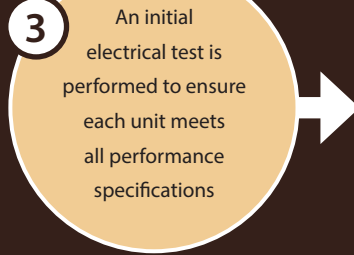

100% Quality Control Internal

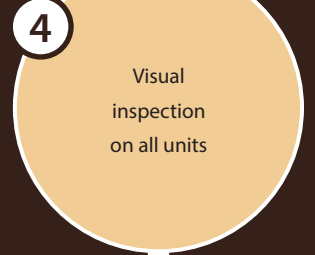

Constant Acceleration

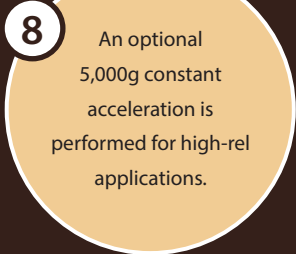

Temperature Cycling (-65°C to +150°C)

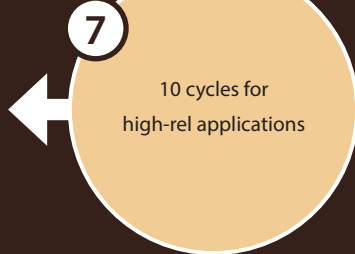

Hermetic Seal

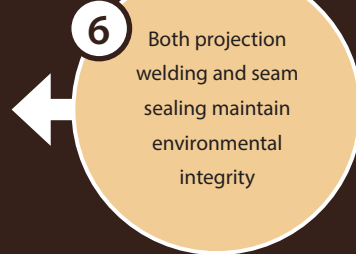

Vacuum Bake



Hermetic Seal Tests

All parts must pass both a fine and gross leak test before branding

As part of our ISO9001 hybrid amplifier manufacturing process, all parts are tested multiple times during the production cycle to ensure part-to-part and lot-to-lot reliability... every time.

Branding



Electrical Test

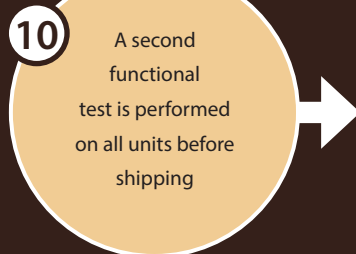

Final Quality Control Inspection

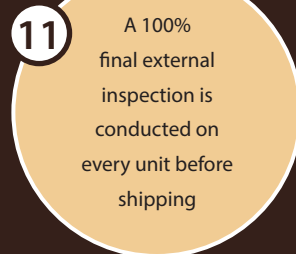

FINISH

| Environmentals |

Seam Sealing

API Technologies inventory of sealing alternatives includes both seam sealing and projection welding which provide a very reliable hermetic seal, while maintaining a cool, stable environment for the package and its temperature sensitive contents. Hermetic sealing also maintains environmental integrity to pass the rigors of MIL-PRF-38534 methods 1014 conditions A & C for both Gross and Fine leak detection.



Laser Sealing

Unlike other amplifier companies, API Technologies offers laser sealing for both hermetic and environmental integrity.

Vibration Testing

On-site random and sinusoidal vibration to 30g, along with shock testing allow our engineers to test their designs under extreme conditions.

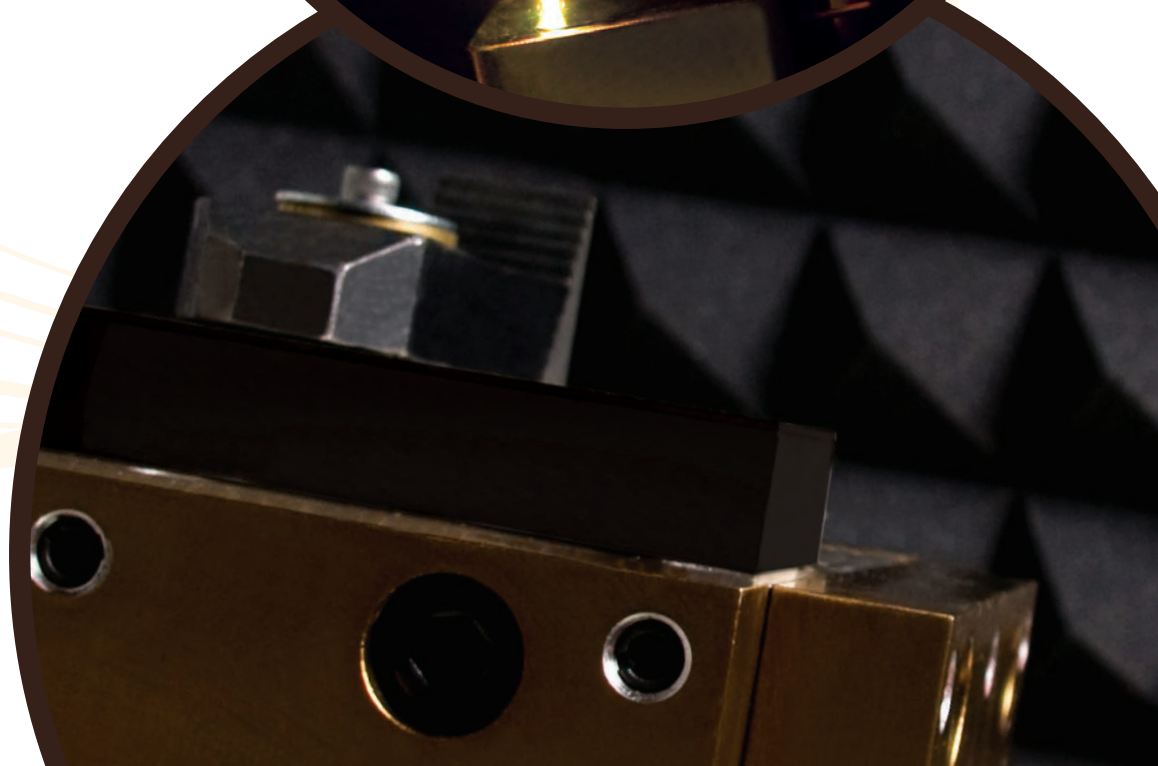

Extreme Temperature Cycling

As part of our pursuit for 100% total satisfaction, API Technologies components undergo a number of thermal stress tests. For example, components from our hybrid operations undergo up to 10 cycles taking the components from -65°C to $+125^{\circ}\text{C}$. In addition, all components undergo a 150°C vacuum bake in order to screen out any parts which did not meet our high quality standards.





TO-8

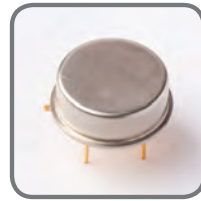
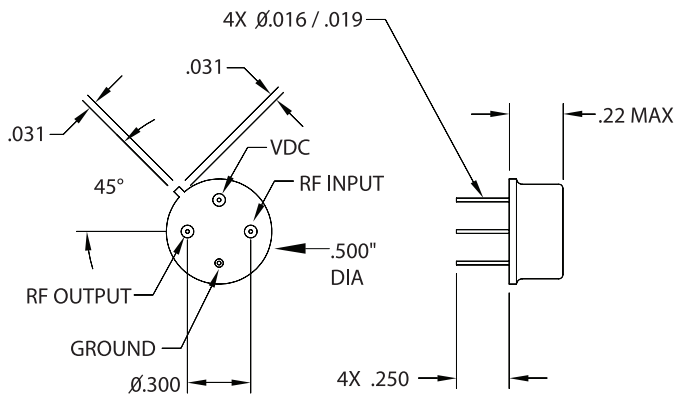

TO-8B

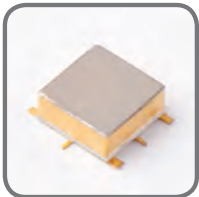
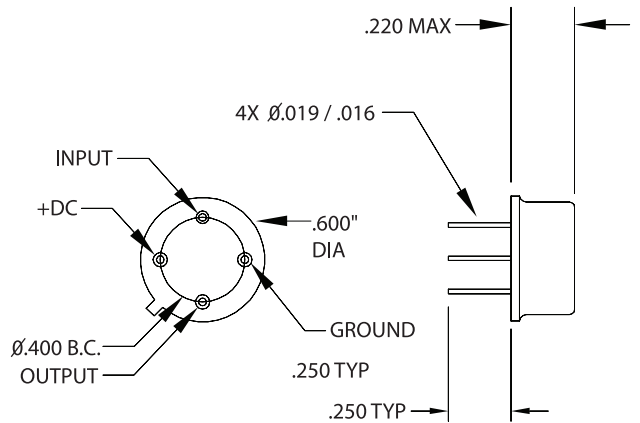

0.375" Sq. Surface Mount

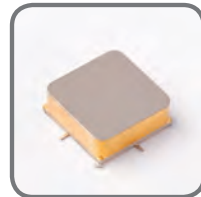
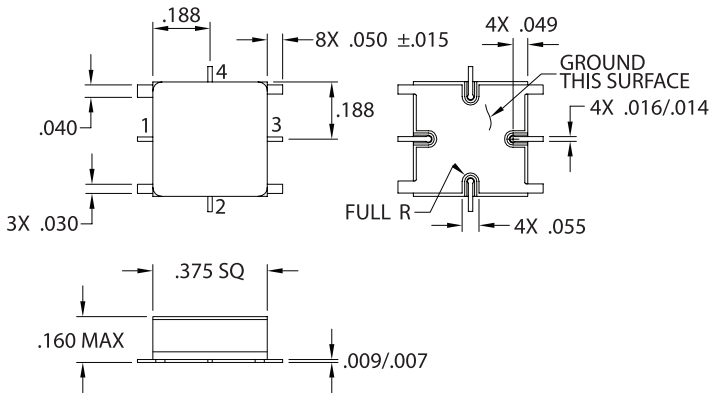

0.450" Sq. Surface Mount

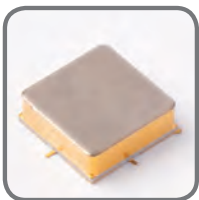
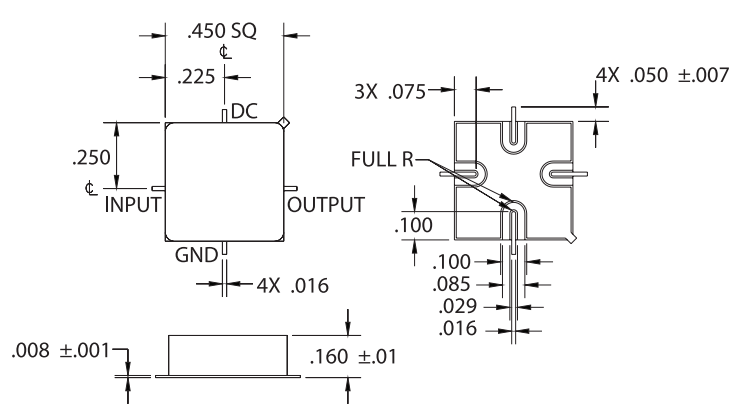

0.525" Sq. Surface Mount

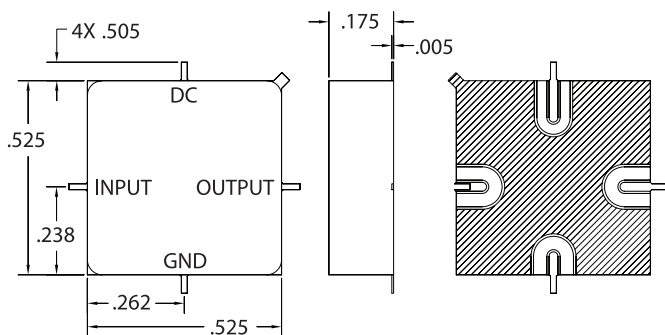

Block Amplifier

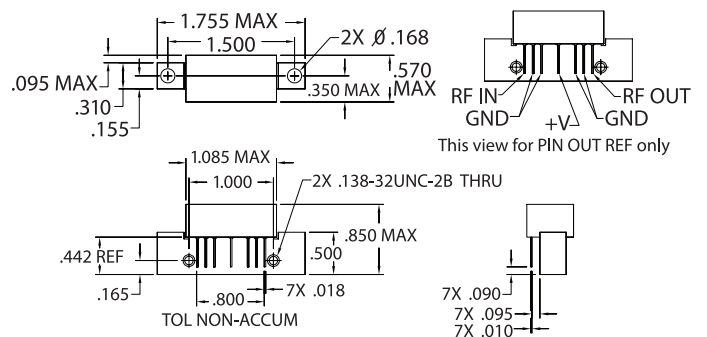

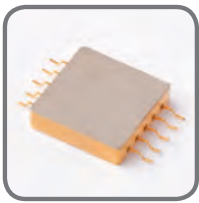

0.625" Sq. Gullwing

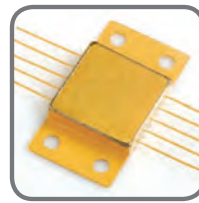
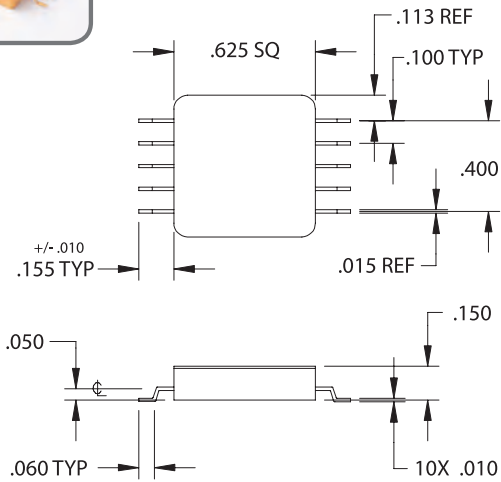

0.625" Sq. Flatpack Flanged

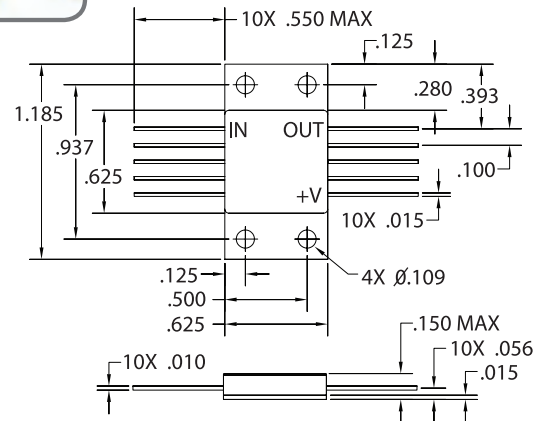

Higher Volume Package

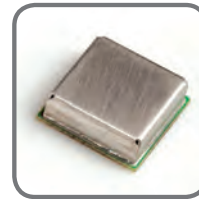
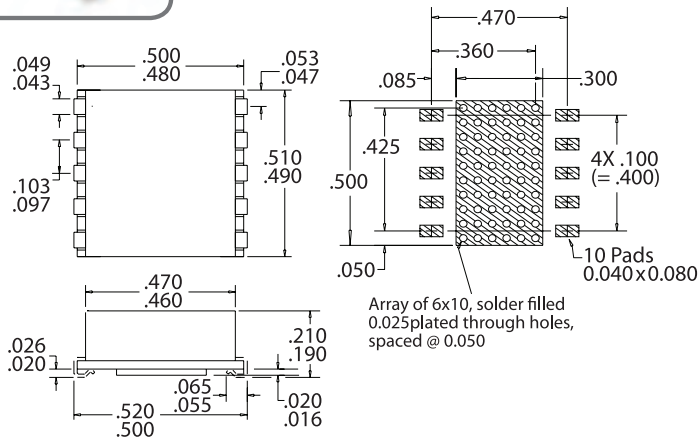

Generation II Package

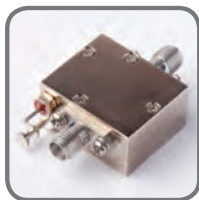
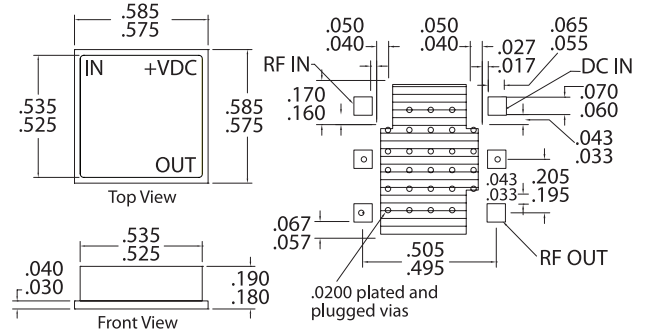

SMA Connectorized (TO-8)

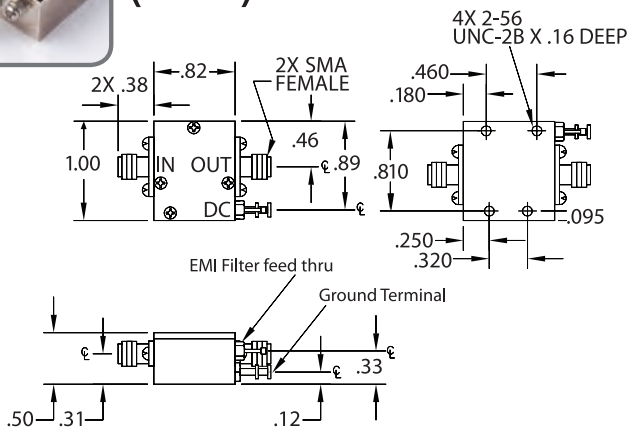

SMA Connectorized (TO-8B)

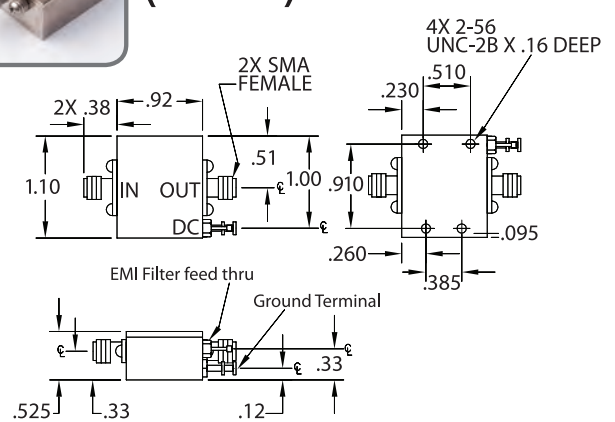

*Note: Dimensions in inches (mm). Illustrations noted here are for reference only.
For a list of controlled outline drawings and other popular packages, please refer to micro.apitech.com

| Design Resources |



micro.apitech.com

API Technologies' website features complete information on all standard products with updated versions of more than 900 product datasheets. API's customers enjoy FREE engineering tools, tours, application notes, white papers, and the ability to create a custom designed product per individual specifications.

Cascade Design Suite

With over 750 datasheets on API Technologies' Amplifiers, Mixers, Oscillators & Control Products, this CD also offers the industry's best manufacturer's cross reference. The System Simulator lets you optimize your design by viewing an individual component's contribution to overall system performance. You can also quickly evaluate trade-offs in component selection and their impact on system performance (e.g. Gain, Noise, P1dB, IP3, Dynamic Range,.....)

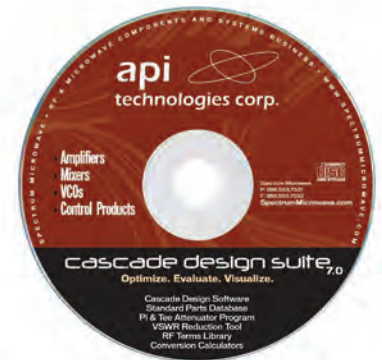

api

technologies corp.

API Technologies Corp. is a trusted provider of RF/microwave, microelectronics, and security solutions for critical and high-reliability applications. The company designs, develops and manufactures electronic components, modules, systems and products for technically demanding defense, commercial/industrial and aerospace applications. API Technologies' customers include many leading Fortune 500 companies, as well as a majority of NATO governments. While API was founded in 1981, our heritage brands have served the demanding, hi-rel marketplace for more than 60 years. API Technologies trades on the NASDAQ under the symbol ATNY.

www.apitech.com • +1.855.294.3800